

TPS6128xA Low-, Wide- Voltage Battery Front-End DC/DC Converter

Single-Cell Li-Ion, Ni-Rich, Si-Anode Applications

1 Features

- 95% Efficiency at 2.3MHz Operation
- 3 μ A Quiescent Current in Low I_Q Pass-Through Mode
- Wide V_{IN} Range From 2.3V to 4.8V
- I_{OUT} \geq 4A (Peak) at V_{OUT} = 3.35V, V_{IN} \geq 2.65V
- Integrated Pass-Through Mode (35m Ω)
- Programmable Valley Inductor Current Limit and Output Voltage
- True Pass-Through Mode During Shutdown
- *Best-in-Class* Line and Load Transient
- Low-Ripple Light-Load PFM Mode
- In-Situ Customization with On-Chip E²PROM (Write Protection)
- Two Interface Options:
 - I²C Compatible I/F up to 3.4Mbps (TPS61280A)
 - Simple I/O Logic Control Interface (TPS6128xA)
- Thermal Shutdown and Overload Protection
- Total Solution Size < 20mm², Sub 1-mm Profile

2 Applications

- Single-Cell Ni-Rich, Si-Anode, Li-Ion, LiFePO₄ Smart-Phones or Tablet PCs
- 2.5G/3G/4G Mini-Module Data Cards
- Current Limited Applications Featuring High Peak Power Loads

4 Simplified Schematic

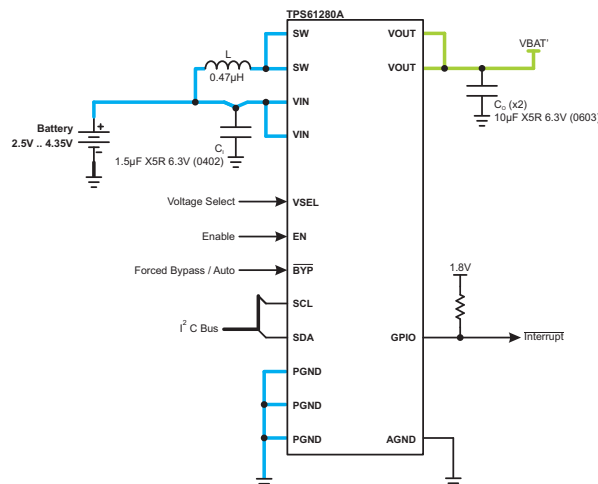

3 Description

The TPS6128xA device provides a power supply solution for products powered by either by a Li-Ion, Nickel-Rich, Silicon Anode, Li-Ion or LiFePO₄ battery. The voltage range is optimized for single-cell portable applications like in smart-phones or tablet PCs.

Used as a high-power pre-regulator, the TPS6128xA extends the battery run-time and overcomes input current- and voltage limitations of the powered system.

While in shutdown, the TPS6128xA operates in a true pass-through mode with only 3 μ A quiescent consumption for longest battery shelf life.

During operation, when the battery is at a good state-of-charge, a low-ohmic, high-efficient integrated pass-through path connects the battery to the powered system.

If the battery gets to a lower state of charge and its voltage becomes lower than the desired minimum system voltage, the device seamlessly transits into boost mode to uses the full battery capacity.

Device Information⁽¹⁾

PART NUMBER	PACKAGE	BODY SIZE (NOM)
TPS61280A	DSBGA (16)	1.66 mm x 1.66 mm
TPS61281A		
TPS61282A		

(1) For all available packages, see the orderable addendum at the end of the datasheet.



Table of Contents

1 Features	1	10.5 Programming.....	22
2 Applications	1	10.6 Register Maps.....	25
3 Description	1	11 Application and Implementation	33
4 Simplified Schematic	1	11.1 Application Information.....	33
5 Revision History	2	11.2 Typical Application	34
6 Device Comparison Table	3	12 Power Supply Recommendations	46
7 Description (continued)	3	13 Layout	46
8 Pin Configurations and Functions	4	13.1 Layout Guidelines	46
9 Specifications	6	13.2 Layout Example	46
9.1 Absolute Maximum Ratings	6	13.3 Thermal Information.....	47
9.2 ESD Ratings.....	6	14 Device and Documentation Support	48
9.3 Recommended Operating Conditions.....	6	14.1 Device Support.....	48
9.4 Thermal Information	7	14.2 Related Links	48
9.5 Electrical Characteristics.....	7	14.3 Receiving Notification of Documentation Updates	48
9.6 I ² C Interface Timing Characteristics	9	14.4 Community Resources.....	48
9.7 I ² C Timing Diagrams.....	11	14.5 Trademarks	48
9.8 Typical Characteristics.....	12	14.6 Electrostatic Discharge Caution.....	48
10 Detailed Description	14	14.7 Glossary	48
10.1 Overview	14	15 Mechanical, Packaging, and Orderable	
10.2 Functional Block Diagram	15	Information	49
10.3 Feature Description.....	16	15.1 Package Summary.....	49
10.4 Device Functional Modes.....	17	15.2 Chip Scale Package Dimensions.....	49

5 Revision History

NOTE: Page numbers for previous revisions may differ from page numbers in the current version.

Changes from Revision A (September 2014) to Revision B	Page
• Moved Storage temperature spec, T _{stg} from Handling Ratings table to Abs Max Ratings table; and, re-named Handling ratings to ESD Ratings	6
• Changed the device number in Figure 11 From TPS61281 and TPS61282 To: TPS61281A and TPS61282A	12
• Changed the device number in Figure 24 through Figure 26 From TPS6128x To: TPS6128xA.....	24
• Added legal Note at Application and Implementation section.	33
• Added cross reference to the <i>Third-Party Products Disclaimer</i>	37
• Corrected legend for Figure 30 , Gray is V _{IN} = 3.0 V, Red is V _{IN} = 2.5 V.	38
• Added cross reference to <i>Third-Party Products Disclaimer</i>	42
• Changed the markings on Figure 67	49

Changes from Original (May 2014) to Revision A	Page
• Changed the Device Information table Package From: DGBA To: DSBGA	1
• Deleted the Package Marking Chip Code column from the Device Comparison Table. The information is found in the POA at the end of the datasheet.....	3

6 Device Comparison Table

PART NUMBER ⁽¹⁾	DEVICE SPECIFIC FEATURES	
TPS61280A	I ² C Control Interface User Prog. E ² PROM Settings	DC/DC boost / bypass threshold = 3.15V (Vsel = L)
		DC/DC boost / bypass threshold = 3.35V (Vsel = H)
		Valley inductor current limit = 3A
TPS61281A	Simple Logic Control Interface	DC/DC boost / bypass threshold = 3.15V (Vsel = L)
		DC/DC boost / bypass threshold = 3.35V (Vsel = H)
		Valley inductor current limit = 3A
TPS61282A	Simple Logic Control Interface	DC/DC boost / bypass threshold = 3.3V (Vsel = L)
		DC/DC boost / bypass threshold = 3.5V (Vsel = H)
		Valley inductor current limit = 4A

(1) The 'A' version has lower ripple and overshoot, supports Forced PWM at startup but with a 0.4 μ A higher I_Q .

7 Description (continued)

TPS6128xA device supports more than 4A pulsed load current even from a deeply discharged battery. In this mode of operation, the TPS6128xA enables the utilization of the full battery capacity: A high battery-cut-off voltage originated by powered components with a high minimum input voltage is overcome; new battery chemistries can be fully discharged; high current pulses forcing the system into shutdown are buffered by the device seamlessly transitioning between boost and by-pass mode back and forth.

This has significant impact on the battery on-time and translates into either a longer use-time and better user-experience at an equal battery capacity or into reduced battery costs at similar use-times.

The TPS6128xA offers a small solution size ($< 20\text{mm}^2$) due to minimum amount of external components, enabling the use of small inductors and input capacitors, available as a 16-pin chip-scale package (CSP).

The TPS6128xA operates in synchronous, 2.3MHz boost mode and enters power-save mode operation (PFM) at light load currents to maintain high efficiency over the entire load current range.

8 Pin Configurations and Functions

TPS61280A
16-Bump DSBGA
YFF Package

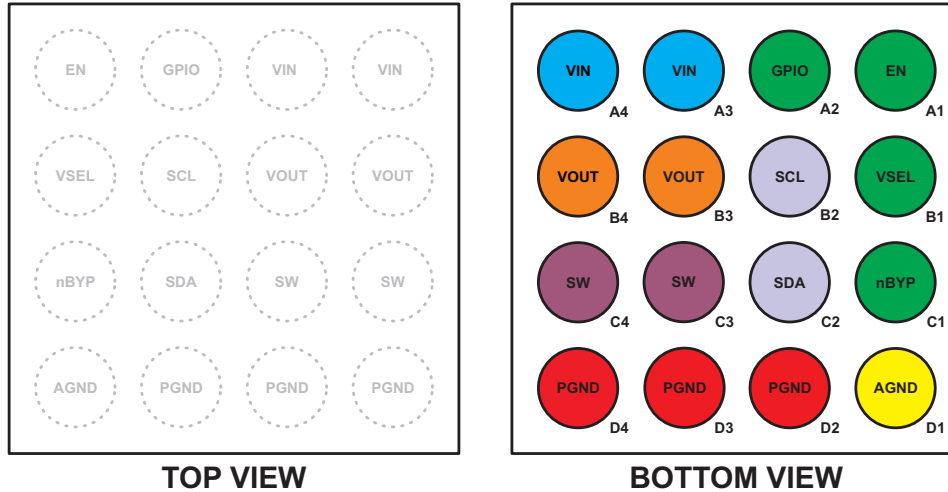

Pin Functions - TPS61280A

PIN		I/O	DESCRIPTION
NAME	NO.		
VIN	A3, A4	I	Power supply input.
VOUT	B3, B4	O	Boost converter output.
EN	A1	I	<p>This is the enable pin of the device. On the rising edge of the enable pin, all the registers are reset with their default values. This input must not be left floating and must be terminated.</p> <p>EN = Low: The device is forced into shutdown mode and the I2C control interface is disabled. Depending on the logic level applied to the nBYP input, the converter can either be forced in pass-through mode or its output can be regulated to a minimum level so as to limit the input-to-output voltage difference to less than 3.6V (typ). The current consumption is reduced to a few μA. For more details, refer to Table 2.</p> <p>EN = High: The device is operating normally featuring automatic dc/dc boost, pass-through mode transition. For more details, refer to Table 2.</p>
GPIO	A2	I/O	<p>This pin can either be configured as a input (mode selection) or as dual role input/open-drain output ($\overline{\text{RST/FAULT}}$) pin. Per default, the pin is configured as $\overline{\text{RST/FAULT}}$ input/output. The input must not be left floating and must be terminated.</p> <p>Manual Reset Input: Drive $\overline{\text{RST/FAULT}}$ low to initiate a reset of the converter's output. nRST/nFAULT controls a falling edge-triggered sequence consisting of a discharge phase of the capacitance located at the converter's output followed by a start-up phase.</p> <p>Fault Output (open-drain interrupt signal to host): Indicates that a fault has occurred (e.g. thermal shutdown, output voltage out of limits, current limit triggered, and so on). To signal such an event, the device generates a falling edge-triggered interrupt by driving a negative pulse onto the GPIO line and then releases the line to its inactive state.</p> <p>Mode selection input = Low: The device is operating in regulated frequency pulse width modulation mode (PWM) at high-load currents and in pulse frequency modulation mode (PFM) at light load currents.</p> <p>Mode selection input = High: Low-noise mode enabled, regulated frequency PWM operation forced.</p>
VSEL	B1	I	VSEL signal is primarily used to set the output voltage dc/dc boost, pass-through threshold. This pin must not be left floating and must be terminated.
nBYP	C1	I	A logic low level on the $\overline{\text{BYP}}$ input forces the device in pass-through mode. For more details, refer to . This pin must not be left floating and must be terminated.
SCL	B2	I	Serial interface clock line. This pin must not be left floating and must be terminated.
SDA	C2	I/O	Serial interface address/data line. This pin must not be left floating and must be terminated.
SW	C3, C4	I/O	Inductor connection. Drain of the internal power MOSFET. Connect to the switched side of the inductor.
PGND	D2, D3, D4		Power ground pin.
AGND	D1		Analog ground pin. This is the signal ground reference for the IC.

**(TPS6128xA)
16-Bump DSBGA
YFF Package**

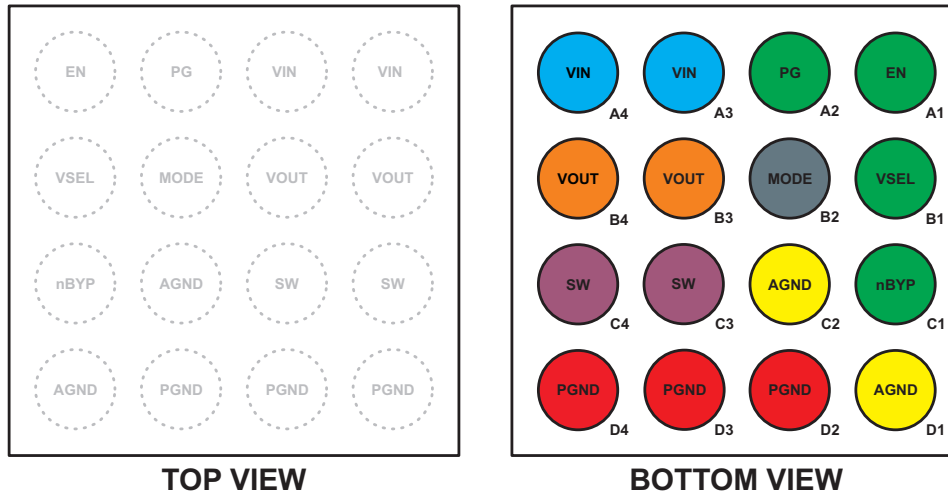

Pin Functions - TPS6128xA

PIN		I/O	DESCRIPTION
NAME	NO.		
VIN	A3, A4	I	Power supply input.
VOUT	B3, B4	O	Boost converter output.
EN	A1	I	<p>This is the enable pin of the device. On the rising edge of the enable pin, all the registers are reset with their default values. This input must not be left floating and must be terminated.</p> <p>EN = Low: The device is forced into shutdown mode. Depending on the logic level applied to the nBYP input, the converter can either be forced in pass-through mode or it's output can be regulated to a minimum level so as to limit the input-to-output voltage difference to less than 3.6V (typ). The current consumption is reduced to a few μA. For more details, refer to Table 2.</p> <p>EN = High: The device is operating normally featuring automatic dc/dc boost, pass-through mode transition. For more details, refer to Table 2.</p>
PG	A2	O	Power-Good Output (open-drain output to host): A logic high on the PG output indicates that the converter's output voltage is within its regulation limits. A logic low indicates a fault has occurred (e.g. thermal shutdown, output voltage out of limits, current limit triggered, and so on). The PG signal is de-asserted automatically once the IC resumes proper operation.
VSEL	B1	I	VSEL signal is primarily used to set the output voltage dc/dc boost, pass-through threshold. This pin must not be left floating and must be terminated.
nBYP	C1	I	A logic low level on the $\overline{\text{BYP}}$ input forces the device in pass-through mode. For more details, refer to Table 2 . This pin must not be left floating and must be terminated.
MODE	B2	I	<p>This is the mode selection pin of the device. This pin must not be left floating, must be terminated and can be connected to AGND. During start-up this pin must be held low. Once the output voltage settled and PG pin indicates that the converter's output voltage is within its regulation limits the device can be forced in PWM mode operation by applying a high level on this pin.</p> <p>MODE = Low: The device is operating in regulated frequency pulse width modulation mode (PWM) at high-load currents and in pulse frequency modulation mode (PFM) at light load currents. This pin must be held low during device start-up.</p> <p>MODE = High: Low-noise mode enabled, regulated frequency PWM operation forced.</p>
SW	C3, C4	I/O	Inductor connection. Drain of the internal power MOSFET. Connect to the switched side of the inductor.
PGND	D2, D3, D4		Power ground pin.
AGND	C2, D1		Analog ground pin. This is the signal ground reference for the IC.

9 Specifications

9.1 Absolute Maximum Ratings

 over operating free-air temperature range (unless otherwise noted)⁽¹⁾

			MIN	MAX	UNIT
Input voltage	Voltage at VOUT ⁽²⁾	DC	-0.3	4.7	V
	Voltage at VIN ⁽²⁾ , EN ⁽²⁾ , VSEL ⁽²⁾ , $\overline{\text{BYP}}$ ⁽²⁾ , PG ⁽²⁾ , GPIO ⁽²⁾	DC	-0.3	5.2	V
	Voltage at SCL ⁽²⁾ , SDA ⁽²⁾ MODE ⁽²⁾	DC	-0.3	3.6	V
	Voltage at SW ⁽²⁾	DC	-0.3	4.7	V
		Transient: 2 ns, 2.3 MHz		-0.3	5.5
Differential voltage between VIN and VOUT	DC	-0.3	4	V	
Input current	Continuous average current into SW ⁽³⁾			1.8	A
	Peak current into SW ⁽⁴⁾			5.5	A
Power dissipation			Internally limited		
Temperature range	Operating temperature range, T _A ⁽⁵⁾		-40	85	°C
	Operating virtual junction, T _J		-40	150	°C
T _{stg}	Storage temperature range		-65	150	°C

- (1) Stresses beyond those listed under *absolute maximum ratings* may cause permanent damage to the device. These are stress ratings only, and functional operation of the device at these or any other conditions beyond those indicated under *recommended operating conditions* is not implied. Exposure to absolute-maximum-rated conditions for extended periods may affect device reliability.
- (2) All voltages are with respect to network ground terminal.
- (3) Limit the junction temperature to 105°C for continuous operation at maximum output power.
- (4) Limit the junction temperature to 105°C for 15% duty cycle operation.
- (5) In applications where high power dissipation and/or poor package thermal resistance is present, the maximum ambient temperature may have to be derated. Maximum ambient temperature (T_{A(max)}) is dependent on the maximum operating junction temperature (T_{J(max)}), the maximum power dissipation of the device in the application (P_{D(max)}), and the junction-to-ambient thermal resistance of the part/package in the application (θ_{JA}), as given by the following equation: T_{A(max)} = T_{J(max)} - (θ_{JA} X P_{D(max)}). To achieve optimum performance, it is recommended to operate the device with a maximum junction temperature of 105°C.

9.2 ESD Ratings

			VALUE	UNIT
V _{ESD}	Electrostatic discharge	Human body model (HBM), per ANSI/ESDA/JEDEC JS-001, all pins ⁽¹⁾	±2000	V
		Charged device model (CDM), per JEDEC specification JESD22-C101, all pins ⁽²⁾	±1000	V
		Machine Model - (MM)	±200	V

- (1) JEDEC document JEP155 states that 500-V HBM allows safe manufacturing with a standard ESD control process.
- (2) JEDEC document JEP157 states that 250-V CDM allows safe manufacturing with a standard ESD control process.

9.3 Recommended Operating Conditions

		MIN	NOM	MAX	UNIT
V _I	Input voltage range	2.30		4.85	V
	Input voltage range for in-situ customization by E ² PROM write operation	3.4	3.5	3.6	V
L	Inductance	200	470	800	nH
C _O	Output capacitance	9	13	100	μF
I _L	Maximum load current during start-up	250			mA
T _A	Ambient temperature	-40		85	°C
T _J	Operating junction temperature	-40		125	°C

9.4 Thermal Information

THERMAL METRIC ⁽¹⁾		TPS6128xA	UNIT
		YFF PACKAGE (DSBGA)	
		16 PINS	
R _{θJA}	Junction-to-ambient thermal resistance	78	°C/W
R _{θJctop}	Junction-to-case (top) thermal resistance	0.6	°C/W
R _{θJB}	Junction-to-board thermal resistance	13	°C/W
Ψ _{JT}	Junction-to-top characterization parameter	2.4	°C/W
Ψ _{JB}	Junction-to-board characterization parameter	13	°C/W
R _{θJcbot}	Junction-to-case (bottom) thermal resistance	n/a	°C/W

(1) For more information about traditional and new thermal metrics, see the *Semiconductor and IC Package Thermal Metrics* application report (SPRA953).

9.5 Electrical Characteristics

Minimum and maximum values are at V_{IN} = 2.3V to 4.85V, V_{OUT} = 3.4V (or V_{IN}, whichever is higher), EN = 1.8V, VSEL = 1.8V, nBYP = 1.8V, –40°C ≤ T_J ≤ 125°C; Circuit of Parameter Measurement Information section (unless otherwise noted). Typical values are at V_{IN} = 3.2V, V_{OUT} = 3.4V, EN = 1.8V, T_J = 25°C (unless otherwise noted).

PARAMETER		TEST CONDITIONS		MIN	TYP	MAX	UNIT
SUPPLY CURRENT							
I _Q	Operating quiescent current into V _{IN}	TPS6128xA	DC/DC boost mode. Device not switching I _{OUT} = 0mA, V _{IN} = 3.2V, V _{OUT} = 3.4V	–40°C ≤ T _J ≤ 85°C	47.4	65.6	μA
			Pass-through mode (auto) EN = 1.8V, $\overline{\text{BYP}}$ = 1.8V, V _{IN} = 3.6V		27.4	42.6	μA
			Pass-through mode (forced) EN = 1.8V, $\overline{\text{BYP}}$ = AGND, V _{OUT} = 3.6V		15.4	25.6	μA
	Operating quiescent current into V _{OUT}	8.9	19.6		μA		
I _{SD}	Shutdown current	TPS6128xA	EN = 0V, $\overline{\text{BYP}}$ = 0V, V _{IN} = 3.6V	3.0	6.6	μA	
			EN = 0V, $\overline{\text{BYP}}$ = 1.8V, V _{IN} = 3.6V	8.9	20.6	μA	
V _{UVLO}	Under-voltage lockout threshold	TPS6128xA	Falling	2.0	2.1	V	
			Hysteresis	0.1		V	
EN, VSEL, nBYP, MODE, SDA, SCL, GPIO, PG							
V _{IL}	Low-level input voltage	TPS6128xA				0.4	V
V _{IH}	High-level input voltage		1.2		V		
V _{OL}	Low-level output voltage (SDA)	TPS61280A	I _{OL} = 8mA			0.3	V
	Low-level output voltage (GPIO)		I _{OL} = 8mA, GPIOCFG = 0			0.3	V
	Low-level output voltage (PG)	TPS6128xA	I _{OL} = 8mA			0.3	V
R _{PD}	EN, VSEL, $\overline{\text{BYP}}$, pull-down resistance	TPS6128xA	Input ≤ 0.4 V		300		kΩ
C _{IN}	EN, VSEL, $\overline{\text{BYP}}$, MODE, PG input capacitance	TPS6128xA	Input connected to AGND or V _{IN}		9		pF
	SDA, SCL, GPIO input capacitance	TPS61280A		9		pF	
V _{THPG}	Power good threshold	TPS6128xA	Rising V _{OUT}		0.95 x		
			Falling V _{OUT}		0.9 x		
I _{lkg}	Input leakage current	TPS6128xA	Input connected to AGND	–40°C ≤ T _J ≤ 85°C	0		μA
			Input connected V _{IN}			0.5	μA
OUTPUT							
V _{OUT(TH)}	Threshold DC voltage accuracy	TPS6128xA	No load. Open loop		–1.5	+1.5	%

Electrical Characteristics (continued)

Minimum and maximum values are at $V_{IN} = 2.3V$ to $4.85V$, $V_{OUT} = 3.4V$ (or V_{IN} , whichever is higher), $EN = 1.8V$, $VSEL = 1.8V$, $nBYP = 1.8V$, $-40^{\circ}C \leq T_J \leq 125^{\circ}C$; Circuit of Parameter Measurement Information section (unless otherwise noted). Typical values are at $V_{IN} = 3.2V$, $V_{OUT} = 3.4V$, $EN = 1.8V$, $T_J = 25^{\circ}C$ (unless otherwise noted).

PARAMETER			TEST CONDITIONS	MIN	TYP	MAX	UNIT	
V_{OUT}	Regulated DC voltage accuracy	TPS6128xA	$2.65V \leq V_{IN} \leq V_{OUT_TH} - 150mV$ $I_{OUT} = 0mA$ PWM operation.	-2.0		+2.0	%	
			$2.65V \leq V_{IN} \leq V_{OUT_TH} - 150mV$ $I_{OUT} = 0mA$ PFM/PWM operation	-2.0		+4.0	%	
ΔV_{OUT}	Power-save mode output ripple voltage	TPS6128xA	PFM operation, $I_{OUT} = 1mA$		30		mVpk	
	PWM mode output ripple voltage		PWM operation, $I_{OUT} = 500mA$		15		mVpk	
POWER SWITCH								
$r_{DS(on)}$	Low-side switch MOSFET on resistance	TPS6128xA	$V_{IN} = 3.2, V_{OUT} = 3.5V$		45	80	m Ω	
	High-side rectifier MOSFET on resistance		$V_{IN} = 3.2V, V_{OUT} = 3.5V$		40	70	m Ω	
	High-side pass-through MOSFET on resistance		$V_{IN} = 3.2V$		35	60	m Ω	
I_{lkg}	Reverse leakage current into SW	TPS6128xA	$EN = \overline{AGND}, V_{IN} = V_{OUT} = SW = 3.5V$ $-40^{\circ}C \leq T_J \leq 85^{\circ}C$		0.1	2	μA	
	Reverse leakage current into VOUT		$EN = \overline{BYP} = VIN, V_{IN} = 2.9V, V_{OUT} = 4.4V, V_{SW} = 0V$ device not switching $-40^{\circ}C \leq T_J \leq 85^{\circ}C$		0.11	2	μA	
I_{SINK}	VOUT sink capability	TPS6128xA	$EN = \overline{AGND}, V_{OUT} \leq 3.6V, I_{OUT} = -10mA$			0.3	V	
	Valley inductor current limit	TPS61280A TPS61281A	$V_{IN} = 2.9V, V_{OUT} = 3.5V, -40^{\circ}C \leq T_J \leq 125^{\circ}C$, auto PFM/PWM	2475	3000	3525	mA	
	Valley inductor current limit	TPS61282A	$V_{IN} = 2.9V, V_{OUT} = 3.5V, -40^{\circ}C \leq T_J \leq 125^{\circ}C$, auto PFM/PWM	3300	4000	4700	mA	
	Pass through mode current limit	TPS6128xA	$EN = \overline{BYP} = GND, V_{IN} = 3.2V$		5000		mA	
			$EN = V_{IN}, \overline{BYP} = \text{don't care}, V_{IN} = 3.2V$	5600	7400	9100	mA	
	Pre-charge mode current limit (linear mode, phase 1)	TPS6128xA	$V_{IN} - V_{OUT} \geq 300mV$		500	650		mA
	Pre-charge mode current limit (linear mode, phase 2)					2000		mA
OSCILLATOR								
f_{OSC}	Oscillator frequency	TPS6128xA	$V_{IN} = 2.7V, V_{OUT} = 3.5$		2.3		MHz	
THERMAL SHUTDOWN, HOT DIE DETECTOR								
	Thermal shutdown ⁽¹⁾	TPS6128xA		140	160		$^{\circ}C$	
	Hot die detector accuracy ⁽¹⁾	TPS61280A		-10	105	+10	$^{\circ}C$	
TIMING								
	Start-up time	TPS6128xA	$V_{IN} = 3.2V, V_{OUT_TH} = 01011 (3.4V), R_{LOAD} = 50\Omega$ Time from active V_{IN} to V_{OUT} settled		500		μs	
	GPIO rise time ⁽¹⁾	TPS61280A				200	ns	

(1) Specified by characterization. Not tested in production.

9.6 I²C Interface Timing Characteristics⁽¹⁾

PARAMETER		TEST CONDITIONS	MIN	MAX	UNIT
f _(SCL)	SCL Clock Frequency	Standard mode		100	kHz
		Fast mode		400	kHz
		Fast mode plus		1	MHz
		High-speed mode (write operation), C _B – 100 pF max		3.4	MHz
		High-speed mode (read operation), C _B – 100 pF max		3.4	MHz
		High-speed mode (write operation), C _B – 400 pF max		1.7	MHz
		High-speed mode (read operation), C _B – 400 pF max		1.7	MHz
t _{BUF}	Bus Free Time Between a STOP and START Condition	Standard mode	4.7		μs
		Fast mode	1.3		μs
		Fast mode plus	0.5		μs
t _{HD} , t _{STA}	Hold Time (Repeated) START Condition	Standard mode	4		μs
		Fast mode	600		ns
		Fast mode plus	260		ns
		High-speed mode	160		ns
t _{LOW}	LOW Period of the SCL Clock	Standard mode	4.7		μs
		Fast mode	1.3		μs
		Fast mode plus	0.5		μs
		High-speed mode, C _B – 100 pF max	160		ns
		High-speed mode, C _B – 400 pF max	320		ns
t _{HIGH}	HIGH Period of the SCL Clock	Standard mode	4		μs
		Fast mode	600		ns
		Fast mode plus	260		ns
		High-speed mode, C _B – 100 pF max	60		ns
		High-speed mode, C _B – 400 pF max	120		ns
t _{SU} , t _{STA}	Setup Time for a Repeated START Condition	Standard mode	4.7		μs
		Fast mode	600		ns
		Fast mode plus	260		ns
		High-speed mode	160		ns
t _{SU} , t _{DAT}	Data Setup Time	Standard mode	250		ns
		Fast mode	100		ns
		Fast mode plus	50		ns
		High-speed mode	10		ns
t _{HD} , t _{DAT}	Data Hold Time	Standard mode	0	3.45	μs
		Fast mode	0	0.9	μs
		Fast mode plus	0		μs
		High-speed mode, C _B – 100 pF max	0	70	ns
		High-speed mode, C _B – 400 pF max	0	150	ns
t _{RCL}	Rise Time of SCL Signal	Standard mode		1000	ns
		Fast mode	20 + 0.1 C _B	300	ns
		Fast mode plus		120	ns
		High-speed mode, C _B – 100 pF max	10	40	ns
		High-speed mode, C _B – 400 pF max	20	80	ns
t _{RCL1}	Rise Time of SCL Signal After a Repeated START Condition and After an Acknowledge BIT	Standard mode	20 + 0.1 C _B	1000	ns
		Fast mode	20 + 0.1 C _B	300	ns
		Fast mode plus		120	ns
		High-speed mode, C _B – 100 pF max	10	80	ns
		High-speed mode, C _B – 400 pF max	20	160	ns

(1) Specified by design. Not tested in production.

I²C Interface Timing Characteristics⁽¹⁾ (continued)

PARAMETER		TEST CONDITIONS	MIN	MAX	UNIT
t _{FCL}	Fall Time of SCL Signal	Standard mode	20 + 0.1 C _B	300	ns
		Fast mode		300	ns
		Fast mode plus		120	ns
		High-speed mode, C _B – 100 pF max	10	40	ns
		High-speed mode, C _B – 400 pF max	20	80	ns
t _{RDA}	Rise Time of SDA Signal	Standard mode		1000	ns
		Fast mode	20 + 0.1 C _B	300	ns
		Fast mode plus		120	ns
		High-speed mode, C _B – 100 pF max	10	80	ns
		High-speed mode, C _B – 400 pF max	20	160	ns
t _{FDA}	Fall Time of SDA Signal	Standard mode		300	ns
		Fast mode	20 + 0.1 C _B	300	ns
		Fast mode plus		120	ns
		High-speed mode, C _B – 100 pF max	10	80	ns
		High-speed mode, C _B – 400 pF max	20	160	ns
t _{SU} , t _{STO}	Setup Time of STOP Condition	Standard mode	4		μs
		Fast mode	600		ns
		Fast mode plus	260		ns
		High-Speed mode	160		ns
C _B	Capacitive Load for SDA and SCL	Standard mode		400	pF
		Fast mode		400	pF
		Fast mode plus		550	pF
		High-Speed mode		400	pF

9.7 I²C Timing Diagrams

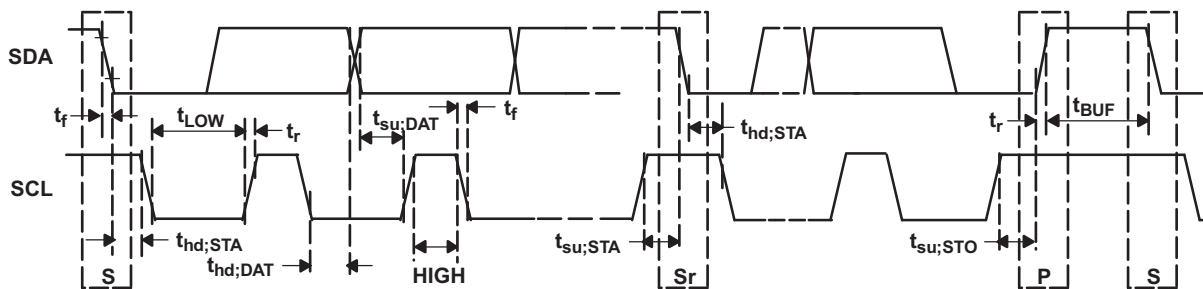
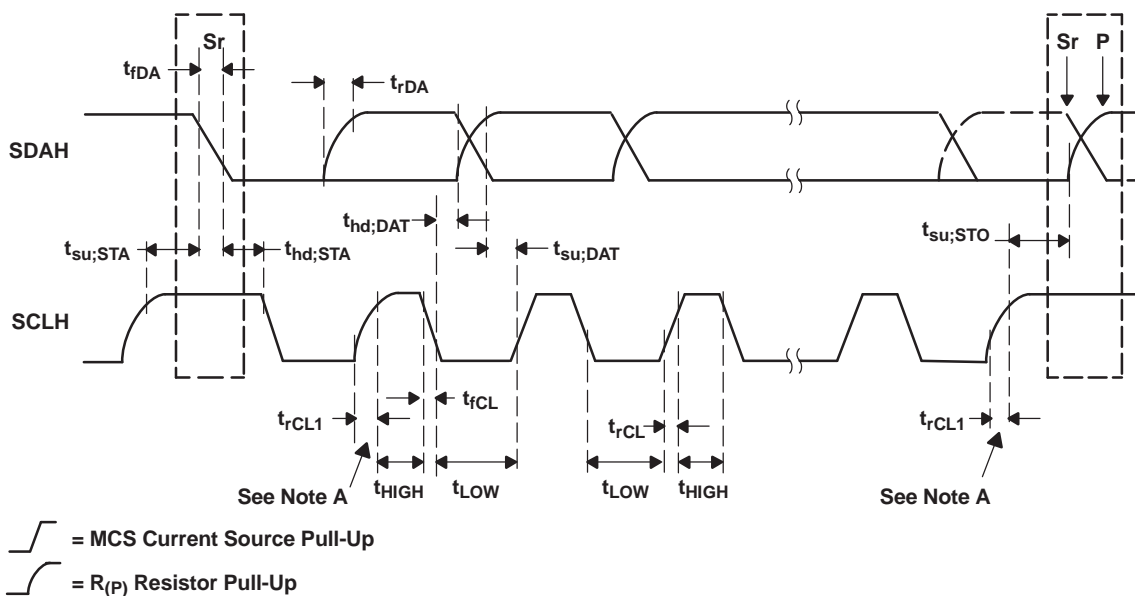

Figure 1. Serial Interface Timing Diagram for Standard-, Fast-, Fast-Mode Plus



Note A: First rising edge of the SCLH signal after Sr and after each acknowledge bit.

Figure 2. Serial Interface Timing Diagram for H/S-Mode

9.8 Typical Characteristics

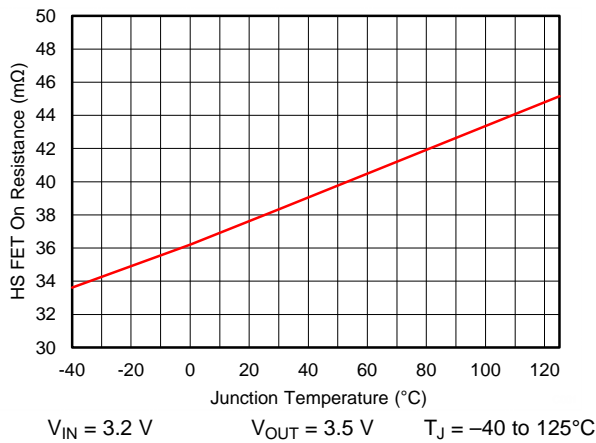

Figure 3. High side $R_{ds(on)}$ vs Junction Temperature

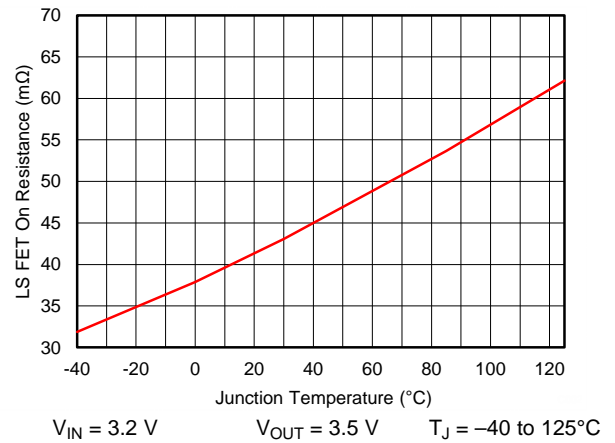

Figure 4. Low side $R_{ds(on)}$ vs Junction Temperature

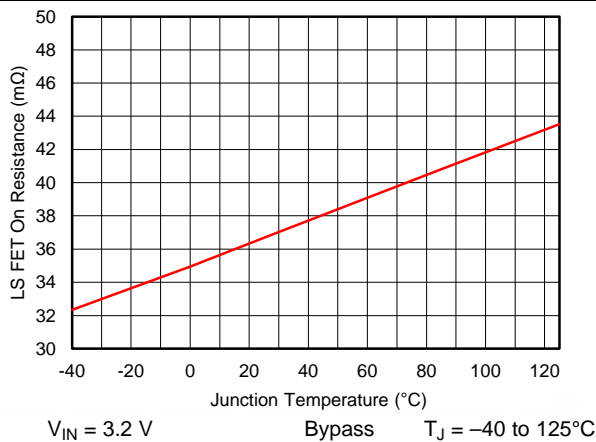

Figure 5. Bypass FET $R_{ds(on)}$ vs Junction Temperature

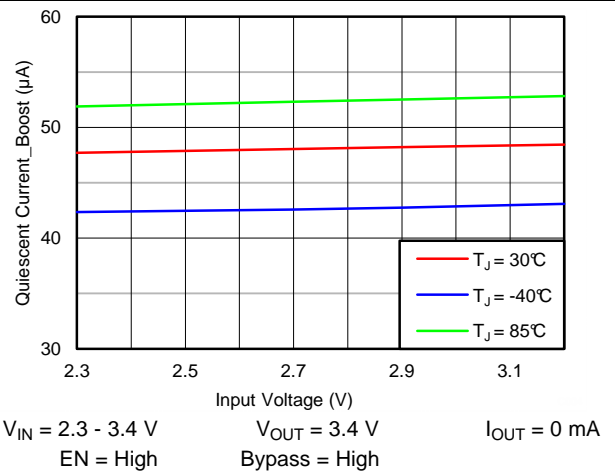

Figure 6. Quiescent Current at Boost Mode vs Input Voltage

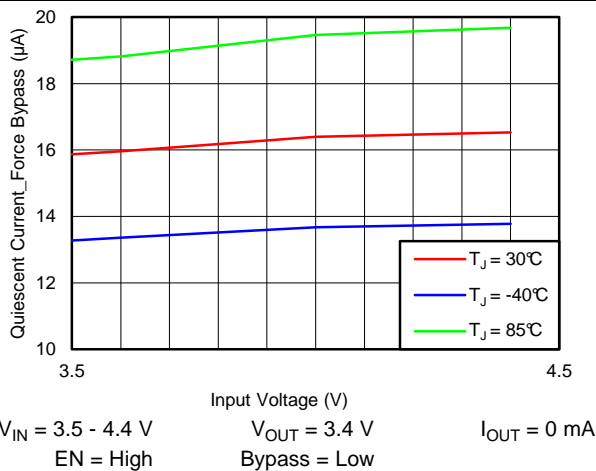

Figure 7. Quiescent Current at Forced Bypass Mode vs Input Voltage

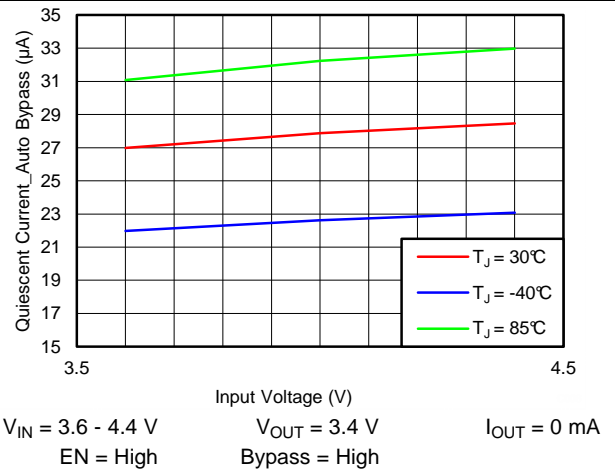

Figure 8. Quiescent Current at Auto Bypass Mode vs Input Voltage

Typical Characteristics (continued)

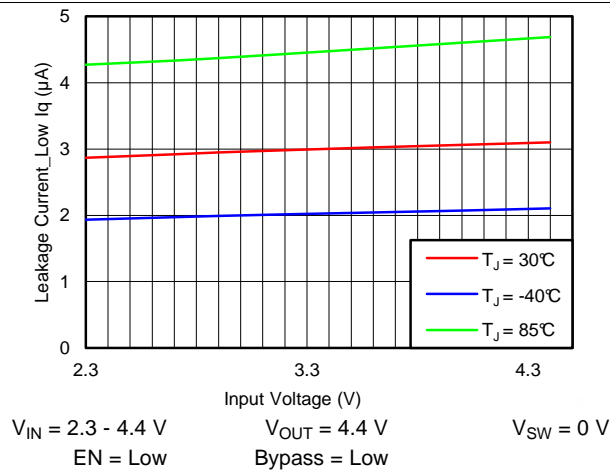

Figure 9. Shutdown Current at Low I_Q mode vs Input Voltage

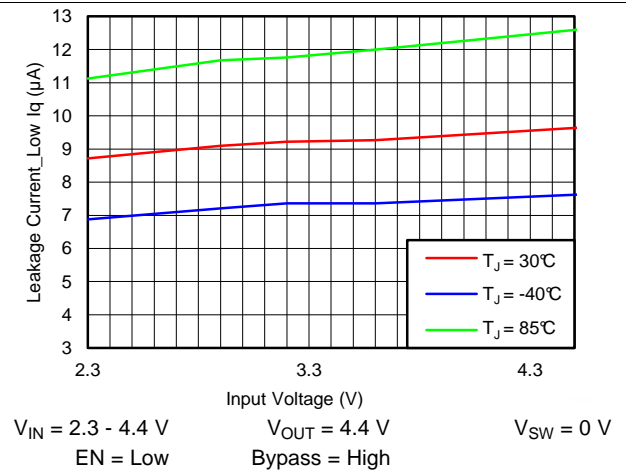

Figure 10. Shutdown Current vs Input Voltage

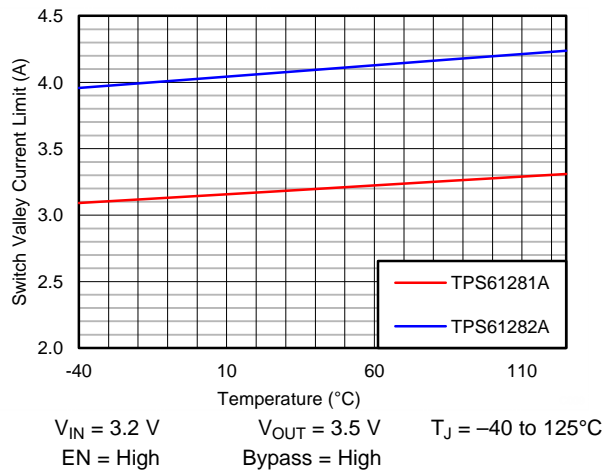

Figure 11. Switch Valley Current Limit: TPS61281A, TPS61282A vs Input Voltage

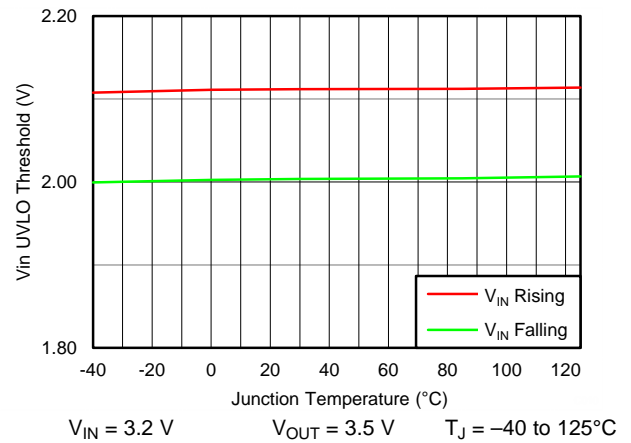

Figure 12. V_{IN} UVLO Threshold Rising/Falling vs Junction Temperature

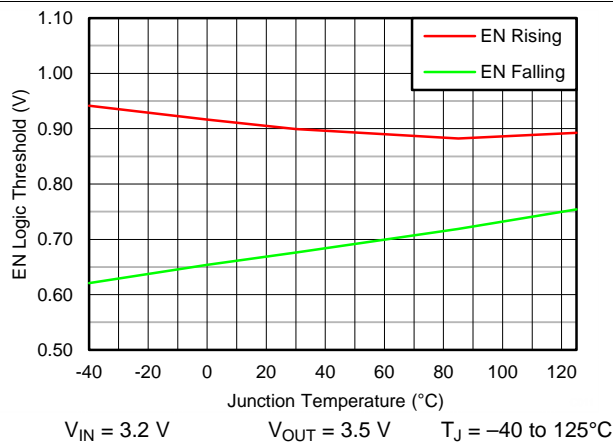

Figure 13. EN Logic High Threshold Rising/Falling vs Junction Temperature

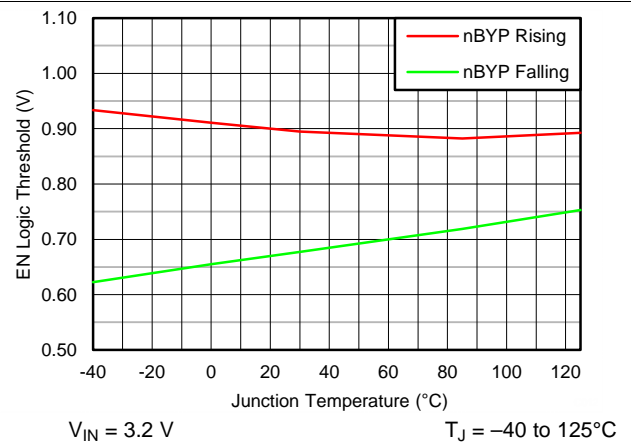

Figure 14. $\overline{\text{BYP}}$ Logic High Threshold Rising/Falling vs Junction Temperature

10 Detailed Description

10.1 Overview

The TPS6128xA is a high-efficiency step-up converter featuring pass-through mode optimized to provide low-noise voltage supply for 2G RF power amplifiers (PAs) in mobile phones and/or to pre-regulate voltage for supplying subsystem like eMMC memory, audio codec, LCD bias, antenna switches, RF engine PMIC and so on. It is designed to allow the system to operate at maximum efficiency for a wide range of power consumption levels from a low-, wide- voltage battery cell.

The capability of the TPS6128xA to step-up the voltage as well as to pass-through the input battery voltage when its level is high enough allow systems to operate at maximum performance over a wide range of battery voltages, thereby extending the battery life between charging. The device also addresses brownouts caused by the peak currents drawn by the APU and GPU which can cause the battery rail to droop momentarily. Using the TPS6128xA device as a pre-regulator eliminates system brownout condition while maintaining a stable supply rail for critical sub-system to function properly.

The TPS6128xA synchronous step-up converter typically operates at a quasi-constant 2.3-MHz frequency pulse width modulation (PWM) at moderate to heavy load currents. At light load currents, the TPS6128xA converter operates in power-save mode with pulse frequency modulation (PFM).

In general, a dc/dc step-up converter can only operate in "true" boost mode, that is the output "boosted" by a certain amount above the input voltage. The TPS6128xA device operates differently as it can smoothly transition in and out of zero duty cycle operation. Depending upon the input voltage, output voltage threshold and load current, the integrated bypass switch automatically transitions the converter into pass-through mode to maintain low-dropout and high-efficiency. The device exits pass-through mode (0% duty cycle operation) if the total dropout resistance in bypass mode is insufficient to maintain the output voltage at it's nominal level. Refer to the typical characteristics section (DC Output Voltage vs. Input Voltage) for further details.

During PWM operation, the converter uses a novel quasi-constant on-time valley current mode control scheme to achieve excellent line/load regulation and allows the use of a small ceramic inductor and capacitors. Based on the V_{IN}/V_{OUT} ratio, a simple circuit predicts the required on-time. At the beginning of the switching cycle, the low-side N-MOS switch is turned-on and the inductor current ramps up to a peak current that is defined by the on-time and the inductance. In the second phase, once the on-timer has expired, the rectifier is turned-on and the inductor current decays to a preset valley current threshold. Finally, the switching cycle repeats by setting the on timer again and activating the low-side N-MOS switch.

The current mode architecture provides excellent transient load response, requiring minimal output filtering. Internal soft-start and loop compensation simplifies the design process while minimizing the number of external components.

The TPS6128xA directly and accurately controls the average input current through intelligent adjustment of the valley current limit, allowing an accuracy of $\pm 17.5\%$. Together with an external bulk capacitor, the TPS6128xA allows an application to be interfaced directly to its load, without overloading the input source due to appropriate set average input current limit. An open-drain output (PG or GPIO/nFAULT) provides a signal to issue an interrupt to the system if any fault is detected on the device (thermal shutdown, output voltage out-of limits, and so on).

The output voltage can be dynamically adjusted between two values (floor and roof voltages) by toggling a logic control input (VSEL) without the need for external feedback resistors. This features can either be used to raise the output voltage in anticipation of a positive load transient or to dynamically change the PA supply voltage depending on its mode of operation and/or transmitting power.

The TPS61280A integrates an I²C compatible interface allowing transfers up to 3.4Mbps. This communication interface can be used to set the output voltage threshold at which the converter transitions between boost and pass-through mode, for reprogramming the mode of operation (PFM/PWM or forced PWM), for settings the average input current limit or resetting the output voltage for instance.

Configuration parameters can be changed by writing the desired values to the appropriate I²C register(s). The I²C registers are volatile and their contents are lost when power is removed from the device. By writing to the [E2PROMCTRL Register](#), it is possible to store the active configuration in non-volatile E²PROM; during power-up, the contents of the E²PROM are copied into the I²C registers and used to configure the device.

10.2 Functional Block Diagram

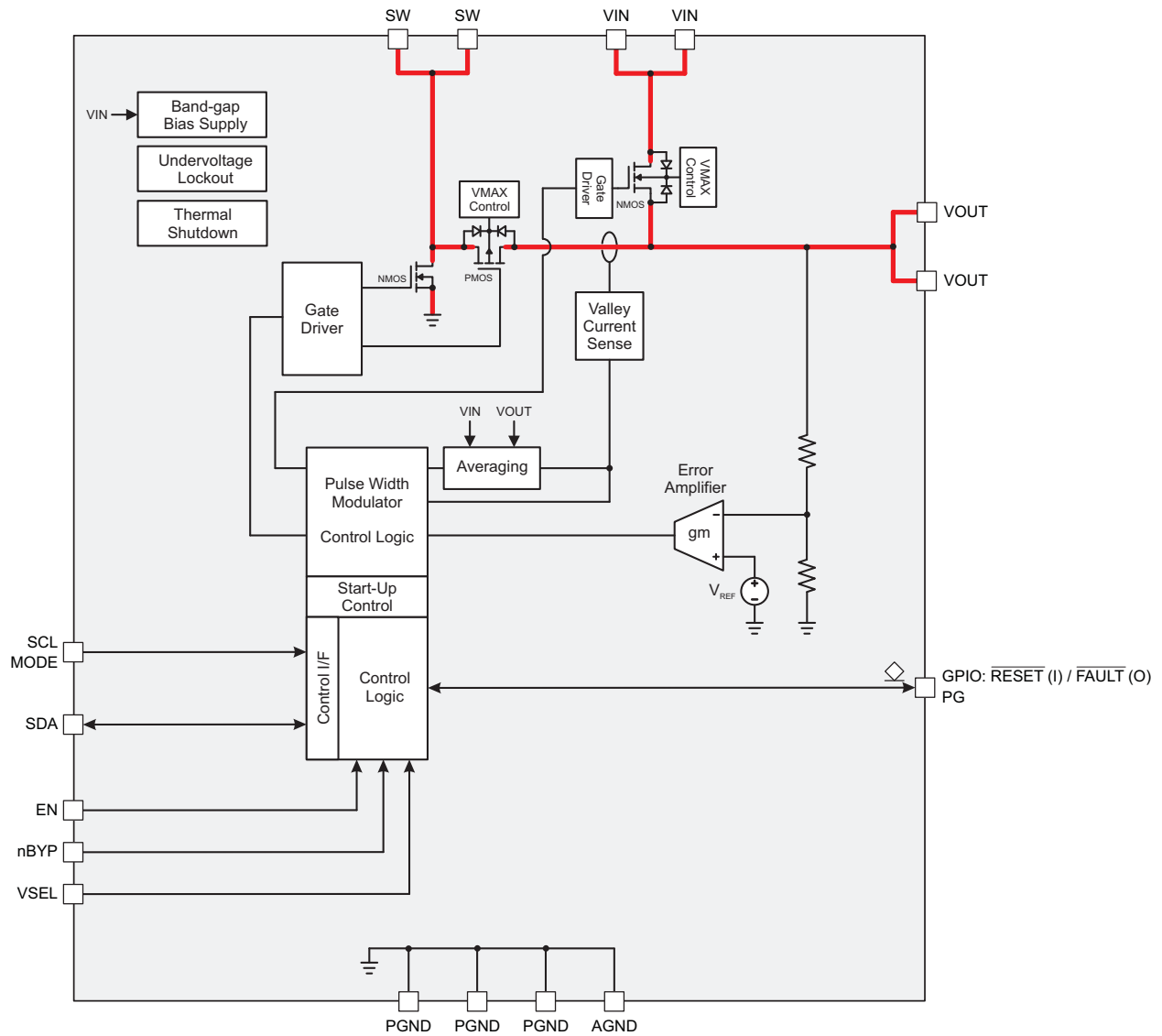

10.3 Feature Description

10.3.1 Voltage Scaling Management (VSEL)

In order to maintain a certain minimum output voltage under heavy load transients, the output voltage set point can be dynamically increased by asserting the VSEL input. The functionality also helps to mitigate undershoot during severe line transients, while minimizing the output voltage during more benign operating conditions to save power.

The output voltage ramps up (floor to roof transition) at pre-defined rate defined by the average input current limit setting. The required time to ramp down the voltage (roof to floor transition) largely depends on the amount of capacitance present at the converter's output as well as on the load current. Table 1 shows the ramp rate control when transitioning to a lower voltage.

Table 1. Ramp Down Rate vs. Target Mode

Mode Associated with Floor Voltage	Output Voltage Ramp Rate
Forced PWM	Output capacitance is being discharged at a rate of approx. 50mA (or higher) constant current in addition to the load current drawn
PFM	Output capacitance is being discharged (solely) by the load current drawn

10.3.2 Spread Spectrum, PWM Frequency Dithering

The goal is to spread out the emitted RF energy over a larger frequency range so that the resulting EMI is similar to white noise. The end result is a spectrum that is continuous and lower in peak amplitude, making it easier to comply with electromagnetic interference (EMI) standards and with the power supply ripple requirements in cellular and non-cellular wireless applications. Radio receivers are typically susceptible to narrowband noise that is focused on specific frequencies.

Switching regulators can be particularly troublesome in applications where electromagnetic interference (EMI) is a concern. Switching regulators operate on a cycle-by-cycle basis to transfer power to an output. In most cases, the frequency of operation is either fixed or regulated, based on the output load. This method of conversion creates large components of noise at the frequency of operation (fundamental) and multiples of the operating frequency (harmonics).

The spread spectrum architecture varies the switching frequency by ca. ±15% of the nominal switching frequency thereby significantly reducing the peak radiated and conducting noise on both the input and output supplies. The frequency dithering scheme is modulated with a triangle profile and a modulation frequency f_m .

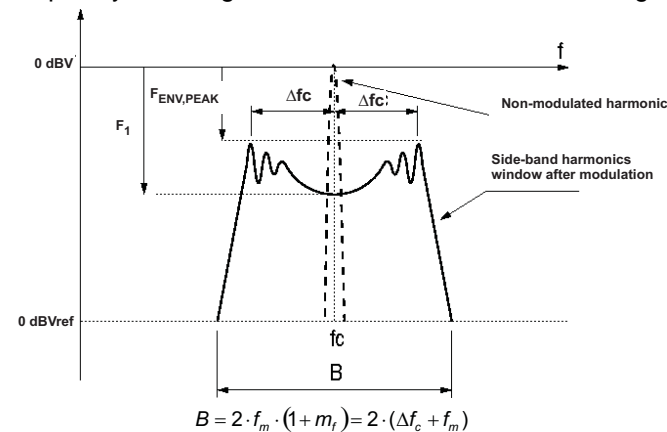

Figure 15. Spectrum of a Frequency Modulated Sin. Wave with Sinusoidal Variation in Time

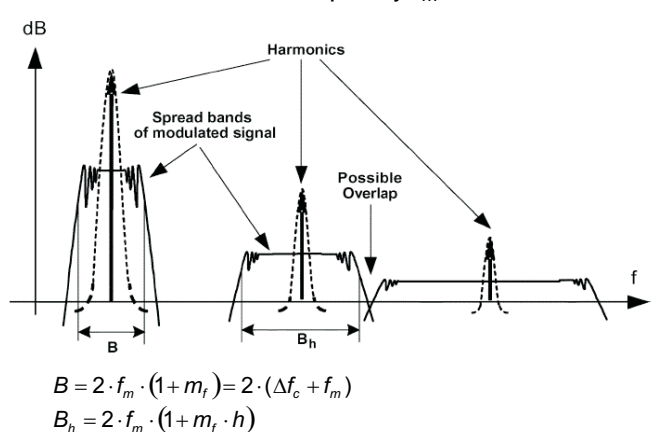

Figure 16. Spread Bands of Harmonics in Modulated Square Signals ⁽¹⁾

The above figures show that after modulation the sideband harmonic is attenuated compared to the non-modulated harmonic, and the harmonic energy is spread into a certain frequency band. The higher the modulation index (mf) the larger the attenuation.

(1) Spectrum illustrations and formulae (Figure 15 and Figure 16) copyright IEEE TRANSACTIONS ON ELECTROMAGNETIC COMPATIBILITY, VOL. 47, NO.3, AUGUST 2005.

$$m_f = \frac{\delta \times f_c}{f_m}$$

where

- f_c is the carrier frequency (approx. 2.3MHz)
 - f_m is the modulating frequency (approx. 40kHz)
 - δ is the modulation ratio (approx 0.15)
- (1)

$$\delta = \frac{\Delta f_c}{f_c}$$

(2)

The maximum switching frequency f_c is limited by the process and finally the parameter modulation ratio (δ), together with f_m , which is the side-band harmonics bandwidth around the carrier frequency f_c . The bandwidth of a frequency modulated waveform is approximately given by the Carson's rule and can be summarized as:

$$B = 2 \times f_m \times (1 + m_f) = 2 \times (\Delta f_c + f_m)$$

(3)

$f_m < RBW$: The receiver is not able to distinguish individual side-band harmonics, so, several harmonics are added in the input filter and the measured value is higher than expected in theoretical calculations.

$f_m > RBW$: The receiver is able to properly measure each individual side-band harmonic separately, so the measurements match with the theoretical calculations.

10.4 Device Functional Modes

10.4.1 Power-Save Mode

The TPS6128xA integrates a power-save mode to improve efficiency at light load. In power save mode the converter only operates when the output voltage trips below a set threshold voltage. It ramps up the output voltage with several pulses and goes into power save mode once the output voltage exceeds the set threshold voltage. The PFM mode is left and PWM mode entered in case the output current can not longer be supported in PFM mode.

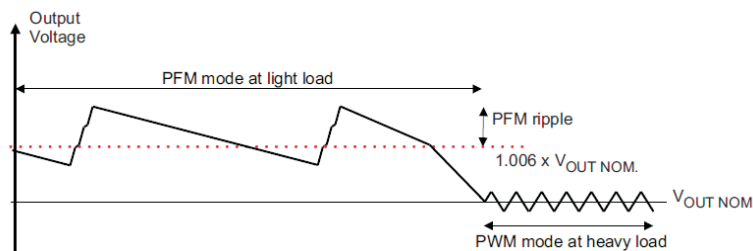

Figure 17. Power-Save Mode Ripple

10.4.2 Pass-Through Mode

The TPS6128xA contains an internal switch for bypassing the dc/dc boost converter during pass-through mode. When the input voltage is larger than the preset output voltage, the converter seamlessly transitions into 0% duty cycle operation and the bypass FET is fully enhanced. Entry in pass-through mode is triggered by condition where $V_{OUT} > (1+2\%) \times V_{OUT_NORM}$ and no switching has occurred during past 8 μ s.

In this mode of operation, the load (2G RF PA for instance) is directly supplied from the battery for maximum RF output power, highest efficiency and lowest possible input-to-output voltage difference. The device consumes only a standby current of 15 μ A (typ). In pass-through mode, the device is short-circuit protected by a very fast current limit detection scheme.

During this operation, the output voltage follows the input voltage and will not fall below the programmed output voltage threshold as the input voltage decreases. The output voltage drop during pass-through mode depends on the load current and input voltage, the resulting output voltage is calculated as:

Device Functional Modes (continued)

$$V_{OUT} = V_{IN} - (R_{DS(ON)(BP)} \times I_{OUT}) \tag{4}$$

Conversely, the efficiency in pass-through mode is defined as:

$$\eta = 1 - R_{DS(ON)(BP)} \frac{I_{OUT}}{V_{IN}} \tag{5}$$

- in which $R_{DS(ON)(BP)}$ is the typical on-resistance of the bypass FET

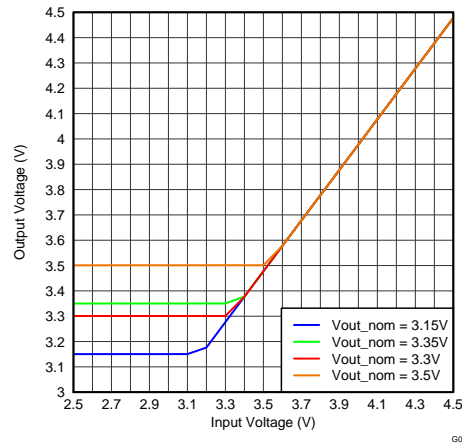

Figure 18. DC Output Voltage vs. Input Voltage

Pass-through mode exit is triggered when the output voltage reaches the pre-defined threshold (that is, 3.4V).

During pass-through mode, the TPS6128xA device is short-circuit protected by a fast current limit detection scheme. If the current in the pass-through FET exceeds approximately 7.3 Amps a fault is declared and the device cycles through a start-up procedure.

10.4.3 Mode Selection

Depending on the settings of [CONFIG Register](#) the device can be operated at a quasi-constant 2.3-MHz frequency PWM mode or in automatic PFM/PWM mode. In this mode, the converter operates in pseudo-fixed frequency PWM mode at moderate to heavy loads and in the PFM mode during light loads, which maintains high efficiency over a wide load current range. For more details, see the [CONFIG Register](#) description.

The quasi-constant frequency PWM mode has the tightest regulation and the best line/load transient performance. In forced PWM mode, the device features a unique $R_{DS(ON)}$ management function to maintain high broadband efficiency as well as low resistance in pass-through mode.

In the TPS61280A device, the GPIO pin can be configured (via the [CONFIG Register](#)) to select the operating mode of the device. In the other TPS6128xA devices, the MODE pin is used to select the operating mode. Pulling this pin high forces the converter to operate in the PWM mode even at light load currents. The advantage is that the converter modulates its switching frequency according to a spread spectrum PWM modulation technique allowing simple filtering of the switching harmonics in noise-sensitive applications.

For additional flexibility, it is possible to switch from power-save mode (GPIO or MODE input = L) to PWM mode (GPIO or MODE input = H) during operation. This allows efficient power management by adjusting the operation of the converter to the specific system requirements (that is, 2G RF PA Rx/Tx operation).

Entry to forced pass-through mode (nBYP = L) initiates with a current limited transition followed by a true bypass state. To prevent reverse current to the battery, the devices waits until the output discharges below the input voltage level before entering forced pass-through mode. Care should be taken to prohibit the output voltage from collapsing whilst transitioning into forced pass-through mode under heavy load conditions and/or limited output capacitance. This can be easily done by adding capacitance to the output of the converter. In forced pass-through mode, the output follows the input below the preset output threshold voltage (VOUT_TH).

Device Functional Modes (continued)

10.4.4 Current Limit Operation

The TPS6128xA device features a valley inductor current limit scheme.

In dc/dc boost mode, the TPS6128xA device employs a current limit detection scheme in which the voltage drop across the synchronous rectifier is sensed during the off-time. In the TPS61280A the current limit threshold can be set via an I²C register. TPS6128xA devices have a fixed current limit threshold. See device ordering table for detailed information.

The output voltage is reduced as the power stage of the device operates in a constant current mode. The maximum continuous output current (I_{OUT(MAX)}), before entering current limit (CL) operation, can be defined by Equation 6.

$$I_{OUT(MAX_DC)} = I_{LIMIT} \times \frac{V_{IN}}{V_{OUT}} \times \eta$$

where

- η is the efficiency
- The inductor peak-to-peak current ripple (ΔI_L) is calculated by Equation 7

$$\Delta I_L = \frac{V_{IN}}{L} \times \frac{D}{f} \tag{7}$$

The output current, I_{OUT(DC)}, is the average of the rectifier ripple current waveform. When the load current is increased such that the trough is above the current limit threshold, the off-time is increased to allow the current to decrease to this threshold before the next on-time begins (so called frequency fold-back mechanism). When the current limit is reached the output voltage decreases during further load increase.

Figure 19 illustrates the inductor and rectifier current waveforms during current limit operation.

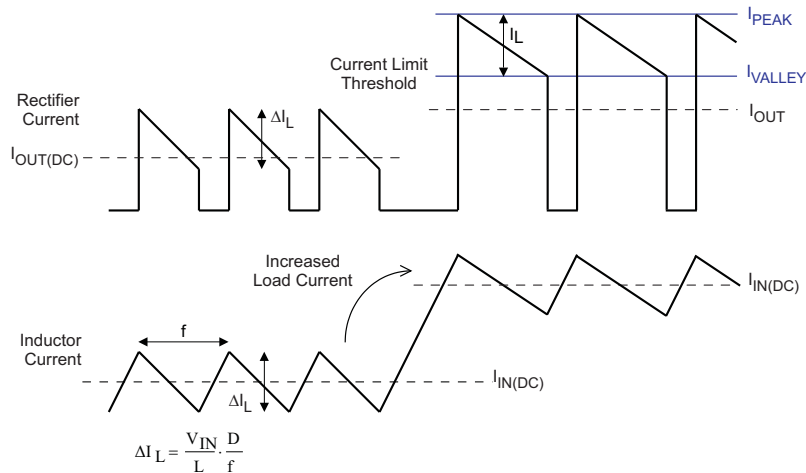

Figure 19. Inductor/Rectifier Currents in Current Limit Operation (DC/DC Boost Mode)

During pass-through mode, the TPS6128xA device is short-circuit protected by a very fast current limit detection scheme. If the current in the bypass FET exceeds approximately 7.5Amps a fault is declared and the device cycles through a start-up procedure.

Device Functional Modes (continued)

10.4.5 Start-Up and Shutdown Mode

The TPS6128xA automatically powers-up as soon as the input voltage is applied. The device has an internal soft-start circuit that limits the inrush current during start-up. The first phase in the start-up procedure is to bias the output node close to the input level (so called pre-charge phase).

In this operating mode, the device limits its output current to ca. 500mA. Should the output voltage not have reached the input level within a maximum duration of 750 μ s, the device automatically increases its pre-charge current to ca. 2000mA. If the output voltage still fails to reach its target after 1.5ms, a fault condition is declared. After waiting 1ms, a restart is attempted.

When output voltage being close to V_{out} , the device enters into boost startup mode (for Auto Mode only). The device provides a reduced current limit of $\sim 1.25A$ (I2C programable for TPS61280A to set it back to normal current limit) when the output voltage is below pre-set voltage to avoid the high inrush current from battery.

During start-up, it is recommended to keep DC load current draw below 250mA.

The TPS6128xA device contains a thermal regulation loop that monitors the die temperature during the pre-charge phase. If the die temperature rises to high values of about 110 $^{\circ}C$, the device automatically reduces the current to prevent the die temperature from increasing further. Once the die temperature drops about 10 $^{\circ}C$ below the threshold, the device will automatically increase the current to the target value. This function also reduces the current during a short-circuit condition.

When the EN and nBYP pins are set high, the device enters normal operation (that is, automatic dc/dc boost, pass-through mode) and ensures that the output voltage remains above a pre-defined threshold (That is, 3.3V).

Setting the EN pin low (nBYP = 1) forces the TPS6128xA device in shutdown mode with a current consumption of $<8.5\mu A$ typ. In this mode, the output of the converter is regulated to a minimum level so as to limit the input-to-output voltage difference to less than 3.6V (typ). The device is capable of sinking up to 10mA output current and prohibits reverse current flow from the output to the input. For proper operation, the EN pin must be terminated and must not be left floating.

Changing operating mode from auto mode (EN = nBYP = 1) to low I_Q Pass-through mode (EN = nBYP = 0) with device pins EN and nBYP can either be done controlling EN and nBYP pins from same control signal (delay between signal $< 60ns$) or first switching in forced pass-through mode (EN = 1, nBYP = 0) followed by switching to low I_Q Pass-through mode (EN = nBYP = 0).

The TPS6128xA device also features the possibility of shutting the converter's output for a short period of time, either via the nRST/nFAULT (GPIO). Pulling this input low initiates a reset of the converter's output. The sequence is falling edge-triggered and consists of a discharge phase (down to ca. 600mV or lower) of the capacitance located at the converter's output followed by a start-up phase.

Table 2. Mode of Operation

EN Input	nBYP Input	Device State
0	0	The device is shut down in pass-through mode featuring a shutdown current down to ca. 3 μA typ. The load current capability is limited (up to ca. 250mA).
0	1	The device is shut down and the output voltage is reduced to a minimum value ($V_{IN} - V_{OUT} \leq 3.6V$). The device shutdown current is approximately 8.5 μA typ.
1	0	The device is active in forced pass-through mode. The device supply current is approximately 15 μA typ. from the battery. The device is short circuit protected by a current limit of ca.7300mA.
1	1	The device is active in auto mode (dc/dc boost, pass-through). The device supply current is approximately 50 μA typ. from the battery.

10.4.6 Undervoltage Lockout

The under voltage lockout circuit prevents the device from malfunctioning at low input voltages and the battery from excessive discharge. The I2C control interface and the output stage of the converter are disabled once the falling V_{IN} trips the under-voltage lockout threshold V_{UVLO} (2V typ). The device starts operation once the rising V_{IN} trips V_{UVLO} threshold plus its hysteresis of 100 mV at typ. 2.1V.

10.4.7 Thermal Shutdown

As soon as the junction temperature, T_J , exceeds 160°C (typ.) the device goes into thermal shutdown. In this mode the bypass, high-side and low-side MOSFETs are turned-off. When the junction temperature falls below the thermal shutdown minus its hysteresis, the device continuous the operation.

10.4.8 Fault State and Power-Good

The TPS6128xA enters the fault state under any of the followings conditions:

- The output voltage fails to achieve the required level during a start-up phase.
- The output voltage falls out of regulation (in pre-charge mode).
- The device has entered thermal shutdown.

Once a fault is triggered, the regulator stops operating and disconnects the load. After waiting 1ms, the device attempts to restart. The TPS61280A device can be configured to signal a fault condition by pulling the open-drain GPIO pin (nFAULT) low for a short period of time. The nFAULT output provides a falling edge triggered interrupt signal to the host. To ensure proper operation, the GPIO port needs to be pull high quick enough, that is, faster than ca. 200ns. To do so, it is recommended to use a GPIO pull-up resistor in the range of 1kΩ to 10kΩ.

The TPS6128xA (simple logic I/F version) device only provide a power-good output (PG) for signaling the system when the regulator has successfully completed start-up and no faults have occurred. Power-good also functions as an early warning flag for excessive die temperature and overload conditions.

- PG is asserted high when the start-up sequence is successfully completed.
- PG is pulled low when the output voltage falls approximately 10% below its regulation level or the die temperature exceeds 115°C. PG is re-asserted high when the device cools below ca. 100°C.
- Any fault condition causes PG to be de-asserted.
- PG is pulled high when the device is operating in forced pass-through mode (that is, nBYP = L).
- PG is pulled high when the device is in shutdown mode.

10.5 Programming

10.5.1 Serial Interface Description (TPS61280A)

I²C™ is a 2-wire serial interface developed by Philips Semiconductor, now NXP Semiconductors (see I²C-Bus Specification, Version 2.1, January 2000). The bus consists of a data line (SDA) and a clock line (SCL) with pull-up structures. When the bus is *idle*, both SDA and SCL lines are pulled high. All the I²C compatible devices connect to the I²C bus through open drain I/O pins, SDA and SCL. A *master* device, usually a microcontroller or a digital signal processor, controls the bus. The master is responsible for generating the SCL signal and device addresses. The master also generates specific conditions that indicate the START and STOP of data transfer. A *slave* device receives and/or transmits data on the bus under control of the master device.

The TPS6128xA device works as a *slave* and supports the following data transfer *modes*, as defined in the I²C-Bus Specification: standard mode (100 kbps) and fast mode (400 kbps), fast mode plus (1 Mbps) and high-speed mode (3.4 Mbps). The interface adds flexibility to the power supply solution, enabling most functions to be programmed to new values depending on the instantaneous application requirements. Register contents remain intact as long as supply voltage remains above 2.1V.

The data transfer protocol for standard and fast modes is exactly the same, therefore they are referred to as F/S-mode in this document. The protocol for high-speed mode is different from F/S-mode, and it is referred to as HS-mode. The TPS6128xA device supports 7-bit addressing; 10-bit addressing and general call address are not supported. The device 7bit address is defined as ‘111 0101’.

It is recommended that the I²C masters initiates a STOP condition on the I²C bus after the initial power up of SDA and SCL pull-up voltages to ensure reset of the TPS6128xA I²C engine.

10.5.2 Standard-, Fast-, Fast-Mode Plus Protocol

The master initiates data transfer by generating a start condition. The start condition is when a high-to-low transition occurs on the SDA line while SCL is high, as shown in Figure 20. All I²C-compatible devices should recognize a start condition.

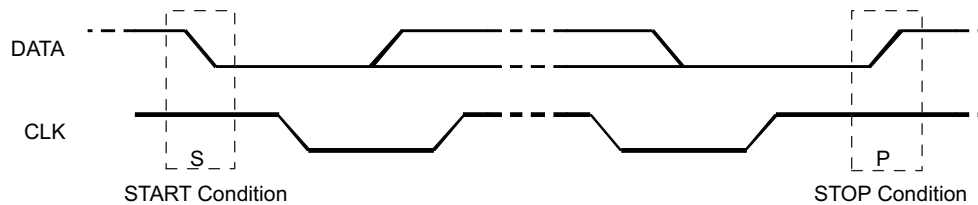

Figure 20. START and STOP Conditions

The master then generates the SCL pulses, and transmits the 7-bit address and the read/write direction bit R/W on the SDA line. During all transmissions, the master ensures that data is valid. A valid data condition requires the SDA line to be stable during the entire high period of the clock pulse (see Figure 21). All devices recognize the address sent by the master and compare it to their internal fixed addresses. Only the slave device with a matching address generates an acknowledge (see Figure 22) by pulling the SDA line low during the entire high period of the ninth SCL cycle. Upon detecting this acknowledge, the master knows that communication link with a slave has been established.

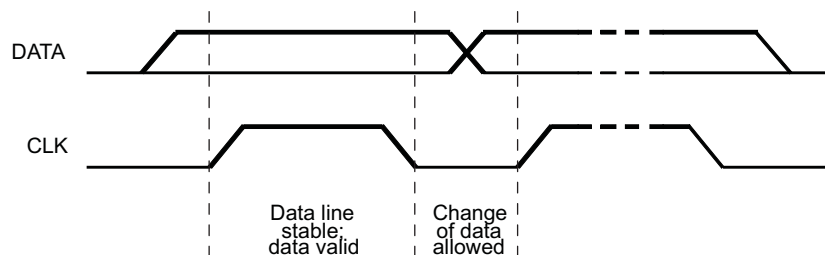

Figure 21. Bit Transfer on the Serial Interface

Programming (continued)

The master generates further SCL cycles to either transmit data to the slave (R/W bit 1) or receive data from the slave (R/W bit 0). In either case, the receiver needs to acknowledge the data sent by the transmitter. So an acknowledge signal can either be generated by the master or by the slave, depending on which one is the receiver. 9-bit valid data sequences consisting of 8-bit data and 1-bit acknowledge can continue as long as necessary.

To signal the end of the data transfer, the master generates a stop condition by pulling the SDA line from low to high while the SCL line is high (see Figure 20). This releases the bus and stops the communication link with the addressed slave. All I²C compatible devices must recognize the stop condition. Upon the receipt of a stop condition, all devices know that the bus is released, and they wait for a start condition followed by a matching address.

Attempting to read data from register addresses not listed in this section will result in 00h being read out.

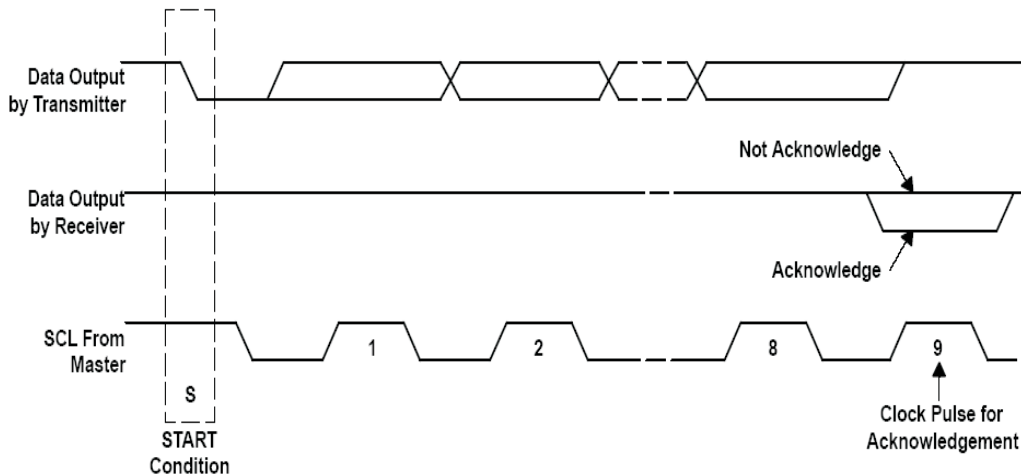

Figure 22. Acknowledge on the I²C Bus

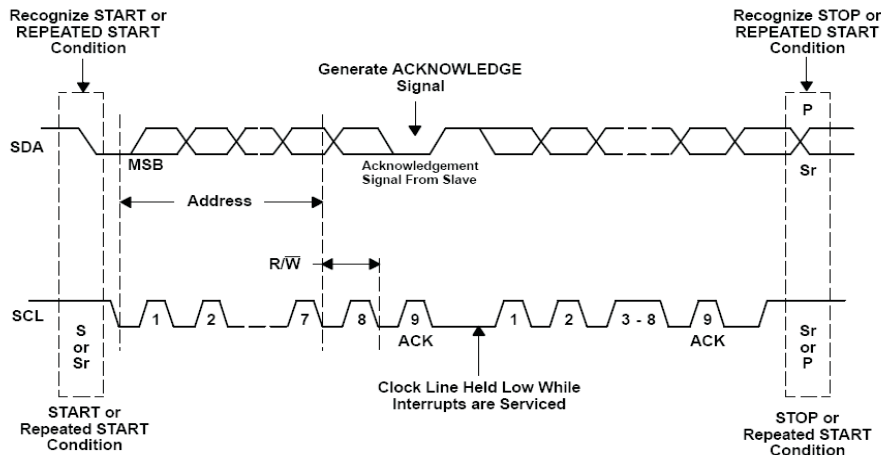

Figure 23. Bus Protocol

Programming (continued)

10.5.3 HS-Mode Protocol

The master generates a start condition followed by a valid serial byte containing HS master code 00001XXX. This transmission is made in F/S-mode at no more than 400 Kbps. No device is allowed to acknowledge the HS master code, but all devices must recognize it and switch their internal setting to support 3.4 Mbps operation.

The master then generates a *repeated start condition* (a repeated start condition has the same timing as the start condition). After this repeated start condition, the protocol is the same as F/S-mode, except that transmission speeds up to 3.4 Mbps are allowed. A stop condition ends the HS-mode and switches all the internal settings of the slave devices to support the F/S-mode. Instead of using a stop condition, repeated start conditions should be used to secure the bus in HS-mode.

Attempting to read data from register addresses not listed in this section will result in 00h being read out.

10.5.4 TPS6128xA I²C Update Sequence

The TPS6128xA requires a start condition, a valid I²C address, a register address byte, and a data byte for a single update. After the receipt of each byte, TPS6128xA device acknowledges by pulling the SDA line low during the high period of a single clock pulse. A valid I²C address selects the TPS6128xA. TPS6128xA performs an update on the falling edge of the acknowledge signal that follows the LSB byte.

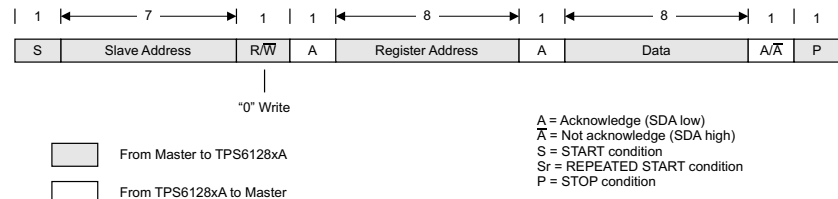

Figure 24. : “Write” Data Transfer Format in Standard-, Fast, Fast-Plus Modes

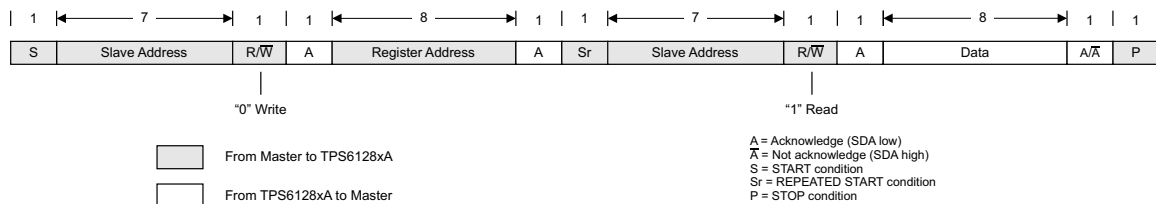

Figure 25. “Read” Data Transfer Format in Standard-, Fast, Fast-Plus Modes

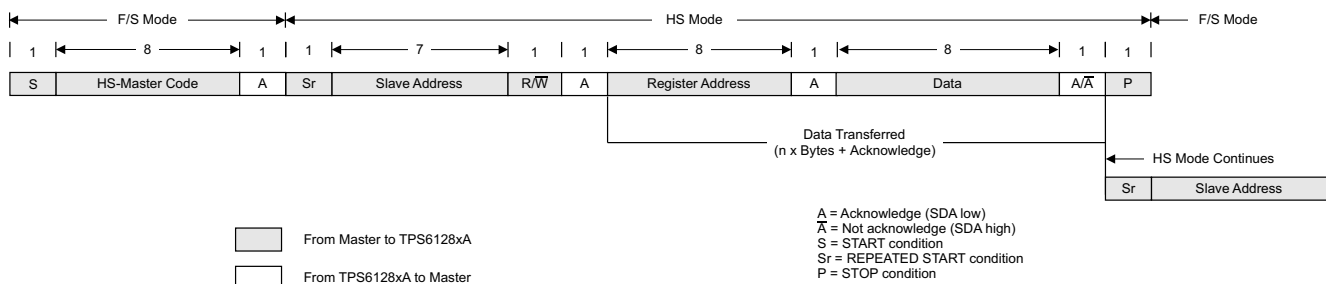

Figure 26. Data Transfer Format in H/S-Mode

10.6 Register Maps

10.6.1 Slave Address Byte

MSB						LSB	
1	1	1	0	1	A1	A0	

The slave address byte is the first byte received following the START condition from the master device.

10.6.2 Register Address Byte

MSB						LSB	
0	0	0	0	0	D2	D1	D0

Following the successful acknowledgment of the slave address, the bus master will send a byte to the TPS6128xA, which will contain the address of the register to be accessed.

10.6.3 I²C Registers, E²PROM, Write Protect

Configuration parameters can be changed by writing the desired values to the appropriate I²C register(s). The I²C registers are volatile and their contents are lost when power is removed from the device. By writing to the [E2PROMCTRL Register](#), it is possible to store the active configuration in non-volatile E²PROM; during power-up, the contents of the E²PROM are copied into the I²C registers and used to configure the device.

NOTE

An active high Write Protect (WP) bit prevents the configuration parameters from being changed by accident. Once the E²PROM memory has been programmed with Write Protect (WP) bit set, its content will be locked and can not be reprogrammed any more.

Configuration parameters can be read from the I²C register(s) or E²PROM registers at any time (the WP bit has no effect on read operations).

10.6.4 E²PROM Configuration Parameters

[Table 3](#) shows the memory map of the configuration parameters.

Table 3. Configuration Memory Map

Register Address	Register Name	Factory Default	Description
01h	CONFIG Register	xxh	Sets miscellaneous configuration bits
02h	VOUTFLOORSET Register	xxh	Sets the floor output voltage threshold boost / pass-through mode change (VSEL = L)
03h	VOUTROOFSET Register	xxh	Sets the roof output voltage threshold boost / pass-through mode change (VSEL = H)
04h	ILIMSET Register	xxh	Sets the average input current limit in dc/dc boost mode
05h	Status Register	xxh	Returns status flags
FFh	E2PROMCTRL Register	00h	Controls whether read and write operations access I ² C or E ² PROM registers

The following procedure details how to save the content of all I²C registers to the E²PROM non-volatile configuration memory.

1. Bus master sends START condition
2. Bus master sends 7-bit slave address plus low R/W bit (for example EAh)
3. TPS6128xA acknowledges (SDA low)
4. Bus master sends address of [E2PROMCTRL Register](#) (FFh)
5. TPS6128xA acknowledges (SDA low)
6. Bus master sends data to be written to the Control Register (C0h)
7. TPS6128xA acknowledges (SDA low)
8. Bus master sends STOP condition

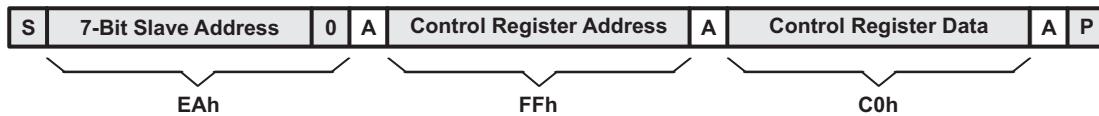

Figure 27. Saving Contents of all I²C Registers to E²PROM

10.6.5 CONFIG Register

Memory location: 0x01

Description	RESET	ENABLE		RESERVED	GPIOCFG	SSFM	MODE_CTRL	
Bits	D7	D6	D5	D4	D3	D2	D1	D0
Memory type	R/W	R/W	R/W	R/W	R/W	R/W	R/W	R/W
Default value	0	0	0	0	0	0	0	1
Stored in E ² PROM?	N	Y	Y	N	Y	Y	Y	Y

Bit	Description
RESET	<p>Device reset bit.</p> <p>0: Normal operation.</p> <p>1: Default values are set to all internal registers. The device operation is cycled (ON-OFF-ON), that is, the converter is disabled for a short period of time and the output is reset.</p>
ENABLE[1:0]	<p>Device enable bits.</p> <p>00: Device operation follows hardware control signal (refer to Table 2).</p> <p>01: Device operates in auto transition mode (dc/dc boost, bypass) regardless of the nBYP control signal (EN = 1).</p> <p>10: Device is forced in pass-through mode regardless of the nBYP control signal (EN = 1).</p> <p>11: Device is in shutdown mode. The output voltage is reduced to a minimum value (VIN - VOUT ≤ 3.6V) regardless of the nBYP control signal (EN = 1).</p>
RESERVED	<p>Reserved bit.</p> <p>This bit is reserved for future use. During write operations data intended for this bit is ignored, and during read operations 0 is returned.</p>
GPIOCFG	<p>GPIO port configuration bit.</p> <p>0: GPIO port is configured to support manual reset input (nRST) and interrupt generation output (nFAULT).</p> <p>1: GPIO port is configured as a device mode selection input.</p>
SSFM	<p>Spread modulation control.</p> <p>0: Spread spectrum modulation is disabled.</p> <p>1: Spread spectrum modulation is enabled in PWM mode.</p>
MODE_CTRL[1:0]	<p>Device mode of operation bits.</p> <p>00: Device operation follows hardware control signal (GPIO must be configured as mode selection input).</p> <p>01: PFM with automatic transition into PWM operation.</p> <p>10: Forced PWM operation.</p> <p>11: PFM with automatic transition into PWM operation (VSEL = L), forced PWM operation (VSEL = H).</p>

10.6.6 VOUTFLOORSET Register

Memory location: 0x02

Description	RESERVED	RESERVED	RESERVED	VOUTFLOOR_TH				
Bits	D7	D6	D5	D4	D3	D2	D1	D0
Memory type	R/W	R/W	R/W	R/W	R/W	R/W	R/W	R/W
Default value	0	0	0	0	0	1	1	0
Stored in E ² PROM?	N	N	N	Y	Y	Y	Y	Y

Bit	Description
RESERVED	Reserved bit. This bit is reserved for future use. During write operations data intended for this bit is ignored, and during read operations 0 is returned.
VOUTFLOOR_TH[4:0]	Output voltage threshold, dc/dc boost / pass-through mode change. 00000: 2.850V 00001: 2.900V 00010: 2.950V 00011: 3.000V 00100: 3.050V 00101: 3.100V 00110: 3.150V 00111: 3.200V 01000: 3.250V 01001: 3.300V 01010: 3.350V 01011: 3.400V 01100: 3.450V 01101: 3.500V 01110: 3.550V 01111: 3.600V 10000: 3.650V 10001: 3.700V 10010: 3.750V 10011: 3.800V 10100: 3.850V 10101: 3.900V 10110: 3.950V 10111: 4.000V 11000: 4.050V 11001: 4.100V 11010: 4.150V 11011: 4.200V 11100: 4.250V 11101: 4.300V 11110: 4.350V 11111: 4.400V

10.6.7 VOUTROOFSET Register

Memory location: 0x03

Description	RESERVED	RESERVED	RESERVED	VOUTROOF_TH				
Bits	D7	D6	D5	D4	D3	D2	D1	D0
Memory type	R/W	R/W	R/W	R/W	R/W	R/W	R/W	R/W
Default value	0	0	0	0	1	0	1	0
Stored in E ² PROM?	N	N	N	Y	Y	Y	Y	Y

Bit	Description
RESERVED	Reserved bit. This bits is reserved for future use. During write operations data intended for this bit is ignored, and during read operations 0 is returned.
VOUTROOF_TH[4:0]	Output voltage threshold, dc/dc boost / pass-through mode change. 00000: 2.850V 00001: 2.900V 00010: 2.950V 00011: 3.000V 00100: 3.050V 00101: 3.100V 00110: 3.150V 00111: 3.200V 01000: 3.250V 01001: 3.300V 01010: 3.350V 01011: 3.400V 01100: 3.450V 01101: 3.500V 01110: 3.550V 01111: 3.600V 10000: 3.650V 10001: 3.700V 10010: 3.750V 10011: 3.800V 10100: 3.850V 10101: 3.900V 10110: 3.950V 10111: 4.000V 11000: 4.050V 11001: 4.100V 11010: 4.150V 11011: 4.200V 11100: 4.250V 11101: 4.300V 11110: 4.350V 11111: 4.400V

10.6.8 ILIMSET Register

Memory location: 0x04

Description	RESERVED	RESERVED	ILIM OFF	Soft-start	ILIM			
Bits	D7	D6	D5	D4	D3	D2	D1	D0
Memory type	R/W	R/W	R/W	R/W	R/W	R/W	R/W	R/W
Default value	0	0	0	1	1	0	1	1
Stored in E ² PROM?	N	N	N	Y	Y	Y	Y	Y

Bit	Description
RESERVED	Reserved bit. This bit is reserved for future use. During write operations data intended for this bit is ignored, and during read operations 0 is returned.
ILIM[3:0]	Inductor valley current limit in dc/dc boost mode (COUTRNG bit = 0)⁽¹⁾. 1000: 1500mA 1001: 2000mA 1010: 2500mA 1011: 3000mA 1100: 3500mA 1101: 4000mA 1110: 4500mA 1111: 5000mA
Soft-Start	Soft-start selection bit. 0: DC/DC boost soft-start current is limited per ILIM bit settings 1: DC/DC boost soft-start current is limited to ca. 1250mA inductor valley current
ILIM OFF	Enable/Disable Current Limit 0 : Current Limit Enabled 1 : Current Limit Disabled

(1) Refer to [Start-Up and Shutdown Mode](#) section for additional information.

10.6.9 Status Register

Memory location: 0x05

Description	TSD	HOTDIE	DCDCMODE	OPMODE	ILIMPT	ILIMBST	FAULT	PGOOD
Bits	D7	D6	D5	D4	D3	D2	D1	D0
Memory type	R	R	R	R	R	R	R	R
Default value	0	0	0	0	0	0	0	0
Stored in E ² PROM?	N	N	N	N	N	N	N	N

Bit	Description
TSD	Thermal shutdown status bit. 0: Normal operation. 1: Thermal shutdown tripped. This flag is reset after readout.
HOTDIE	Instantaneous die temperature bit. 0: $T_J < 115^\circ\text{C}$. 1: $T_J > 115^\circ\text{C}$.
DCDCMODE	DC/DC mode of operation status bit. 1: Device operates in PFM mode. 0: Device operates in PWM mode.
OPMODE	Device mode of operation status bit. 0: Device operates in pass-through mode. 1: Device operates in dc/dc mode.
ILIMPT	Current limit status bit (pass-through mode). 0: Normal operation. 1: Indicates that the bypass FET current limit has triggered. This flag is reset after readout.
ILIMBST	Current limit status bit (dc/dc boost mode). 0: Normal operation. 1: Indicates that the average input current limit has triggered for 1.5ms in dc/dc boost mode. This flag is reset after readout.
FAULT	FAULT status bit. 0: Normal operation. 1: Indicates that a fault condition has occurred. This flag is reset after readout.
PGOOD	Power Good status bit. 0: Indicates the output voltage is out of regulation. 1: Indicates the output voltage is within its nominal range. This bit is set if the converter is forced in pass-through mode.

10.6.10 E2PROMCTRL Register

Memory location: 0xFF

Description	WEN	WP	ISE2PROMWP	RESERVED	RESERVED	RESERVED	RESERVED	RESERVED
Bits	D7	D6	D5	D4	D3	D2	D1	D0
Memory type	R/W	R/W	R	R/W	R/W	R/W	R/W	R/W
Default value	0	0	0	0	0	0	0	0
Stored in E²PROM?	N	Y	N	N	N	N	N	N

Bit	Description
WEN	E²PROM Write Enable bit. 0: No operation. 1: Forces the contents of selected I ² C register bits to be copied into E ² PROM, thereby making them the default values during power-up. When the contents of all the I ² C register bits have been written to the E ² PROM, the device automatically resets this bit.
WP	E²PROM Write Protect bit. 0: Normal operation. 1: Forces the E ² PROM content to be locked following a write sequence (WEN = 1). This protects the E ² PROM content from undesirable write actions making it virus safe. This process is non reversible.
ISE2PROMWP	E²PROM Write Protect Status bit. 0: E ² PROM content is not write protected. E ² PROM content can still be updated. 1: E ² PROM content is write protected. E ² PROM content is permanently locked.
RESERVED	Reserved bit. This bits is reserved for future use. During write operations data intended for this bit is ignored, and during read operations 0 is returned.

11 Application and Implementation

NOTE

Information in the following applications sections is not part of the TI component specification, and TI does not warrant its accuracy or completeness. TI's customers are responsible for determining suitability of components for their purposes. Customers should validate and test their design implementation to confirm system functionality.

11.1 Application Information

The devices are step up dc/dc converters with true bypass function integrated. They are typically used as preregulators with input voltage ranges from 2.3V to 4.8V, extend the battery run time and overcome input current and input voltage limitations of the system being powered.

While the input voltage higher than boost/bypass threshold, the high-efficient integrated pass-through path connects the battery to the powered system directly.

If the input voltage becomes lower than boost/bypass threshold, the device seamlessly transitions into boost mode operation with a maximum available output current of 3 A.

The following design procedure can be used to select component values for the TPS61281A and TPS61282A (also applicable for TPS61280A just by I²C program).

11.2 Typical Application

11.2.1 TPS61281A with 2.5V-4.35 V_{IN}, 1500 mA Output Current (TPS61280A with I²C Programmable)

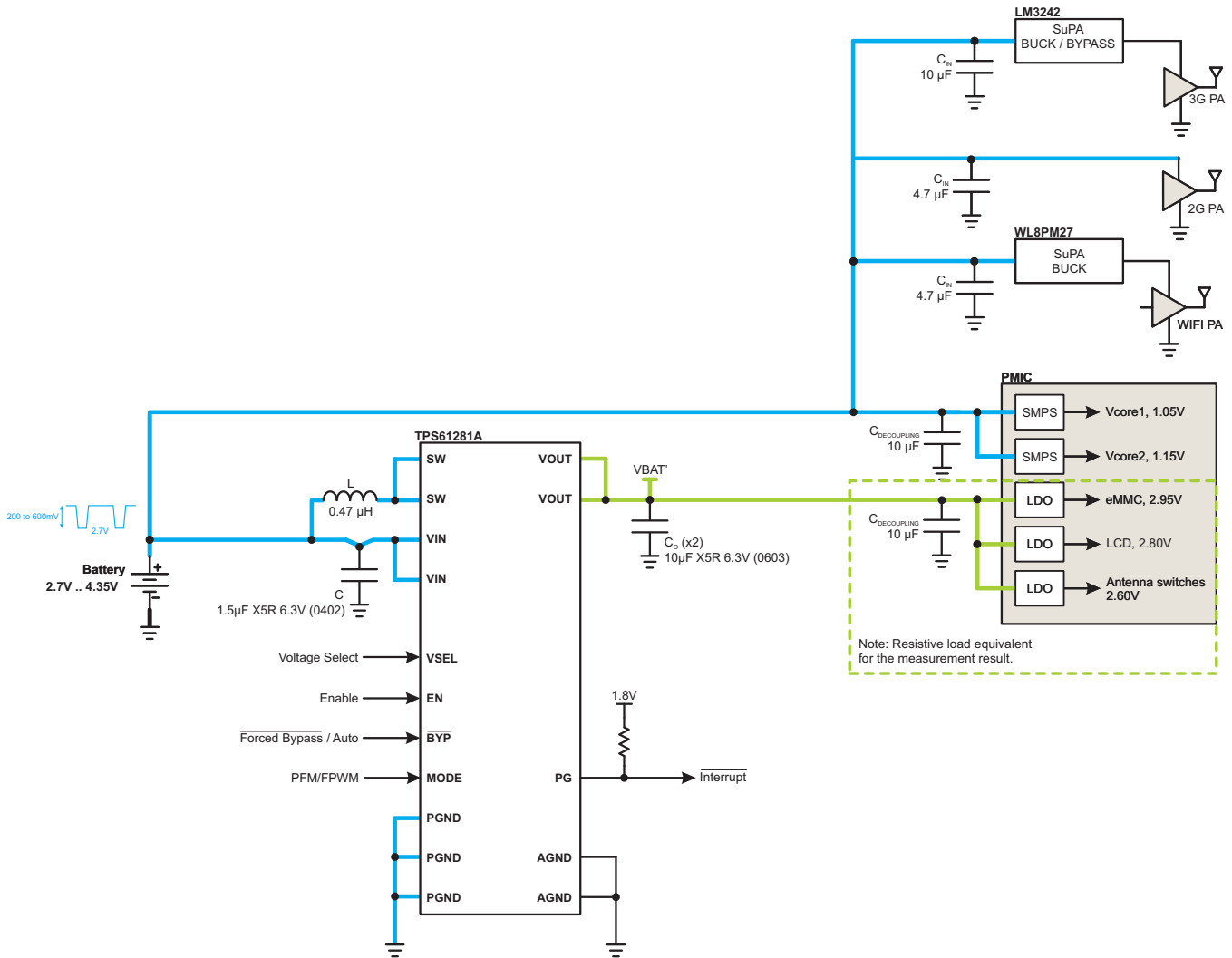

Figure 28. TPS61281A Application Circuit with 1500mA Output Current

11.2.1.1 Design Requirement

Table 4. Design Parameters

REFERENCE	DESCRIPTION	SAMPLE VALUES
V _{IN}	Input voltage range	2.5V-4.35V
V _{OUT}	Output voltage range at V _{SEL} = Low	V _{OUT} = 3.15V if V _{IN} ≤ 3.15V, V _{OUT} = V _{IN} if V _{IN} > 3.15V
V _{OUT}	Output voltage range V _{SEL} = High	V _{OUT} = 3.35V if V _{IN} ≤ 3.35V, V _{OUT} = V _{IN} if V _{IN} > 3.35V
I _{OUT}	Output current	1500mA

11.2.1.2 Detailed Design Parameters

11.2.1.2.1 Inductor Selection

A boost converter normally requires two main passive components for storing energy during the conversion, an inductor and an output capacitor are required. It is advisable to select an inductor with a saturation current rating higher than the possible peak current flowing through the power switches.

The inductor peak current varies as a function of the load, the input and output voltages and can be estimated using [Equation 8](#).

$$I_{L(\text{PEAK})} = \frac{V_{\text{IN}} \times D}{2 \times f \times L} + \frac{I_{\text{OUT}}}{(1-D) \times \eta} \quad \text{with } D = 1 - \frac{V_{\text{IN}}}{V_{\text{OUT}}} \quad (8)$$

Selecting an inductor with insufficient saturation performance can lead to excessive peak current in the converter. This could eventually harm the device and reduce its reliability.

When selecting the inductor, as well as the inductance, parameters of importance are: maximum current rating, series resistance, and operating temperature. The inductor DC current rating should be greater than the maximum input average current, refer to [Equation 9](#) and the [Current Limit Operation](#) section for more details.

$$I_{L(\text{DC})} = \frac{V_{\text{OUT}}}{V_{\text{IN}}} \times \frac{1}{\eta} \times I_{\text{OUT}} \quad (9)$$

The TPS6128xA series of step-up converters have been optimized to operate with an effective inductance in the range of 200nH to 800nH. Larger or smaller inductor values can be used to optimize the performance of the device for specific operating conditions. For more details, see the [Checking Loop Stability](#) section.

In high-frequency converter applications, the efficiency is essentially affected by the inductor AC resistance (that is, quality factor) and to a smaller extent by the inductor DCR value. To achieve high efficiency operation, care should be taken in selecting inductors featuring a quality factor above 25 at the switching frequency. Increasing the inductor value produces lower RMS currents, but degrades transient response. For a given physical inductor size, increased inductance usually results in an inductor with lower saturation current.

The total losses of the coil consist of both the losses in the DC resistance, $R_{(\text{DC})}$, and the following frequency-dependent components:

- The losses in the core material (magnetic hysteresis loss, especially at high switching frequencies)
- Additional losses in the conductor from the skin effect (current displacement at high frequencies)
- Magnetic field losses of the neighboring windings (proximity effect)
- Radiation losses

For good efficiency, the inductor's DC resistance should be less than 30mΩ. The following inductor series from different suppliers have been used with the TPS6128xA converters.

Table 5. List of Inductors

SERIES	DIMENSIONS (in mm)	DC INPUT CURRENT LIMIT SETTING
DFE252010C	2.5 x 2.0 x 1.0 max. height	≤3000 mA
DFE252012C	2.5 x 2.0 x 1.2 max. height	≤3500 mA
DFR252010C	2.5 x 2.0 x 1.0 max. height	≤3000 mA
DFE252012C	2.5 x 2.0 x 1.2 max. height	≤3500 mA
DFE252012P	2.5 x 2.0 x 1.2 max. height	≤3500 mA
DFE201610C	2.0 x 1.6 x 1.0 max. height	≤2000 mA
DFE201612C	2.0 x 1.6 x 1.2 max. height	≤3000 mA
DFE201612P	2.0 x 1.6 x 1.2 max. height	≤3000 mA

11.2.1.2.2 Output Capacitor

For the output capacitor, it is recommended to use small ceramic capacitors placed as close as possible to the V_{OUT} and GND pins of the IC. If, for any reason, the application requires the use of large capacitors which can not be placed close to the IC, using a smaller ceramic capacitor in parallel to the large one is highly recommended. This small capacitor should be placed as close as possible to the V_{OUT} and GND pins of the IC. To get an estimate of the recommended minimum output capacitance, [Equation 10](#) can be used.

$$C_{\text{MIN}} = \frac{I_{\text{OUT}} \times (V_{\text{OUT}} - V_{\text{IN}})}{f \times \Delta V \times V_{\text{OUT}}}$$

where

- f is the switching frequency which is 2.3MHz (typ.) and ΔV is the maximum allowed output ripple. (10)

With a chosen ripple voltage of 20mV, a minimum effective capacitance of 10 μ F is needed. The total ripple is larger due to the ESR and ESL of the output capacitor. This additional component of the ripple can be calculated using [Equation 11](#)

$$\Delta V_{\text{OUT(ESR)}} = \text{ESR} \times \left(\frac{I_{\text{OUT}}}{1 - D} + \frac{\Delta I_L}{2} \right) \quad (11)$$

$$\Delta V_{\text{OUT(ESL)}} = \text{ESL} \times \left(\frac{I_{\text{OUT}}}{1 - D} + \frac{\Delta I_L}{2} - I_{\text{OUT}} \right) \times \frac{1}{t_{\text{SW(RISE)}}} \quad (12)$$

$$\Delta V_{\text{OUT(ESL)}} = \text{ESL} \times \left(\frac{I_{\text{OUT}}}{1 - D} - \frac{\Delta I_L}{2} - I_{\text{OUT}} \right) \times \frac{1}{t_{\text{SW(FALL)}}}$$

where

- I_{OUT} = output current of the application
 - D = duty cycle
 - ΔI_L = inductor ripple current
 - $t_{\text{SW(RISE)}}$ = switch node rise time
 - $t_{\text{SW(FALL)}}$ = switch node fall time
 - ESR = equivalent series resistance of the used output capacitor
 - ESL = equivalent series inductance of the used output capacitor
- (13)

An MLCC capacitor with twice the value of the calculated minimum should be used due to DC bias effects. This is required to maintain control loop stability. The output capacitor requires either an X7R or X5R dielectric. Y5V and Z5U dielectric capacitors, aside from their wide variation in capacitance over temperature, become resistive at high frequencies. There are no additional requirements regarding minimum ESR. Larger capacitors cause lower output voltage ripple as well as lower output voltage drop during load transients.

In applications featuring high (pulsed) load currents (e.g. ≥ 2 Amps), it is recommended to run the converter with a reasonable amount of effective output capacitance and low-ESL device, for instance x2 22 μ F X5R 6.3V (0603) MLCC capacitors connected in parallel with a 1 μ F X5R 6.3V (0306-2T) MLCC LL capacitor.

DC bias effect: high cap. ceramic capacitors exhibit DC bias effects, which have a strong influence on the device's effective capacitance. Therefore the right capacitor value has to be chosen very carefully. Package size and voltage rating in combination with material are responsible for differences between the rated capacitor value and its effective capacitance. For instance, a 10 μ F X5R 6.3V (0603) MLCC capacitor would typically show an effective capacitance of less than 5 μ F (under 3.5V bias condition, high temperature).

For RF Power Amplifier applications, the output capacitor loading is combined between the dc/dc converter and the RF Power Amplifier (x2 10 μ F X5R 6.3V (0603) + PA input cap 4.7 μ F X5R 6.3V (0402)) are recommended.

High values of output capacitance are mainly achieved by putting capacitors in parallel. This reduces the overall series resistance (ESR) to very low values. This results in almost no voltage ripple at the output and therefore the regulation circuit has no voltage drop to react on. Nevertheless to guarantee accurate output voltage regulation even with very low ESR the regulation loop can switch to a pure comparator regulation scheme.

11.2.1.2.3 Input Capacitor

Multilayer ceramic capacitors are an excellent choice for input decoupling of the step-up converter as they have extremely low ESR and are available in small footprints. Input capacitors should be located as close as possible to the device. While a 4.7 μ F input capacitor is sufficient for most applications, larger values may be used to reduce input current ripple without limitations.

Take care when using only ceramic input capacitors. When a ceramic capacitor is used at the input and the power is being supplied through long wires, such as from a wall adapter, a load step at the output can induce ringing at the VIN pin. This ringing can couple to the output and be mistaken as loop instability or could even damage the part. Additional "bulk" capacitance (electrolytic or tantalum) should in this circumstance be placed between C_1 and the power source lead to reduce ringing than can occur between the inductance of the power source leads and C_1 .

11.2.1.2.4 Checking Loop Stability

The first step of circuit and stability evaluation is to look from a steady-state perspective at the following signals:

- Switching node, SW
- Inductor current, I_L
- Output ripple voltage, $V_{OUT(AC)}$

These are the basic signals that need to be measured when evaluating a switching converter. When the switching waveform shows large duty cycle jitter or the output voltage or inductor current shows oscillations, the regulation loop may be unstable. This is often a result of board layout and/or L-C combination.

As a next step in the evaluation of the regulation loop, the load transient response is tested. The time between the application of the load transient and the turn on of the P-channel MOSFET, the output capacitor must supply all of the current required by the load. V_{OUT} immediately shifts by an amount equal to $\Delta I_{(LOAD)} \times ESR$, where ESR is the effective series resistance of C_{OUT} . $\Delta I_{(LOAD)}$ begins to charge or discharge C_{OUT} generating a feedback error signal used by the regulator to return V_{OUT} to its steady-state value. The results are most easily interpreted when the device operates in PWM mode.

During this recovery time, V_{OUT} can be monitored for settling time, overshoot or ringing that helps judge the converter's stability. Without any ringing, the loop has usually more than 45° of phase margin. Because the damping factor of the circuitry is directly related to several resistive parameters (that is, MOSFET $r_{DS(on)}$) that are temperature dependant, the loop stability analysis has to be done over the input voltage range, load current range, and temperature range.

The TPS6128xA series of step-up converters have been optimized to operate with a effective inductance in the range of 200nH to 800nH and with output capacitors in the range of 8uF to 100µF. The internal compensation is optimized for an output filter of $L = 0.5\mu H$ and $C_O = 15\mu F$.

Table 6. Component List

REFERENCE	DESCRIPTION	PART NUMBER, MANUFACTURER ⁽¹⁾
C_{IN}	1.5µF, 6.3V, 0402, X5R ceramic	GRM155R60J155ME80D
C_{OUT}	2 x 10µF, 6.3V, 0603, X5R ceramic	2 x GRM188R60J106ME84
L	470nH, 47mΩ, 2.5mm x 2.0mm x 1.2mm	DFE252012CR470

(1) See [Third-Party Products Disclaimer](#)

11.2.1.3 Application Performance Curves

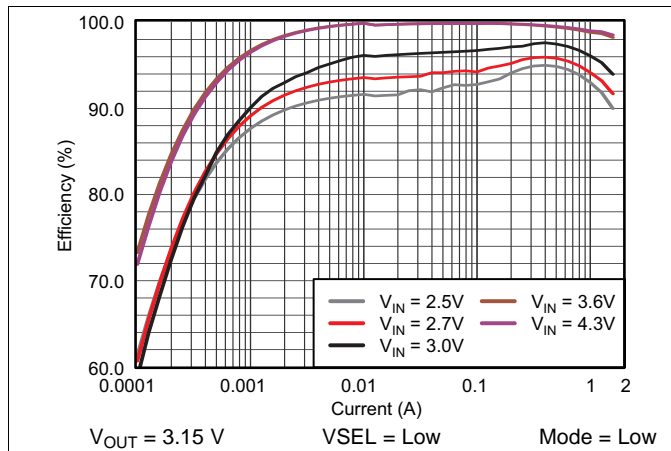

Figure 29. TPS61281A Efficiency vs Output Current

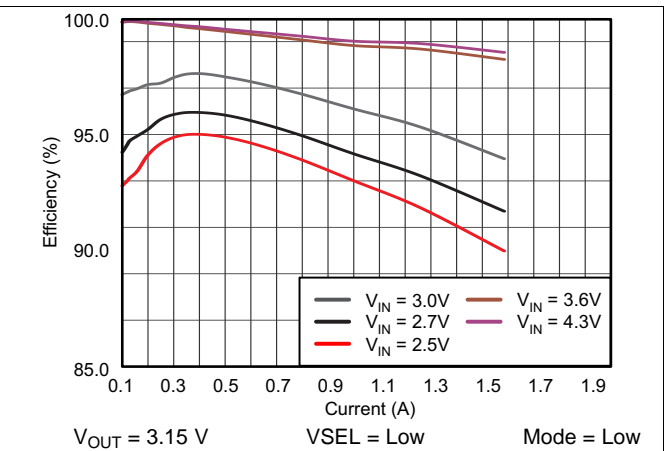

Figure 30. TPS61281A Efficiency vs Output Current

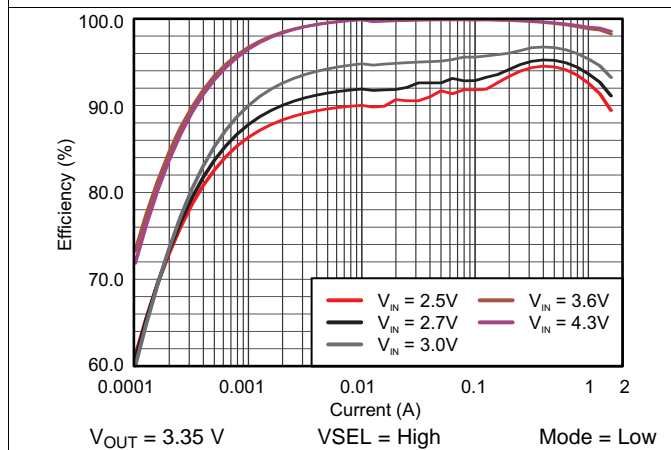

Figure 31. TPS61281A Efficiency vs Output Current

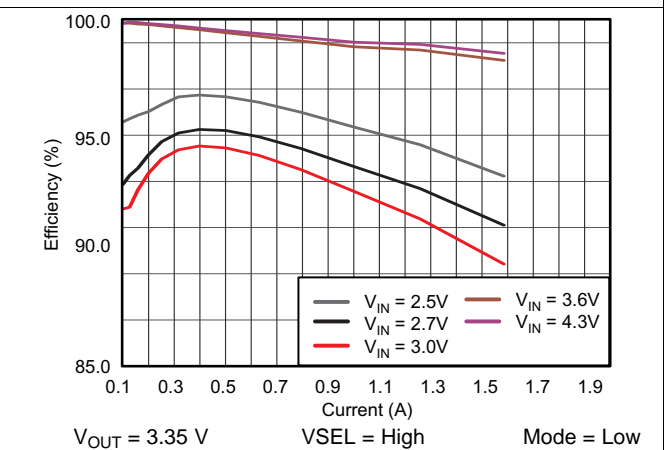

Figure 32. TPS61281A Efficiency vs Output Current

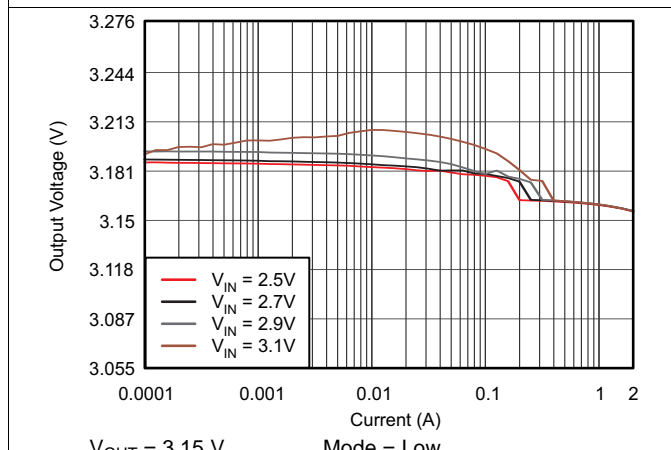

Figure 33. TPS61281A DC Output Voltage vs Output Current

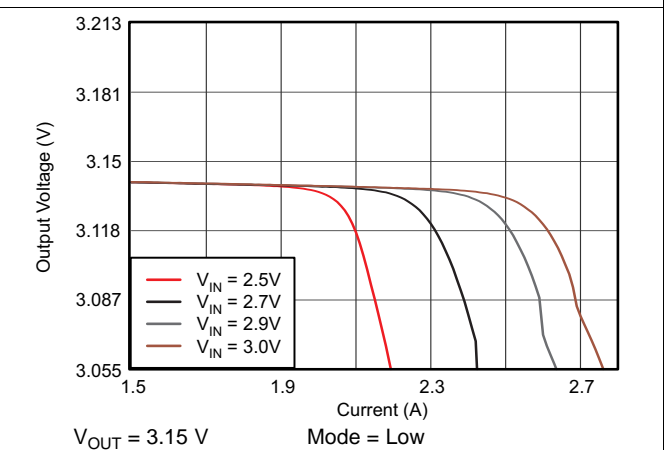

Figure 34. TPS61281A DC Output Voltage vs Output Current

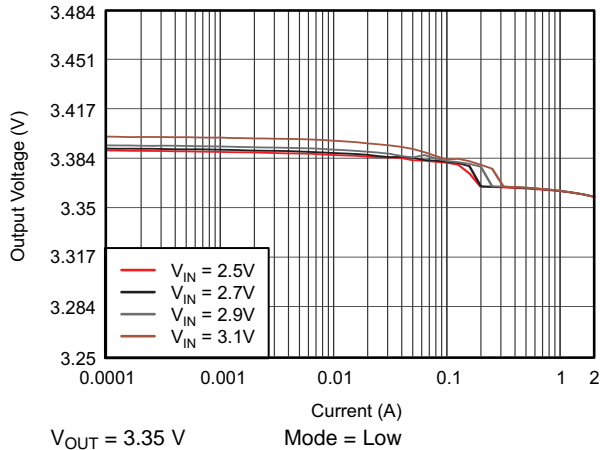

Figure 35. TPS61281A DC Output Voltage vs Output Current

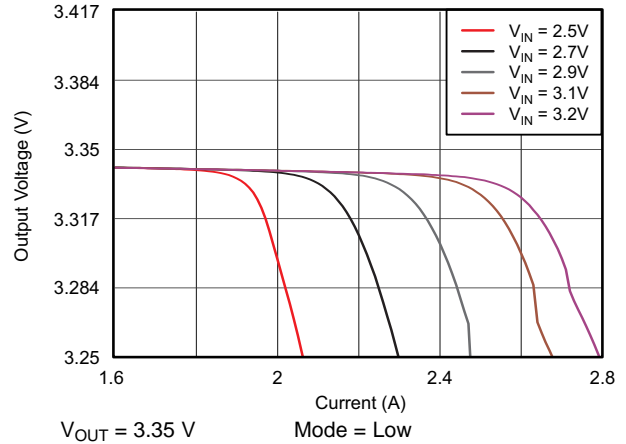

Figure 36. TPS61281A DC Output Voltage vs Output Current

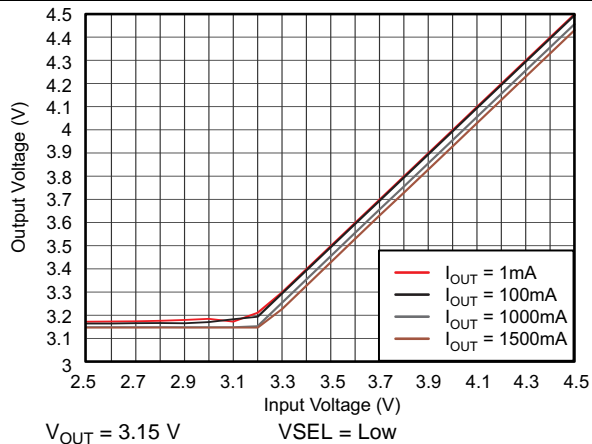

Figure 37. TPS61281A DC Output Voltage vs Input Voltage

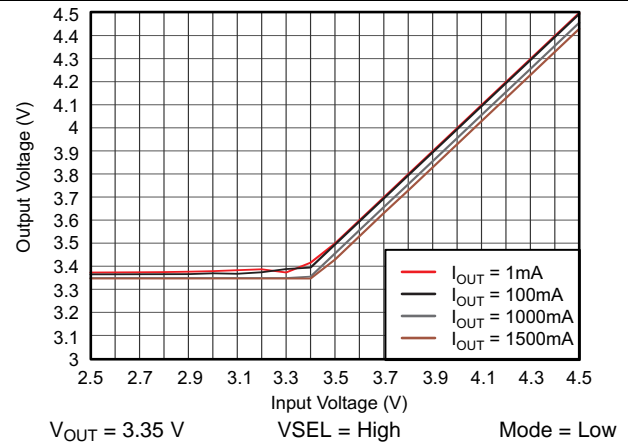

Figure 38. TPS61281A DC Output Voltage vs Input Voltage

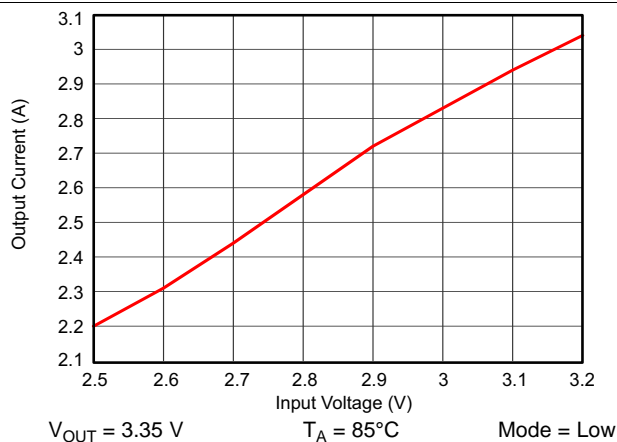

Figure 39. TPS61281A Maximum Output Current vs Input Voltage

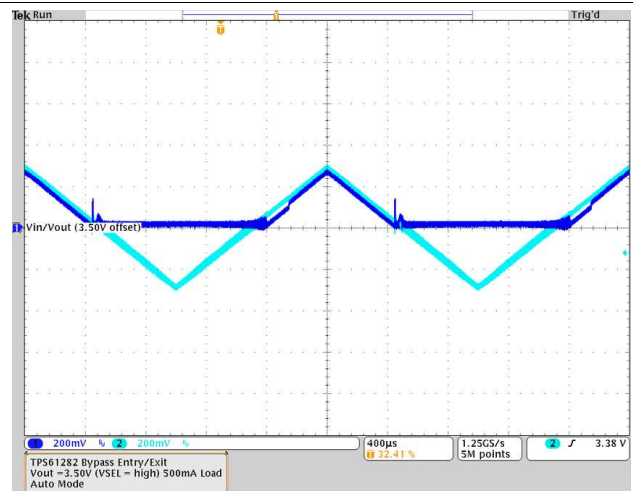

Figure 40. Boost to Pass-Through Mode Exit / Entry

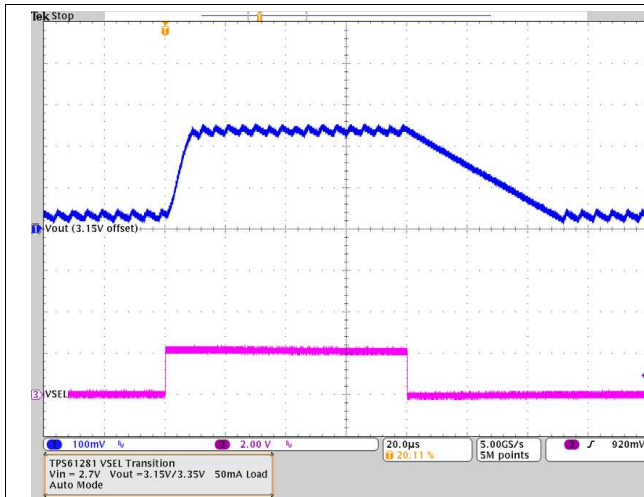

Figure 41. TPS61281A Dynamic Voltage Management (VSEL) Load Current 50 mA

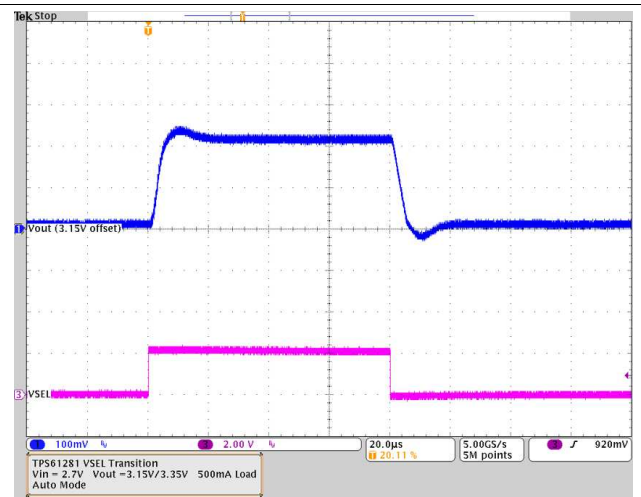

Figure 42. TPS61281A Dynamic Voltage Management (VSEL) Load Current 500 mA

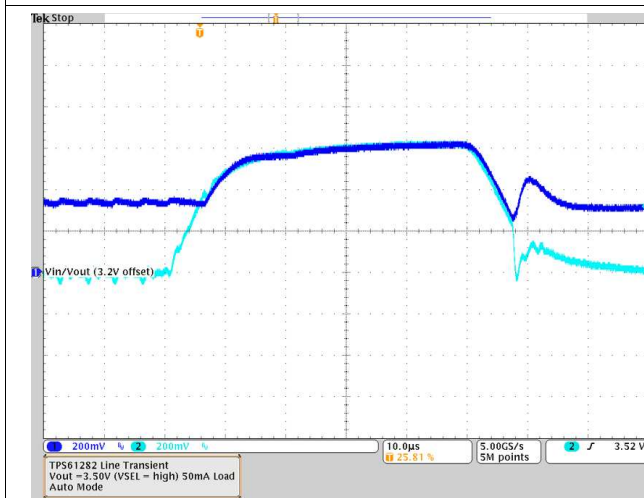

Figure 43. TPS61282A Forced Pass-Through to Boost Mode Transition

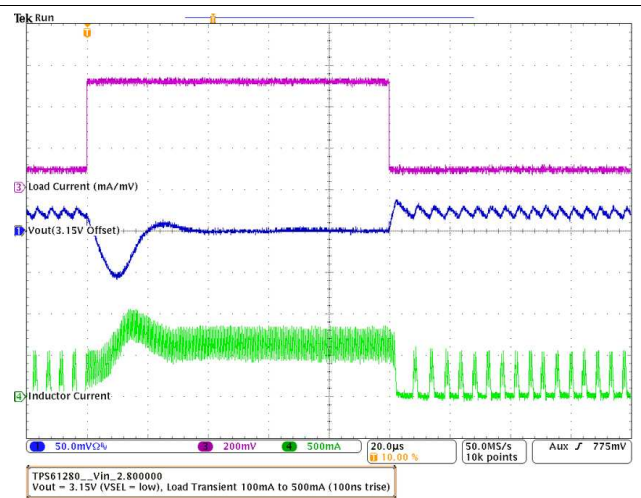

Figure 44. TPS61280A, 81A Load Transient Response In PFM/PWM Operation

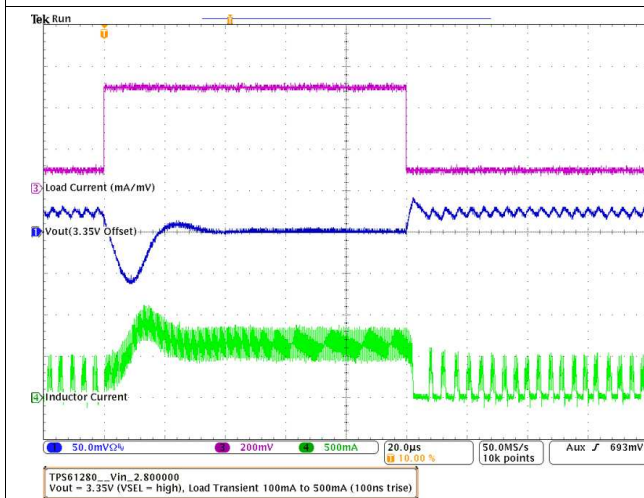

Figure 45. TPS61280A, 81A Load Transient Response In PFM/PWM Operation

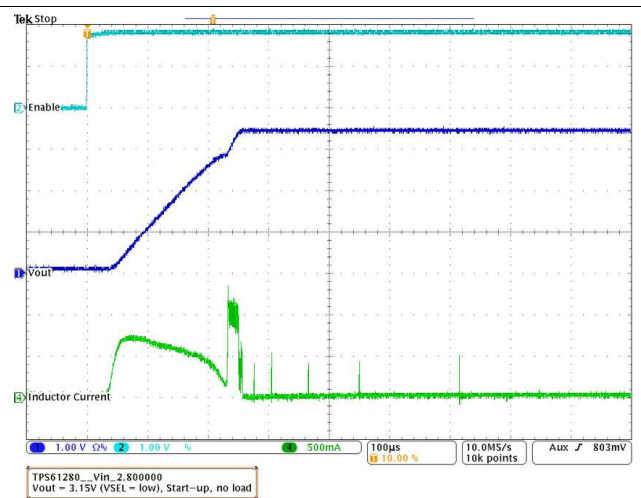
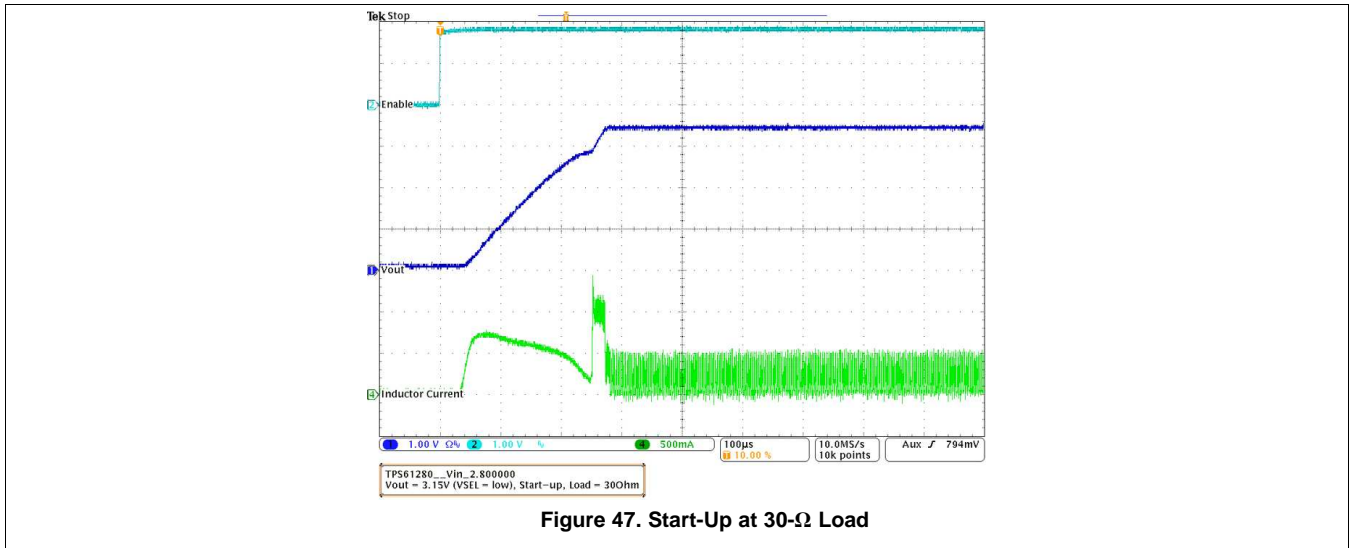

Figure 46. Start-Up at No Load



11.2.2 TPS61282A with 2.5V-4.35 V_{IN}, 2000 mA Output Current (TPS61280A with I²C Programmable)

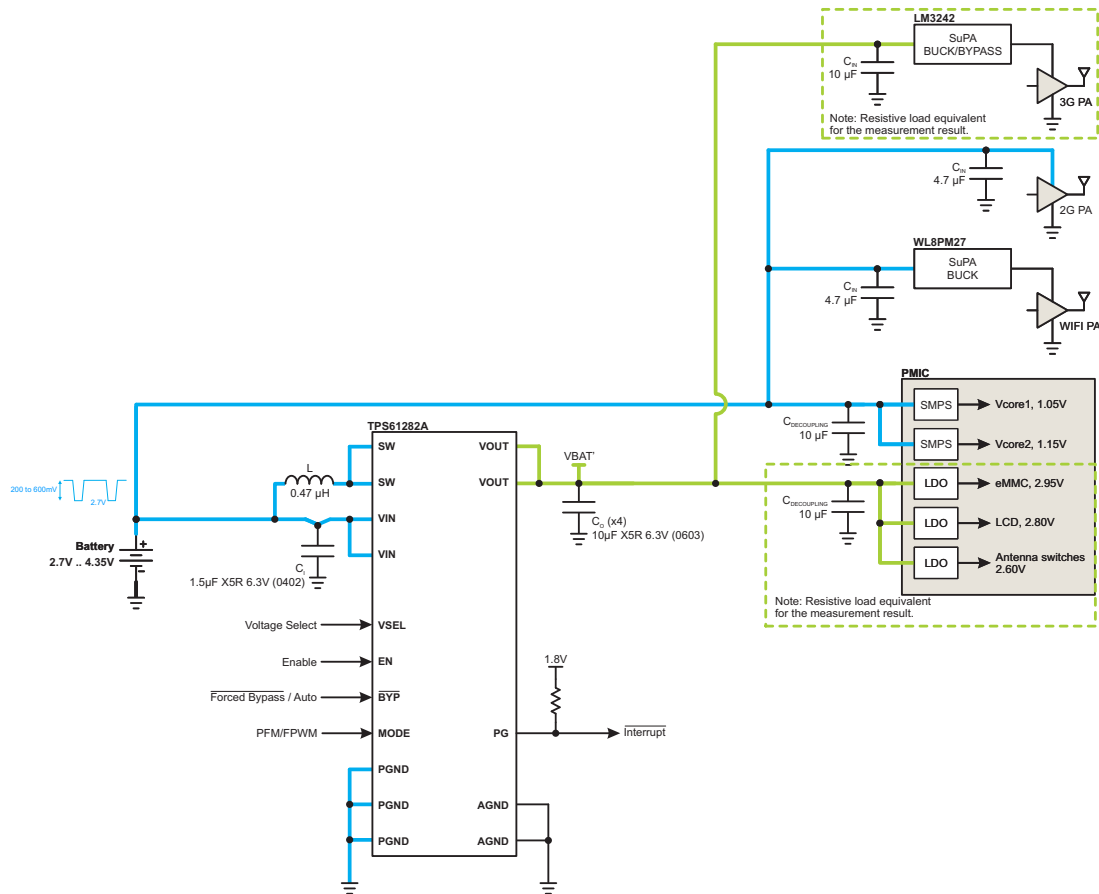

Figure 48. TPS61282A Application Circuit with 2000 mA Output Current

11.2.2.1 Design Requirements

Table 7. Design Parameters

REFERENCE	DESCRIPTION	PART NUMBER, MANUFACTURER
V _{IN}	Input voltage range	2.5 V to 4.35 V
V _{OUT}	Output voltage range at V _{SEL} =Low	V _{OUT} =3.3 V if V _{IN} ≤3.3 V, V _{OUT} = V _{IN} if V _{IN} >3.3 V
V _{OUT}	Output voltage range V _{SEL} =High	V _{OUT} =3.5 V if V _{IN} ≤3.5 V, V _{OUT} = V _{IN} if V _{IN} >3.5 V
I _{OUT}	Output Current	2000 mA

Table 8. Component List

REFERENCE	DESCRIPTION	PART NUMBER, MANUFACTURER ⁽¹⁾
C _I	1.5µF, 6.3V, 0402, X5R ceramic	GRM155R60J155ME80D
C _O	4 x 10µF, 6.3V, 0603, X5R ceramic	4 x GRM188R60J106ME84
L	470nH, 47mΩ, 2.5mm x 2.0mm x 1.2mm	DFE252012CR470

(1) See [Third-Party Products Disclaimer](#)

11.2.2.2 Detailed Design Procedures

See [TPS61281A with 2.5V-4.35 V_{IN}, 1500 mA Output Current \(TPS61280A with I²C Programmable\)](#) for all Detailed Design Procedures.

11.2.2.3 Application Performance Curves

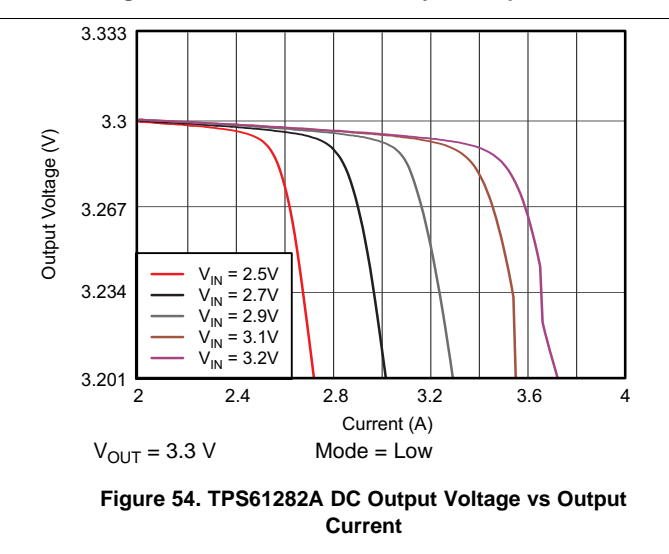
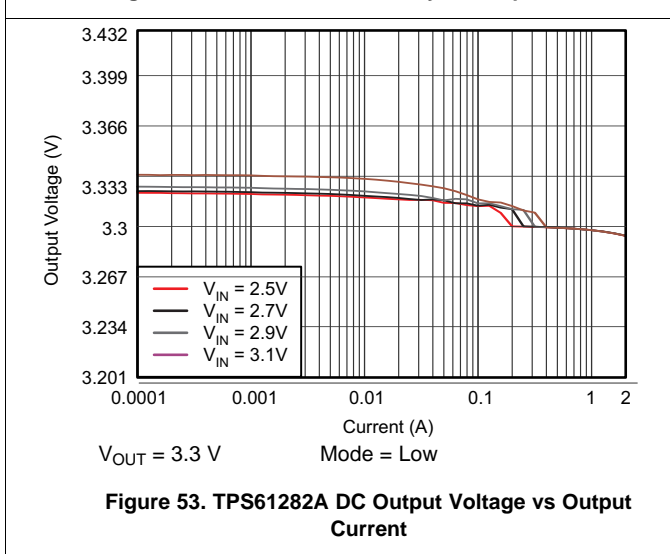
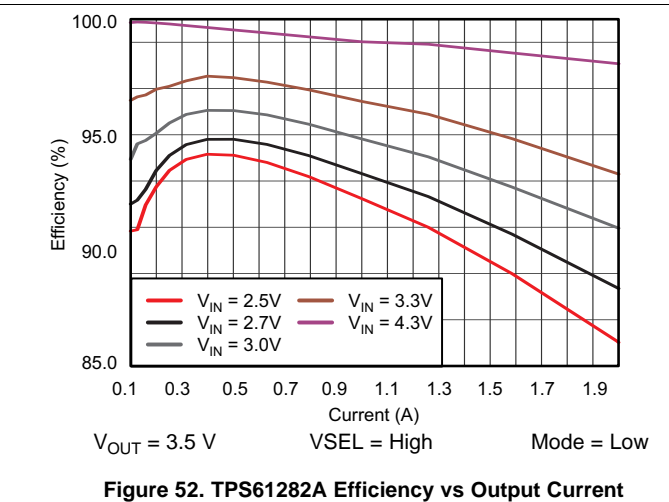
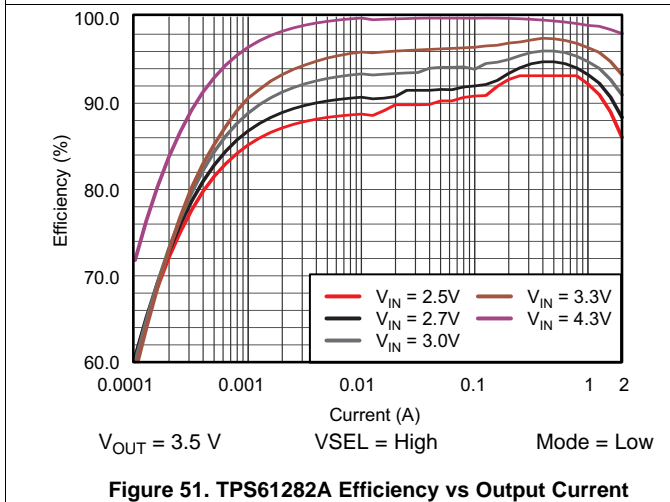
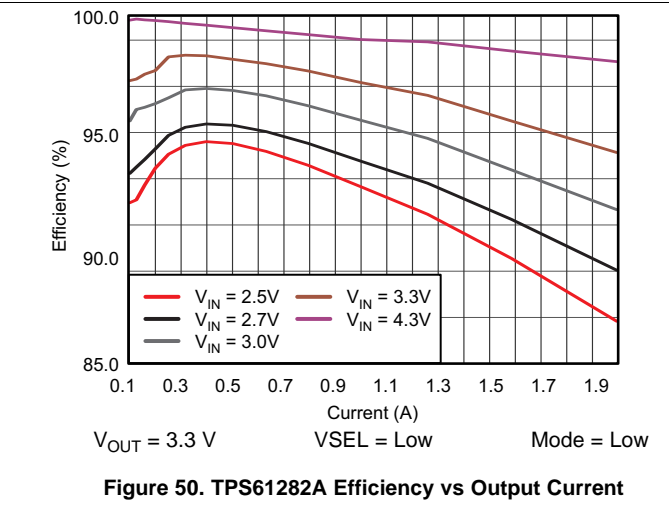
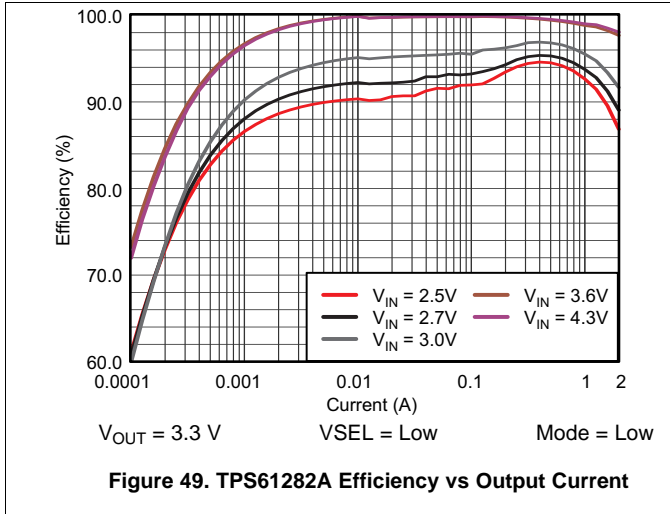

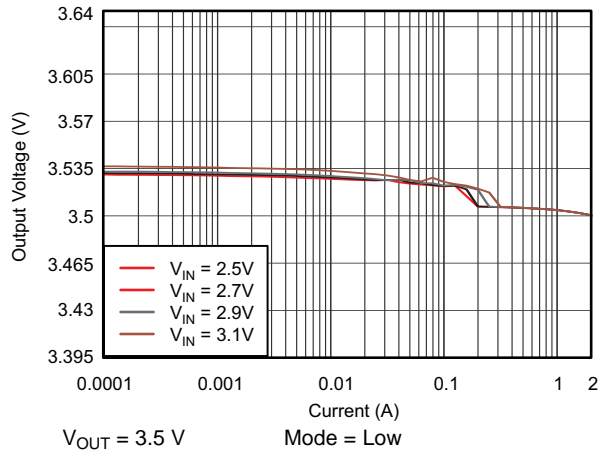

Figure 55. TPS61282A DC Output Voltage vs Output Current

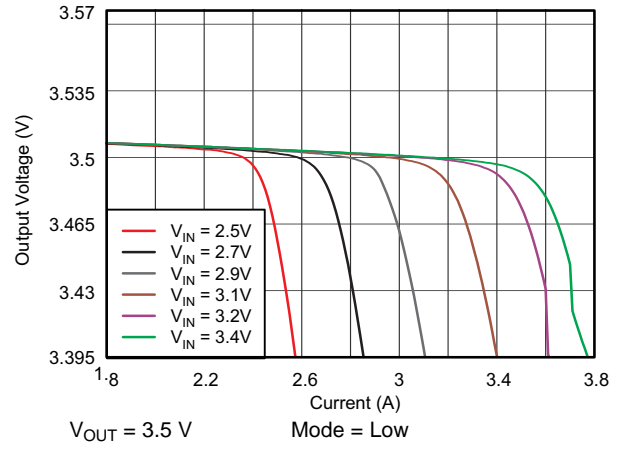

Figure 56. TPS61282A DC Output Voltage vs Output Current

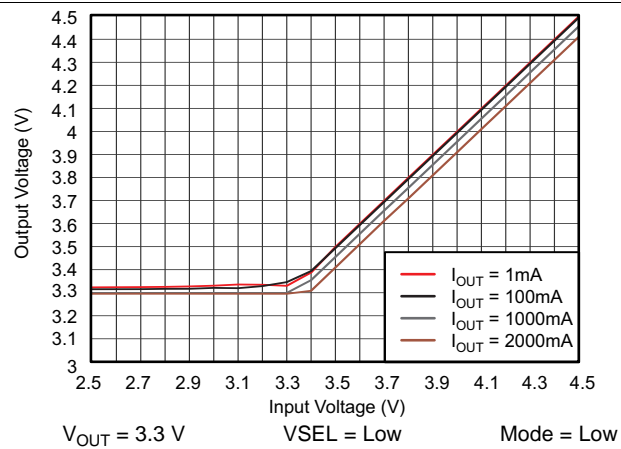

Figure 57. TPS61282A DC Output Voltage vs Input Voltage

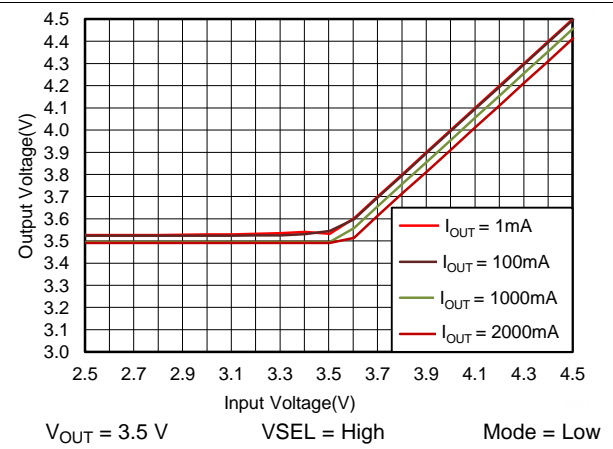

Figure 58. TPS61282A DC Output Voltage vs Input Voltage

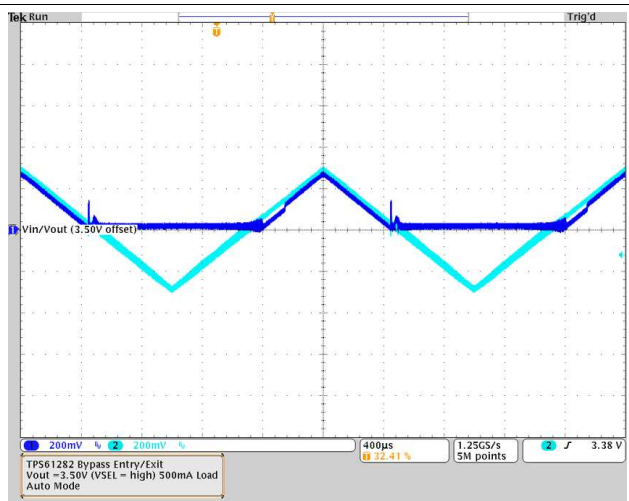

Figure 59. Boost to Pass-Through Mode Exit / Entry

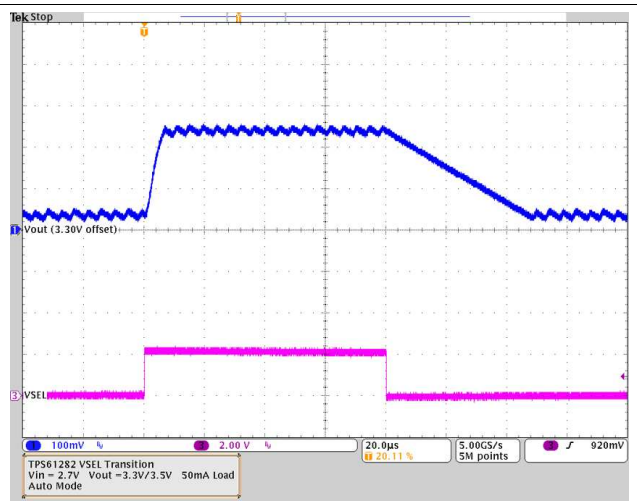

Figure 60. TPS61282A Dynamic Voltage Management (VSEL) Load Current 50mA

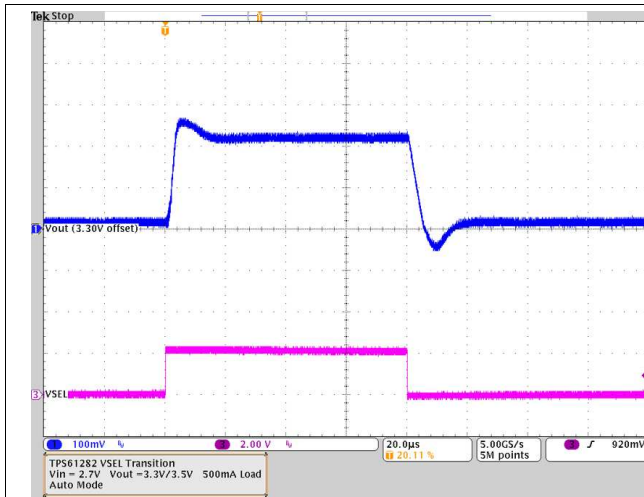

Figure 61. TPS61282A Dynamic Voltage Management (VSEL) Load Current 500mA

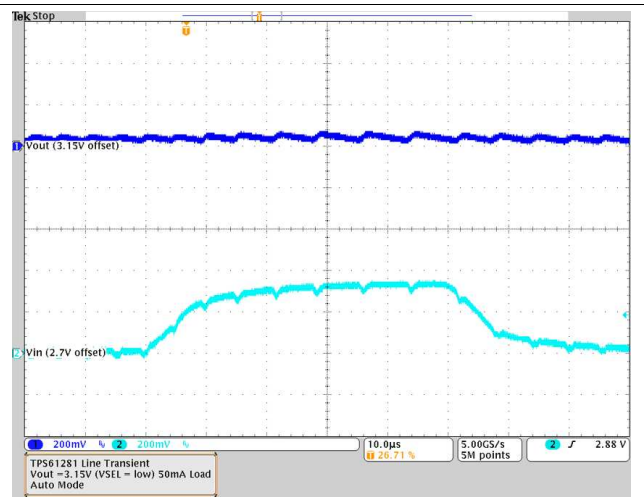

Figure 62. TPS61282A Line Transient

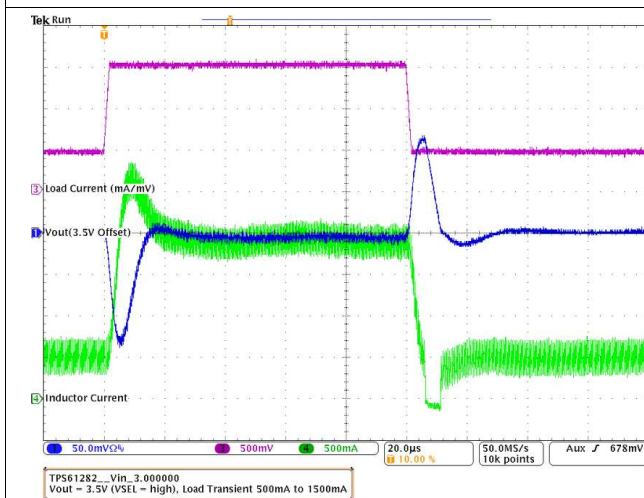

Figure 63. TPS61282A Load Transient Response In PWM Operation

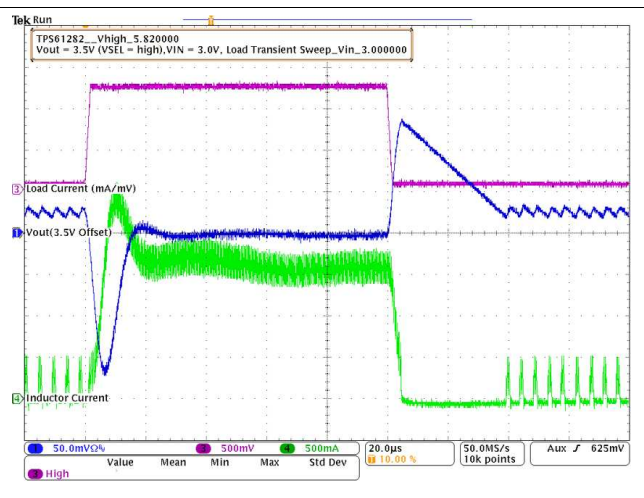

Figure 64. TPS61282A Load Transient Response In PFM/PWM Operation

12 Power Supply Recommendations

The devices are designed to operate from an input voltage supply range between 2.3 V and 4.8 V. This input supply should be well regulated. If the input supply is located more than a few inches from the TPS61280A, TPS61281A or TPS61282A converter additional bulk capacitance may be required in addition to the ceramic bypass capacitors. An electrolytic or tantalum capacitor with a value of 47 μF is a typical choice.

13 Layout

13.1 Layout Guidelines

- For all switching power supplies, the layout is an important step in the design, especially at high peak currents and high switching frequencies.
- If the layout is not carefully done, the regulator could show stability problems as well as EMI problems.
- Therefore, use wide and short traces for the main current path and for the power ground tracks.
- To minimize voltage spikes at the converter's output:
 - Place the output capacitor(s) as close as possible to GND and V_{OUT} , as shown in [Figure 65](#).
 - The input capacitor and inductor should also be placed as close as possible to the IC.
 - Use a common ground node for power ground and a different one for control ground to minimize the effects of ground noise.
 - Connect these ground nodes at any place close to the ground pins of the IC.
 - Junction-to-ambient thermal resistance is highly application and board-layout dependent.
 - It is suggested to maximize the pour area for all planes other than SW. Especially the ground pour should be set to fill available PWB surface area and tied to internal layers with a cluster of thermal vias.

13.2 Layout Example

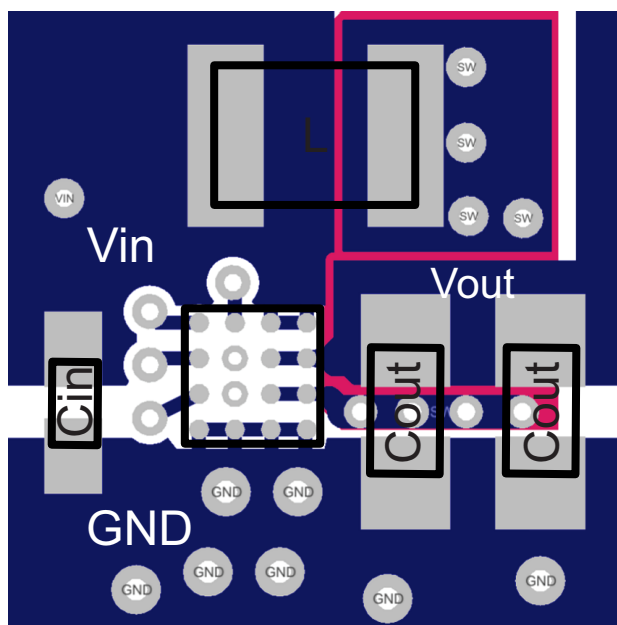

Figure 65. Suggested Layout (Top)

13.3 Thermal Information

Implementation of integrated circuits in low-profile and fine-pitch surface-mount packages typically requires special attention to power dissipation. Many system-dependent issues such as thermal coupling, airflow, added heat sinks and convection surfaces, and the presence of other heat-generating components affect the power-dissipation limits of a given component.

Three basic approaches for enhancing thermal performance are listed below:

- Improving the power dissipation capability of the PCB design
- Improving the thermal coupling of the component to the PCB
- Introducing airflow in the system

As power demand in portable designs is more and more important, designers must figure the best trade-off between efficiency, power dissipation and solution size. Due to integration and miniaturization, junction temperature can increase significantly which could lead to bad application behaviors (that is, premature thermal shutdown or worst case reduce device reliability).

Junction-to-ambient thermal resistance is highly application and board-layout dependent. In applications where high maximum power dissipation exists, special care must be paid to thermal dissipation issues in board design. The device operating junction temperature (T_J) should be kept below 125°C.

14 Device and Documentation Support

14.1 Device Support

14.1.1 Third-Party Products Disclaimer

TI'S PUBLICATION OF INFORMATION REGARDING THIRD-PARTY PRODUCTS OR SERVICES DOES NOT CONSTITUTE AN ENDORSEMENT REGARDING THE SUITABILITY OF SUCH PRODUCTS OR SERVICES OR A WARRANTY, REPRESENTATION OR ENDORSEMENT OF SUCH PRODUCTS OR SERVICES, EITHER ALONE OR IN COMBINATION WITH ANY TI PRODUCT OR SERVICE.

14.2 Related Links

The table below lists quick access links. Categories include technical documents, support and community resources, tools and software, and quick access to sample or buy.

Table 9. Related Links

PARTS	PRODUCT FOLDER	SAMPLE & BUY	TECHNICAL DOCUMENTS	TOOLS & SOFTWARE	SUPPORT & COMMUNITY
TPS61280A	Click here	Click here	Click here	Click here	Click here
TPS61281A	Click here	Click here	Click here	Click here	Click here
TPS61282A	Click here	Click here	Click here	Click here	Click here

14.3 Receiving Notification of Documentation Updates

To receive notification of documentation updates, navigate to the device product folder on ti.com. In the upper right corner, click on *Alert me* to register and receive a weekly digest of any product information that has changed. For change details, review the revision history included in any revised document.

14.4 Community Resources

The following links connect to TI community resources. Linked contents are provided "AS IS" by the respective contributors. They do not constitute TI specifications and do not necessarily reflect TI's views; see TI's [Terms of Use](#).

TI E2E™ Online Community *TI's Engineer-to-Engineer (E2E) Community*. Created to foster collaboration among engineers. At e2e.ti.com, you can ask questions, share knowledge, explore ideas and help solve problems with fellow engineers.

Design Support *TI's Design Support* Quickly find helpful E2E forums along with design support tools and contact information for technical support.

14.5 Trademarks

E2E is a trademark of Texas Instruments.

I²C is a trademark of NXP Semiconductors.

All other trademarks are the property of their respective owners.

14.6 Electrostatic Discharge Caution



These devices have limited built-in ESD protection. The leads should be shorted together or the device placed in conductive foam during storage or handling to prevent electrostatic damage to the MOS gates.

14.7 Glossary

SLYZ022 — *TI Glossary*.

This glossary lists and explains terms, acronyms, and definitions.

15 Mechanical, Packaging, and Orderable Information

The following pages include mechanical packaging and orderable information. This information is the most current data available for the designated devices. This data is subject to change without notice and revision of this document. For browser-based versions of this data sheet, refer to the left-hand navigation.

15.1 Package Summary

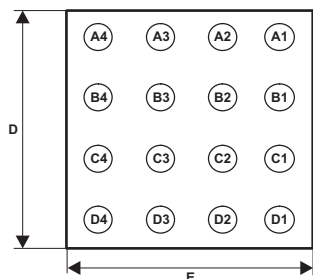

**Figure 66. CHIP SCALE PACKAGE
(BOTTOM VIEW)**

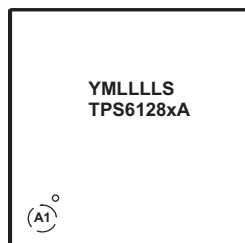

**Figure 67. CHIP SCALE PACKAGE
(TOP VIEW)**

Code:

- YM — Year Month date code
- LLLL — Lot trace code
- S — Assembly site code

15.2 Chip Scale Package Dimensions

The TPS6128xA device is available in a 16-bump chip scale package (YFF, NanoFree™). The package dimensions are given as:

- D = ca. 1666 ±30 μm
- E = ca. 1666 ±30 μm

PACKAGING INFORMATION

Orderable Device	Status (1)	Package Type	Package Drawing	Pins	Package Qty	Eco Plan (2)	Lead/Ball Finish (6)	MSL Peak Temp (3)	Op Temp (°C)	Device Marking (4/5)	Samples
TPS61280AYFFR	ACTIVE	DSBGA	YFF	16	3000	Green (RoHS & no Sb/Br)	SNAGCU	Level-1-260C-UNLIM	-40 to 85	TPS 61280A	Samples
TPS61280AYFFT	ACTIVE	DSBGA	YFF	16	250	Green (RoHS & no Sb/Br)	SNAGCU	Level-1-260C-UNLIM	-40 to 85	TPS 61280A	Samples
TPS61281AYFFR	ACTIVE	DSBGA	YFF	16	3000	Green (RoHS & no Sb/Br)	SNAGCU	Level-1-260C-UNLIM	-40 to 85	TPS 61281A	Samples
TPS61281AYFFT	ACTIVE	DSBGA	YFF	16	250	Green (RoHS & no Sb/Br)	SNAGCU	Level-1-260C-UNLIM	-40 to 85	TPS 61281A	Samples
TPS61282AYFFR	ACTIVE	DSBGA	YFF	16	3000	Green (RoHS & no Sb/Br)	SNAGCU	Level-1-260C-UNLIM	-40 to 85	TPS 61282A	Samples
TPS61282AYFFT	ACTIVE	DSBGA	YFF	16	250	Green (RoHS & no Sb/Br)	SNAGCU	Level-1-260C-UNLIM	-40 to 85	TPS 61282A	Samples

(1) The marketing status values are defined as follows:

ACTIVE: Product device recommended for new designs.

LIFEBUY: TI has announced that the device will be discontinued, and a lifetime-buy period is in effect.

NRND: Not recommended for new designs. Device is in production to support existing customers, but TI does not recommend using this part in a new design.

PREVIEW: Device has been announced but is not in production. Samples may or may not be available.

OBSOLETE: TI has discontinued the production of the device.

(2) Eco Plan - The planned eco-friendly classification: Pb-Free (RoHS), Pb-Free (RoHS Exempt), or Green (RoHS & no Sb/Br) - please check <http://www.ti.com/productcontent> for the latest availability information and additional product content details.

TBD: The Pb-Free/Green conversion plan has not been defined.

Pb-Free (RoHS): TI's terms "Lead-Free" or "Pb-Free" mean semiconductor products that are compatible with the current RoHS requirements for all 6 substances, including the requirement that lead not exceed 0.1% by weight in homogeneous materials. Where designed to be soldered at high temperatures, TI Pb-Free products are suitable for use in specified lead-free processes.

Pb-Free (RoHS Exempt): This component has a RoHS exemption for either 1) lead-based flip-chip solder bumps used between the die and package, or 2) lead-based die adhesive used between the die and leadframe. The component is otherwise considered Pb-Free (RoHS compatible) as defined above.

Green (RoHS & no Sb/Br): TI defines "Green" to mean Pb-Free (RoHS compatible), and free of Bromine (Br) and Antimony (Sb) based flame retardants (Br or Sb do not exceed 0.1% by weight in homogeneous material)

(3) MSL, Peak Temp. - The Moisture Sensitivity Level rating according to the JEDEC industry standard classifications, and peak solder temperature.

(4) There may be additional marking, which relates to the logo, the lot trace code information, or the environmental category on the device.

(5) Multiple Device Markings will be inside parentheses. Only one Device Marking contained in parentheses and separated by a "~" will appear on a device. If a line is indented then it is a continuation of the previous line and the two combined represent the entire Device Marking for that device.

⁽⁶⁾ Lead/Ball Finish - Orderable Devices may have multiple material finish options. Finish options are separated by a vertical ruled line. Lead/Ball Finish values may wrap to two lines if the finish value exceeds the maximum column width.

Important Information and Disclaimer: The information provided on this page represents TI's knowledge and belief as of the date that it is provided. TI bases its knowledge and belief on information provided by third parties, and makes no representation or warranty as to the accuracy of such information. Efforts are underway to better integrate information from third parties. TI has taken and continues to take reasonable steps to provide representative and accurate information but may not have conducted destructive testing or chemical analysis on incoming materials and chemicals. TI and TI suppliers consider certain information to be proprietary, and thus CAS numbers and other limited information may not be available for release.

In no event shall TI's liability arising out of such information exceed the total purchase price of the TI part(s) at issue in this document sold by TI to Customer on an annual basis.

TAPE AND REEL INFORMATION

QUADRANT ASSIGNMENTS FOR PIN 1 ORIENTATION IN TAPE

*All dimensions are nominal

Device	Package Type	Package Drawing	Pins	SPQ	Reel Diameter (mm)	Reel Width W1 (mm)	A0 (mm)	B0 (mm)	K0 (mm)	P1 (mm)	W (mm)	Pin1 Quadrant
TPS61280AYFFR	DSBGA	YFF	16	3000	180.0	8.4	1.78	1.78	0.69	4.0	8.0	Q1
TPS61280AYFFT	DSBGA	YFF	16	250	180.0	8.4	1.78	1.78	0.69	4.0	8.0	Q1
TPS61281AYFFT	DSBGA	YFF	16	250	180.0	8.4	1.78	1.78	0.69	4.0	8.0	Q1
TPS61282AYFFR	DSBGA	YFF	16	3000	180.0	8.4	1.78	1.78	0.69	4.0	8.0	Q1
TPS61282AYFFT	DSBGA	YFF	16	250	180.0	8.4	1.78	1.78	0.69	4.0	8.0	Q1

TAPE AND REEL BOX DIMENSIONS

*All dimensions are nominal

Device	Package Type	Package Drawing	Pins	SPQ	Length (mm)	Width (mm)	Height (mm)
TPS61280AYFFR	DSBGA	YFF	16	3000	182.0	182.0	20.0
TPS61280AYFFT	DSBGA	YFF	16	250	182.0	182.0	20.0
TPS61281AYFFT	DSBGA	YFF	16	250	182.0	182.0	20.0
TPS61282AYFFR	DSBGA	YFF	16	3000	182.0	182.0	20.0
TPS61282AYFFT	DSBGA	YFF	16	250	182.0	182.0	20.0

YFF0016

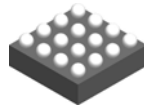

PACKAGE OUTLINE

DSBGA - 0.625 mm max height

DIE SIZE BALL GRID ARRAY

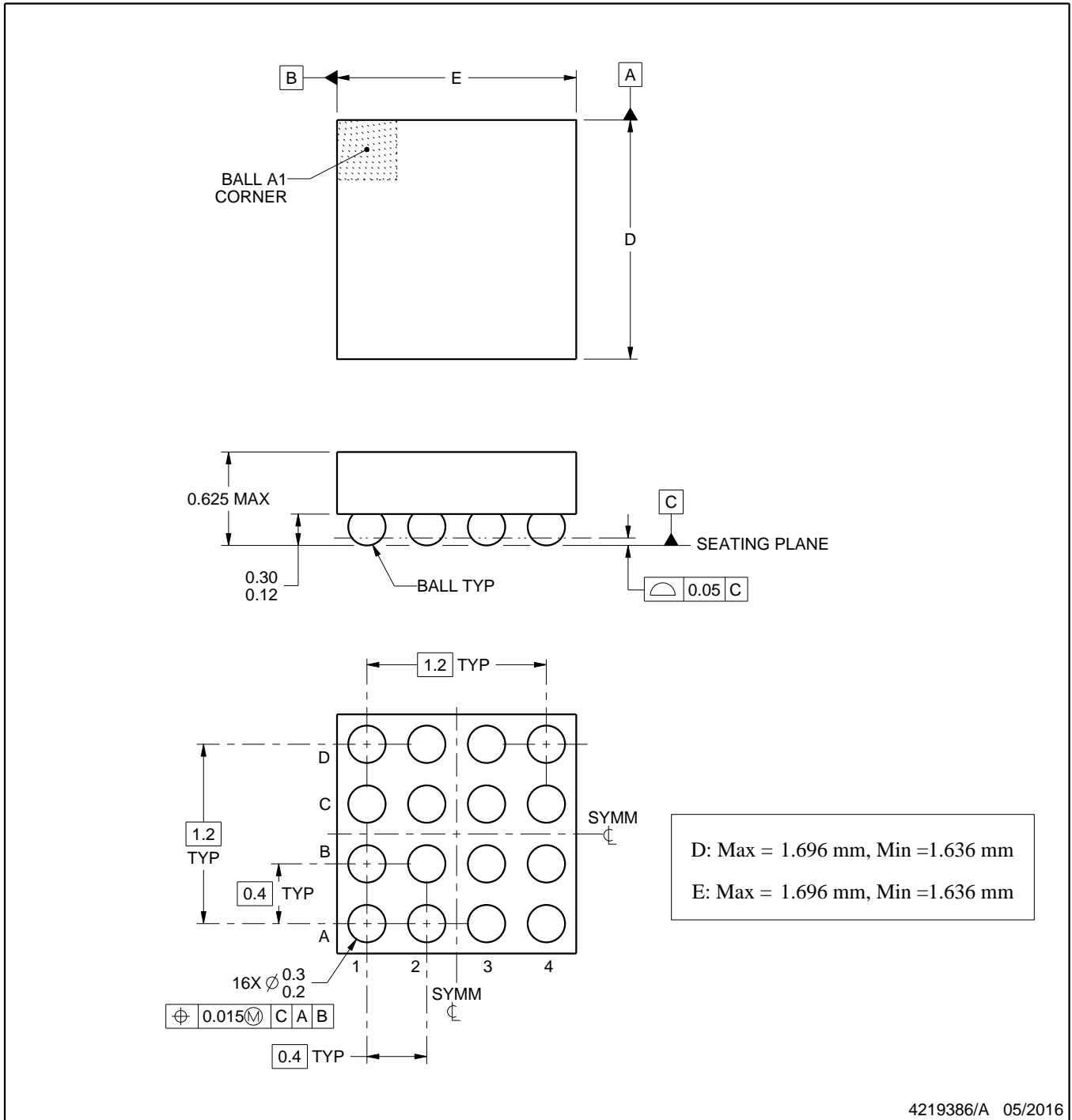

NOTES:

1. All linear dimensions are in millimeters. Any dimensions in parenthesis are for reference only. Dimensioning and tolerancing per ASME Y14.5M.
2. This drawing is subject to change without notice.

EXAMPLE BOARD LAYOUT

YFF0016

DSBGA - 0.625 mm max height

DIE SIZE BALL GRID ARRAY

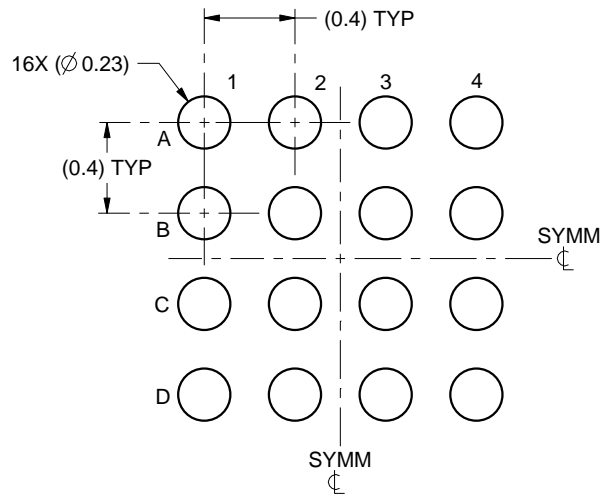

LAND PATTERN EXAMPLE
SCALE:30X

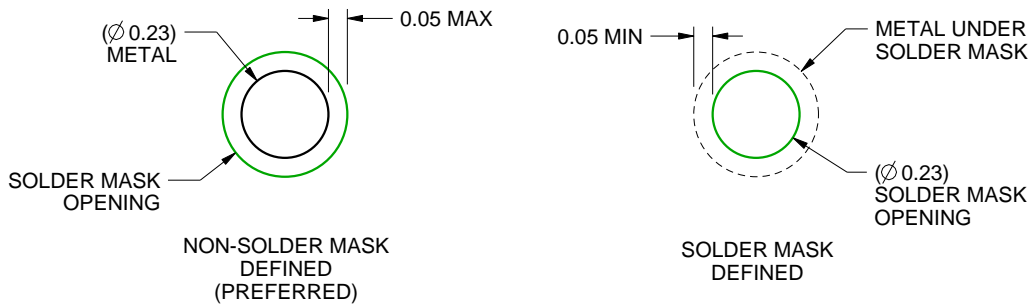

SOLDER MASK DETAILS
NOT TO SCALE

4219386/A 05/2016

NOTES: (continued)

3. Final dimensions may vary due to manufacturing tolerance considerations and also routing constraints. For more information, see Texas Instruments literature number SNVA009 (www.ti.com/lit/snva009).

EXAMPLE STENCIL DESIGN

YFF0016

DSBGA - 0.625 mm max height

DIE SIZE BALL GRID ARRAY

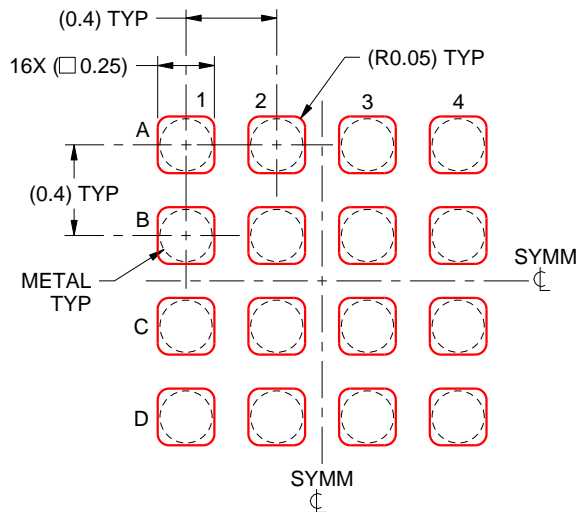

SOLDER PASTE EXAMPLE
BASED ON 0.1 mm THICK STENCIL
SCALE:30X

4219386/A 05/2016

NOTES: (continued)

4. Laser cutting apertures with trapezoidal walls and rounded corners may offer better paste release.

IMPORTANT NOTICE

Texas Instruments Incorporated (TI) reserves the right to make corrections, enhancements, improvements and other changes to its semiconductor products and services per JESD46, latest issue, and to discontinue any product or service per JESD48, latest issue. Buyers should obtain the latest relevant information before placing orders and should verify that such information is current and complete.

TI's published terms of sale for semiconductor products (<http://www.ti.com/sc/docs/stdterms.htm>) apply to the sale of packaged integrated circuit products that TI has qualified and released to market. Additional terms may apply to the use or sale of other types of TI products and services.

Reproduction of significant portions of TI information in TI data sheets is permissible only if reproduction is without alteration and is accompanied by all associated warranties, conditions, limitations, and notices. TI is not responsible or liable for such reproduced documentation. Information of third parties may be subject to additional restrictions. Resale of TI products or services with statements different from or beyond the parameters stated by TI for that product or service voids all express and any implied warranties for the associated TI product or service and is an unfair and deceptive business practice. TI is not responsible or liable for any such statements.

Buyers and others who are developing systems that incorporate TI products (collectively, "Designers") understand and agree that Designers remain responsible for using their independent analysis, evaluation and judgment in designing their applications and that Designers have full and exclusive responsibility to assure the safety of Designers' applications and compliance of their applications (and of all TI products used in or for Designers' applications) with all applicable regulations, laws and other applicable requirements. Designer represents that, with respect to their applications, Designer has all the necessary expertise to create and implement safeguards that (1) anticipate dangerous consequences of failures, (2) monitor failures and their consequences, and (3) lessen the likelihood of failures that might cause harm and take appropriate actions. Designer agrees that prior to using or distributing any applications that include TI products, Designer will thoroughly test such applications and the functionality of such TI products as used in such applications.

TI's provision of technical, application or other design advice, quality characterization, reliability data or other services or information, including, but not limited to, reference designs and materials relating to evaluation modules, (collectively, "TI Resources") are intended to assist designers who are developing applications that incorporate TI products; by downloading, accessing or using TI Resources in any way, Designer (individually or, if Designer is acting on behalf of a company, Designer's company) agrees to use any particular TI Resource solely for this purpose and subject to the terms of this Notice.

TI's provision of TI Resources does not expand or otherwise alter TI's applicable published warranties or warranty disclaimers for TI products, and no additional obligations or liabilities arise from TI providing such TI Resources. TI reserves the right to make corrections, enhancements, improvements and other changes to its TI Resources. TI has not conducted any testing other than that specifically described in the published documentation for a particular TI Resource.

Designer is authorized to use, copy and modify any individual TI Resource only in connection with the development of applications that include the TI product(s) identified in such TI Resource. NO OTHER LICENSE, EXPRESS OR IMPLIED, BY ESTOPPEL OR OTHERWISE TO ANY OTHER TI INTELLECTUAL PROPERTY RIGHT, AND NO LICENSE TO ANY TECHNOLOGY OR INTELLECTUAL PROPERTY RIGHT OF TI OR ANY THIRD PARTY IS GRANTED HEREIN, including but not limited to any patent right, copyright, mask work right, or other intellectual property right relating to any combination, machine, or process in which TI products or services are used. Information regarding or referencing third-party products or services does not constitute a license to use such products or services, or a warranty or endorsement thereof. Use of TI Resources may require a license from a third party under the patents or other intellectual property of the third party, or a license from TI under the patents or other intellectual property of TI.

TI RESOURCES ARE PROVIDED "AS IS" AND WITH ALL FAULTS. TI DISCLAIMS ALL OTHER WARRANTIES OR REPRESENTATIONS, EXPRESS OR IMPLIED, REGARDING RESOURCES OR USE THEREOF, INCLUDING BUT NOT LIMITED TO ACCURACY OR COMPLETENESS, TITLE, ANY EPIDEMIC FAILURE WARRANTY AND ANY IMPLIED WARRANTIES OF MERCHANTABILITY, FITNESS FOR A PARTICULAR PURPOSE, AND NON-INFRINGEMENT OF ANY THIRD PARTY INTELLECTUAL PROPERTY RIGHTS. TI SHALL NOT BE LIABLE FOR AND SHALL NOT DEFEND OR INDEMNIFY DESIGNER AGAINST ANY CLAIM, INCLUDING BUT NOT LIMITED TO ANY INFRINGEMENT CLAIM THAT RELATES TO OR IS BASED ON ANY COMBINATION OF PRODUCTS EVEN IF DESCRIBED IN TI RESOURCES OR OTHERWISE. IN NO EVENT SHALL TI BE LIABLE FOR ANY ACTUAL, DIRECT, SPECIAL, COLLATERAL, INDIRECT, PUNITIVE, INCIDENTAL, CONSEQUENTIAL OR EXEMPLARY DAMAGES IN CONNECTION WITH OR ARISING OUT OF TI RESOURCES OR USE THEREOF, AND REGARDLESS OF WHETHER TI HAS BEEN ADVISED OF THE POSSIBILITY OF SUCH DAMAGES.

Unless TI has explicitly designated an individual product as meeting the requirements of a particular industry standard (e.g., ISO/TS 16949 and ISO 26262), TI is not responsible for any failure to meet such industry standard requirements.

Where TI specifically promotes products as facilitating functional safety or as compliant with industry functional safety standards, such products are intended to help enable customers to design and create their own applications that meet applicable functional safety standards and requirements. Using products in an application does not by itself establish any safety features in the application. Designers must ensure compliance with safety-related requirements and standards applicable to their applications. Designer may not use any TI products in life-critical medical equipment unless authorized officers of the parties have executed a special contract specifically governing such use. Life-critical medical equipment is medical equipment where failure of such equipment would cause serious bodily injury or death (e.g., life support, pacemakers, defibrillators, heart pumps, neurostimulators, and implantables). Such equipment includes, without limitation, all medical devices identified by the U.S. Food and Drug Administration as Class III devices and equivalent classifications outside the U.S.

TI may expressly designate certain products as completing a particular qualification (e.g., Q100, Military Grade, or Enhanced Product). Designers agree that it has the necessary expertise to select the product with the appropriate qualification designation for their applications and that proper product selection is at Designers' own risk. Designers are solely responsible for compliance with all legal and regulatory requirements in connection with such selection.

Designer will fully indemnify TI and its representatives against any damages, costs, losses, and/or liabilities arising out of Designer's non-compliance with the terms and provisions of this Notice.