

LM3262 适用于 RF 功率放大器的具有自动旁路功能的 6MHz、800mA 微型可调降压 DC-DC 转换器

1 特性

- 由单节锂离子电池供电运行 (2.5V 至 5.5V)
- 6MHz (典型值) 脉宽调制 (PWM) 开关频率
- 可调节输出电压 (0.4V 至 3.6V)
- 800mA 最大负载性能 (旁路模式下高达 1A)
- 高效率 (3.8 V_{IN}, 3.4 V_{OUT}, 500mA 时的典型效率为 93%)
- 自动 ECO/PWM/BP 模式切换
- 电流过载和热过载保护
- 多功能 VCON 引脚 (无需使用独立 BPEN 控制)
- 软启动功能
- 小型片式电感, 外壳尺寸为 0805 (2012)
- 休眠模式下的 I_Q 为 25μA (典型值)
- 2V 步长的上升时间和下降时间为 5μs (典型值)
- 9 引脚芯片尺寸球状引脚栅格阵列 (DSBGA) 封装

2 应用

- 高速上行分组接入 (HSUPA), 采用长期演进 (LTE) 的手机
- 时分同步码分多址 (TD-SCDMA) 和分时长期演进 (TD-LTE)
- 手持无线电设备
- RF PC 卡
- 电池供电类 RF 器件
- 由 USB 供电的便携式应用

3 说明

LM3262 是一款 DC-DC 转换器, 针对由单节锂离子电池供电的 RF 功率放大器 (PA) 进行了优化。此外, 该器件也可用于其他应用, 例如由 USB 供电的便携式应用。该器件可将介于 2.5V-5.5V 范围内的输入电压降转换至 0.4V-3.6V 的可调输出电压。输出电压使用 VCON 模拟输入进行设置, 可提高 RF 级的 PA 效率。

LM3262 具有 5 种工作模式。在脉宽调制 (PWM) 模式下, 该器件以 6MHz (典型值) 固定频率运行, 因此可在驱动低到中等负载时最大限度地抑制 RF 干扰。轻负载时, 器件自动进入 ECO 模式并以减少的开关频率运行。在 ECO 模式下, 静态电流被减少并延长了电池使用寿命。该器件在关断模式下处于关闭状态, 电池流耗降至 0.1μA (典型值)。在低电量状态下, 旁路模式可将压降降至 50mV (典型值) 以下。此外, 该器件还具备休眠模式。

LM3262 采用 9 引脚无引线 DSBGA 封装。高开关频率 (6MHz) 允许仅使用三个微型表面贴装组件, 即一个电感和两个陶瓷电容。

器件信息⁽¹⁾

器件型号	封装	封装尺寸 (最大值)
LM3262	DSBGA (9)	1.51mm x 1.385mm

(1) 要了解所有可用封装, 请见数据表末尾的可订购产品附录。

典型应用电路

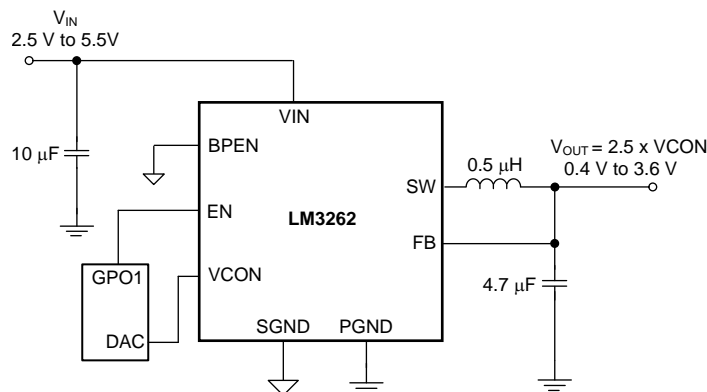

目录

1	特性	1	7.4	Device Functional Modes.....	14
2	应用	1	8	Application and Implementation	16
3	说明	1	8.1	Application Information.....	16
4	修订历史记录	2	8.2	Typical Application	16
5	Pin Configuration and Functions	3	9	Power Supply Recommendations	19
6	Specifications	4	10	Layout	20
6.1	Absolute Maximum Ratings	4	10.1	Layout Guidelines	20
6.2	ESD Ratings.....	4	10.2	Layout Examples.....	21
6.3	Recommended Operating Conditions.....	4	10.3	DSBGA Assembly and Use	25
6.4	Thermal Information	4	11	器件和文档支持	26
6.5	Electrical Characteristics	5	11.1	器件支持	26
6.6	System Characteristics	6	11.2	文档支持	26
6.7	Timing Requirements	6	11.3	社区资源	26
6.8	Typical Characteristics	7	11.4	商标	26
7	Detailed Description	11	11.5	静电放电警告	26
7.1	Overview	11	11.6	Glossary	26
7.2	Functional Block Diagram	12	12	机械、封装和可订购信息	26
7.3	Feature Description.....	12			

4 修订历史记录

注：之前版本的页码可能与当前版本有所不同。

Changes from Revision N (March 2013) to Revision O

Page

- 已添加 器件信息和引脚配置和功能部分，ESD 额定值和热性能信息表，特性 描述，器件功能模式，应用和实施，电源相关建议，布局，器件和文档支持以及机械、封装和可订购信息部分 **1**

5 Pin Configuration and Functions

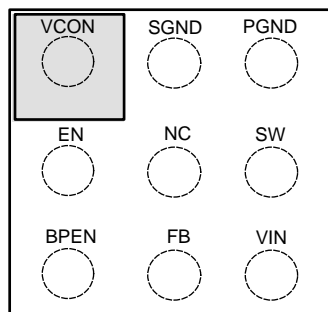
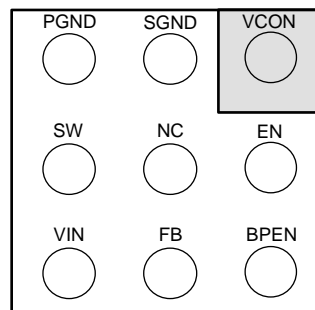
**YFQ Package
9-Pin DSBGA
Top View**

**YFQ Package
9-Pin DSBGA
Bottom View**

Pin Functions

PIN		TYPE	DESCRIPTION
NO.	NAME		
A1	VCON	Analog	Voltage control analog input. VCON controls V_{OUT} in PWM and ECO modes. VCON may also be used to force the device into sleep mode by setting $VCON < 80\text{ mV}$ or into bypass condition by setting $VCON > 1.5\text{ V}$.
A2	SGND	Ground	Signal ground for analog and control circuitry.
A3	PGND	Ground	Power ground for the Power MOSFETs and gate drive circuitry
B1	EN	Digital/Input	Enable Input. Set this digital input high for normal operation. For shutdown, set low. Do not leave EN pin floating.
B2	NC	—	Do not connect to PGND directly — Internally connected to SGND.
B3	SW	Analog	Switching node connection to the internal PFET switch and NFET synchronous rectifier. Connect to an inductor with a saturation current rating that exceeds the maximum switch peak current limit specification of the LM3262.
C1	BPEN	Input	Bypass enable input. Set this digital input high to force bypass operation. For normal operation with automatic bypass, set low or connect to ground. Do not leave this pin floating.
C2	FB	Analog	Feedback analog input and bypass FET output. Connect to the output at the output filter capacitor.
C3	VIN	Input	Voltage supply input for SMPS converter.

6 Specifications

6.1 Absolute Maximum Ratings

over operating free-air temperature range (unless otherwise noted)⁽¹⁾⁽²⁾

	MIN	MAX	UNIT
V _{IN} to SGND	-0.2	6	V
PGND to SGND	-0.2	0.2	V
EN, VCON, BPEN	(SGND - 0.2)	(V _{IN} + 0.2)	V
FB, SW	(PGND - 0.2)	(V _{IN} + 0.2)	V
Continuous power dissipation ⁽³⁾	Internally limited		
Junction temperature, T _{J-MAX}		150	°C
Maximum lead temperature (soldering, 10 sec)		260	°C
Storage temperature, T _{stg}	-65	150	°C

- (1) Stresses beyond those listed under *Absolute Maximum Ratings* may cause permanent damage to the device. These are stress ratings only, which do not imply functional operation of the device at these or any other conditions beyond those indicated under *Recommended Operating Conditions*. Exposure to absolute-maximum-rated conditions for extended periods may affect device reliability.
- (2) All voltages are with respect to the potential at the GND pins.
- (3) Internal thermal shutdown circuitry protects the device from permanent damage. Thermal shutdown engages at T_J = 150°C (typical) and disengages at T_J = 130°C (typical).

6.2 ESD Ratings

		VALUE	UNIT
V _(ESD) Electrostatic discharge	Human-body model (HBM), per ANSI/ESDA/JEDEC JS-001 ⁽¹⁾	±2000	V
	Charged-device model (CDM), per JEDEC specification JESD22-C101 ⁽²⁾	±1250	

- (1) JEDEC document JEP155 states that 500-V HBM allows safe manufacturing with a standard ESD control process.
- (2) JEDEC document JEP157 states that 250-V CDM allows safe manufacturing with a standard ESD control process.

6.3 Recommended Operating Conditions

over operating free-air temperature range (unless otherwise noted)⁽¹⁾

		MIN	MAX	UNIT
Input voltage, V _{IN}		2.5	5.5	V
Recommended load current	PWM mode	0	800	mA
	Bypass mode	0	1000	mA
Junction temperature, T _J		-30	125	°C
Ambient temperature, T _A ⁽²⁾		-30	90	°C

- (1) All voltages are with respect to the potential at the GND pins
- (2) In applications where high-power dissipation and/or poor package thermal resistance is present, the maximum ambient temperature may have to be de-rated. Maximum ambient temperature (T_{A-MAX}) is dependent on the maximum operating junction temperature (T_{J-MAX-OP} = 125°C), the maximum power dissipation of the device in the application (P_{D-MAX}), and the junction-to ambient thermal resistance of the part/package in the application (R_{θJA}), as given by the following equation: T_{A-MAX} = T_{J-MAX-OP} - (R_{θJA} × P_{D-MAX}).

6.4 Thermal Information

THERMAL METRIC ⁽¹⁾		LM3262	UNIT
		YFQ (DSBGA)	
		9 PINS	
R _{θJA}	Junction-to-ambient thermal resistance	85	°C/W

- (1) For more information about traditional and new thermal metrics, see the *Semiconductor and IC Package Thermal Metrics* application report, [SPRA953](#).

6.5 Electrical Characteristics

Unless otherwise noted, all specifications apply to the [典型应用电路](#) with: $V_{IN} = EN = 3.6\text{ V}$ and $BPEN = NC = 0\text{ V}$. All typical (TYP) limits apply for $T_A = T_J = 25^\circ\text{C}$, and all minimum (MIN) and maximum (MAX) apply over the full operating ambient temperature range ($-30^\circ\text{C} \leq T_A = T_J \leq +90^\circ\text{C}$), unless otherwise specified. ⁽¹⁾⁽²⁾⁽³⁾

PARAMETER	TEST CONDITIONS	MIN	TYP	MAX	UNIT
$V_{FB, MIN}$	Feedback voltage at minimum setting PWM mode, $V_{CON} = 0.16\text{ V}$ ⁽⁴⁾	0.38	0.4	0.42	V
$V_{FB, MAX}$	Feedback voltage at maximum setting PWM mode, $V_{CON} = 1.44\text{ V}$, $V_{IN} = 4\text{ V}$	3.55	3.6	3.65	V
I_{SHDN}	Shutdown supply current $EN = SW = V_{CON} = FB = BPEN = NC = 0\text{ V}$ ⁽⁵⁾		0.1	1	μA
I_{Q_PWM}	PWM mode quiescent current PWM mode, No switching $V_{CON} = 0.13\text{ V}$, $FB = 1\text{ V}$ ⁽⁶⁾		650	795	μA
I_{Q_SLEEP}	Low-power sleep mode $EN = V_{IN}$, $BPEN = NC = 0\text{ V}$, $SW = \text{tri state}$ $V_{CON} < 0.8\text{ V}$, $FB = 2.05\text{ V}$ ⁽⁷⁾		25		μA
I_{Q_ECO}	ECO mode quiescent current ECO mode, No switching $V_{CON} = 0.8\text{ V}$, $FB = 2.05\text{ V}$ ⁽⁶⁾		60		μA
$I_{LIM,P}$	PFET switch peak current limit See ⁽⁸⁾	1300	1450	1600	mA
$I_{LIM, BP}$	BPFET switch peak current limit $V_{FB} = V_{IN} - 1\text{ V}$	310	400		mA
f_{OSC}	Internal oscillator frequency	5.7	6	6.3	MHz
V_{IH}	EN, BPEN logic high input threshold	1.2			V
V_{IL}	EN, BPEN logic low input threshold			0.4	V
Gain	V_{CON} to V_{OUT} gain $0.16\text{ V} \leq V_{CON} \leq 1.44\text{ V}$ ⁽⁹⁾		2.5		V/V
I_{VCON}	V_{CON} pin leakage current $V_{CON} = 1\text{ V}$	-1		1	μA
$V_{BP, NEG}$	Auto bypass detection negative threshold $V_{CON} = 1.2\text{ V}$ ($V_{OUT-SET} = 3\text{ V}$) $V_{IN} = 3.2\text{ V}$, $R_L = 6\ \Omega$ ($I_{OUT} = 500\text{ mA}$) ⁽¹⁰⁾	165	200	235	mV
$V_{BP, POS}$	Auto bypass detection positive threshold $V_{CON} = 1.2\text{ V}$ ($V_{OUT-SET} = 3\text{ V}$) $V_{IN} = 3.25\text{ V}$, $R_L = 6\ \Omega$ ($I_{OUT} = 500\text{ mA}$) ⁽¹¹⁾	215	250	285	mV
$I_{BP, SLEW}$	$BPEN = \text{High}$, Forced bypass		1600		mA

- (1) All voltages are with respect to the potential at the GND pins.
- (2) Minimum and maximum limits are specified by design, test, or statistical analysis.
- (3) The parameters in the electrical characteristics table are tested under open loop conditions at $V_{IN} = 3.6\text{ V}$ unless otherwise specified. For performance over the input voltage range and closed-loop results, refer to [Typical Characteristics](#).
- (4) All 0.4-V V_{OUT} specifications are at steady-state only.
- (5) Shutdown current includes leakage current of PFET.
- (6) I_Q specified here is when the device is not switching. For operating input current at no load, refer to [Typical Characteristics](#).
- (7) FB has 200 k Ω to SGND.
- (8) Current limit is built-in, fixed, and not adjustable.
- (9) Care should be taken to keep the V_{CON} pin voltage less than the V_{IN} pin voltage as this can place the device into a manufacturing test mode.
- (10) Entering bypass mode, V_{IN} is compared to the programmed output voltage ($2.5 \times V_{CON}$). When $V_{IN} - (2.5 \times V_{CON})$ falls below $V_{BP, NEG}$ longer than $T_{BP, NEG}$, the bypass FET turns on, and the switching FET turns on.
- (11) Bypass mode is exited when $V_{IN} - (2.5 \times V_{CON})$ exceeds $V_{BP, POS}$ longer than $T_{BP, POS}$, and PWM mode resumes. The hysteresis for the bypass detection threshold $V_{BP, POS} - V_{BP, NEG}$ is always positive and is approximately 50 mV.

6.6 System Characteristics

The following parameters are specified by design and verifications providing the component values in the [典型应用电路](#) are used. *These parameters are not verified by production testing.* Minimum (MIN) and maximum (MAX) values are specified over the ambient temperature range $T_A = -30^\circ\text{C} \leq T_A \leq +90^\circ\text{C}$ and over the V_{IN} range = 2.5 V to 5.5 V, unless otherwise specified; $L = 0.5 \mu\text{H}$, $\text{DCR} = 50 \text{ m}\Omega$, $C_{IN} = 10 \mu\text{F}$, 6.3 V, 0402 (1005), $C_{OUT} = 4.7 \mu\text{F}$, 6.3 V, 0402 (1005). For bench evaluation, see ⁽¹⁾.

PARAMETER		TEST CONDITIONS	MIN	TYP	MAX	UNIT
D	Maximum duty cycle	MODE = LOW	100%			
I_{OUT}	Maximum output current capability	$2.5 \text{ V} \leq V_{IN} \leq 5.5 \text{ V}$ $2.5 \times V_{CON} \leq V_{IN} - 285 \text{ mV}$	800			mA
		$2.5 \text{ V} \leq V_{IN} \leq 5.5 \text{ V}$ $2.5 \times V_{CON} \leq V_{IN} - 165 \text{ mV}$, bypass mode	1000			
V_{OUT} linearity	$V_{CON} = 0.16 \text{ V}$ to 1.44 V	$0 \text{ mA} \leq I_{OUT} \leq 800 \text{ mA}^{(2)}$	-3%		3%	mV
			-50		50	
η	Efficiency	$V_{IN} = 3.8 \text{ V}$, $V_{OUT} = 0.8 \text{ V}$ $I_{OUT} = 10 \text{ mA}$, ECO mode	71%			
		$V_{IN} = 3.8 \text{ V}$, $V_{OUT} = 2.5 \text{ V}$ $I_{OUT} = 200 \text{ mA}$, PWM mode	92%			
		$V_{IN} = 3.8 \text{ V}$, $V_{OUT} = 3.4 \text{ V}$ $I_{OUT} = 500 \text{ mA}$, PWM mode	93%			
LINE_tr	Line transient response	$V_{IN} = 3.6 \text{ V}$ to 4.2 V , $T_R = T_F = 10 \mu\text{s}$, $I_{OUT} = 100 \text{ mA}$, $V_{OUT} = 0.8 \text{ V}$	50			mVpk
LOAD_tr	Load transient response	$V_{IN} = 3.1/3.6/4.5 \text{ V}$, $V_{OUT} = 0.8 \text{ V}$ $I_{OUT} = 50 \text{ mA}$ to 150 mA $T_R = T_F = 10 \mu\text{s}$,	50			mVpk

- (1) When the LM3262 device is being evaluated apart from a normal system design or on a PCB other than the TI LM3262 evaluation module, user should ensure that a 50- μF to 100- μF ceramic input capacitor is added to the PCB to keep input voltage from sagging during rapid load transitions.
- (2) Linearity limits are $\pm 3\%$ or $\pm 50 \text{ mV}$, whichever is larger. V_{OUT} is monotonic in nature with respect to V_{CON} input.

6.7 Timing Requirements

		MIN	NOM	MAX	UNIT
T_{VCON_TR}	V_{OUT} rise time V_{CON} change to 90%; $V_{IN} = 3.7 \text{ V}$, $V_{OUT} = 1.4 \text{ V}$ to 3.4 V $0.1 \mu\text{s} < V_{CON_TR} < 1 \mu\text{s}$, $R_L = 12 \Omega$	5			μs
	V_{OUT} fall time V_{CON} change to 10%; $V_{IN} = 3.7 \text{ V}$, $V_{OUT} = 3.4 \text{ V}$ to 1.4 V $0.1 \mu\text{s} < V_{CON_TR} < 1 \mu\text{s}$, $R_L = 12 \Omega$	5			μs
T_{ON}	Turnon time (time for output to reach 95% final value after Enable low-to-high transition) EN = low-to-high, $V_{IN} = 4.2 \text{ V}$, $V_{OUT} = 3.4 \text{ V}$ $I_{OUT} \leq 1 \text{ mA}$, $C_{OUT} = 4.7 \mu\text{F}$	50			μs
T_{BP_NEG}	Auto bypass detect negative threshold delay time ⁽¹⁾	10			μs
T_{BP_POS}	Auto bypass detect positive threshold delay time ⁽²⁾	0.1			μs

- (1) Entering bypass mode, V_{IN} is compared to the programmed output voltage ($2.5 \times V_{CON}$). When $V_{IN} - (2.5 \times V_{CON})$ falls below V_{BP_NEG} longer than T_{BP_NEG} , the bypass FET turns on, and the switching FET turns on.
- (2) Bypass mode is exited when $V_{IN} - (2.5 \times V_{CON})$ exceeds V_{BP_POS} longer than T_{BP_POS} , and PWM mode resumes. The hysteresis for the bypass detection threshold $V_{BP_POS} - V_{BP_NEG}$ is always positive and will be approximately 50 mV.

6.8 Typical Characteristics

$V_{IN} = EN = 3.6\text{ V}$, $L = 0.5\ \mu\text{H}$, $C_{IN} = 10\ \mu\text{F}$, $C_{OUT} = 4.7\ \mu\text{F}$ and $T_A = 25^\circ\text{C}$, unless otherwise noted.

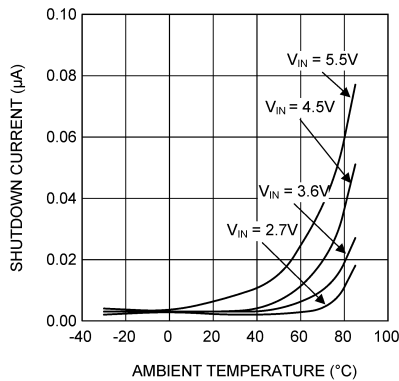

SW = VCON = EN = BPEN = 0V

Figure 1. Shutdown Current vs Temperature

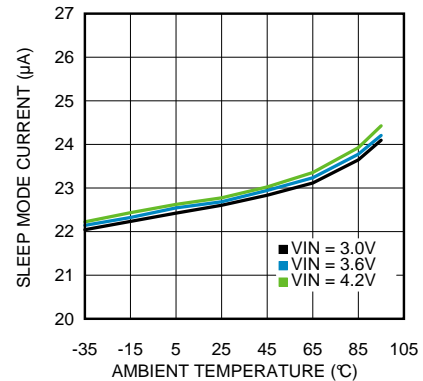

VCON < 80 mV

EN = VIN

BPEN = 0

Figure 2. Sleep Mode Current vs Temperature

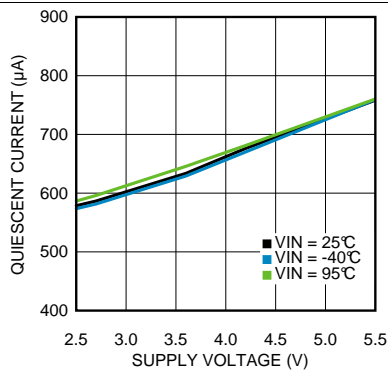

No Switching

FB = 1 V

VCON = 0.13 V

Figure 3. Quiescent Current vs Supply Voltage

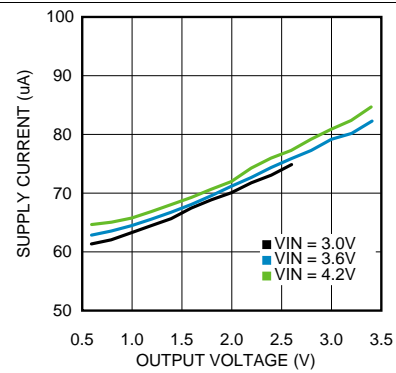

Closed Loop

Switching

No load

Figure 4. ECO Mode Supply Current vs Output Voltage

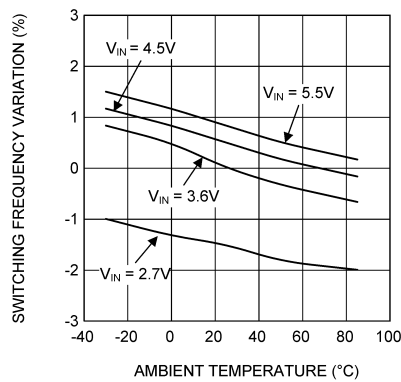

$V_{OUT} = 2\text{ V}$

$I_{OUT} = 200\text{ mA}$

Figure 5. Switching Frequency vs Temperature

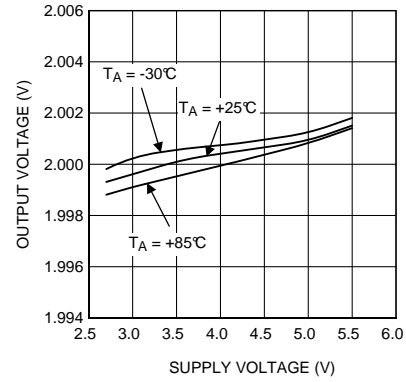

$V_{OUT} = 2\text{ V}$

$R_{LOAD} = 10\ \Omega$

Figure 6. Output Voltage vs Supply Voltage

Typical Characteristics (continued)

$V_{IN} = EN = 3.6\text{ V}$, $L = 0.5\ \mu\text{H}$, $C_{IN} = 10\ \mu\text{F}$, $C_{OUT} = 4.7\ \mu\text{F}$ and $T_A = 25^\circ\text{C}$, unless otherwise noted.

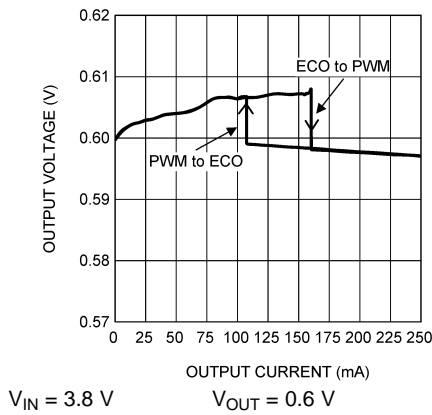

Figure 7. Output Voltage vs Output Current

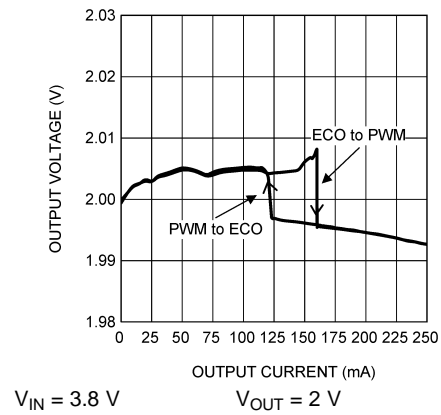

Figure 8. Output Voltage vs Output Current

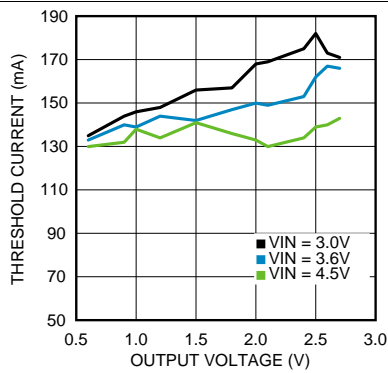

Figure 9. ECO-PWM Mode Threshold Current vs Output Voltage

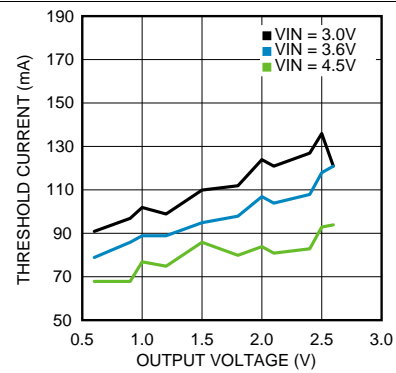

Figure 10. PWM-ECO Mode Threshold Current vs Output Voltage

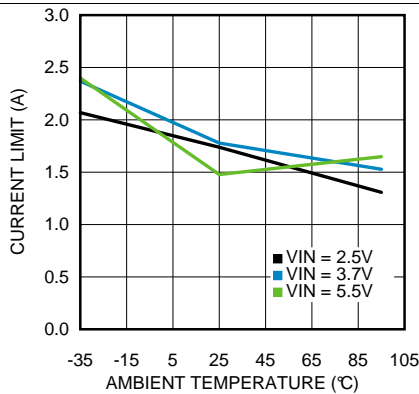

Figure 11. Closed-Loop Current Limit vs Temperature

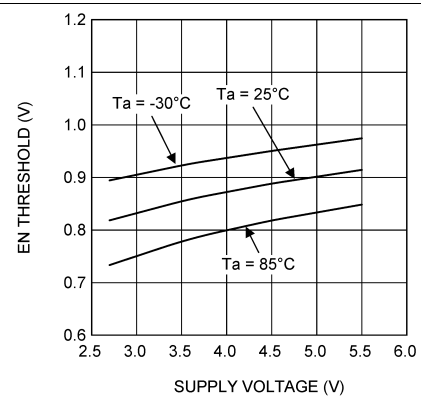

Figure 12. EN High Threshold vs Supply Voltage

Typical Characteristics (continued)

$V_{IN} = EN = 3.6\text{ V}$, $L = 0.5\ \mu\text{H}$, $C_{IN} = 10\ \mu\text{F}$, $C_{OUT} = 4.7\ \mu\text{F}$ and $T_A = 25^\circ\text{C}$, unless otherwise noted.

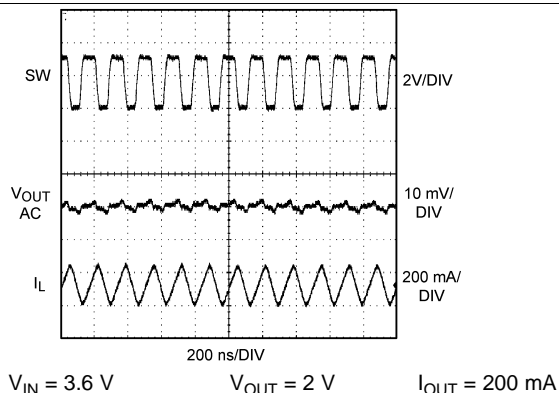

Figure 13. Output Voltage Ripple in PWM Mode

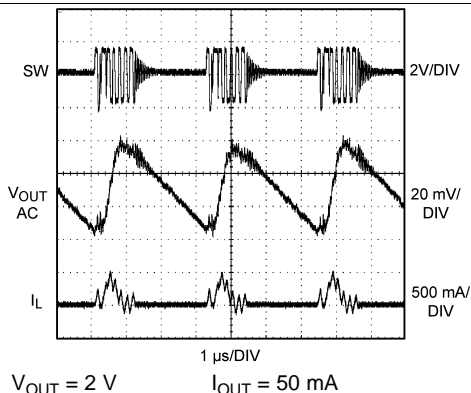

Figure 14. Output Voltage Ripple in ECO Mode

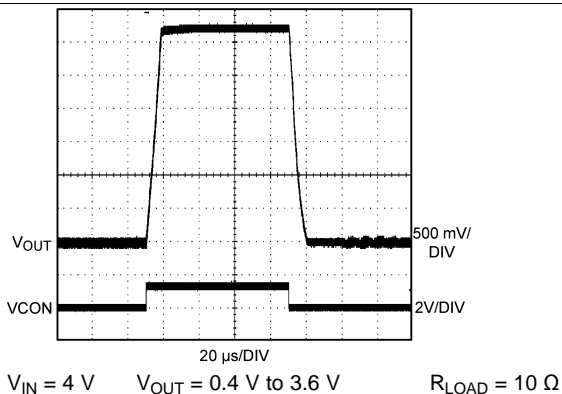

Figure 15. VCON Transient Response

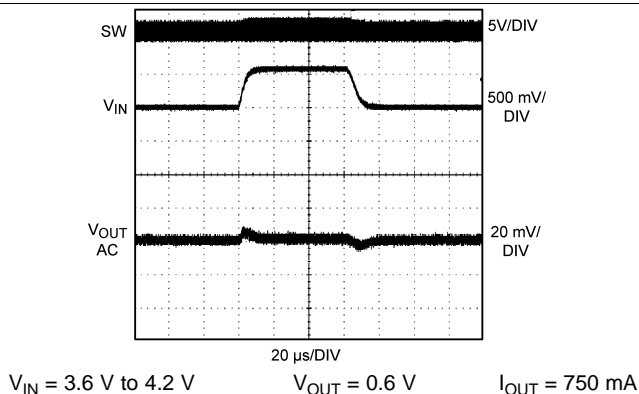

Figure 16. Line Transient Response

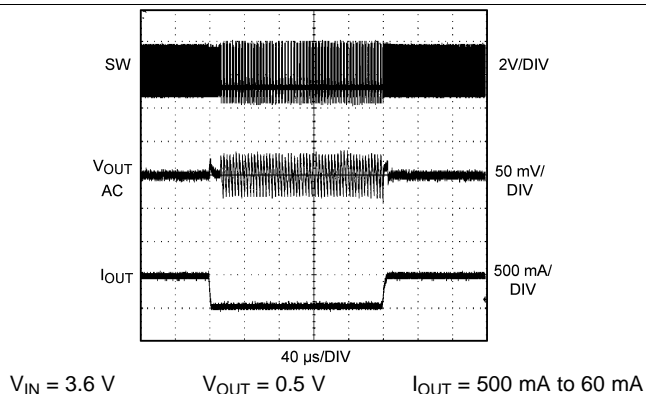

Figure 17. Load Transient Response

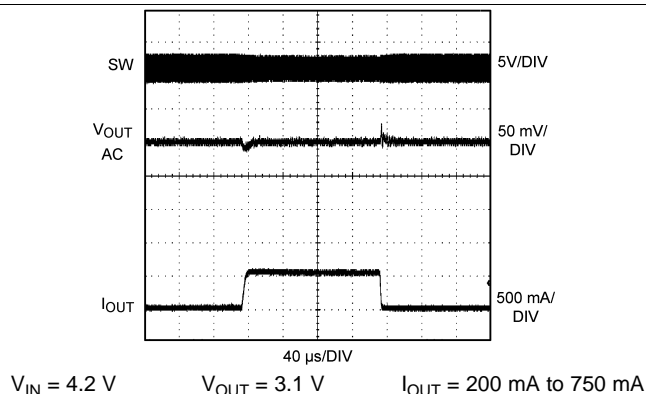
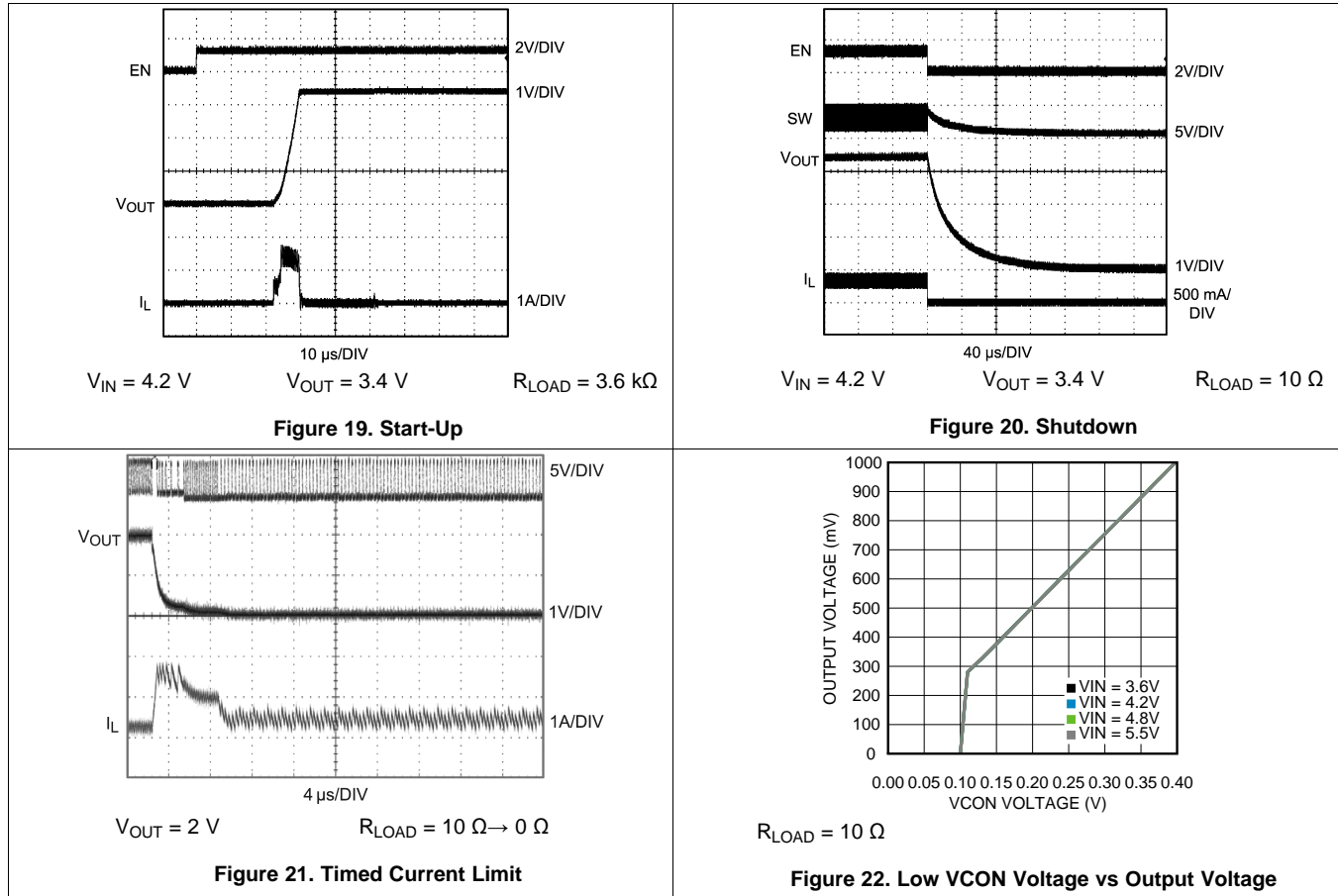

Figure 18. Load Transient Response

Typical Characteristics (continued)

$V_{IN} = EN = 3.6\text{ V}$, $L = 0.5\ \mu\text{H}$, $C_{IN} = 10\ \mu\text{F}$, $C_{OUT} = 4.7\ \mu\text{F}$ and $T_A = 25^\circ\text{C}$, unless otherwise noted.



7 Detailed Description

7.1 Overview

The LM3262 is a simple, step-down DC-DC converter optimized for powering RF power amplifiers (PAs) in mobile phones, portable communicators, and similar battery powered RF devices. It is designed to allow the RF PA to operate at maximum efficiency over a wide range of power levels from a single li-ion battery cell. The device is based on a voltage-mode buck architecture, with synchronous rectification for high efficiency. It is designed for a maximum load capability of 800 mA in PWM mode. Maximum load range may vary from this depending on input voltage, output voltage, and the inductor chosen.

There are five modes of operation depending on the current required: pulse width modulation (PWM), ECOmomy (ECO), bypass (BP), sleep, and shutdown. (See [Table 1](#).) The LM3262 operates in PWM mode at higher load current conditions. Lighter loads cause the device to automatically switch into ECO mode. Shutdown mode turns the device off and reduces battery consumption to 0.1 μ A (typical).

DC PWM mode output voltage precision is $\pm 2\%$ for 3.6 V_{OUT} . Efficiency is approximately 93% (typical) for a 500-mA load with 3.4-V output, 3.8-V input. The output voltage is dynamically programmable from 0.4 V to 3.6 V by adjusting the voltage on the control pin (VCON) without the need for external feedback resistors. This ensures longer battery life by being able to change the PA supply voltage dynamically depending on its transmitting power.

Additional features include current overload protection and thermal overload shutdown.

The LM3262 is constructed using a chip-scale, 9-pin DSBGA package. This package offers the smallest possible size for space-critical applications, such as cell phones, where board area is an important design consideration. Use of a high switching frequency (6 MHz, typical) reduces the size of external components. As shown in the [典型应用电路](#), only three external power components are required for implementation. Use of a DSBGA package requires special design considerations for implementation. (See [DSBGA Assembly and Use](#).) The fine bump-pitch of the DSBGA package requires careful board design and precision assembly equipment. Use of this package is best suited for opaque-case applications, where its edges are not subject to high-intensity ambient red or infrared light. Also, the system controller must set EN low during power-up and other low supply voltage conditions. (See [Shutdown Mode](#).)

7.2 Functional Block Diagram

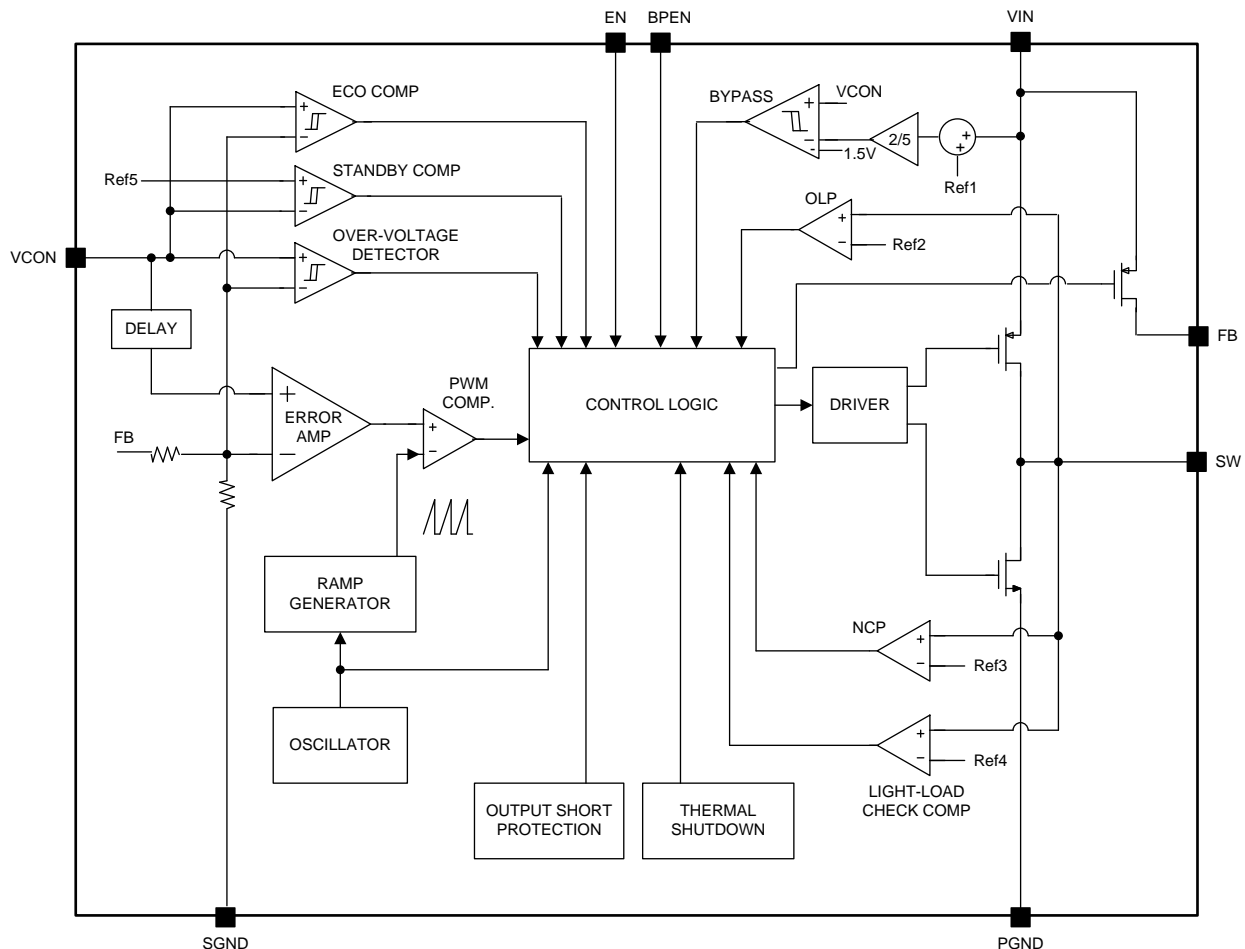

7.3 Feature Description

7.3.1 Circuit Operation

Referring to the [Functional Block Diagram](#), the LM3262 operates as follows. During the first part of each switching cycle, the control block in the LM3262 turns on the internal top-side PFET switch. This allows current to flow from the input through the inductor to the output filter capacitor and load. The inductor limits the current to a ramp with a slope of around $(V_{IN} - V_{OUT}) / L$, by storing energy in a magnetic field. During the second part of each cycle, the controller turns the PFET switch off, blocking current flow from the input, and then turns the bottom-side NFET synchronous rectifier on. In response, the magnetic field of the inductor collapses, generating a voltage that forces current from ground through the synchronous rectifier to the output filter capacitor and load. As the stored energy is transferred back into the circuit and depleted, the inductor current ramps down with a slope around V_{OUT} / L . The output filter capacitor stores charge when the inductor current is high and releases it when low, smoothing the voltage across the load.

The output voltage is regulated by modulating the PFET switch on time to control the average current sent to the load. The effect is identical to sending a duty-cycle modulated rectangular wave formed by the switch and synchronous rectifier at SW to a low-pass filter formed by the inductor and output filter capacitor. The output voltage is equal to the average voltage at the SW pin.

Feature Description (continued)

7.3.2 Internal Synchronous Rectification

While in PWM mode, the LM3262 uses an internal NFET as a synchronous rectifier to reduce rectifier forward voltage drop and associated power loss. Synchronous rectification provides a significant improvement in efficiency whenever the output voltage is relatively low compared to the voltage drop across an ordinary rectifier diode.

With medium and heavy loads, the NFET synchronous rectifier is turned on during the inductor current down slope in the second part of each cycle. The synchronous rectifier is turned off prior to the next cycle. The NFET is designed to conduct through its intrinsic body diode during transient intervals before it turns on, eliminating the need for an external diode.

7.3.3 Current Limiting

The current limit feature allows the LM3262 to protect itself and external components during overload conditions. In PWM mode, the cycle-by-cycle current limit is a 1450 mA (typical). If an excessive load pulls the output voltage down to less than 0.3 V (typical), the NFET synchronous rectifier is disabled, and the current limit is reduced to 530 mA (typical). Moreover, when the output voltage becomes less than 0.15 V (typical), the switching frequency will decrease to 3 MHz, thereby preventing excess current and thermal stress.

7.3.4 Dynamically Adjustable Output Voltage

The LM3262 features dynamically adjustable output voltage to eliminate the need for external feedback resistors by controlling this voltage using the analog VCON pin. The input impedance of this pin can be approximated by a series 50-K Ω resistor and 10-pF capacitor. The output can be set from 0.4 V to 3.6 V by changing the voltage on the analog VCON pin. This feature is useful in PA applications where peak power is needed only when the handset is far away from the base station or when data is being transmitted. In other instances the transmitting power can be reduced. Hence the supply voltage to the PA can be reduced, promoting longer battery life. See [Setting The Output Voltage](#) for further details. The LM3262 moves into pulse-skipping mode when duty cycle is over approximately 92% or less than approximately 15%, and the output voltage ripple increases slightly.

7.3.5 Thermal Overload Protection

The LM3262 has a thermal overload protection function that operates to protect itself from short-term misuse and overload conditions. When the junction temperature exceeds around 150°C, the device inhibits operation. Both the PFET and the NFET are turned off. When the temperature drops below 125°C, normal operation resumes. Prolonged operation in thermal overload conditions may damage the device and is considered bad practice.

7.3.6 Soft Start

The LM3262 has a soft-start circuit that limits in-rush current during start-up. During start-up, the switch current limit is increased in steps. Soft start is activated if EN goes from low to high after V_{IN} reaches 2.5 V.

7.4 Device Functional Modes

7.4.1 PWM Mode Operation

While in PWM mode operation, the converter operates as a voltage-mode controller with input voltage feed forward. This allows the converter to achieve excellent load and line regulation. The DC gain of the power stage is proportional to the input voltage. To eliminate this dependence, feed forward inversely proportional to the input voltage is introduced. While in PWM mode, the output voltage is regulated by switching at a constant frequency, then modulating the energy per cycle to control power to the load. At the beginning of each clock cycle the PFET switch is turned on, and the inductor current ramps up until the comparator trips and the control logic turns off the switch. The current-limit comparator can also turn off the switch if the current limit of the PFET is exceeded — in this case, the NFET switch is turned on, and the inductor current ramps down. The next cycle is initiated by the clock turning off the NFET and turning on the PFET.

7.4.2 Bypass Mode Operation

The LM3262 contains an internal BPFET switch for bypassing the PWM DC-DC converter during bypass mode. In bypass mode, this BPFET is turned on to power the PA directly from the battery for maximum RF output power. When the device operates in the bypass mode, the output voltage is the input voltage less the voltage drop across the resistance of the BPFET in parallel with the PFET plus switch inductor. Bypass mode is more efficient than operating in PWM mode at 100% duty cycle because the combined resistance is significantly less than the series resistance of the PWM PFET and inductor. This translates into higher voltage available on the output in bypass mode, for a given battery voltage. The device can be forced into bypass mode by setting the BPEN pin high or by driving the VCON control pin voltage higher than 1.5 V. This is called forced bypass mode, and it remains in bypass mode until the BPEN pin goes low or VCON pin drops below 1.5 V. Alternatively, the device can go into bypass mode automatically. This is called auto-bypass mode or automatic bypass mode. The bypass switch turns on when the difference between the input voltage and programmed output voltage is less than 200 mV (typical) for longer than 10 μ s (typical). The bypass switch turns off when the input voltage is higher than the programmed output voltage by 250 mV (typical) for longer than 0.1 μ s (typical). This method is very system resource friendly in that the bypass PFET is turned on automatically when the input voltage gets close to the output voltage, a typical scenario of a discharging battery. It is also turned off automatically when the input voltage rises, a typical scenario when connecting a charger. When the device is in SLEEP mode (VCON < 80 mV), BPEN is *don't care*.

7.4.3 ECO Mode Operation

At very light loads (50 mA to 100 mA), the LM3262 enters ECO mode operation with reduced switching frequency and supply current to maintain high efficiency. During ECO mode operation, the LM3262 positions the output voltage slightly higher (7 mV typical) than the normal output voltage during PWM mode operation, allowing additional headroom for voltage drop during a load transient from light-to-heavy load.

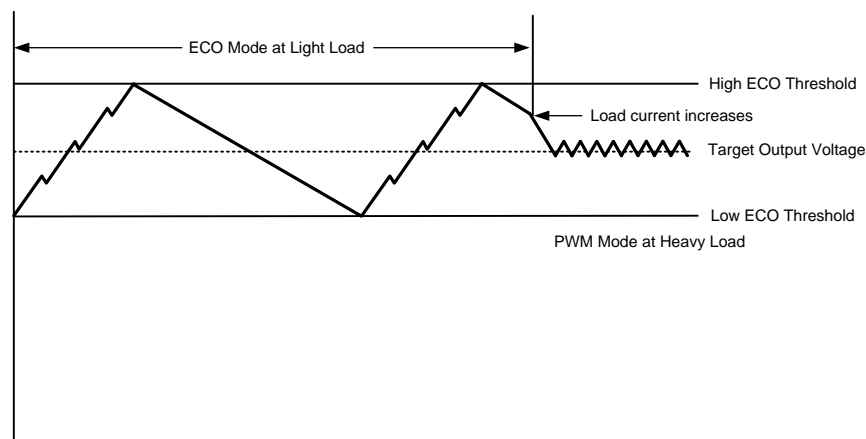

Figure 23. Operation in ECO Mode and Transfer to PWM Mode

Device Functional Modes (continued)

7.4.4 Sleep Mode Operation

When VCON is less than 80 mV in 7 μ s, the LM3262 goes into sleep mode — the SW pin is in tri-state (floating), which operates like ECO mode with no switching. The LM3262 device returns to normal operation immediately when VCON \geq 130 mV in PWM mode or ECO mode, depending on load detection.

7.4.5 Shutdown Mode

Setting the EN digital pin low ($<$ 0.4 V) places the LM3262 in shutdown mode (0.1 μ A typical). During shutdown, the PFET switch, the NFET synchronous rectifier, reference voltage source, control, and bias circuitry of the LM3262 are turned off. Setting EN high ($>$ 1.2 V) enables normal operation. EN must be set low to turn off the LM3262 during power-up and undervoltage conditions when the power supply is less than the 2.5-V minimum operating voltage. The LM3262 has an undervoltage lockout (UVLO) comparator to turn the power device off in the case the input voltage or battery voltage is too low. The typical UVLO threshold is approximately 2 V for lock and 2.1 V for release.

Table 1. Description Of Modes⁽¹⁾

MODE	EN	BPEN	VCON	I _{OUT} (APPROX.)	FB RES
Shutdown	0	X	X	X	Open
Sleep	1	X	$<$ 80 mV	X	Open
PWM	1	0	$>$ 130 mV	$>$ 180 mA	Closed
ECO	1	0	$<$ $(V_{IN} - 0.2)/2.5$	$<$ 140 mA	Closed
Auto bypass	1	0	$>$ $(V_{IN} - 0.2)/2.5$	X	Closed
Forced bypass	1	1	$>$ 130 mV	X	Closed
	1	0	$>$ 1.5 V	X	Closed

(1) X = Don't care.

8 Application and Implementation

NOTE

Information in the following applications sections is not part of the TI component specification, and TI does not warrant its accuracy or completeness. TI's customers are responsible for determining suitability of components for their purposes. Customers should validate and test their design implementation to confirm system functionality.

8.1 Application Information

The LM3262 DC-DC converter steps down an input voltage from 2.5 V to 5.5 V to a dynamically adjustable output voltage of 0.4 V to 3.6 V.

8.2 Typical Application

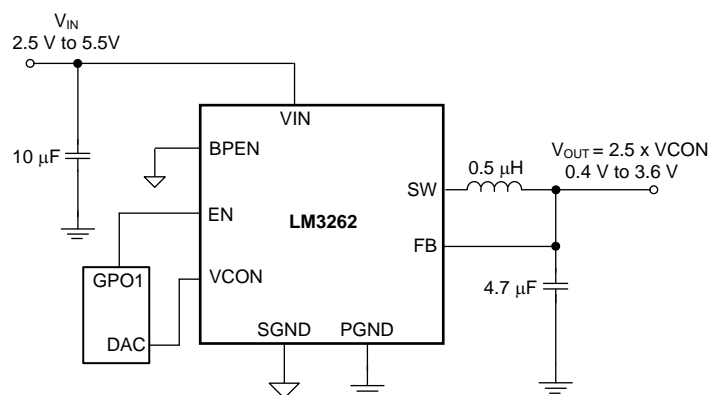

Figure 24. LM3262 Typical Application

8.2.1 Design Requirements

For the typical LM3262 buck regulator, use the parameters listed in [Table 2](#).

Table 2. Design Parameters

DESIGN PARAMETER	EXAMPLE VALUE
Input voltage	2.5 V to 5.5 V
Output voltage	0.4 V to 3.6 V
Output current	800 mA

8.2.2 Detailed Design Procedure

8.2.2.1 Inductor Selection

There are two main considerations when choosing an inductor: the inductor must not saturate, and the inductor current ripple is small enough to achieve the desired output voltage ripple. Different manufacturers follow different saturation current rating specifications, so attention must be given to details. Saturation current ratings are typically specified at 25°C so ratings over the ambient temperature of application should be requested from manufacturer.

The minimum value of inductance to ensure good performance is 0.3 µH at bias current (I_{LIM} (typical)) over the ambient temperature range. Shielded inductors radiate less noise and are preferred. There are two methods to choose the inductor saturation current rating.

8.2.2.1.1 Method 1

The saturation current must be greater than the sum of the maximum load current and the worst-case average-to-peak inductor current. This is shown in [Equation 1](#) :

$$I_{SAT} > I_{OUT_MAX} + I_{RIPPLE}$$

where

$$I_{RIPPLE} = \left(\frac{V_{IN} - V_{OUT}}{2 \times L} \right) \times \left(\frac{V_{OUT}}{V_{IN}} \right) \times \left(\frac{1}{f} \right)$$

where

- I_{RIPPLE} : average-to-peak inductor current
- I_{OUT_MAX} : maximum load current (800 mA)
- V_{IN} : maximum input voltage in application
- L: minimum inductor value including worst-case tolerances (30% drop can be considered for Method 1)
- F: minimum switching frequency (5.7 MHz)
- V_{OUT} : output voltage

(1)

8.2.2.1.2 Method 2

A more conservative and recommended approach is to choose an inductor than can handle the maximum current limit of 1600 mA.

The resistance of the inductor must be less than 0.1 Ω for good efficiency. [Table 3](#) lists suggested inductors and suppliers.

Table 3. Suggested Inductors

MODEL	SIZE (W x L x H) (mm)	VENDOR
LQM21PNR50XGHL11	2 x 1.25 x 1	Murata
MIPSZ2012D0R5	2 x 1.2 x 1	FDK
LQM21PNR54MG0	2 x 1.25 x 0.9	Murata
LQM2MPNR47NG0	2 x 1.6 x 0.9	Murata
CIG21LR47M	2 x 1.25 x 1	Samsung
CKP2012NR47M	2 x 1.25 x 1	Taiyo Yuden

8.2.2.2 Capacitor Selection

The LM3262 is designed for use with ceramic capacitors for its input and output filters. Use a 10- μ F ceramic capacitor for input and a sum total of 4.7- μ F ceramic capacitance for the output. They should maintain at least 50% capacitance at DC bias and temperature conditions. Ceramic capacitors types such as X5R, X7R, and B are recommended for both filters. These provide an optimal balance between small size, cost, reliability, and performance for cell phones and similar applications. [Table 4](#) lists some suggested part numbers and suppliers. DC-bias characteristics of the capacitors must be considered when selecting the voltage rating and case size of the capacitor. If it is necessary to choose a 0603 (1608) size capacitor for V_{IN} and 0402 (1005) size capacitor for V_{OUT} , the operation of the LM3262 must be carefully evaluated on the system board. Use of a 2.2- μ F capacitor in conjunction with multiple 0.47- μ F or 1- μ F capacitors in parallel may also be considered when connecting to power amplifier devices that require local decoupling.

Table 4. Suggested Capacitors And Their Suppliers

CAPACITANCE	MODEL	SIZE (W × L) (mm)	VENDOR
2.2 μF	GRM155R60J225M	1 × 0.5	Murata
2.2 μF	C1005X5R0J225M	1 × 0.5	TDK
2.2 μF	CL05A225MQ5NSNC	1 × 0.5	Samsung
4.7 μF	C1608JB0J475M	1.6 × 0.8	TDK
4.7 μF	C1005X5R0J475M	1 × 0.5	TDK
4.7 μF	CL05A475MQ5NRNC	1 × 0.5	Samsung
10 μF	C1608X5R0J106M	1.6 × 0.8	TDK
10 μF	GRM155r60J106M	1 × 0.5	Murata
10 μF	CL05A106MQ5NUNC	1 × 0.5	Samsung

The input filter capacitor supplies AC current drawn by the PFET switch of the LM3262 in the first part of each cycle and reduces the voltage ripple imposed on the input power source. The output filter capacitor absorbs the AC inductor current, helps maintain a steady output voltage during transient load changes and reduces output voltage ripple. These capacitors must be selected with sufficient capacitance and sufficiently low ESR to perform these functions. The equivalent series resistance (ESR) of the filter capacitors is generally a major factor in voltage ripple.

8.2.2.3 Setting The Output Voltage

The LM3262 features a pin-controlled adjustable output voltage to eliminate the need for external feedback resistors. It can be programmed for an output voltage from 0.4 V to 3.6 V by setting the voltage on the VCON pin, as in [Equation 2](#):

$$V_{OUT} = 2.5 \times VCON \quad (2)$$

When VCON is between 0.16 V and 1.44 V, the output voltage follows proportionally by $2.5 \times VCON$.

If VCON is less than 0.16 V ($V_{OUT} = 0.4$ V), the output voltage may not be well regulated. Refer to [Figure 22](#) for details. This curve exhibits the characteristics of a typical part, and the performance cannot be ensured as there may be a part-to-part variation for output voltages less than 0.4 V. For V_{OUT} lower than 0.4 V, the converter may suffer from larger output ripple voltage and higher current limit operation.

8.2.2.4 FB

Typically the FB pin is connected to VOUT for regulating the output voltage maximum of 3.6 V. In any application case, the voltage on FB pin should not exceed 4.5 V.

8.2.3 Application Curves

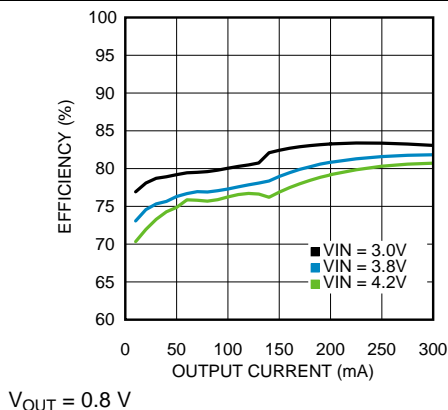

Figure 25. Efficiency vs Output Current

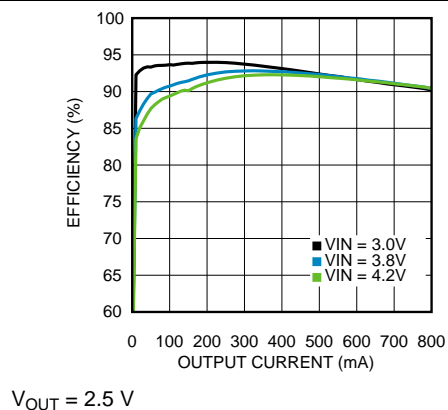

Figure 26. Efficiency vs Output Current

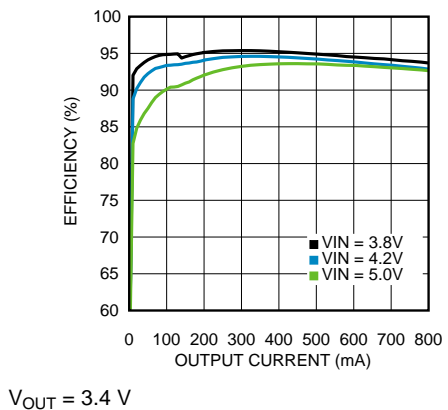

Figure 27. Efficiency vs Output Current

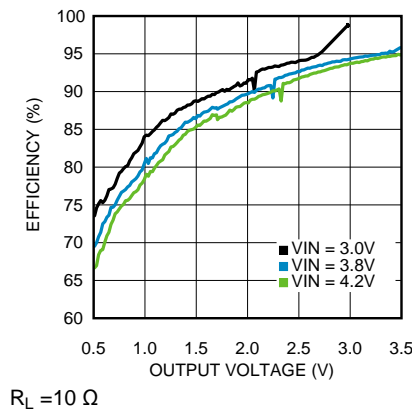

Figure 28. Efficiency vs Output Voltage

9 Power Supply Recommendations

The LM3262 device is designed to operate from an input voltage supply range from 2.5 V to 5.5 V. This input supply should be well-regulated and able to withstand maximum input current and maintain stable voltage without voltage drop even at load transition condition.

10 Layout

10.1 Layout Guidelines

PC board layout is critical to successfully designing a DC-DC converter into a product. As much as a 20-dB improvement in RX noise floor can be achieved by carefully following recommended layout practices. A properly planned board layout optimizes the performance of a DC-DC converter and minimizes effects on surrounding circuitry while also addressing manufacturing issues that can have adverse impacts on board quality and final product yield.

Poor board layout can disrupt the performance of a DC-DC converter and surrounding circuitry by contributing to EMI, ground bounce, and resistive voltage loss in the traces. Erroneous signals could be sent to the DC-DC converter device, resulting in poor regulation or instability. Poor layout can also result in re-flow problems leading to poor solder joints between the DSBGA package and board pads. Poor solder joints can result in erratic or degraded performance of the converter.

10.1.1 Energy Efficiency

Minimize resistive losses by using wide traces between the power components and doubling up traces on multiple layers when possible.

10.1.2 EMI

By its very nature, any switching converter generates electrical noise, and the design challenge is to minimize, contain, or attenuate such switcher-generated noise. A high-frequency switching converter, such as the LM3262, switches Ampere level currents within nanoseconds, and the traces interconnecting the associated components can act as radiating antennas. The following guidelines are offered to help to ensure that EMI is maintained within tolerable levels.

To minimize radiated noise:

- Place the LM3262 switcher, input capacitor, output filter inductor, and output filter capacitor close together, making the interconnecting traces as short as possible.
- Arrange the components so that the switching current loops curl in the same direction. During the first half of each cycle, current flows from the input filter capacitor, through the internal PFET of the LM3262 and the inductor, to the output filter capacitor, then back through ground, forming a current loop. In the second half of each cycle, current is pulled up from ground, through the internal synchronous NFET of the LM3262 by the inductor, to the output filter capacitor and then back through ground, forming a second current loop. Routing these loops so the current curls in the same direction prevents magnetic field reversal between the two half-cycles and reduces radiated noise.
- Make the current loop area(s) as small as possible.

To minimize ground-plane noise:

- Reduce the amount of switching current that circulates through the ground plane — connect the ground bumps of the LM3262 and its input filter capacitor together using generous component-side copper fill as a pseudo-ground plane. Then connect this copper fill to the system ground-plane (if one is used) with multiple vias. These multiple vias help to minimize ground bounce at the LM3262 by giving it a low-impedance ground connection.

To minimize coupling to the voltage feedback trace of the DC-DC converter:

- Route noise sensitive traces, such as the voltage feedback path, as directly as possible from the switcher FB pad to the VOUT pad of the output capacitor, but keep it away from noisy traces between the power components.

To decouple common power supply lines, series impedances may be used to strategically isolate circuits:

- Take advantage of the inherent inductance of circuit traces to reduce coupling among function blocks, by way of the power supply traces.
- Use star connection for separately routing VBATT to PVIN and VBATT_PA.
- Inserting a single ferrite bead in-line with a power supply trace may offer a favorable tradeoff in terms of board area by allowing the use of fewer bypass capacitors.

Layout Guidelines (continued)

10.1.3 Manufacturing Considerations

The LM3262 package employs a 9-pin, 3-mm × 3-mm array of 250 micron solder balls, with a 0.4-mm pad pitch. The following simple design rules go a long way to ensuring a good layout:

- The pad size must be 0.225 ± 0.02 mm, and the solder mask opening must be 0.325 ± 0.02 mm.
- As a thermal relief, connect to each pad with 7-mil wide, 7-mil long traces, incrementally increasing each trace to its optimal width. Symmetry is important to ensure the solder bumps re-flow evenly (refer to *AN-1112 DSBGA Wafer Level Chip Scale Package (SNVA009)*).

10.2 Layout Examples

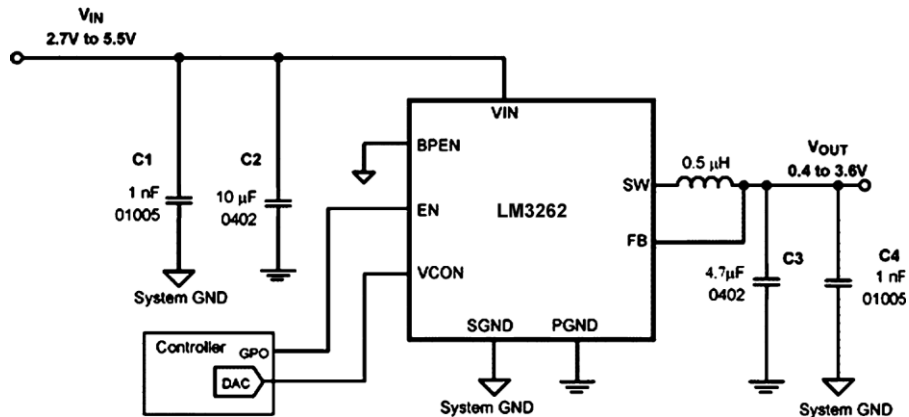

Figure 29. Simplified LM3262 RF Evaluation Board Schematic

1. Bulk Input Capacitor C2 must be placed closer to LM3262 than C1.
2. Add a 1-nF (C1) on input of LM3262 for high frequency filtering.
3. Bulk Output Capacitor C3 must be placed closer to LM3262 than C4.
4. Add a 1-nF (C4) on output of LM3262 for high frequency filtering.
5. Connect both GND terminals of C1 and C4 directly to system GND layer of phone board.
6. Connect bumps SGND (A2), NC (B2), BPEN (C1) directly to System GND.
7. Use 0402 caps for both C2 and C3 due to better high frequency filtering characteristics over 0603 capacitors.
8. TI has seen some improvement in high-frequency filtering for small bypass caps (C1 and C4) when they are connected to System GND instead of same ground as PGND. These capacitors should be 01005 case size for minimum footprint and best high frequency characteristics.

Layout Examples (continued)

Figure 30. LM3262 Recommended Parts Placement (Top View)

10.2.1 Component Placement

- PVIN
 1. Use a star connection from PVIN to LM3262 and PVIN to PA VBATT connection (V_{CC1}). Do not daisy-chain PVIN connection to LM3262 circuit and then to PA device PVIN connection.
- TOP LAYER
 1. Place a via in LM3262 SGND(A2), BPEN(C1) pads to drop and connect directly to System GND Layer 4.
 2. Place two vias at LM3262 SW solder bump to drop VSW trace to Layer 3.
 3. Connect C2 and C3 capacitor GND pads to PGND bump on LM3262 using a star connection. Place vias in C2 and C3 GND pads that connect directly to System GND Layer 4.
 4. Add 01005/0201 capacitor footprints (C1, C4) to input/output of LM3262 for improved high frequency filtering. C1 and C4 GND pads connect directly to System GND Layer 4.
 5. Place three vias at L1 inductor pad to bring up VSW trace from Layer 3 to Top Layer.
- LAYER 2
 1. Make FB trace at least 10 mils (0.254 mm) wide.
 2. Isolate FB trace away from noisy nodes and connect directly to C3 output capacitor. Place a via in LM3262 SGND (A2), BPEN (C1) pads to drop and connect directly to System GND Layer 4.
- LAYER 3
 1. Make VSW trace at least 15 mils (0.381 mm) wide.
- LAYER 4 (System GND)
 1. Connect C2 and C3 PGND vias to this layer.
 2. Connect C1 and C4 GND vias to this layer.
 3. Connect LM3262 SGND (A2), BPEN (C1), and NC (B2) pad vias to this layer.

Layout Examples (continued)

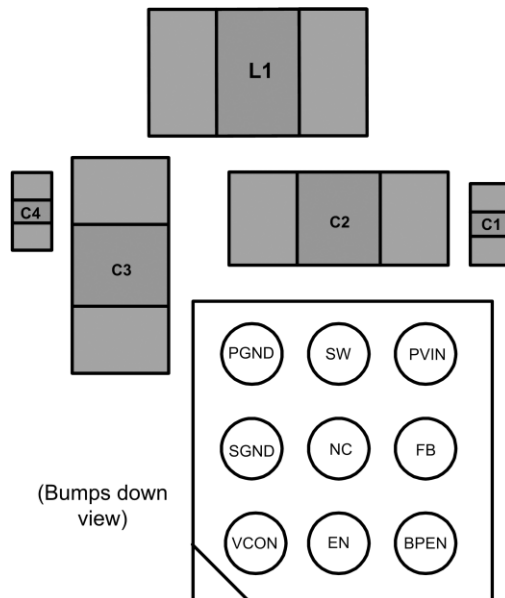
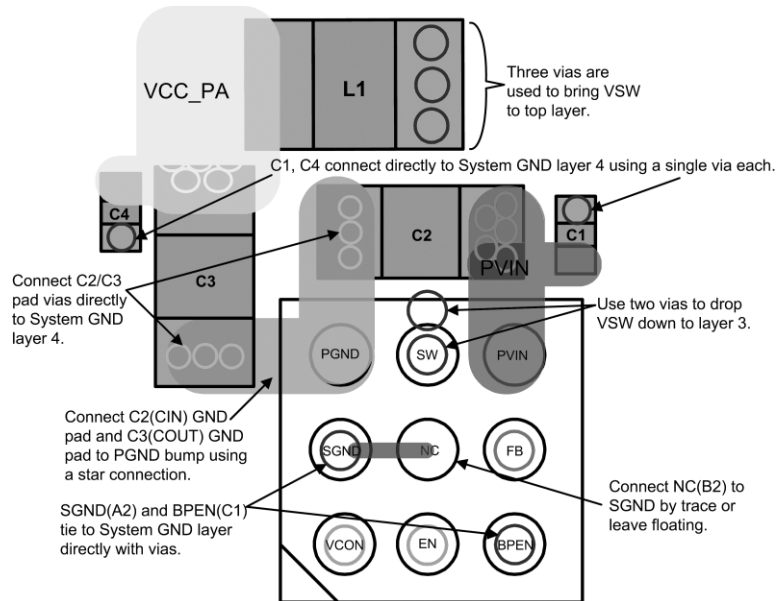

Figure 31. Board Layer 1 — PVIN and PGND Routing

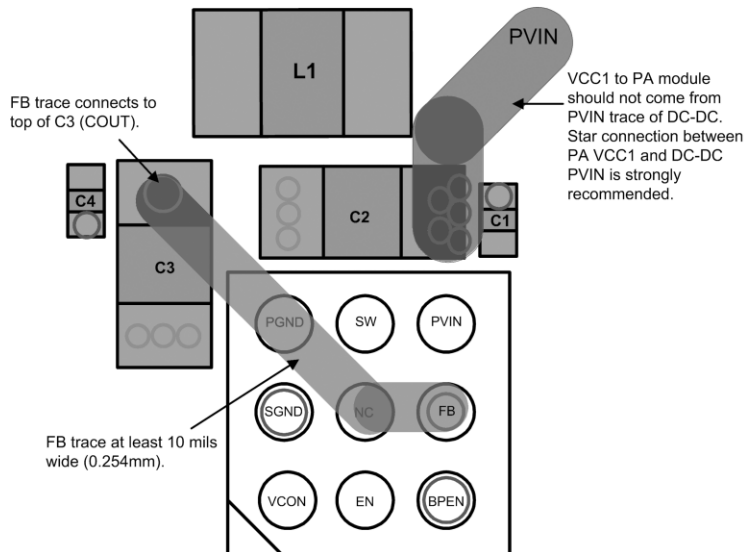

Figure 32. Board Layer 2 — FB and PVIN Routing

Layout Examples (continued)

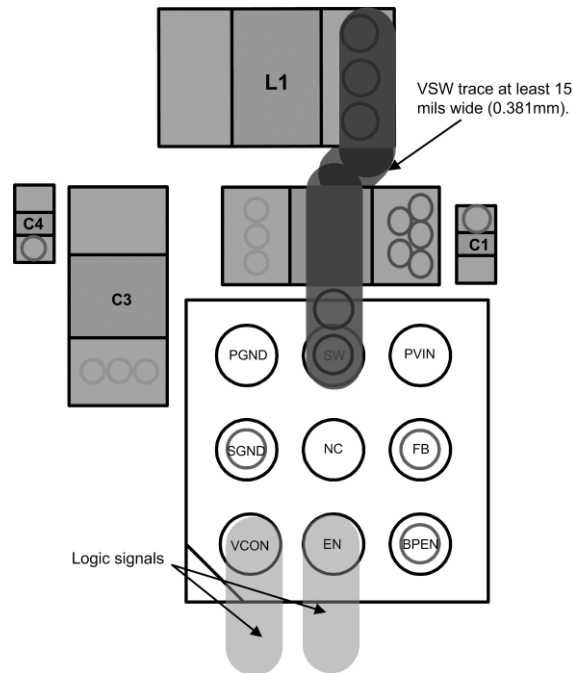

Figure 33. Board Layer 3 — SW, VCON and EN Routing

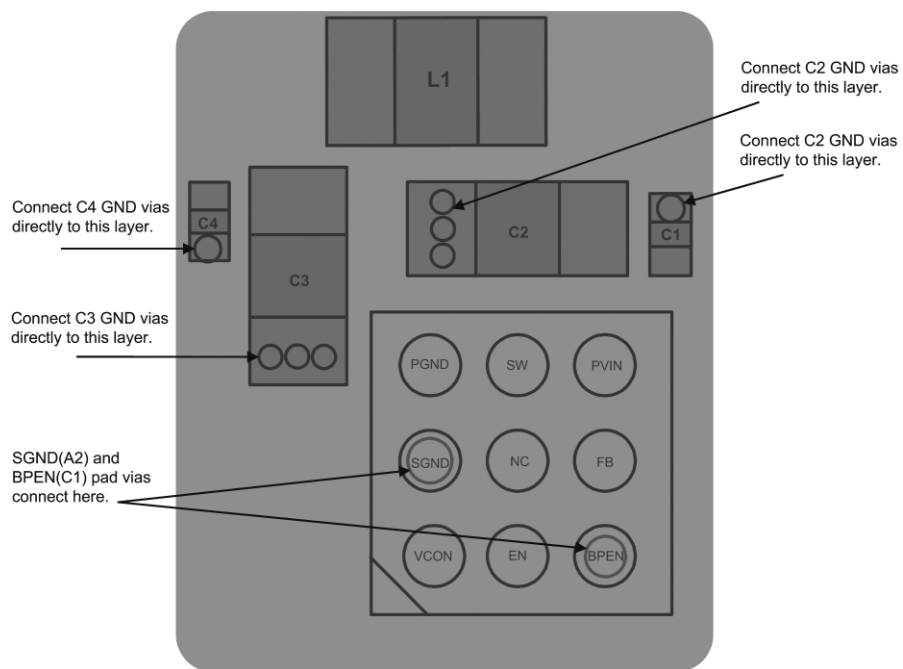

Figure 34. Board Layer 4 — System GND Plane

10.3 DSBGA Assembly and Use

Use of the DSBGA package requires specialized board layout, precision mounting, and careful re-flow techniques, as detailed in *AN-1112 DSBGA Wafer Level Chip Scale Package (SNVA009)*. Refer to the section regarding surface mount technology assembly. For best results in assembly, alignment ordinals on the PC board must be used to facilitate placement of the device. The pad style used with DSBGA package must be the NSMD (non-solder mask defined) type. This means that the solder-mask opening is larger than the pad size. This prevents a lip that otherwise forms if the solder-mask and pad overlap from holding the device off the surface of the board and interfering with mounting. See [SNVA009](#) for specific instructions on how to do this.

The 9-pin package used for the LM3262 has 250 micron solder balls and requires 0.225-mm pads for mounting on the circuit board. The trace to each pad must enter the pad with a 90° angle to prevent debris from being caught in deep corners. Initially, as a thermal relief, the trace to each pad must be a width of 7 mil for a section approximately 7 mil long. Each trace must neck up or down to its optimal width. The important criterion is symmetry. This ensures the solder bumps on the LM3262 re-flow evenly, and that the device solders level to the board. In particular, special attention must be paid to the pads for bumps A3 and C3. Because VIN and PGND are typically connected to large copper planes, inadequate thermal reliefs can result in late or inadequate re-flow of these bumps.

The DSBGA package is optimized for the smallest possible size in applications with red or infrared opaque cases. Because the DSBGA package lacks the plastic encapsulation characteristic of larger devices, it is vulnerable to light. Backside metallization and/or epoxy coating, along with front-side shading by the printed circuit board, reduce this sensitivity. However, the package has exposed die edges. In particular, DSBGA devices are sensitive to light, in the red and infrared range, shining on exposed die edges of the package.

TI recommends using a 10-nF capacitor between VCON and ground for non-standard ESD events or environments and manufacturing processes to prevent unexpected output voltage drift.

11 器件和文档支持

11.1 器件支持

11.1.1 Third-Party Products Disclaimer

TI'S PUBLICATION OF INFORMATION REGARDING THIRD-PARTY PRODUCTS OR SERVICES DOES NOT CONSTITUTE AN ENDORSEMENT REGARDING THE SUITABILITY OF SUCH PRODUCTS OR SERVICES OR A WARRANTY, REPRESENTATION OR ENDORSEMENT OF SUCH PRODUCTS OR SERVICES, EITHER ALONE OR IN COMBINATION WITH ANY TI PRODUCT OR SERVICE.

11.2 文档支持

11.2.1 相关文档

更多信息，请参见以下文档：

AN-1112 《DSBGA 晶圆级芯片规模封装》（文献编号：[SNVA009](#)）

11.3 社区资源

The following links connect to TI community resources. Linked contents are provided "AS IS" by the respective contributors. They do not constitute TI specifications and do not necessarily reflect TI's views; see TI's [Terms of Use](#).

TI E2E™ Online Community *TI's Engineer-to-Engineer (E2E) Community*. Created to foster collaboration among engineers. At e2e.ti.com, you can ask questions, share knowledge, explore ideas and help solve problems with fellow engineers.

Design Support *TI's Design Support* Quickly find helpful E2E forums along with design support tools and contact information for technical support.

11.4 商标

E2E is a trademark of Texas Instruments.
All other trademarks are the property of their respective owners.

11.5 静电放电警告



ESD 可能会损坏该集成电路。德州仪器 (TI) 建议通过适当的预防措施处理所有集成电路。如果不遵守正确的处理措施和安装程序，可能会损坏集成电路。

ESD 的损坏小至导致微小的性能降级，大至整个器件故障。精密的集成电路可能更容易受到损坏，这是因为非常细微的参数更改都可能会导致器件与其发布的规格不相符。

11.6 Glossary

[SLYZ022](#) — *TI Glossary*.

This glossary lists and explains terms, acronyms, and definitions.

12 机械、封装和可订购信息

以下页中包括机械、封装和可订购信息。这些信息是针对指定器件可提供的最新数据。这些数据会在无通知且不对本文档进行修订的情况下发生改变。欲获得该数据表的浏览器版本，请查阅左侧的导航栏。

重要声明

德州仪器(TI)及其下属子公司有权根据 JESD46 最新标准,对所提供的产品和服务进行更正、修改、增强、改进或其它更改,并有权根据 JESD48 最新标准中止提供任何产品和服务。客户在下订单前应获取最新的相关信息,并验证这些信息是否完整且是最新的。所有产品的销售都遵循在订单确认时所提供的TI 销售条款与条件。

TI 保证其所销售的组件的性能符合产品销售时 TI 半导体产品销售条件与条款的适用规范。仅在 TI 保证的范围内,且 TI 认为有必要时才会使用测试或其它质量控制技术。除非适用法律做出了硬性规定,否则没有必要对每种组件的所有参数进行测试。

TI 对应用帮助或客户产品设计不承担任何义务。客户应对其使用 TI 组件的产品和应用自行负责。为尽量减小与客户产品和应用相关的风险,客户应提供充分的设计与操作安全措施。

TI 不对任何 TI 专利权、版权、屏蔽作品权或其它与使用了 TI 组件或服务的组合设备、机器或流程相关的 TI 知识产权中授予的直接或隐含权限作出任何保证或解释。TI 所发布的与第三方产品或服务有关的信息,不能构成从 TI 获得使用这些产品或服务的许可、授权、或认可。使用此类信息可能需要获得第三方的专利权或其它知识产权方面的许可,或是 TI 的专利权或其它知识产权方面的许可。

对于 TI 的产品手册或数据表中 TI 信息的重要部分,仅在没有对内容进行任何篡改且带有相关授权、条件、限制和声明的情况下才允许进行复制。TI 对此类篡改过的文件不承担任何责任或义务。复制第三方的信息可能需要服从额外的限制条件。

在转售 TI 组件或服务时,如果对该组件或服务参数的陈述与 TI 标明的参数相比存在差异或虚假成分,则会失去相关 TI 组件或服务的所有明示或暗示授权,且这是不正当的、欺诈性商业行为。TI 对任何此类虚假陈述均不承担任何责任或义务。

客户认可并同意,尽管任何应用相关信息或支持仍可能由 TI 提供,但他们将独立负责满足与其产品及其在应用中使用的 TI 产品相关的所有法律、法规和安全相关要求。客户声明并同意,他们具备制定与实施安全措施所需的全部专业技术和知识,可预见故障的危险后果、监测故障及其后果、降低有可能造成人身伤害的故障的发生机率并采取适当的补救措施。客户将全额赔偿因在此类安全关键应用中使用任何 TI 组件而对 TI 及其代理造成的任何损失。

在某些场合中,为了推进安全相关应用有可能对 TI 组件进行特别的促销。TI 的目标是利用此类组件帮助客户设计和创立其特有的可满足适用的功能安全性标准和要求的终端产品解决方案。尽管如此,此类组件仍然服从这些条款。

TI 组件未获得用于 FDA Class III (或类似的生命攸关医疗设备)的授权许可,除非各方授权官员已经达成了专门管控此类使用的特别协议。

只有那些 TI 特别注明属于军用等级或“增强型塑料”的 TI 组件才是设计或专门用于军事/航空应用或环境的。购买者认可并同意,对并非指定面向军事或航空航天用途的 TI 组件进行军事或航空航天方面的应用,其风险由客户单独承担,并且由客户独立负责满足与此类使用相关的所有法律和法规要求。

TI 已明确指定符合 ISO/TS16949 要求的产品,这些产品主要用于汽车。在任何情况下,因使用非指定产品而无法达到 ISO/TS16949 要求, TI 不承担任何责任。

	产品		应用
数字音频	www.ti.com.cn/audio	通信与电信	www.ti.com.cn/telecom
放大器和线性器件	www.ti.com.cn/amplifiers	计算机及周边	www.ti.com.cn/computer
数据转换器	www.ti.com.cn/dataconverters	消费电子	www.ti.com.cn/consumer-apps
DLP® 产品	www.dlp.com	能源	www.ti.com.cn/energy
DSP - 数字信号处理器	www.ti.com.cn/dsp	工业应用	www.ti.com.cn/industrial
时钟和计时器	www.ti.com.cn/clockandtimers	医疗电子	www.ti.com.cn/medical
接口	www.ti.com.cn/interface	安防应用	www.ti.com.cn/security
逻辑	www.ti.com.cn/logic	汽车电子	www.ti.com.cn/automotive
电源管理	www.ti.com.cn/power	视频和影像	www.ti.com.cn/video
微控制器 (MCU)	www.ti.com.cn/microcontrollers		
RFID 系统	www.ti.com.cn/rfidsys		
OMAP应用处理器	www.ti.com/omap		
无线连通性	www.ti.com.cn/wirelessconnectivity	德州仪器在线技术支持社区	www.deyisupport.com

邮寄地址: 上海市浦东新区世纪大道1568号, 中建大厦32楼邮政编码: 200122
Copyright © 2016, 德州仪器半导体技术(上海)有限公司

PACKAGING INFORMATION

Orderable Device	Status (1)	Package Type	Package Drawing	Pins	Package Qty	Eco Plan (2)	Lead/Ball Finish (6)	MSL Peak Temp (3)	Op Temp (°C)	Device Marking (4/5)	Samples
LM3262TME/NOPB	ACTIVE	DSBGA	YFQ	9	250	Green (RoHS & no Sb/Br)	SNAGCU	Level-1-260C-UNLIM	-30 to 90	S6	Samples
LM3262TMX/NOPB	ACTIVE	DSBGA	YFQ	9	3000	Green (RoHS & no Sb/Br)	SNAGCU	Level-1-260C-UNLIM	-30 to 90	S6	Samples

(1) The marketing status values are defined as follows:

ACTIVE: Product device recommended for new designs.

LIFEBUY: TI has announced that the device will be discontinued, and a lifetime-buy period is in effect.

NRND: Not recommended for new designs. Device is in production to support existing customers, but TI does not recommend using this part in a new design.

PREVIEW: Device has been announced but is not in production. Samples may or may not be available.

OBSELETE: TI has discontinued the production of the device.

(2) Eco Plan - The planned eco-friendly classification: Pb-Free (RoHS), Pb-Free (RoHS Exempt), or Green (RoHS & no Sb/Br) - please check <http://www.ti.com/productcontent> for the latest availability information and additional product content details.

TBD: The Pb-Free/Green conversion plan has not been defined.

Pb-Free (RoHS): TI's terms "Lead-Free" or "Pb-Free" mean semiconductor products that are compatible with the current RoHS requirements for all 6 substances, including the requirement that lead not exceed 0.1% by weight in homogeneous materials. Where designed to be soldered at high temperatures, TI Pb-Free products are suitable for use in specified lead-free processes.

Pb-Free (RoHS Exempt): This component has a RoHS exemption for either 1) lead-based flip-chip solder bumps used between the die and package, or 2) lead-based die adhesive used between the die and leadframe. The component is otherwise considered Pb-Free (RoHS compatible) as defined above.

Green (RoHS & no Sb/Br): TI defines "Green" to mean Pb-Free (RoHS compatible), and free of Bromine (Br) and Antimony (Sb) based flame retardants (Br or Sb do not exceed 0.1% by weight in homogeneous material)

(3) MSL, Peak Temp. - The Moisture Sensitivity Level rating according to the JEDEC industry standard classifications, and peak solder temperature.

(4) There may be additional marking, which relates to the logo, the lot trace code information, or the environmental category on the device.

(5) Multiple Device Markings will be inside parentheses. Only one Device Marking contained in parentheses and separated by a "~" will appear on a device. If a line is indented then it is a continuation of the previous line and the two combined represent the entire Device Marking for that device.

(6) Lead/Ball Finish - Orderable Devices may have multiple material finish options. Finish options are separated by a vertical ruled line. Lead/Ball Finish values may wrap to two lines if the finish value exceeds the maximum column width.

Important Information and Disclaimer:The information provided on this page represents TI's knowledge and belief as of the date that it is provided. TI bases its knowledge and belief on information provided by third parties, and makes no representation or warranty as to the accuracy of such information. Efforts are underway to better integrate information from third parties. TI has taken and continues to take reasonable steps to provide representative and accurate information but may not have conducted destructive testing or chemical analysis on incoming materials and chemicals. TI and TI suppliers consider certain information to be proprietary, and thus CAS numbers and other limited information may not be available for release.

In no event shall TI's liability arising out of such information exceed the total purchase price of the TI part(s) at issue in this document sold by TI to Customer on an annual basis.

TAPE AND REEL INFORMATION



QUADRANT ASSIGNMENTS FOR PIN 1 ORIENTATION IN TAPE



*All dimensions are nominal

Device	Package Type	Package Drawing	Pins	SPQ	Reel Diameter (mm)	Reel Width W1 (mm)	A0 (mm)	B0 (mm)	K0 (mm)	P1 (mm)	W (mm)	Pin1 Quadrant
LM3262TME/NOPB	DSBGA	YFQ	9	250	178.0	8.4	1.57	1.57	0.76	4.0	8.0	Q1
LM3262TMX/NOPB	DSBGA	YFQ	9	3000	178.0	8.4	1.57	1.57	0.76	4.0	8.0	Q1

TAPE AND REEL BOX DIMENSIONS

*All dimensions are nominal

Device	Package Type	Package Drawing	Pins	SPQ	Length (mm)	Width (mm)	Height (mm)
LM3262TME/NOPB	DSBGA	YFQ	9	250	210.0	185.0	35.0
LM3262TMX/NOPB	DSBGA	YFQ	9	3000	210.0	185.0	35.0

YFQ0009

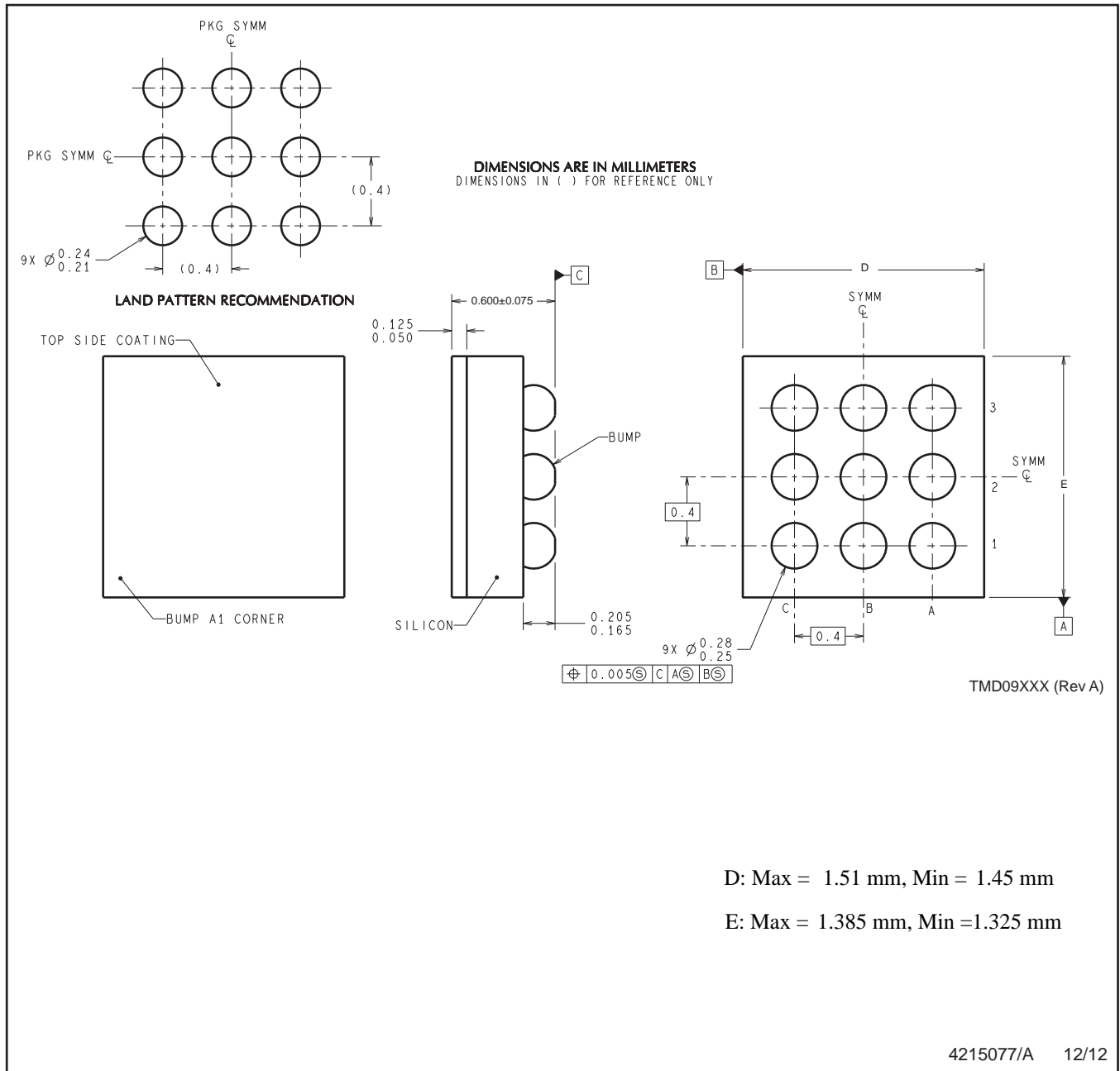

NOTES: A. All linear dimensions are in millimeters. Dimensioning and tolerancing per ASME Y14.5M-1994.
B. This drawing is subject to change without notice.

重要声明

德州仪器 (TI) 公司有权按照最新发布的 JESD46 对其半导体产品和服务进行纠正、增强、改进和其他修改，并不再按最新发布的 JESD48 提供任何产品和服务。买方在下订单前应获取最新的相关信息，并验证这些信息是否完整且是最新的。

TI 公布的半导体产品销售条款 (<http://www.ti.com/sc/docs/stdterms.htm>) 适用于 TI 已认证和批准上市的已封装集成电路产品的销售。另有其他条款可能适用于其他类型 TI 产品及服务的使用或销售。

复制 TI 数据表上 TI 信息的重要部分时，不得变更该等信息，且必须随附所有相关保证、条件、限制和通知，否则不得复制。TI 对该等复制文件不承担任何责任。第三方信息可能受到其它限制条件的制约。在转售 TI 产品或服务时，如果存在对产品或服务参数的虚假陈述，则会失去相关 TI 产品或服务的明示或暗示保证，且构成不公平的、欺诈性商业行为。TI 对此类虚假陈述不承担任何责任。

买方和在系统中整合 TI 产品的其他开发人员（总称“设计人员”）理解并同意，设计人员在设计应用时应自行实施独立的分析、评价和判断，且应全权负责并确保应用的安全性，及设计人员的应用（包括应用中使用的 TI 产品）应符合所有适用的法律法规及其他相关要求。设计人员就自己设计的应用声明，其具备制订和实施下列保障措施所需的一切必要专业知识，能够 (1) 预见故障的危险后果，(2) 监视故障及其后果，以及 (3) 降低可能导致危险的故障几率并采取适当措施。设计人员同意，在使用或分发包含 TI 产品的任何应用前，将彻底测试该等应用和该等应用中所用 TI 产品的功能。

TI 提供技术、应用或其他设计建议、质量特点、可靠性数据或其他服务或信息，包括但不限于与评估模块有关的参考设计和材料（总称“TI 资源”），旨在帮助设计人员开发整合了 TI 产品的应用，如果设计人员（个人，或如果是代表公司，则为设计人员的公司）以任何方式下载、访问或使用任何特定的 TI 资源，即表示其同意仅为该等目标，按照本通知的条款使用任何特定 TI 资源。

TI 所提供的 TI 资源，并未扩大或以其他方式修改 TI 对 TI 产品的公开适用的质保及质保免责声明；也未导致 TI 承担任何额外的义务或责任。TI 有权对其 TI 资源进行纠正、增强、改进和其他修改。除特定 TI 资源的公开文档中明确列出的测试外，TI 未进行任何其他测试。

设计人员只有在开发包含该等 TI 资源所列 TI 产品的应用时，才被授权使用、复制和修改任何相关 TI 资源。但并未依据禁止反言原则或其他法律授予您任何 TI 知识产权的任何其他明示或暗示的许可，也未授予您 TI 或第三方的任何技术或知识产权的许可，该等许可包括但不限于任何专利权、版权、屏蔽作品权或与美国 TI 产品或服务的任何整合、机器制作、流程相关的其他知识产权。涉及或参考了第三方产品或服务的信息不构成使用此类产品或服务的许可或与其相关的保证或认可。使用 TI 资源可能需要您向第三方获得对该等第三方专利或其他知识产权的许可。

TI 资源系“按原样”提供。TI 兹免除对资源及其使用作出所有其他明确或默认为的保证或陈述，包括但不限于对准确性或完整性、产权保证、无屡发故障保证，以及适销性、适合特定用途和不侵犯任何第三方知识产权的任何默认保证。TI 不负责任何申索，包括但不限于因组合产品所致或与之有关的申索，也不为或对设计人员进行辩护或赔偿，即使该等产品组合已列于 TI 资源或其他地方。对因 TI 资源或其使用引起或与之有关的任何实际的、直接的、特殊的、附带的、间接的、惩罚性的、偶发的、从属或惩戒性损害赔偿，不管 TI 是否获悉可能会产生上述损害赔偿，TI 概不负责。

除 TI 已明确指出特定产品已达到特定行业标准（例如 ISO/TS 16949 和 ISO 26262）的要求外，TI 不对未达到任何该等行业标准要求而承担任何责任。

如果 TI 明确宣称产品有助于功能安全或符合行业功能安全标准，则该等产品旨在帮助客户设计和创作自己的符合相关功能安全标准和要求的的应用。在应用内使用产品的行为本身不会配有安全特性。设计人员必须确保遵守适用于其应用的相关安全要求和标准。设计人员不可将任何 TI 产品用于关乎性命的医疗设备，除非已由各方获得授权的管理人员签署专门的合同对此类应用专门作出规定。关乎性命的医疗设备是指出现故障会导致严重身体伤害或死亡的医疗设备（例如生命保障设备、心脏起搏器、心脏除颤器、人工心脏泵、神经刺激器以及植入设备）。此类设备包括但不限于，美国食品药品监督管理局认定为 III 类设备的设备，以及在美国以外的其他国家或地区认定为同等类别设备的所有医疗设备。

TI 可能明确指定某些产品具备某些特定资格（例如 Q100、军用级或增强型产品）。设计人员同意，其具备一切必要专业知识，可以为自己的应用选择适合的产品，并且正确选择产品的风险由设计人员承担。设计人员单方面负责遵守与该等选择有关的所有法律或监管要求。

设计人员同意向 TI 及其代表全额赔偿因其不遵守本通知条款和条件而引起的任何损害、费用、损失和/或责任。

邮寄地址：上海市浦东新区世纪大道 1568 号中建大厦 32 楼，邮政编码：200122
Copyright © 2017 德州仪器半导体技术（上海）有限公司