



FEATURES

Dual output

$f_{OUT} = 9.25 \text{ GHz to } 10.10 \text{ GHz}$

$f_{OUT}/2 = 4.625 \text{ GHz to } 5.050 \text{ GHz}$

Power output (P_{OUT}): 11 dBm (typical)

Single-sideband (SSB) phase noise: -115 dBc/Hz at 100 kHz

No external resonator needed

RoHS-compliant, 5 mm x 5 mm LFCSP: 25 mm²

APPLICATIONS

Point to point and multipoint radios

Test equipment and industrial controls

Very small aperture terminals (VSATs)

FUNCTIONAL BLOCK DIAGRAM

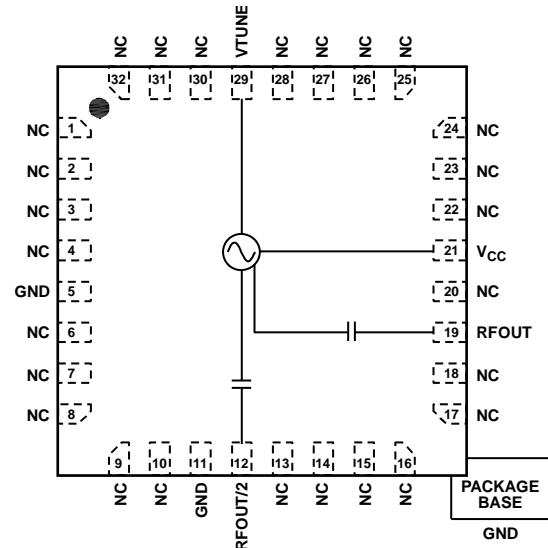

NOTES

1. NC = NO CONNECT. THESE PINS ARE NOT INTERNALLY CONNECTED. HOWEVER, THESE PINS CAN BE CONNECTED TO RF/DC GROUND WITHOUT AFFECTING THE PERFORMANCE OF THE DEVICE.

13066-001

Figure 1.

GENERAL DESCRIPTION

The HMC1162 is a monolithic microwave integrated circuit (MMIC), voltage controlled oscillator (VCO) that integrates the resonator, a negative resistance device, and varactor diodes, and features a half frequency output.

Because of the monolithic construction of the oscillator, the output power and phase noise performance are excellent over temperature.

The power output is 11 dBm typical from a 5 V supply voltage. The VCO is housed in a RoHS-compliant, 32-lead LFCSP and requires no external matching components.

HMC1162* PRODUCT PAGE QUICK LINKS

Last Content Update: 09/27/2017

COMPARABLE PARTS

View a parametric search of comparable parts.

EVALUATION KITS

- Evaluation Board for HMC1162LP5

DOCUMENTATION

Data Sheet

- HMC1162: 9.25 GHz to 10.10 GHz MMIC VCO with Half Frequency Output Data Sheet

REFERENCE MATERIALS

Quality Documentation

- Package/Assembly Qualification Test Report: LP3, LP4, LP5 & LP5G (QTR: 2014-00145)
- Semiconductor Qualification Test Report: GaAs HBT-A (QTR: 2013-00228)

DESIGN RESOURCES

- HMC1162 Material Declaration
- PCN-PDN Information
- Quality And Reliability
- Symbols and Footprints

DISCUSSIONS

View all HMC1162 EngineerZone Discussions.

SAMPLE AND BUY

Visit the product page to see pricing options.

TECHNICAL SUPPORT

Submit a technical question or find your regional support number.

DOCUMENT FEEDBACK

Submit feedback for this data sheet.

TABLE OF CONTENTS

Features	1	Interface Schematics	6
Applications.....	1	Typical Performance Characteristics	7
Functional Block Diagram	1	Applications Information	9
General Description	1	Evaluation Printed Circuit Board (PCB).....	10
Revision History	2	Bill of Materials.....	10
Specifications.....	3	Packaging and Ordering Information	11
Absolute Maximum Ratings	4	Outline Dimensions.....	11
ESD Caution.....	4	Ordering Guide	11
Pin Configuration and Function Descriptions.....	5		

REVISION HISTORY

9/15—v00.0914 to Rev. A

This Hittite Microwave Products data sheet has been reformatted to meet the styles and standards of Analog Devices, Inc.

Updated Format.....	Universal
Changes to Features Section and General Description Section.....	1
Deleted Frequency vs. Tuning Voltage, T = 25°C Graph; Renumbered Sequentially.....	2
Changes to Table 1	3
Deleted Reliability Information Table; Renumbered Sequentially	3

Changes to Table 2.....	4
Added Interface Schematics Section.....	6
Reordered Figure Sequence, Typical Performance Characteristics Section	7
Added Applications Information Section	9
Added Figure 16; Renumbered Sequentially	9
Changes to Table 4.....	10
Updated Outline Dimensions.....	11
Changes to Ordering Guide	11

SPECIFICATIONS

$T_A = -40^{\circ}\text{C}$ to $+85^{\circ}\text{C}$, $V_{CC} = 5\text{ V}$, unless otherwise noted.

Table 1.

Parameter	Min	Typ	Max	Unit	Test Conditions/Comments
FREQUENCY					
Range					
f_{OUT}	9.25		10.10	GHz	
$f_{OUT}/2$	4.625		5.050	GHz	
Drift Rate		1.0		MHz/ $^{\circ}\text{C}$	
Pulling		0.5		MHz p-p	Pulling into a 2.0:1 voltage standing wave ratio (VSWR)
Pushing		6		MHz/V	At VTUNE = 5 V
POWER OUTPUT (P_{OUT})					
RFOUT	7	11	15	dBm	
RFOUT/2	3	7.5	12	dBm	
Supply Current (I_{CC})		205		mA	$V_{CC} = 4.75\text{ V}$
	160	230	310	mA	$V_{CC} = 5.00\text{ V}$
		250		mA	$V_{CC} = 5.25\text{ V}$
HARMONICS, SUBHARMONICS					
1/2		39		dBc	
3/2		23		dBc	
Second		14		dBc	
Third		22		dBc	
TUNING					
Voltage (VTUNE)	2		13	V	
Sensitivity	50		350	MHz/V	
Tune Port Leakage Current			10	μA	VTUNE = 13 V
OUTPUT RETURN LOSS					
		7		dB	
SSB PHASE NOISE					
10 kHz Offset		-86	-83	dBc/Hz	
100 kHz Offset		-115	-110	dBc/Hz	

ABSOLUTE MAXIMUM RATINGS

Table 2.

Parameter	Rating
V_{CC}	5.5 V dc
VTUNE	0 V to 15 V
Temperature	
Operating	-40°C to +85°C
Storage	-65°C to +150°C
Nominal Junction (To Maintain 1 Million Hours Mean Time to Failure (MTTF))	135°C
Nominal Junction ($T_A = 85^\circ\text{C}$)	116.3°C
Maximum Reflow Temperature (MSL3 Rating)	260°C
Thermal Resistance (Junction to Exposed Pad)	24.3°C/W
ESD Sensitivity (Human Body Model)	Class 1A

Stresses at or above those listed under Absolute Maximum Ratings may cause permanent damage to the product. This is a stress rating only; functional operation of the product at these or any other conditions above those indicated in the operational section of this specification is not implied. Operation beyond the maximum operating conditions for extended periods may affect product reliability.

ESD CAUTION**ESD (electrostatic discharge) sensitive device.**

Charged devices and circuit boards can discharge without detection. Although this product features patented or proprietary protection circuitry, damage may occur on devices subjected to high energy ESD. Therefore, proper ESD precautions should be taken to avoid performance degradation or loss of functionality.

PIN CONFIGURATION AND FUNCTION DESCRIPTIONS

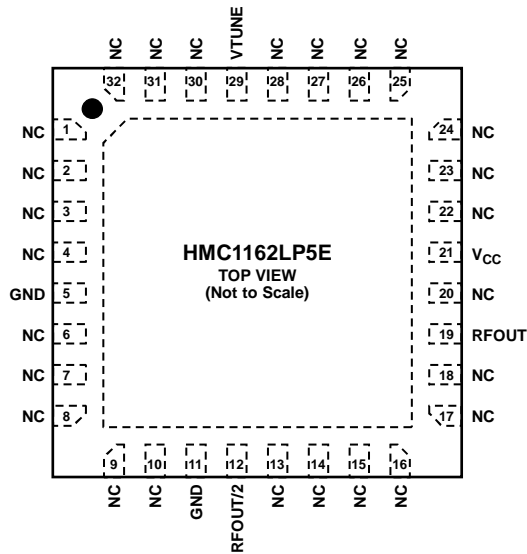

- NOTES**
1. NC = NO CONNECT. THESE PINS ARE NOT INTERNALLY CONNECTED. HOWEVER, THESE PINS CAN BE CONNECTED TO RF/DC GROUND WITHOUT AFFECTING THE PERFORMANCE OF THE DEVICE.
 2. THE PACKAGE BOTTOM HAS AN EXPOSED METAL PAD THAT MUST BE CONNECTED TO RF/DC GROUND.

Figure 2. Pin Configuration

Table 3. Pin Function Descriptions

Pin No.	Mnemonic	Description
1 to 4, 6 to 10, 13 to 18, 20, 22 to 28, 30 to 32	NC	No Connect. These pins are not internally connected. However, these pins can be connected to RF/dc ground without affecting the performance of the device.
5, 11	GND	Ground. These pins must be connected to RF/dc ground.
12	RFOUT/2	Half Frequency Output. This pin is ac-coupled.
19	RFOUT	RF Output. This pin is ac-coupled.
21	V _{CC}	Supply Voltage (5 V).
29	VTUNE	Control Voltage and Modulation Input. The modulation bandwidth is dependent on the drive source impedance.
	EP	Exposed Pad. The package bottom has an exposed metal pad that must be connected to RF/dc ground.

INTERFACE SCHEMATICS

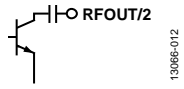

Figure 3. RFOUT/2 Interface

13086-012

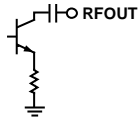

Figure 4. RFOUT Interface

13086-013

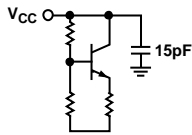

Figure 5. V_{CC} Interface

13086-014

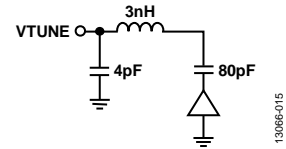

Figure 6. VTUNE Interface

13086-015



Figure 7. GND Interface

13086-016

TYPICAL PERFORMANCE CHARACTERISTICS

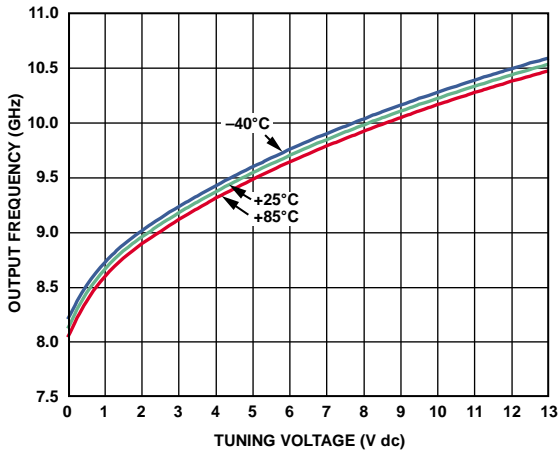

Figure 8. Output Frequency vs. Tuning Voltage

13086-003

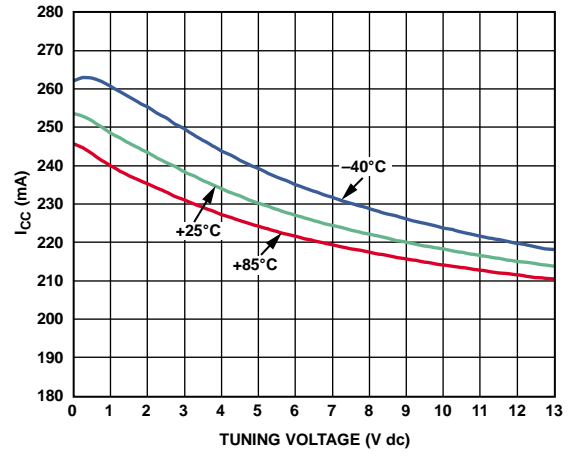

Figure 11. Supply Current vs. Tuning Voltage

13086-007

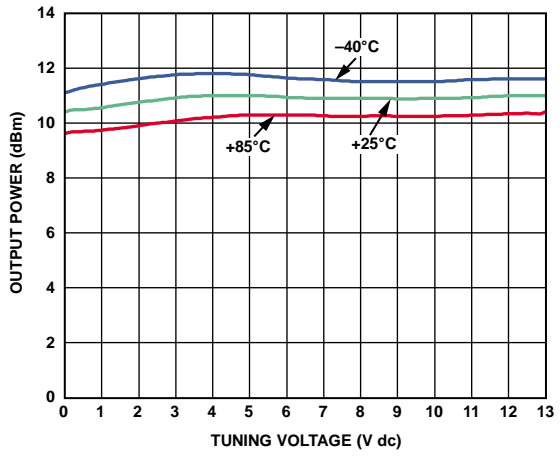

Figure 9. Output Power vs. Tuning Voltage

13086-009

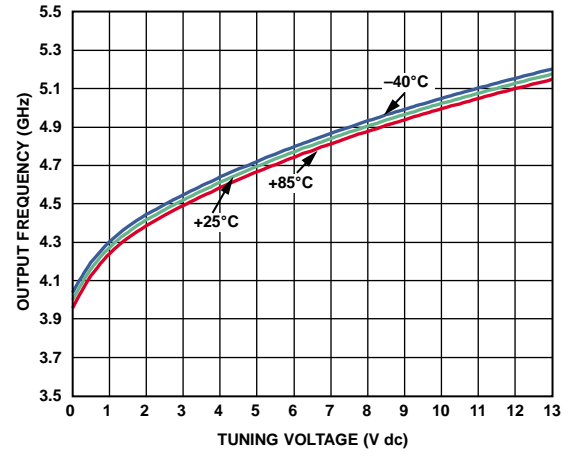

Figure 12. RFOUT/2 Output Frequency vs. Tuning Voltage

13086-006

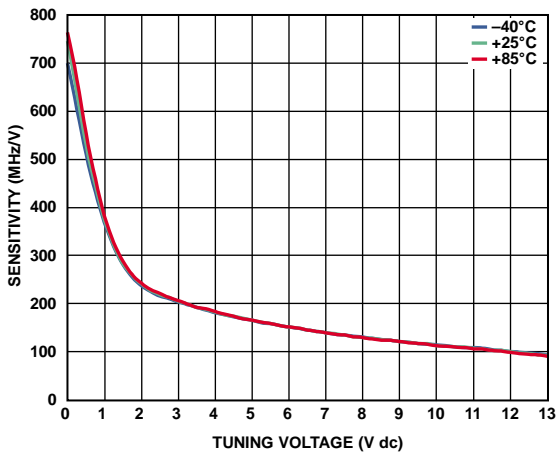

Figure 10. Sensitivity vs. Tuning Voltage

13086-004

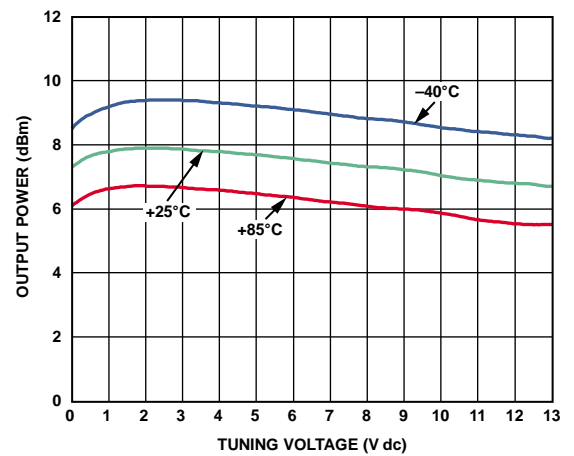

Figure 13. RFOUT/2 Output Power vs. Tuning Voltage

13086-011

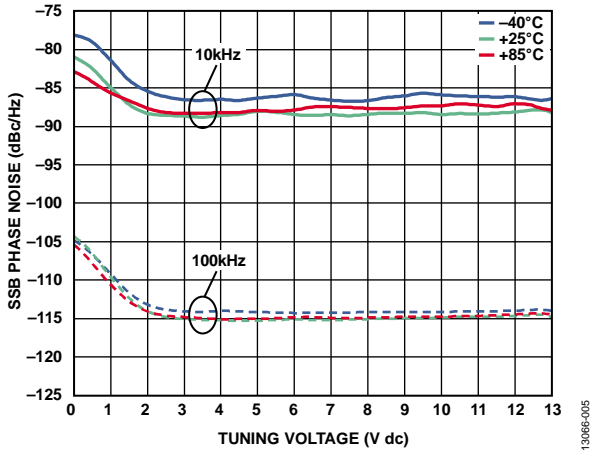

Figure 14. SSB Phase Noise vs. Tuning Voltage

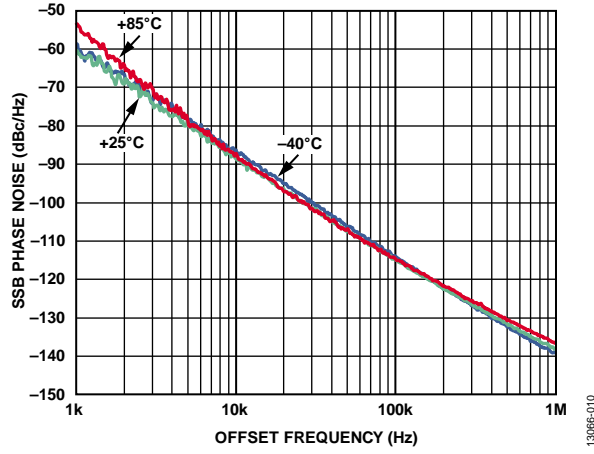

Figure 15. SSB Phase Noise vs. Offset Frequency at VTUNE = 5 V

APPLICATIONS INFORMATION

The HMC1162 serves as the local oscillator (LO) in microwave synthesizer applications. Point to point microwave radios, military, radars, test and measurement, as well as industrial and medical equipment are the primary applications. The low phase noise allows higher orders of modulation and offers improved bit error rates in communication systems, and the linear,

monotonic tuning sensitivity allows a stable loop filter design. The higher output power minimizes the gain required to drive subsequent stages. The half frequency output reduces the input frequency to the prescaler without the addition of residual phase noise to the input of the phase-locked loop synthesizer.

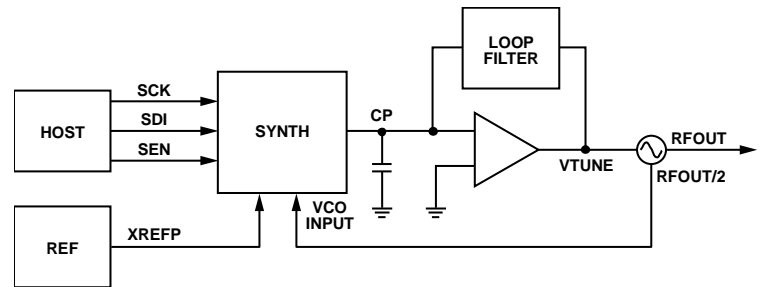

Figure 16. Typical Application Diagram

13066-018

EVALUATION PRINTED CIRCUIT BOARD (PCB)

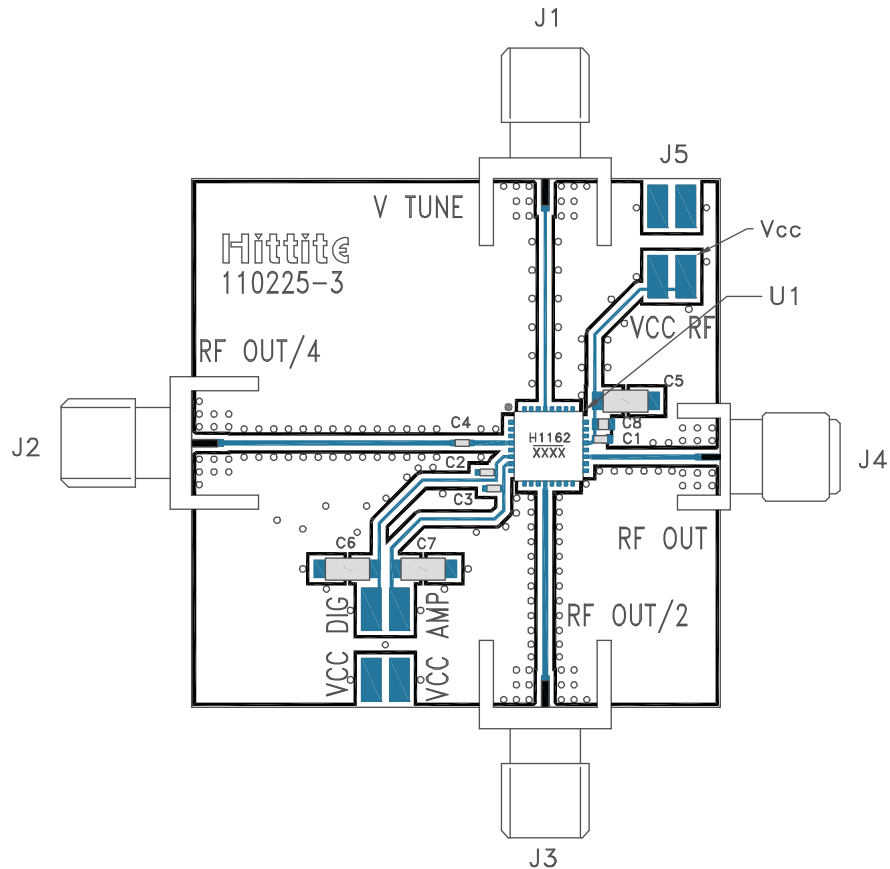

Figure 17. Evaluation Board

The circuit board used in an application uses RF circuit design techniques. Ensure that the signal lines have $50\ \Omega$ impedance and that the package ground leads and backside ground paddle are connected directly to the ground plane.

Use a sufficient number of via holes to connect the top and bottom ground planes. The evaluation circuit board shown in Figure 17 is available from Analog Devices, Inc., upon request.

BILL OF MATERIALS

Table 4. Bill of Materials [EV1HMC1162LP5](#)

Item	Description
J1 to J4	PCB mount SMA RF connectors
J5, J6	2 mm dc headers
C1 to C3	100 pF capacitors, 0402 package
C4	1000 pF capacitor, 0402 package
C5 to C7	2.2 μ F tantalum capacitors
C8	0.01 μ F capacitor, 0603 package
U1	HMC1162 VCO
PCB ¹	EV1HMC1162LP5 evaluation board ²

¹ Circuit board material is Rogers 4350.

² Reference this number when ordering the complete evaluation PCB.

PACKAGING AND ORDERING INFORMATION

OUTLINE DIMENSIONS

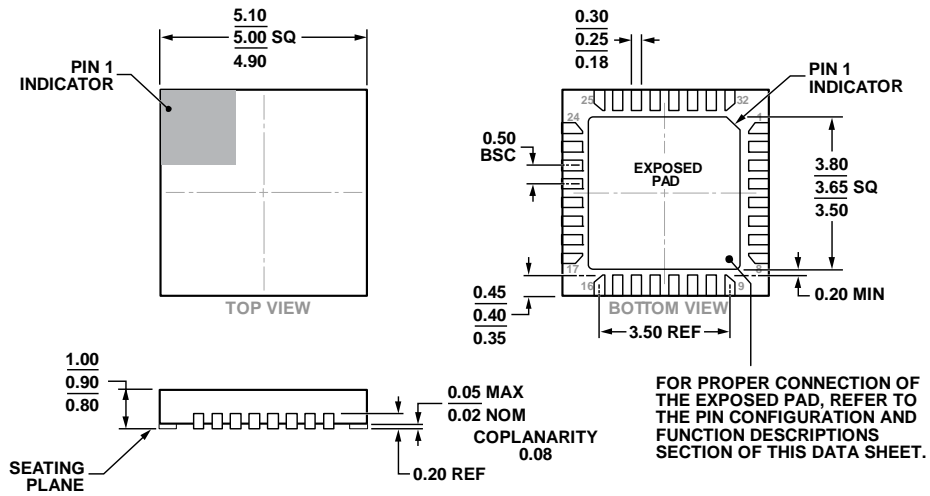

COMPLIANT TO JEDEC STANDARDS MO-220-VHHD-4.

Figure 18. 32-Lead Lead Frame Chip Scale Package [LFCSP_VQ]
5 mm × 5 mm Body, Very Thin Quad
(HCP-32-1)
Dimensions shown in millimeters

ORDERING GUIDE

Model ¹	Temperature Range	MSL Rating ²	Package Description	Package Option	Qty.	Brand ³
HMC1162LP5E	-40°C to +85°C	MSL3	32-Lead LFCSP_VQ	HCP-32-1		H1162 XXXX
HMC1162LP5ETR	-40°C to +85°C	MSL3	32-Lead LFCSP_VQ, 7" Tape and Reel	HCP-32-1	500	H1162 XXXX
EV1HMC1162LP5			Evaluation Board			

¹ The HMC1162LP5E and HMC1162LP5ETR are RoHS compliant parts.

² See the Absolute Maximum Ratings section, Table 2.

³ XXXX is a placeholder for the 4-digit lot number.