

HBT GAIN BLOCK MMIC AMPLIFIER, 7 - 15 GHz

Typical Applications

The HMC3653LP3BE is ideal for:

- Point-to-Point Radios
- Point-to-Multipoint Radios
- VSAT
- LO Driver for HMC Mixers
- Military EW & ECM

Functional Diagram

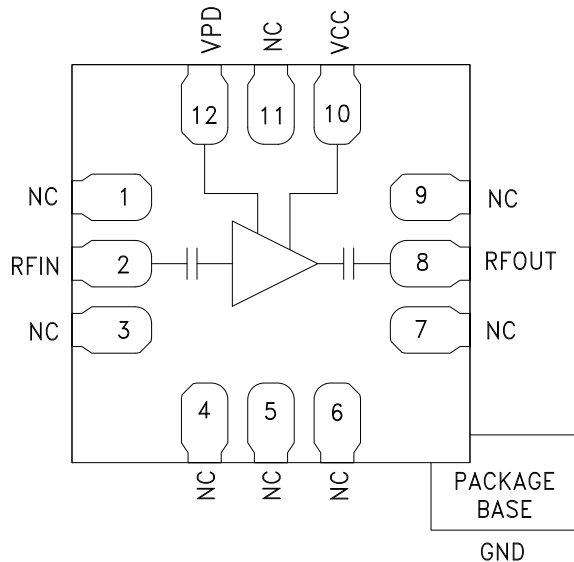

Features

- High Output IP3: +28 dBm
- Single Positive Supply: +5V
- Low Noise Figure: 4.0 dB ^[1]
- 12 Lead 3x3 mm SMT Package: 9mm²

General Description

The HMC3653LP3BE is a HBT Gain Block MMIC amplifier covering 7 GHz to 15 GHz and packaged in a 3x3 mm plastic QFN SMT package. This versatile amplifier can be used as a cascadable IF or RF gain stage in 50 Ohm applications. The HMC3653LP3BE delivers 15 dB gain, and +15 dBm output P1dB with only 4 dB noise figure.

Electrical Specifications, $T_A = +25^\circ\text{C}$, $V_{cc} = 5\text{V}$, $V_{pd} = 5\text{V}$

Parameter	Min.	Typ.	Max.	Min.	Typ.	Max.	Min.	Typ.	Max.	Units
Frequency Range	7 - 9		9 - 14		14 - 15					
Gain ^[1]	10.5	14		12	15		12	15		dB
Gain Variation Over Temperature		0.016			0.016			0.022		dB / °C
Input Return Loss		14			15			11		dB
Output Return Loss		8			8			7		dB
Output Power for 1 dB Compression (P1dB) ^[1]	13	16		12	15		10.5	13.5		dBm
Output Third Order Intercept (IP3) (Pout = 0 dBm per tone, 1 MHz spacing)		26			28			26		dBm
Noise Figure ^[1]		6			4			4		dB
I _{cc} (V _{pd} = 5V)		40	55		40	55		40	55	mA
I _{cc} (V _{pd} = 0V)		4	6		4	6		4	6	mA

[1] Board loss subtracted out

HMC3653* PRODUCT PAGE QUICK LINKS

Last Content Update: 09/23/2017

COMPARABLE PARTS

View a parametric search of comparable parts.

EVALUATION KITS

- HMC3653LP3B Evaluation Board

DOCUMENTATION

Application Notes

- AN-1363: Meeting Biasing Requirements of Externally Biased RF/Microwave Amplifiers with Active Bias Controllers

Data Sheet

- HMC3653: HBT Gain Block MMIC Amplifier, 7 - 15 GHz Data Sheet

TOOLS AND SIMULATIONS

- HMC3653 S-Parameter

REFERENCE MATERIALS

Quality Documentation

- Package/Assembly Qualification Test Report: LP2, LP2C, LP3, LP3B, LP3C, LP3D, LP3F, LP3G (QTR: 2014-0364)
- Semiconductor Qualification Test Report: GaAs HBT-A (QTR: 2013-00228)

DESIGN RESOURCES

- HMC3653 Material Declaration
- PCN-PDN Information
- Quality And Reliability
- Symbols and Footprints

DISCUSSIONS

View all HMC3653 EngineerZone Discussions.

SAMPLE AND BUY

Visit the product page to see pricing options.

TECHNICAL SUPPORT

Submit a technical question or find your regional support number.

DOCUMENT FEEDBACK

Submit feedback for this data sheet.

**HBT GAIN BLOCK
MMIC AMPLIFIER, 7 - 15 GHz**

Gain & Return Loss

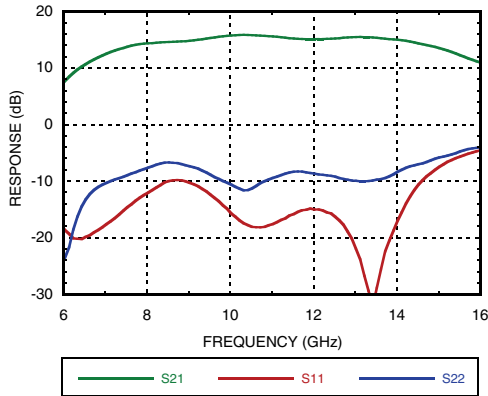

Gain vs. Temperature

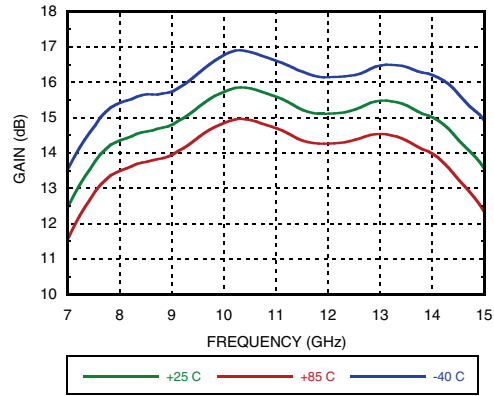

Input Return Loss vs. Temperature

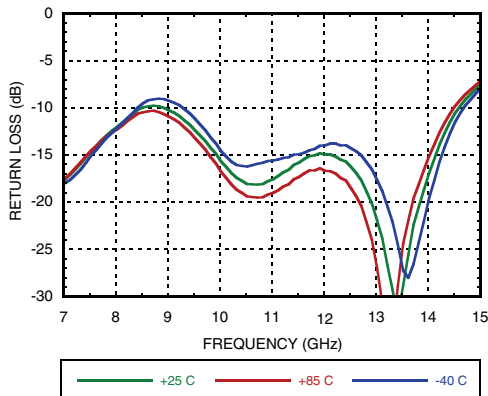

Output Return Loss vs. Temperature

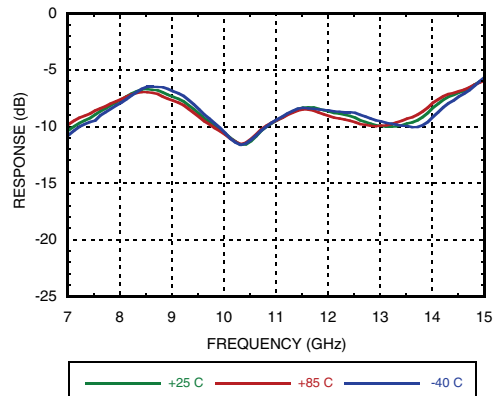

Noise Figure vs. Temperature

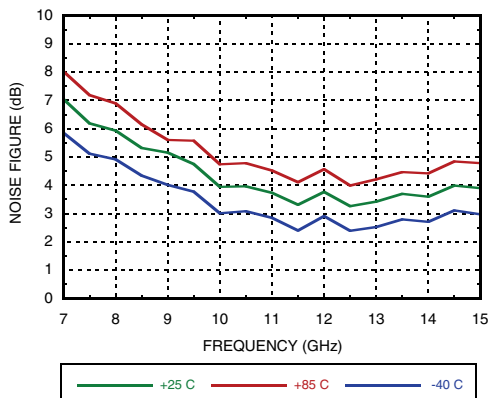

P1dB vs. Temperature

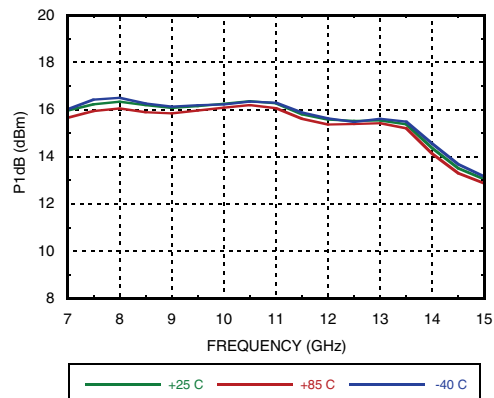

**HBT GAIN BLOCK
MMIC AMPLIFIER, 7 - 15 GHz**

Psat vs. Temperature

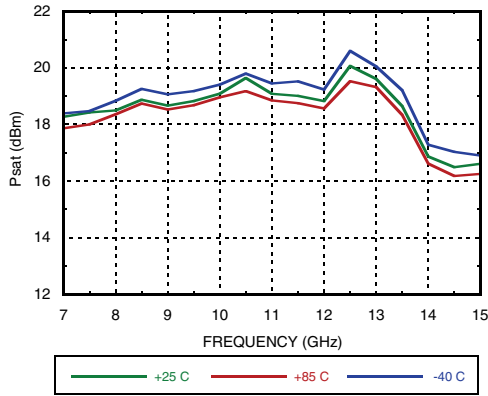

Output IP3 vs Temperature

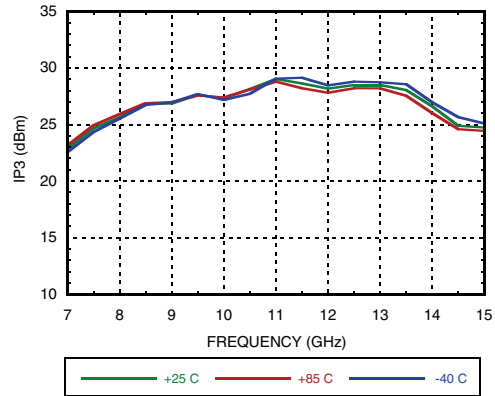

Phase Noise @ Pin=0 dBm

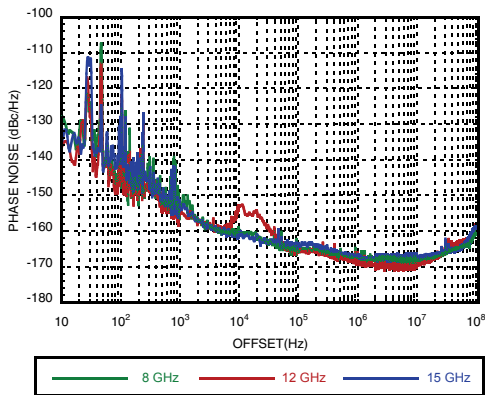

Power Compression @ 8 GHz

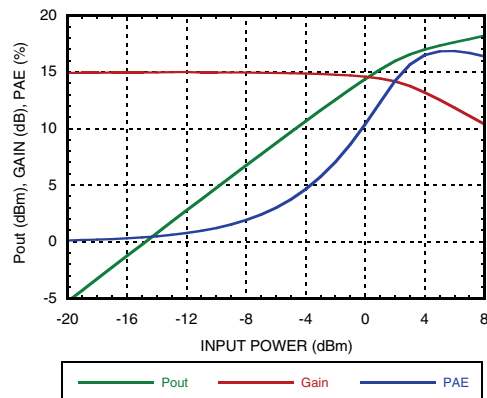

Power Compression @ 11 GHz

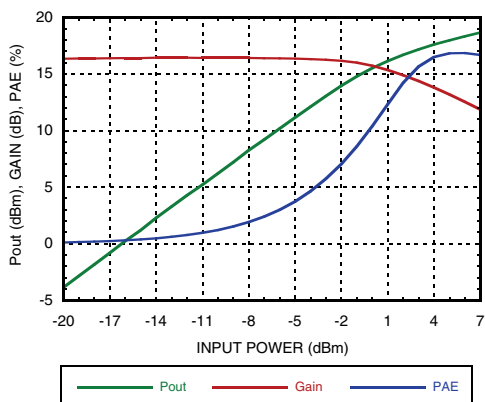

Power Compression @ 14 GHz

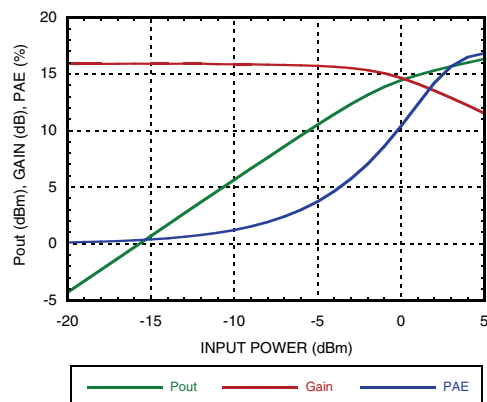

HBT GAIN BLOCK MMIC AMPLIFIER, 7 - 15 GHz

Reverse Isolation

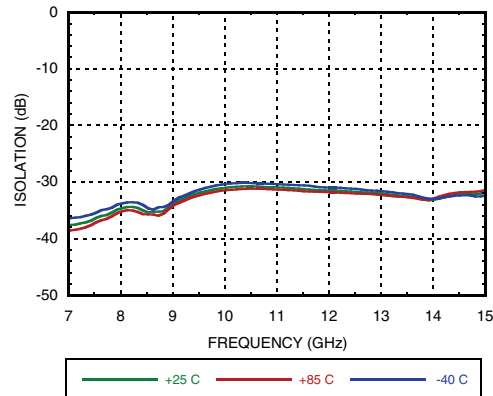

Absolute Maximum Ratings

Drain Bias Voltage	6 Vdc
RF Input Power (RFIN)	+12 dBm
Channel Temperature	150 °C
Continuous P _{diss} (T=85 °C) (derate 7.87 mW/ °C Above +85 °C)	512 mW
Thermal Resistance (channel to ground paddle)	127 °C/W
Storage Temperature	-65 to 150 °C
Operating Temperature	-40 to +85 °C
ESD Sensitivity (HBM)	Class 1A



ELECTROSTATIC SENSITIVE DEVICE
OBSERVE HANDLING PRECAUTIONS

HBT GAIN BLOCK MMIC AMPLIFIER, 7 - 15 GHz

Outline Drawing

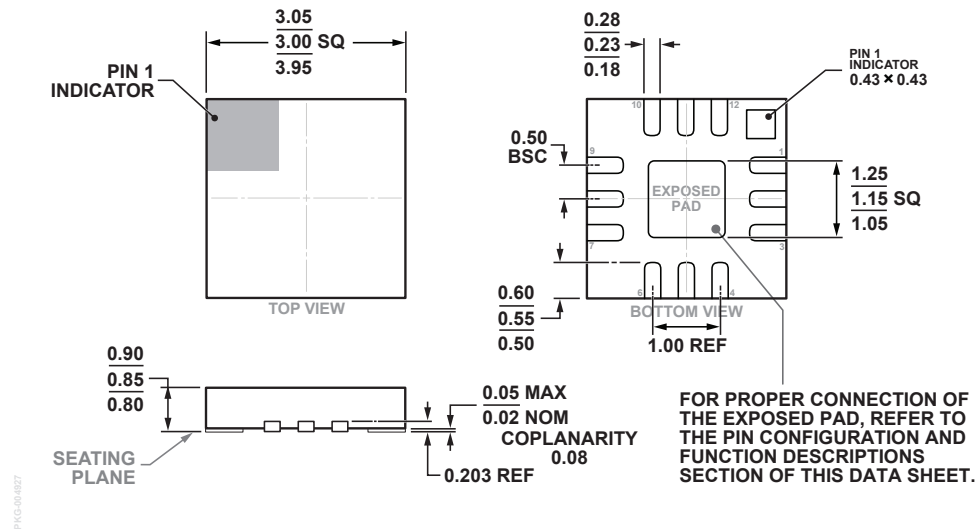

12-Lead Lead Frame Chip Scale Package [LFCSP]
3 mm × 3 mm Body and 0.85 mm Package Height
(CP-12-10)

Dimensions shown in millimeters

Package Information

Part Number	Package Body Material	Lead Finish	MSL Rating [2]	Package Marking [1]
HMC3653LP3BE	RoHS-compliant Low Stress Injection Molded Plastic	100% matte Sn	MSL1	H3653 XXXX

[1] 4-Digit lot number XXXX

[2] Max peak reflow temperature of 260 °C

HBT GAIN BLOCK MMIC AMPLIFIER, 7 - 15 GHz

Pin Descriptions

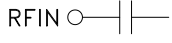
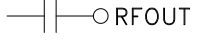
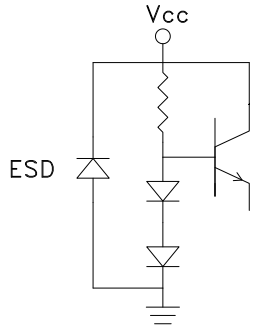
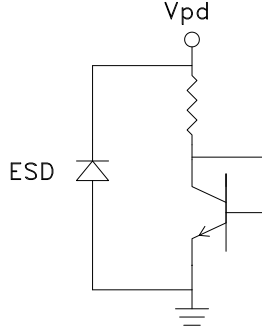
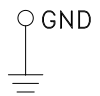
Pid Number	Function	Description	Interface Schematic
1, 3, 4, 5, 6, 7, 9, 11	NC	No connection necessary. These pins may be connected to RF/DC ground. Performance will not be affected.	
2	RFIN	This pin is AC coupled and matched to 50 Ohms.	RFIN 
8	RFOUT	This pin is AC coupled and matched to 50 Ohms.	 RFOUT
10	Vcc	Power supply voltage for the amplifier	
12	Vpd	Power Control Pin for proper control bias	
GND Paddle	GND	Ground Paddle must be connected to RF/DC ground.	

**HBT GAIN BLOCK
MMIC AMPLIFIER, 7 - 15 GHz**

Application Circuit

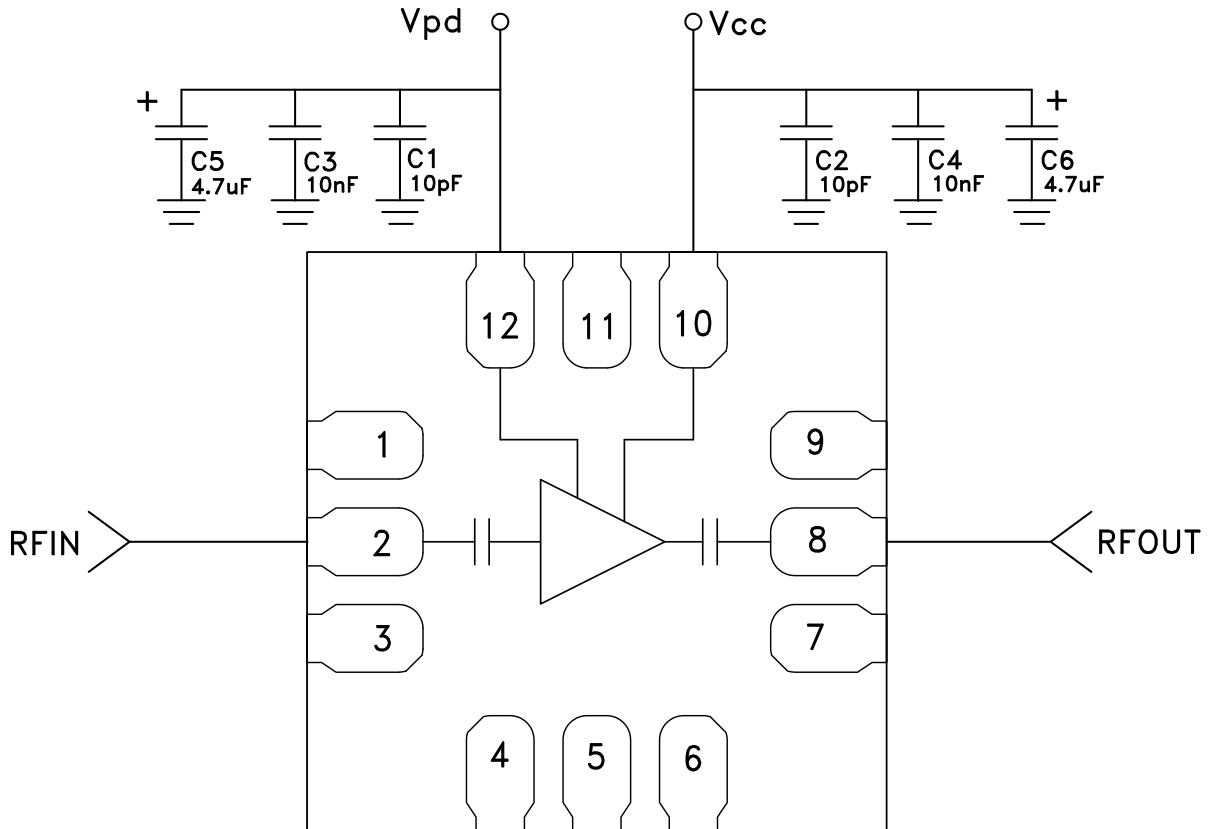

HBT GAIN BLOCK MMIC AMPLIFIER, 7 - 15 GHz

Evaluation PCB

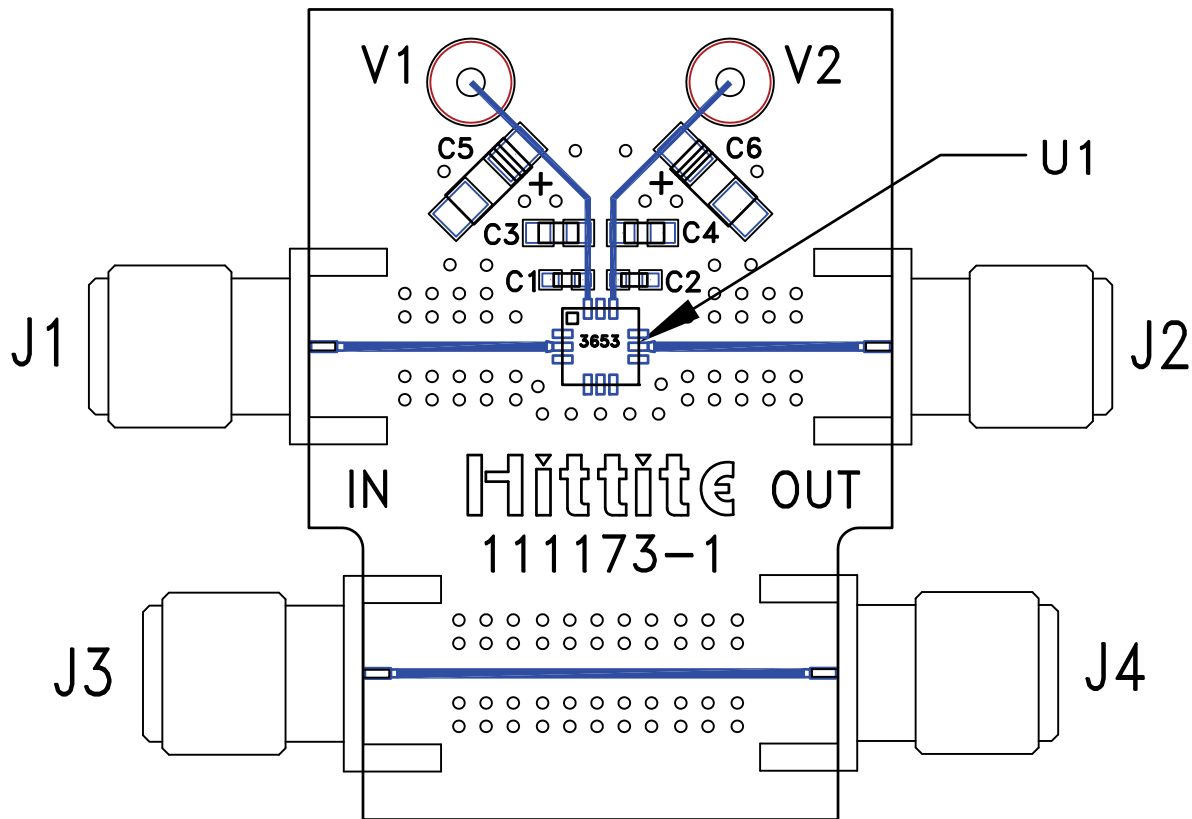

List of Material for Evaluation PCB 113589-HMC3653LP3B- rev D ^[1]

Item	Description
J1, J4	PCB Mount SMA RF Connector
C1 - C2	10 pF Capacitor, 0402 Pkg.
C3 - C4	10000 pF Capacitor, 0603 Pkg.
C5 - C6	4.7 uF Capacitor, Tantalum.
U1	HMC3653LP3BE
PCB ^[2]	111173-1 Evaluation Board

^[1] Reference this number when ordering complete evaluation PCB

^[2] Circuit Board Material: Rogers 4350 or Arlon 25FR

The circuit board used in the application should use RF circuit design techniques. Signal lines should have 50 Ohm impedance while the package ground leads and exposed paddle should be connected directly to the ground plane similar to that shown. A sufficient number of via holes should be used to connect the top and bottom ground planes. The evaluation circuit board shown is available from Analog Devices upon request.