



FEATURES

- Receive path includes dual 12-bit, 50 MSPS analog-to-digital converters with internal or external reference
- Transmit path includes dual 12-bit, 200 MSPS digital-to-analog converters with 1×, 2×, or 4× interpolation and programmable gain control
- Internal clock distribution block includes a programmable phase-locked loop and timing generation circuitry, allowing single-reference clock operation
- 24-pin flexible I/O data interface allows various interleaved or noninterleaved data transfers in half-duplex mode and interleaved data transfers in full-duplex mode
- Configurable through register programmability or optionally limited programmability through mode pins
- Independent Rx and Tx power-down control pins
- 64-lead LFCSP package (9 mm × 9 mm footprint)

APPLICATIONS

- Broadband access
- Broadband LAN
- Communications (modems)

GENERAL DESCRIPTION

The AD9863 is a member of the MxFE family—a group of integrated converters for the communications market. The AD9863 integrates dual 12-bit analog-to-digital converters (ADC) and dual 12-bit digital-to-analog converters (TxDAC®). The AD9863 ADCs are optimized for ADC sampling of 50 MSPS and less. The dual TxDACs operate at speeds up to 200 MHz and include a bypassable 2× or 4× interpolation filter. The AD9863 is optimized for high performance, low power, and small form factor to provide a cost-effective solution for the broadband communications market.

The AD9863 uses a single input clock pin (CLKIN) or two independent clocks for the Tx path and the Rx path. The ADC and TxDAC clocks are generated within a timing generation block that provides user programmable options such as divide circuits, PLL multipliers, and switches.

A flexible, bidirectional 24-bit I/O bus accommodates a variety of custom digital back ends or open market DSPs.

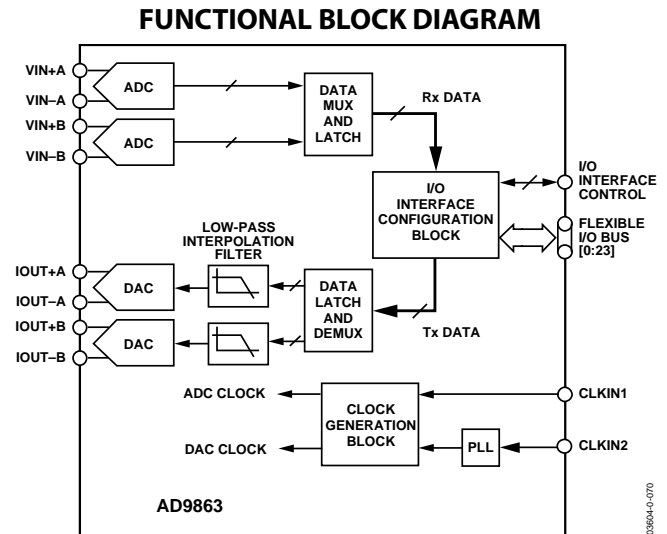

Figure 1.

In half-duplex systems, the interface supports 24-bit parallel transfers or 12-bit interleaved transfers. In full-duplex systems, the interface supports a 12-bit interleaved ADC bus and a 12-bit interleaved TxDAC bus. The flexible I/O bus reduces pin count, also reducing the required package size on the AD9863 and the device to which it connects.

The AD9863 can use either mode pins or a serial programmable interface (SPI) to configure the interface bus, operate the ADC in a low power mode, configure the TxDAC interpolation rate, and control ADC and TxDAC power-down. The SPI provides more programmable options for both the TxDAC path (for example, coarse and fine gain control and offset control for channel matching) and the ADC path (for example, the internal duty cycle stabilizer and twos complement data format).

The AD9863 is packaged in a 64-lead LFCSP (low profile, fine pitched, chip scale package). The 64-lead LFCSP footprint is only 9 mm × 9 mm and is less than 0.9 mm high, fitting into such tightly spaced applications as PCMCIA cards.

AD9863* PRODUCT PAGE QUICK LINKS

Last Content Update: 06/30/2017

COMPARABLE PARTS

View a parametric search of comparable parts.

EVALUATION KITS

- AD-DAC-FMC-ADP
- AD9861/AD9863 Evaluation Tools

DOCUMENTATION

Application Notes

- AN-808: Multicarrier CDMA2000 Feasibility
- AN-851: A WiMax Double Downconversion IF Sampling Receiver Design
- AN-928: Understanding High Speed DAC Testing and Evaluation

Data Sheet

- AD9863 12-Bit Mixed-Signal Front-End (MxFE™) Baseband Transceiver For Broadband Applications Data Sheet

TOOLS AND SIMULATIONS

- AD9863 IBIS Models

REFERENCE MATERIALS

Informational

- Advantiv™ Advanced TV Solutions

Technical Articles

- MS-2210: Designing Power Supplies for High Speed ADC

DESIGN RESOURCES

- AD9863 Material Declaration
- PCN-PDN Information
- Quality And Reliability
- Symbols and Footprints

DISCUSSIONS

View all AD9863 EngineerZone Discussions.

SAMPLE AND BUY

Visit the product page to see pricing options.

TECHNICAL SUPPORT

Submit a technical question or find your regional support number.

DOCUMENT FEEDBACK

Submit feedback for this data sheet.

TABLE OF CONTENTS

Features	1	Pin Configuration and Function Descriptions.....	8
Applications.....	1	Typical Performance Characteristics	10
Functional Block Diagram	1	Terminology	17
General Description	1	Theory of Operation	18
Revision History	2	System Block	18
Tx Path Specifications.....	3	Rx Path Block.....	18
Rx Path Specifications.....	4	Tx Path Block.....	20
Power Specifications.....	5	Digital Block.....	23
Digital Specifications.....	5	Programmable Registers.....	33
Timing Specifications.....	6	Clock Distribution Block	36
Absolute Maximum Ratings.....	7	Outline Dimensions	40
Thermal Resistance	7	Ordering Guide	40
ESD Caution.....	7		

REVISION HISTORY

4/2017—Rev. A to Rev. B

Changes to Figure 3 and Table 8.....	8
Updated Outline Dimensions	42
Changes to Ordering Guide	42

4/2005—Rev. 0 to Rev. A

Changes to Ordering Guide	40
---------------------------------	----

11/2003—Revision 0: Initial Version

Tx PATH SPECIFICATIONS

FDAC = 200 MSPS; 4× interpolation; RSET = 4.02 kΩ; differential load resistance of 100 Ω¹; TxPGA = 20 dB; AVDD = DVDD = 3.3 V, unless otherwise noted.

Table 1.

Parameter	Temp	Test Level	Min	Typ	Max	Unit
Tx PATH GENERAL						
Resolution	Full	IV		12		Bits
Maximum DAC Update Rate	Full	IV	200			MHz
Maximum Full-Scale Output Current	Full	IV	20			mA
Full-Scale Error	Full	V		1%		
Gain Mismatch Error	25°C	IV	-3.5		+3.5	% FS
Offset Mismatch Error	Full	IV	-0.1		+0.1	% FS
Reference Voltage	Full	V		1.23		V
Output Capacitance	Full	V		5		pF
Phase Noise (1 kHz Offset, 6 MHz Tone)	25°C	V		-115		dBc/Hz
Output Voltage Compliance Range	Full	IV	-1.0		+1.0	V
TxPGA Gain Range	Full	V		20		dB
TxPGA Step Size	Full	V		0.10		dB
Tx PATH DYNAMIC PERFORMANCE (I _{OUTFS} = 20 mA; F _{OUT} = 1 MHz)						
SNR	Full	IV	70.8	71.6		dB
SINAD	Full	IV	64.3	71		dB
THD	Full	IV		-79	-66.3	dBc
SFDR, Wide Band (DC to Nyquist)	Full	IV	68.5	77		dBc
SFDR, Narrow Band (1 MHz Window)	Full	IV	72.8	81		dBc

¹ See Figure 2 for description of the TxDAC termination scheme.

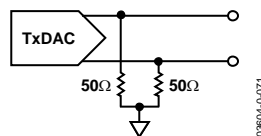

Figure 2. Diagram Showing Termination of 100 Ω Differential Load for Some TxDAC Measurements

RX PATH SPECIFICATIONS

$F_{ADC} = 50$ MSPS; internal reference; differential analog inputs, $ADC_AVDD = DVDD = 3.3$ V, unless otherwise noted.

Table 2.

Parameter	Temp	Test Level	Min	Typ	Max	Unit
Rx PATH GENERAL						
Resolution	Full	V		12		Bits
Maximum ADC Sample Rate	Full	IV	50			MSPS
Gain Mismatch Error	Full	V		± 0.2		% FS
Offset Mismatch Error	Full	V		± 0.1		% FS
Reference Voltage	Full	V		1.0		V
Reference Voltage (REFT-REFB) Error	Full	IV	-30	± 6	+30	mV
Input Resistance (Differential)	Full	V		2		k Ω
Input Capacitance	Full	V		5		pF
Input Bandwidth	Full	V		30		MHz
Differential Analog Input Voltage Range	Full	V		2		V p-p differential
Rx PATH DC ACCURACY						
Integral Nonlinearity (INL)	25°C	V		± 0.75		LSB
Differential Nonlinearity (DNL)	25°C	V		± 0.75		LSB
Aperture Delay	25°C	V		2.0		ns
Aperture Uncertainty (Jitter)	25°C	V		1.2		ps rms
Input Referred Noise	25°C	V		250		μ V
AD9863 Rx PATH DYNAMIC PERFORMANCE ($V_{IN} = -0.5$ dBFS; $F_{IN} = 10$ MHz)						
SNR	Full	V		67		dBc
SINAD	Full	V		65.5		dBc
THD (Second to Ninth Harmonics)	Full	IV		-73	-66.6	dBc
SFDR, Wide Band (DC to Nyquist)	Full	IV	68.3	74		dBc
Crosstalk Between ADC Inputs	Full	V		80		dB

POWER SPECIFICATIONS

Analog and digital supplies = 3.3 V; $F_{CLKIN1} = F_{CLKIN2} = 50$ MHz; PLL 4× setting; normal timing mode.

Table 3.

Parameter	Temp	Test Level	Min	Typ	Max	Unit
POWER SUPPLY RANGE						
Analog Supply Voltage (AVDD)	Full	IV	2.7		3.6	V
Digital Supply Voltage (DVDD)	Full	IV	2.7		3.6	V
Driver Supply Voltage (DRVDD)	Full	IV	2.7		3.6	V
ANALOG SUPPLY CURRENTS						
Tx Path (20 mA Full-Scale Outputs)	Full	V		70		mA
Tx Path (2 mA Full-Scale Outputs)	Full	V		20		mA
Rx Path (50 MSPS)	Full	V		103		mA
Rx Path (50 MSPS, Low Power Mode)	Full	V		69		mA
Rx Path (20 MSPS, Low Power Mode)	Full	V		55		mA
Tx Path, Power-Down Mode	Full	V		2		mA
Rx Path, Power-Down Mode	Full	V		5		mA
PLL	Full	V		12		mA
DIGITAL SUPPLY CURRENTS						
Tx Path, 1× Interpolation, 50 MSPS DAC Update for Both DACs, Half-Duplex 24 Mode	Full	V		20		mA
Tx Path, 2× Interpolation, 100 MSPS DAC Update for Both DACs, Half-Duplex 24 Mode	Full	V		50		mA
Tx Path, 4× Interpolation, 200 MSPS DAC Update for Both DACs, Half-Duplex 24 Mode	Full	V		80		mA
Rx Path Digital, Half-Duplex 24 Mode	Full	V		15		mA

DIGITAL SPECIFICATIONS

Table 4.

Parameter	Temp	Test Level	Min	Typ	Max	Unit
LOGIC LEVELS						
Input Logic High Voltage, V_{IH}	Full	IV	DRVDD – 0.7			V
Input Logic Low Voltage, V_{IL}	Full	IV			0.4	V
Output Logic High Voltage, V_{OH} (1 mA Load)	Full	IV	DRVDD – 0.6			V
Output Logic Low Voltage, V_{OL} (1 mA Load)	Full	IV			0.4	V
DIGITAL PIN						
Input Leakage Current	Full	IV			12	μA
Input Capacitance	Full	IV		3		pF
Minimum RESET Low Pulse Width	Full	IV	5			Input clock cycles
Digital Output Rise/Fall Time	Full	IV	2.8		4	ns

TIMING SPECIFICATIONS

Table 5.

Parameter	Temp	Test Level	Min	Typ	Max	Unit
INPUT CLOCK						
CLKIN2 Clock Rate (PLL Bypassed)	Full	IV	1		200	MHz
PLL Input Frequency	Full	IV	16		200	MHz
PLL Output Frequency	Full	IV	32		350	MHz
TxPATH DATA						
Setup Time (HD24 Mode, Time Required Before Data Latching Edge)	Full	V		5		ns (see Clock Distribution Block section)
Hold Time (HD24 Mode, Time Required After Data Latching Edge)	Full	V		-1.5		ns (see Clock Distribution Block section)
Latency 1x Interpolation (Data In Until Peak Output Response)	Full	V		7		DAC clock cycles
Latency 2x Interpolation (Data In Until Peak Output Response)	Full	V		35		DAC clock cycles
Latency 4x Interpolation (Data In Until Peak Output Response)	Full	V		83		DAC clock cycles
RxPATH DATA						
Output Delay (HD24 Mode, t_{OD})	Full	V		-1.5		ns (see Clock Distribution Block section)
Latency	Full	V		5		ADC clock cycles

Table 6. Explanation of Test Levels

Level	Description
I	100% production tested.
II	100% production tested at 25°C and guaranteed by design and characterization at specified temperatures.
III	Sample tested only.
IV	Parameter is guaranteed by design and characterization testing.
V	Parameter is a typical value only.
VI	100% production tested at 25°C and guaranteed by design and characterization for industrial temperature range.

ABSOLUTE MAXIMUM RATINGS

Table 7.

Parameter	Rating
Electrical	
AVDD Voltage	3.9 V max
DRVDD Voltage	3.9 V max
Analog Input Voltage	-0.3 V to AVDD + 0.3 V
Digital Input Voltage	-0.3 V to DVDD - 0.3 V
Digital Output Current	5 mA max
Environmental	
Operating Temperature Range (Ambient)	-40°C to +85°C
Maximum Junction Temperature	150°C
Lead Temperature (Soldering, 10 sec)	300°C
Storage Temperature Range (Ambient)	-65°C to +150°C

THERMAL RESISTANCE

64-lead LFCSP (4-layer board):

$$\theta_{JA} = 24.2 \text{ (paddle soldered to ground plan, 0 LPM air)}$$

$$\theta_{JA} = 30.8 \text{ (paddle not soldered to ground plan, 0 LPM air)}$$

Stresses at or above those listed under Absolute Maximum Ratings may cause permanent damage to the product. This is a stress rating only; functional operation of the product at these or any other conditions above those indicated in the operational section of this specification is not implied. Operation beyond the maximum operating conditions for extended periods may affect product reliability.

ESD CAUTION



ESD (electrostatic discharge) sensitive device.

Charged devices and circuit boards can discharge without detection. Although this product features patented or proprietary protection circuitry, damage may occur on devices subjected to high energy ESD. Therefore, proper ESD precautions should be taken to avoid performance degradation or loss of functionality.

PIN CONFIGURATION AND FUNCTION DESCRIPTIONS

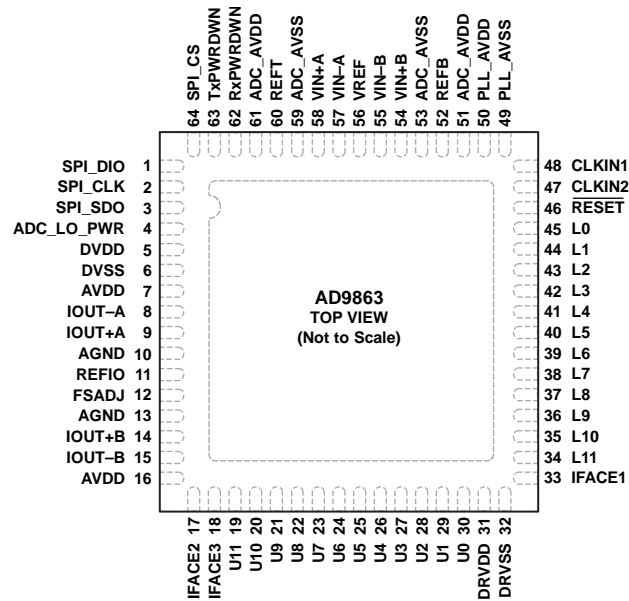

NOTES
1. EXPOSED PAD. THE EXPOSED PAD MUST BE SECURELY CONNECTED TO THE GROUND PLANE.

038604-0-072

Figure 3. Pin Configuration

Table 8. Pin Function Descriptions

Pin No.	Name ¹	Description ^{2,3}
1	SPI_DIO (Interp1)	SPI: Serial Port Data Input. No SPI: Tx Interpolation Pin, MSB.
2	SPI_CLK (Interp0)	SPI: Serial Port Shift Clock. No SPI: Tx Interpolation Pin, LSB.
3	SPI_SDO (FD/HD)	SPI: 4-Wire Serial Port Data Output. No SPI: Configures Full-Duplex or Half-Duplex Mode.
4	ADC_LO_PWR	ADC Low Power Mode Enable. Defined at power-up.
5, 31	DVDD, DRVDD	Digital Supply.
6, 32	DVSS, DRVDD	Digital Ground.
7, 16, 50, 51, 61	AVDD	Analog Supply.
8, 9	IOUT-A, IOUT+A	DAC A Differential Output.
10, 13, 49, 53, 59	AGND, AVSS	Analog Ground.
11	REFIO	Tx DAC Band Gap Reference Decoupling Pin.
12	FSADJ	Tx DAC Full-Scale Adjust Pin.
14, 15	IOUT+B, IOUT-B	DAC B Differential Output.
17	IFACE2 (12/24)	SPI: Buffered CLKIN. Can be configured as system clock output. No SPI: Buffered CLKIN for FD; 12/24 configuration pin for HD24 or HD12.
18	IFACE3	Clock Output.
19 to 30	U11 to U0	Upper Data Bit 11 to Upper Data Bit 0.
33	IFACE1	SPI: TxSYNC for FD; Tx/Rx for HD24, HD12, or clone. No SPI: FD >> TxSYNC; HD24 or HD12: Tx/Rx. Clone mode requires a serial port interface.
34 to 45	L11 to L0	Lower Data Bit 11 to Lower Data Bit 0.
46	RESET	Chip Reset When Low.
47	CLKIN2	Clock Input 2.
48	CLKIN1	Clock Input 1.
52	REFB	ADC Bottom Reference.
54, 55	VIN+B, VIN-B	ADC B Differential Input.

Pin No.	Name ¹	Description ^{2,3}
56	VREF	ADC Band Gap Reference.
57, 58	VIN–A, VIN+A	ADC A Differential Input.
60	REFT	ADC Top Reference.
62	RxPWRDWN	Rx Analog Power-Down Control.
63	TxPWRDWN	Tx Analog Power-Down Control.
64	SPI_CS	SPI: Serial Port Chip Select. At power-up or reset, this must be high. No SPI: Tie low to disable SPI and use mode pins. This pin must be tied low.
	EPAD	Exposed Pad. The exposed pad must be securely connected to the ground plane.

¹ Underlined pin names and descriptions apply when the device is configured without a serial port interface, referred to as No SPI mode.

² Some pin descriptions depend on whether a serial port is used (SPI mode) or not (No SPI mode), indicated by the labels SPI and No SPI.

³ Some pin descriptions depend on the interface configuration: full-duplex (FD), half-duplex interleaved data (HD12), half-duplex parallel data (HD24), and a half-duplex interface similar to the AD9860 and AD9862 data interface called clone mode (Clone). Clone mode requires a serial port interface.

TYPICAL PERFORMANCE CHARACTERISTICS

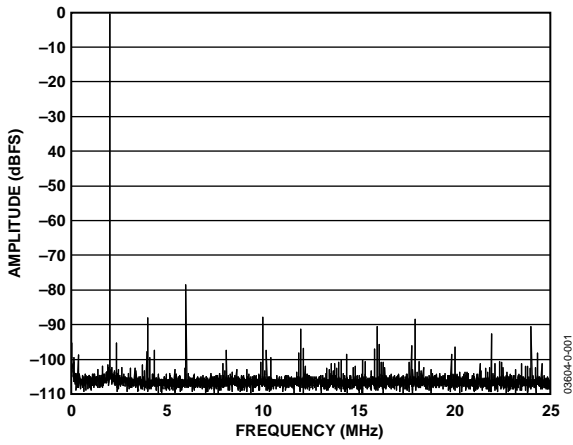

Figure 4. AD9863 Rx Path Single-Tone FFT of Rx Channel B Path Digitizing 2 MHz Tone

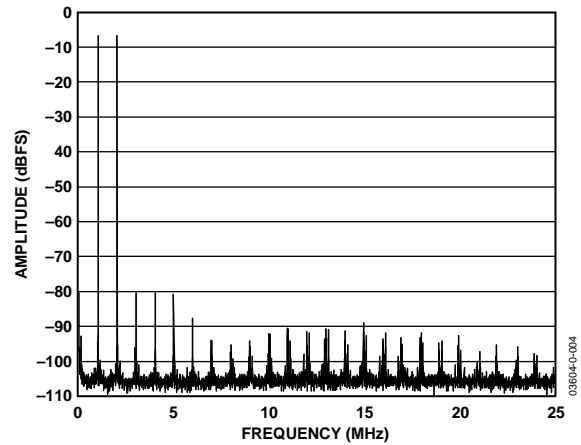

Figure 7. AD9863 Rx Path Dual-Tone FFT of Rx Channel A Path Digitizing 1 MHz and 2 MHz Tones

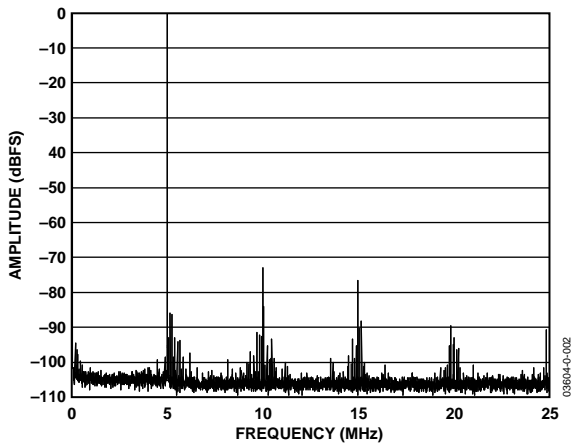

Figure 5. AD9863 Rx Path Single-Tone FFT of Rx Channel B Path Digitizing 5 MHz Tone

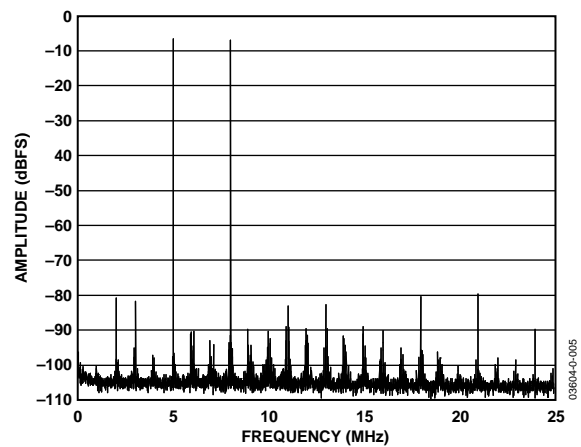

Figure 8. AD9863 Rx Path Dual-Tone FFT of Rx Channel A Path Digitizing 5 MHz and 8 MHz Tones

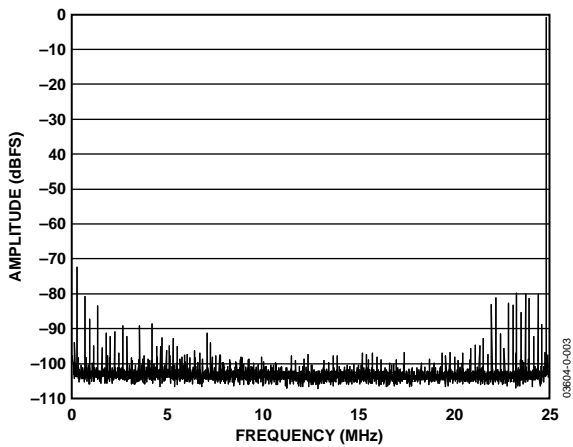

Figure 6. AD9863 Rx Path Single-Tone FFT of Rx Channel B Path Digitizing 24 MHz Tone

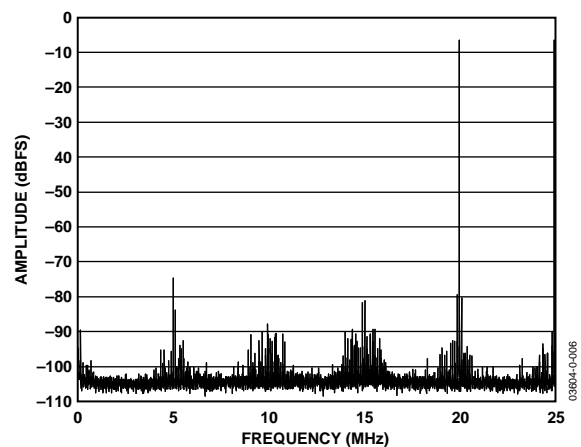

Figure 9. AD9863 Rx Path Dual-Tone FFT of Rx Channel A Path Digitizing 20 MHz and 25 MHz Tones

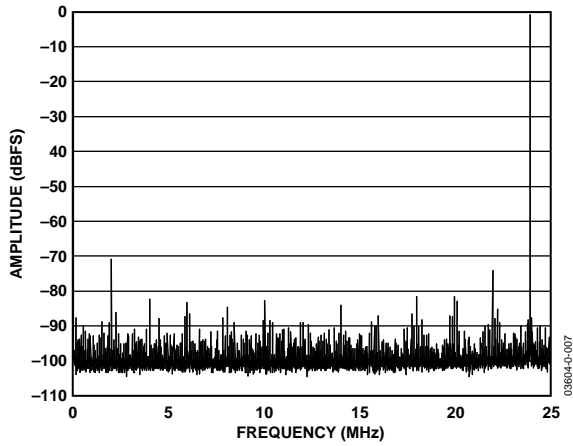

Figure 10. AD9863 Rx Path Single-Tone FFT of Rx Channel B Path Digitizing 76 MHz Tone

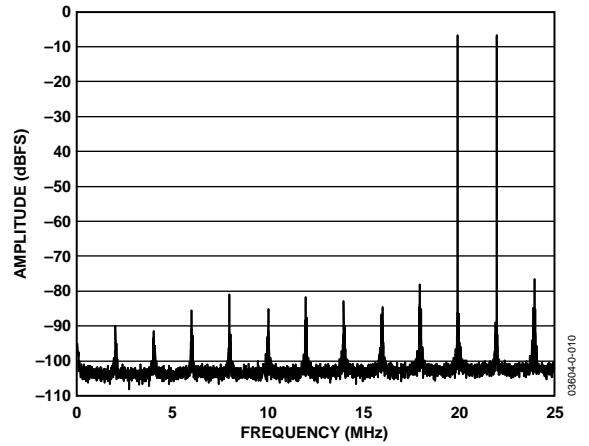

Figure 13. AD9863 Rx Path Dual-Tone FFT of Rx Channel A Path Digitizing 70 MHz and 72 MHz Tones

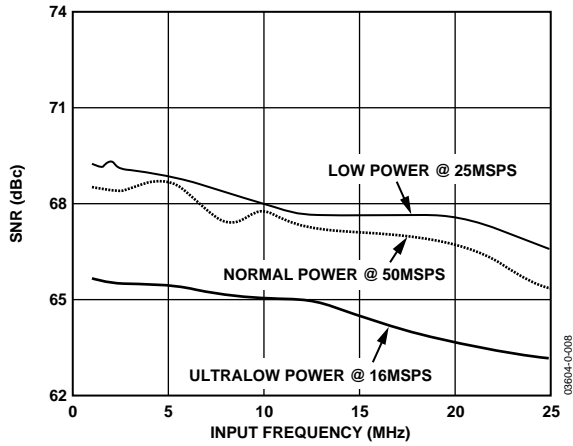

Figure 11. AD9863 Rx Path at 50 MSPS, 10 MHz Input Tone SNR Performance vs. Input Frequency

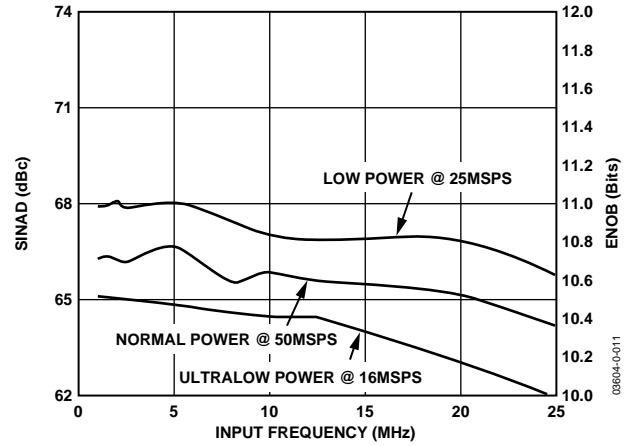

Figure 14. AD9863 Rx Path at 50 MSPS, 10 MHz Input Tone SINAD Performance vs. Input Frequency

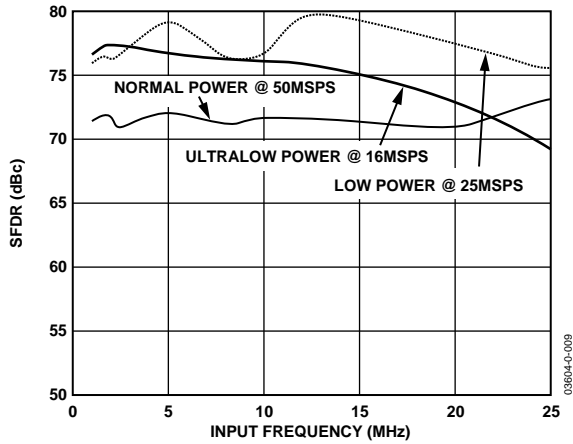

Figure 12. AD9863 Rx Path at 50 MSPS, 10 MHz Input Tone SFDR Performance vs. Input Frequency

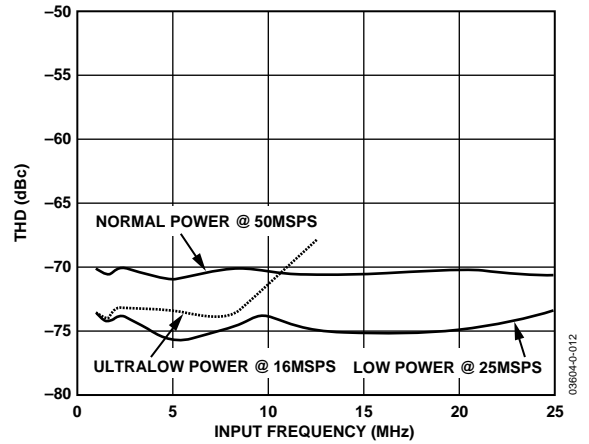

Figure 15. AD9863 Rx Path at 50 MSPS, 10 MHz Input Tone THD Performance vs. Input Frequency

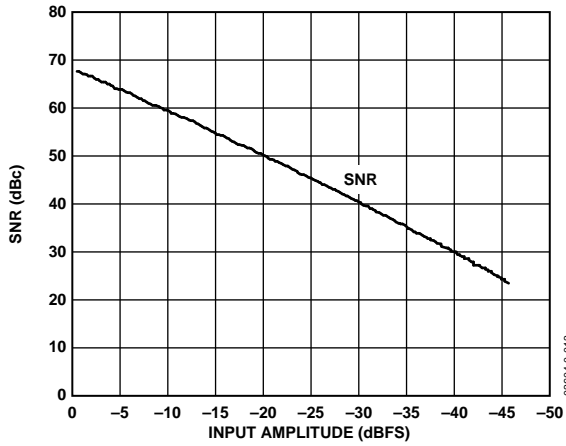

Figure 16. AD9863 Rx Path at 50 MSPS, 10 MHz Input Tone SNR Performance vs. Input Amplitude

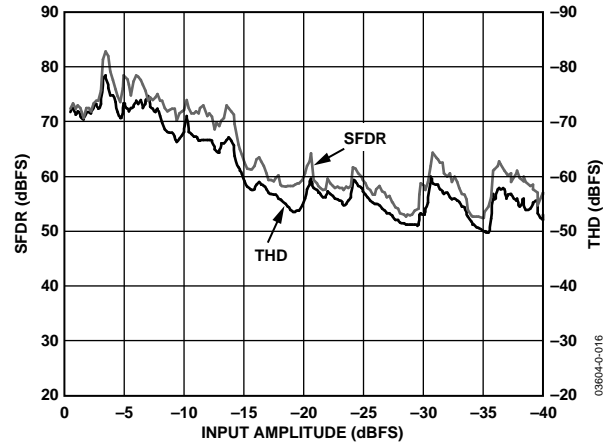

Figure 19. AD9863 Rx Path at 50 MSPS, 10 MHz Input Tone THD and SFDR Performance vs. Input Amplitude

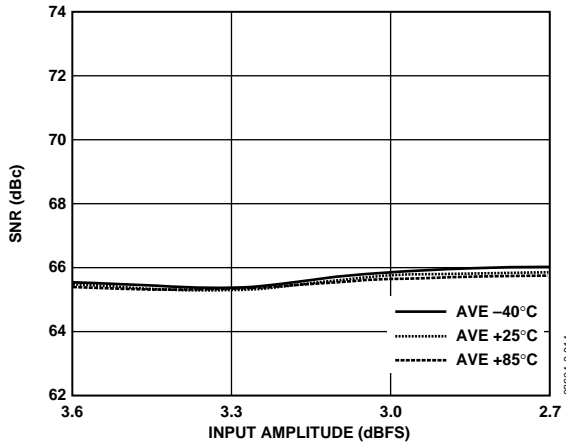

Figure 17. AD9863 Rx Path at 50 MSPS, 10 MHz Input Tone SNR Performance vs. ADC_AVDD and Temperature

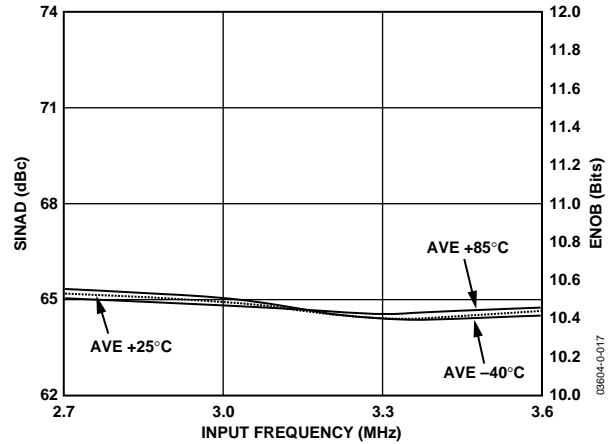

Figure 20. AD9863 Rx Path at 50 MSPS, 10 MHz Input Tone SINAD Performance vs. ADC_AVDD and Temperature

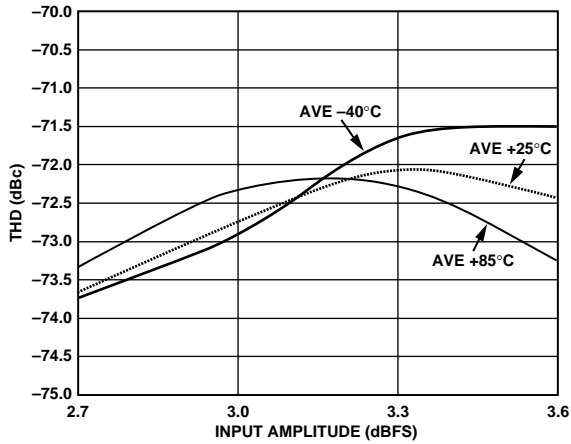

Figure 18. AD9863 Rx Path Single-Tone THD Performance vs. ADC_AVDD and Temperature

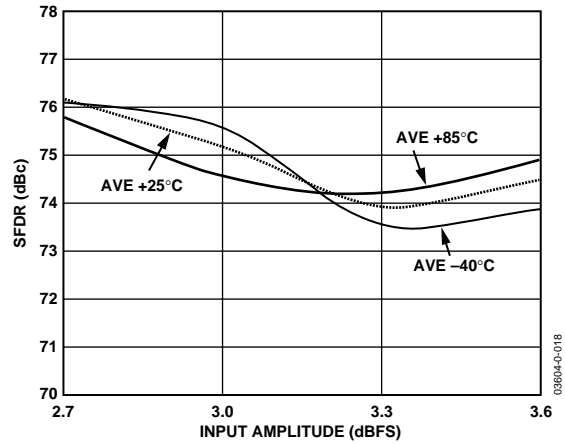

Figure 21. AD9863 Rx Path Single-Tone SFDR Performance vs. ADC_AVDD and Temperature

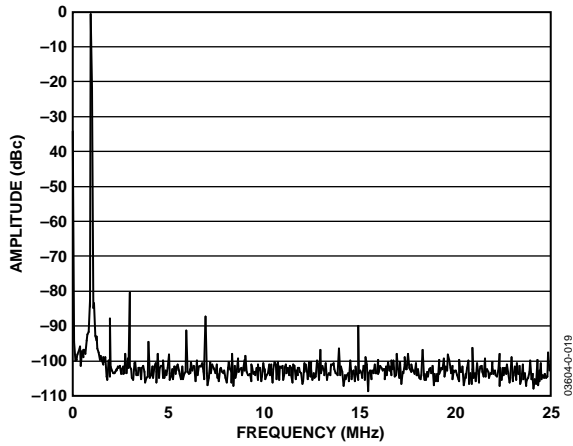

Figure 22. AD9863 Tx Path 1 MHz Single-Tone Output FFT of Tx Path with 20 mA Full-Scale Output into 33 Ω Differential Load

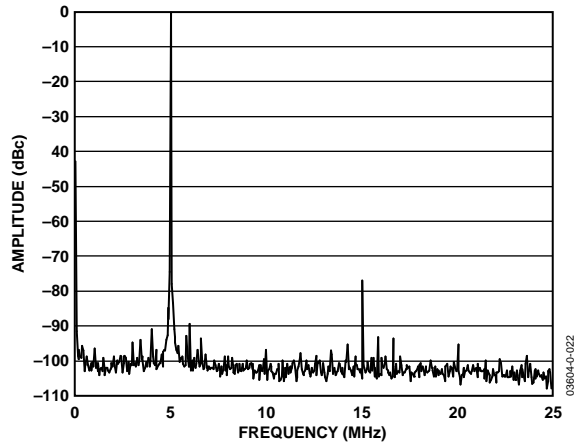

Figure 25. AD9863 Tx Path 5 MHz Single-Tone Output FFT of Tx Channel A with 20 mA Full-Scale Output into 33 Ω Differential Load

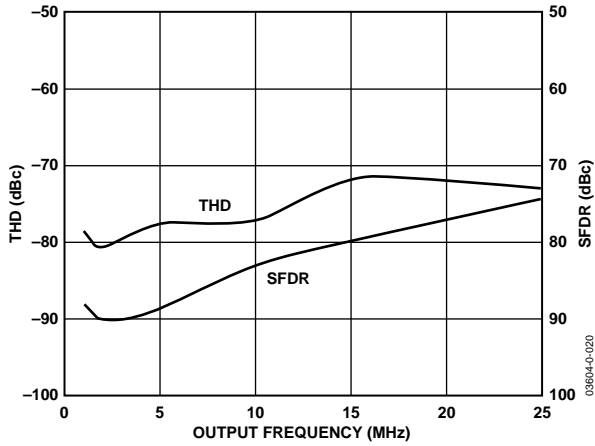

Figure 23. AD9863 Tx Path THD/SFDR vs. Output Frequency of Tx Channel A, with 20 mA Full-Scale Output into 60 Ω Differential Load

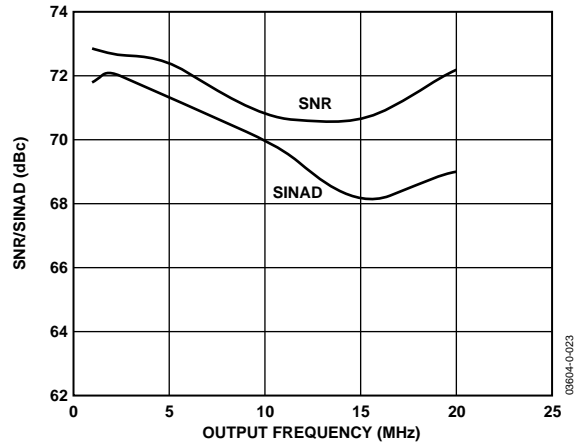

Figure 26. AD9863 Tx Path SINAD/SNR vs. Output Frequency of Tx Path with 20 mA Full-Scale Output into 60 Ω Differential Load

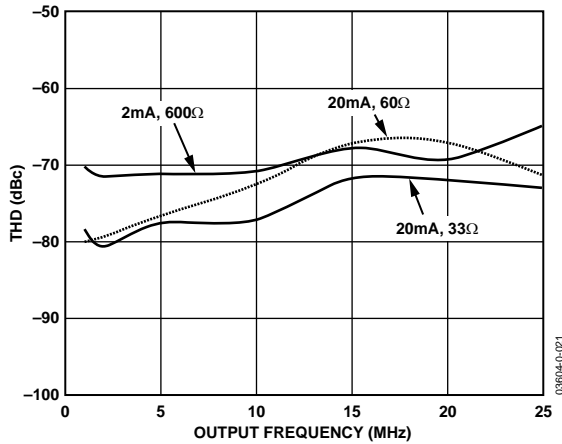

Figure 24. AD9863 Tx Path THD vs. Output Frequency of Tx Channel A

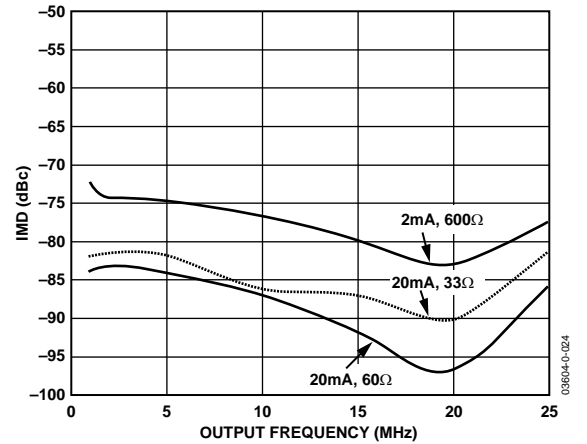

Figure 27. AD9863 Tx Path Dual-Tone (0.5 MHz Spacing) IMD vs. Output Frequency

Figure 28 to Figure 33 use the same input data to the Tx path, a 64-carrier OFDM signal over a 20 MHz bandwidth, centered at 20 MHz. The two center carriers are removed from the signal to observe the in-band intermodulation distortion (IMD) from the DAC output.

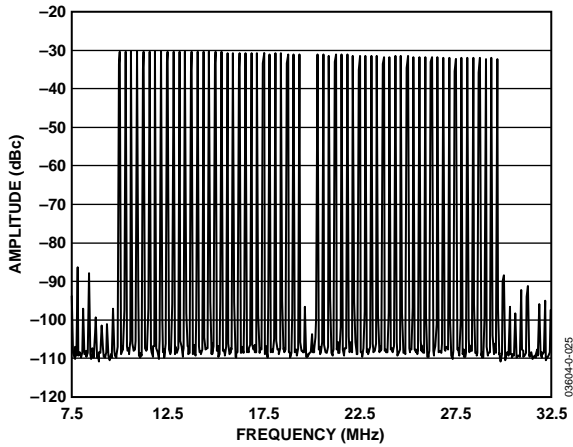

Figure 28. AD9863 Tx Path FFT, 64-Carrier (Two Center Carriers Removed) OFDM Signal over 20 MHz Bandwidth, Centered at 20 MHz, with 20 mA Full-Scale Output into 60 Ω Differential Load

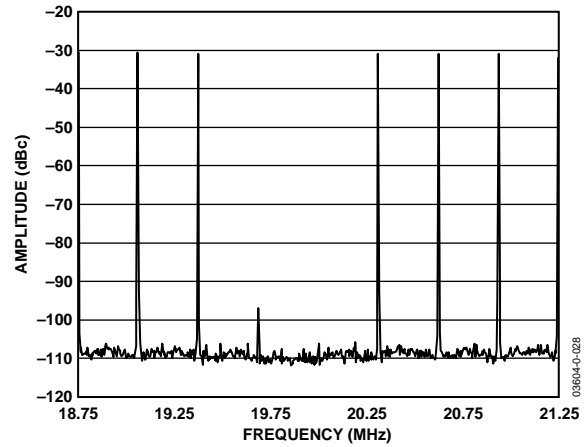

Figure 31. AD9863 Tx Path FFT, In-Band IMD Products of OFDM Signal in Figure 28

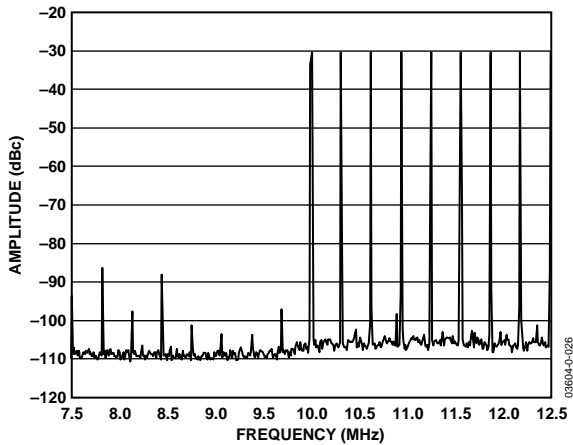

Figure 29. AD9863 Tx Path FFT, Lower-Band IMD Products of OFDM Signal in Figure 28

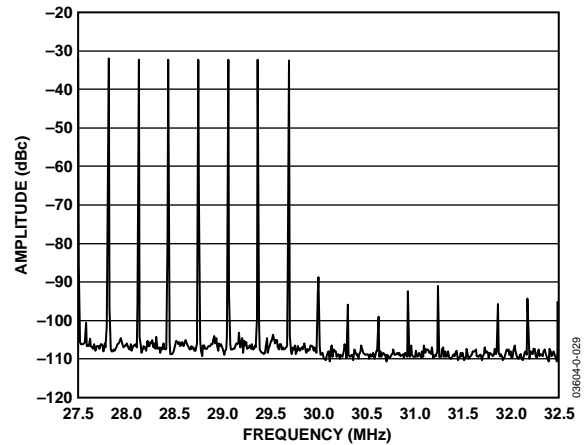

Figure 32. AD9863 Tx Path FFT, Lower-Band IMD Products of OFDM Signal in Figure 28

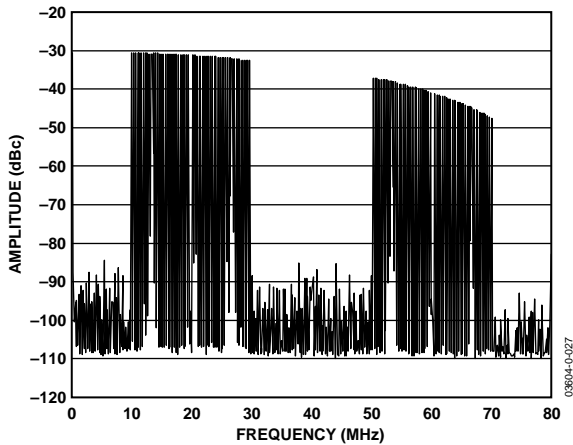

Figure 30. AD9863 Tx Path FFT of OFDM Signal in Figure 28 with 1x Interpolation

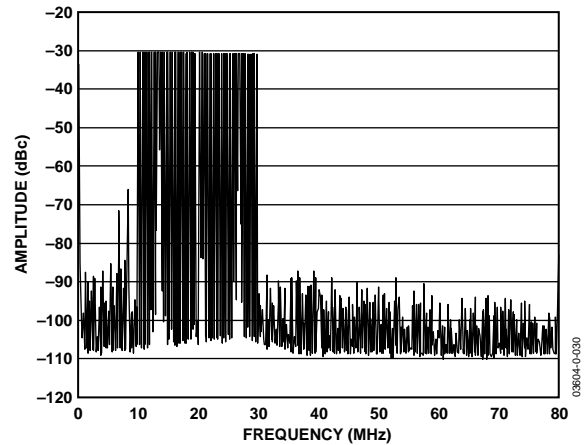

Figure 33. AD9863 Tx Path FFT of OFDM Signal in Figure 28 with 2x Interpolation

Figure 34 to Figure 39 use the same input data to the Tx path, a 256-carrier OFDM signal over a 1.75 MHz bandwidth, centered at 7 MHz. The four center carriers are removed from the signal to observe the in-band intermodulation distortion (IMD) from the DAC output.

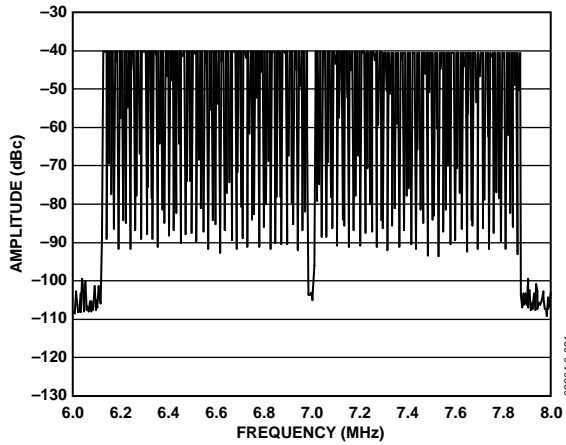

Figure 34. AD9863 Tx Path FFT, 256-Carrier (Four Center Carriers Removed) OFDM Signal over 1.75 MHz Bandwidth, Centered at 7 MHz, with 20 mA Full-Scale Output into 60 Ω Differential Load

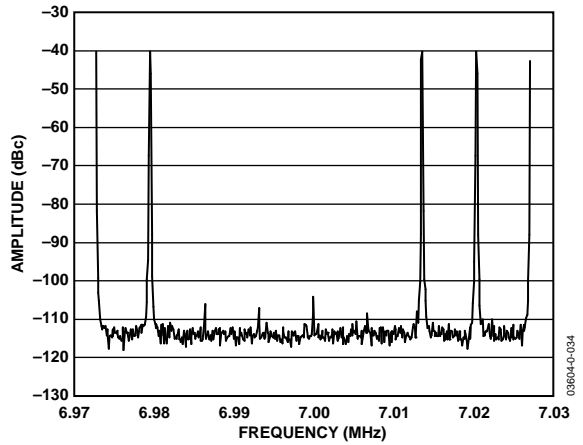

Figure 37. AD9863 Tx Path FFT, In-Band IMD Products of OFDM Signal in Figure 34

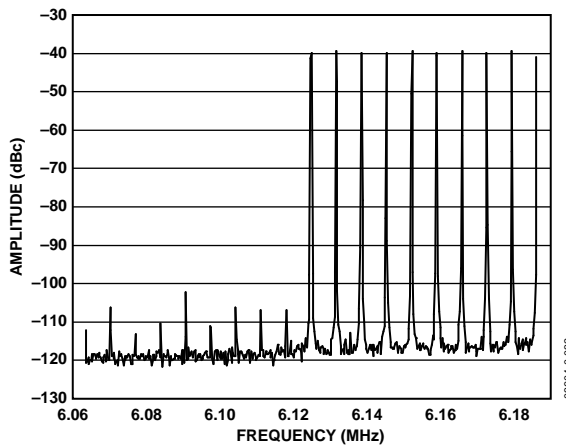

Figure 35. AD9863 Tx Path FFT, Lower-Band IMD Products of OFDM Signal in Figure 34

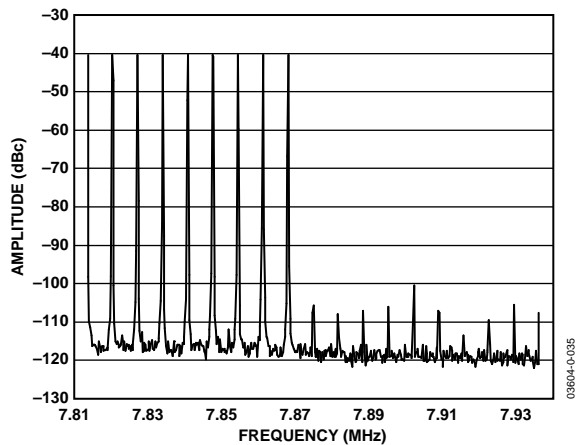

Figure 38. AD9863 Tx Path FFT, Upper-Band IMD Products of OFDM Signal in Figure 34

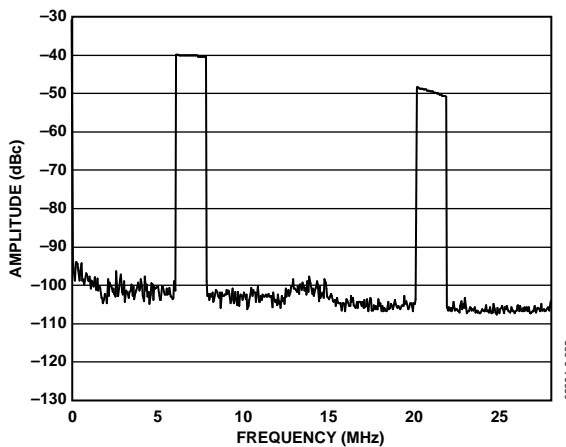

Figure 36. AD9863 Tx Path FFT of OFDM Signal in Figure 34, with 1× Interpolation

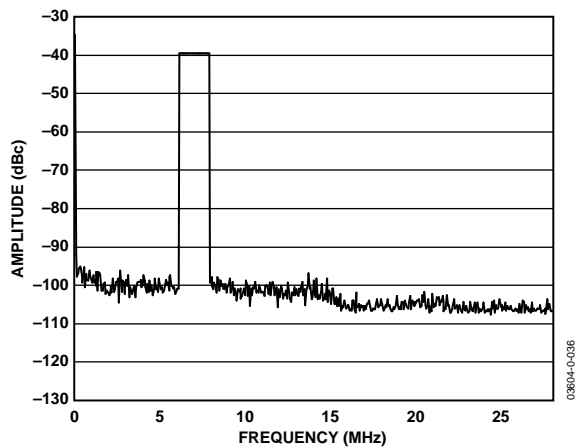

Figure 39. AD9863 Tx Path FFT of OFDM Signal in Figure 34, with 2× Interpolation

Figure 40 to Figure 45 use the same input data to the Tx path, a 256-carrier OFDM signal over a 23 MHz bandwidth, centered at 23 MHz. The four center carriers are removed from the signal to observe the in-band intermodulation distortion (IMD) from the DAC output.

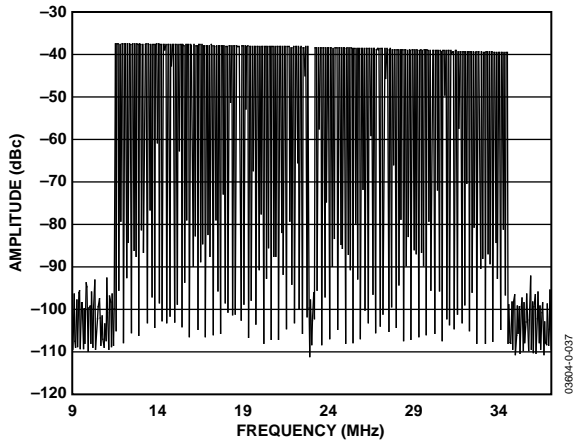

Figure 40. AD9863 Tx Path FFT, 256-Carrier (Four Center Carriers Removed) OFDM Signal over 23 MHz Bandwidth, Centered at 7 MHz, with 20 mA Full-Scale Output into 60 Ω Differential Load

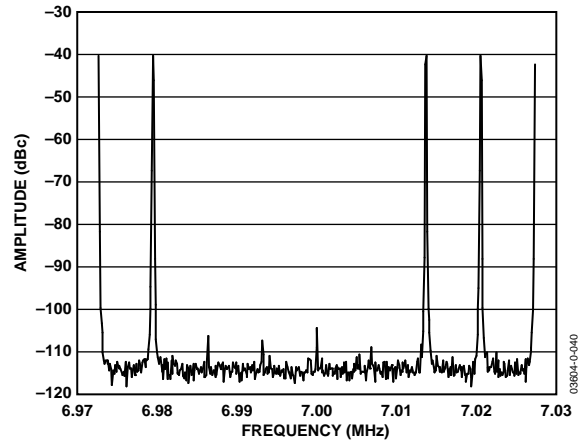

Figure 43. AD9863 Tx Path FFT, In-Band IMD Products of OFDM Signal in Figure 40

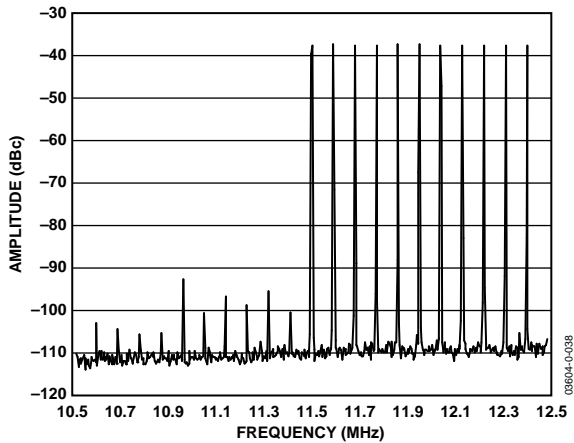

Figure 41. AD9863 Tx Path FFT, Lower-Band IMD Products of OFDM Signal in Figure 40

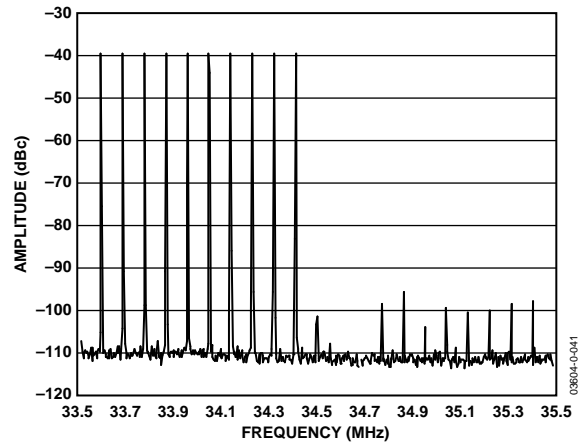

Figure 44. AD9863 Tx Path FFT, Upper-Band IMD Products of OFDM Signal in Figure 40

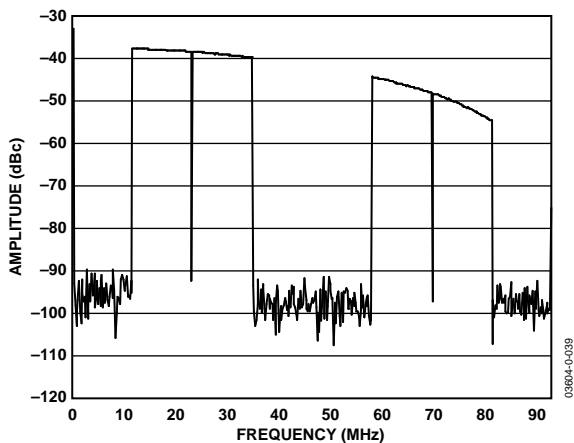

Figure 42. AD9863 Tx Path FFT of OFDM Signal in Figure 40, with 1× Interpolation

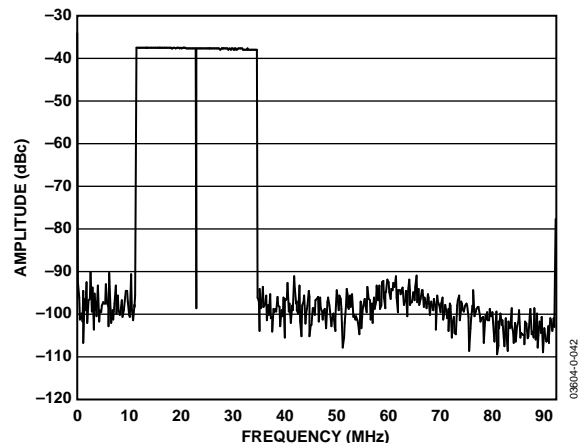

Figure 45. AD9863 Tx Path FFT of OFDM Signal in Figure 40, with 2× Interpolation

TERMINOLOGY

Input Bandwidth

The analog input frequency at which the spectral power of the fundamental frequency (as determined by the FFT analysis) is reduced by 3 dB.

Aperture Delay

The delay between the 50% point of the rising edge of the CLKIN1 signal and the instant at which the analog input is actually sampled.

Aperture Uncertainty (Jitter)

The sample-to-sample variation in aperture delay.

Crosstalk

Coupling onto one channel being driven by a -0.5 dBFS signal when the adjacent interfering channel is driven by a full-scale signal.

Differential Analog Input Voltage Range

The peak-to-peak differential voltage that must be applied to the converter to generate a full-scale response. Peak differential voltage is computed by observing the voltage on a single pin and subtracting the voltage from the other pin, which is 180° out of phase. Peak-to-peak differential is computed by rotating the input phase 180° and taking the peak measurement again. Then the difference is computed between both peak measurements.

Differential Nonlinearity

The deviation of any code width from an ideal 1 LSB step.

Effective Number of Bits (ENOB)

The effective number of bits is calculated from the measured SNR based on the following equation:

$$ENOB = \frac{SNR_{MEASURED} - 1.76 \text{ dB}}{6.02}$$

Pulse Width/Duty Cycle

Pulse width high is the minimum amount of time that a signal must be left in the logic high state to achieve rated performance; pulse width low is the minimum time a signal must be left in the low state, logic low.

Full-Scale Input Power

Expressed in dBm, full-scale input power is computed using the following equation:

$$Power_{FULLSCALE} = 10 \log \left(\frac{V_{FULLSCALE-RMS}^2 / Z_{INPUT}}{0.001} \right)$$

Gain Error

Gain error is the difference between the measured and ideal full-scale input voltage range of the ADC.

Harmonic Distortion, Second

The ratio of the rms signal amplitude to the rms value of the second harmonic component, reported in dBc.

Harmonic Distortion, Third

The ratio of the rms signal amplitude to the rms value of the third harmonic component, reported in dBc.

Integral Nonlinearity

The deviation of the transfer function from a reference line measured in fractions of an LSB using a “best straight line” determined by a least square curve fit.

Minimum Conversion Rate

The encode rate at which the SNR of the lowest analog signal frequency drops by no more than 3 dB below the guaranteed limit.

Maximum Conversion Rate

The encode rate at which parametric testing is performed.

Output Propagation Delay

The delay between a differential crossing of CLK+ and CLK– and the time when all output data bits are within valid logic levels.

Power Supply Rejection Ratio

The ratio of a change in input offset voltage to a change in power supply voltage.

Signal-to-Noise and Distortion (SINAD)

The ratio of the rms signal amplitude (set 1 dB below full scale) to the rms value of the sum of all other spectral components, including harmonics, but excluding dc.

Signal-to-Noise Ratio (without Harmonics)

The ratio of the rms signal amplitude (set at 1 dB below full scale) to the rms value of the sum of all other spectral components, excluding the first five harmonics and dc.

Spurious-Free Dynamic Range (SFDR)

The ratio of the rms signal amplitude to the rms value of the peak spurious spectral component. The peak spurious component may or may not be a harmonic. It also may be reported in dBc (for example, degrades as signal level is lowered) or dBFS (for example, always related back to converter full scale). SFDR does not include harmonic distortion components.

Worst Other Spur

The ratio of the rms signal amplitude to the rms value of the worst spurious component (excluding the second and third harmonics) reported in dBc.

THEORY OF OPERATION

SYSTEM BLOCK

The AD9863 is targeted to cover the mixed-signal front end needs of multiple wireless communications systems. It features a receive path that consists of dual 12-bit receive ADCs and a transmit path that consists of dual 12-bit transmit DACs (TxDAC). The AD9863 integrates additional functionality typically required in most systems, such as power scalability, Tx gain control, and clock multiplication circuitry.

The AD9863 minimizes both size and power consumption to address the needs of a range of applications from the low power portable market to the high performance base station market. The part is provided in a 64-lead lead frame chip scale package (LFCSP) that has a footprint of only 9 mm × 9 mm. Power consumption can be optimized to suit the particular application beyond just a speed grade option by incorporating power-down controls, low power ADC modes, TxDAC power scaling, and a half-duplex mode, which automatically disables the unused digital path.

The AD9863 uses two 12-bit buses to transfer Rx path data and Tx path data. These two buses support 24-bit parallel data transfers or 12-bit interleaved data transfers. The bus is configurable through either external mode pins or internal registers settings. The registers allow many more options for configuring the entire device.

The following sections discuss the various blocks of the AD9863: Rx Path Block, Tx Path Block, Digital Block, Programmable Registers, and Clock Distribution Block.

Rx PATH BLOCK

Rx Path General Description

The AD9863 Rx path consists of two 12-bit, 50 MSPS analog-to-digital converters (ADCs). The dual ADC paths share the same clocking and reference circuitry to provide optimal matching characteristics. Each of the ADCs consists of a 9-stage differential pipelined switched capacitor architecture with output error correction logic.

The pipelined architecture permits the first stage to operate on a new input sample, while the remaining stages operate on preceding samples. Sampling occurs on the falling edge of the input clock. Each stage of the pipeline, excluding the last, consists of a low resolution flash ADC and a residual multiplier to drive the next stage of the pipeline. The residual multiplier uses the flash ADC output to control a switched capacitor digital-to-analog converter (DAC) of the same resolution. The DAC output is subtracted from the stage's input signal, and the residual is amplified (multiplied) to drive the next pipeline stage. The residual multiplier stage is also called a multiplying DAC (MDAC). One bit of redundancy is used in each stage to facilitate digital correction of flash errors. The last stage simply consists of a flash ADC.

The differential input stage is dc self-biased and allows differential or single-ended inputs. The output-staging block aligns the data, carries out the error correction, and passes the data to the output buffers.

The latency of the Rx path is about 5 clock cycles.

Rx Path Analog Input Equivalent Circuit

The Rx path analog inputs of the AD9863 incorporate a novel structure that merges the function of the input sample-and-hold amplifiers (SHAs) and the first pipeline residue amplifiers into a single, compact switched capacitor circuit. By eliminating one amplifier in the pipeline, this structure achieves considerable noise and power savings over a conventional implementation that uses separate amplifiers.

Figure 46 illustrates the equivalent analog inputs of the AD9863 (a switched capacitor input). Bringing CLK to logic high opens Switch S3 and closes Switch S1 and Switch S2; this is the sample mode of the input circuit. The input source connected to VIN+ and VIN- must charge capacitor C_H during this time. Bringing CLK to a logic low opens Switch S2, and then Switch S1 opens, followed by the closing of Switch S3. This puts the input circuit into hold mode.

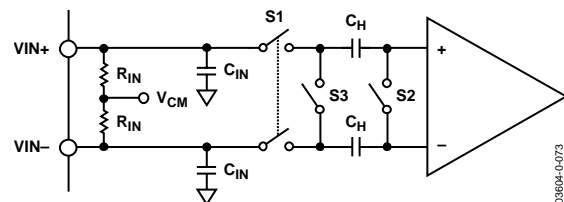

Figure 46. Differential Input Architecture

The structure of the input SHA places certain requirements on the input drive source. The differential input resistors are typically 2 kΩ each. The combination of the pin capacitance, C_{IN}, and the hold capacitance, C_H, is typically less than 5 pF. The input source must be able to charge or discharge this capacitance to 12-bit accuracy in one-half of a clock cycle. When the SHA goes into sample mode, the input source must charge or discharge capacitor C_H from the voltage already stored on it to the new voltage. In the worst case, a full-scale voltage step on the input source must provide the charging current through the R_{ON} of Switch S1 (typically 100 Ω) to a settled voltage within one-half of the ADC sample period. This situation corresponds to driving a low input impedance. On the other hand, when the source voltage equals the value previously stored on C_H, the hold capacitor requires no input current and the equivalent input impedance is extremely high.

Rx Path Application Section

Adding series resistance between the output of the signal source and the VIN pins reduces the drive requirements placed on the signal source. Figure 47 shows this configuration.

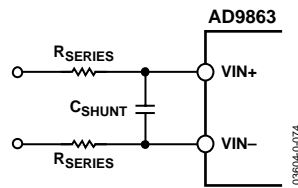

Figure 47. Typical Input

The bandwidth of the particular application limits the size of this resistor. For applications with signal bandwidths less than 10 MHz, the user may insert series input resistors and a shunt capacitor to produce a low-pass filter for the input signal. In addition, adding a shunt capacitance between the VIN pins can lower the ac load impedance. The value of this capacitance depends on the source resistance and the required signal bandwidth.

The Rx input pins are self-biased to provide this midsupply, common-mode bias voltage, so it is recommended to ac couple the signal to the inputs using dc blocking capacitors. In systems that must use dc coupling, use an op amp to comply with the input requirements of the AD9863. The inputs accept a signal with a 2 V p-p differential input swing centered about one-half of the supply voltage ($AVDD/2$). If the dc bias is supplied externally, the internal input bias circuit must be powered down by writing to registers Rx_A dc bias [Register 0x03, Bit 6] and Rx_B dc bias [Register 0x04, Bit 7].

The ADCs in the AD9863 are designed to sample differential input signals. The differential input provides improved noise immunity and better THD and SFDR performance for the Rx path. In systems that use single-ended signals, these inputs can be digitized, but it is recommended that a single-ended-to-differential conversion be performed. A single-ended-to-differential conversion can be performed by using a transformer coupling circuit (typically for signals above 10 MHz) or by using an operational amplifier, such as the AD8138 (typically for signals below 10 MHz).

ADC Voltage References

The AD9863 12-bit ADCs use internal references that are designed to provide for a 2 V p-p differential input range. The internal band gap reference generates a stable 1 V reference level and is decoupled through the VREF pin. REFT and REFB are the differential references generated based on the voltage level of VREF. Figure 48 shows the proper decoupling of the reference pins VREF, REFT, and REFB when using the internal reference. Decoupling capacitors must be placed as close to the reference pins as possible.

External references REFT and REFB are centered at $AVDD/2$ with a differential voltage equal to the voltage at VREF (by default 1 V when using the internal reference), allowing a peak-to-peak differential voltage swing of $2 \times VREF$.

For example, the default 1 V VREF reference accepts a 2 V p-p differential input swing, and the offset voltage must be

$$REFT = AVDD/2 + 0.5 V$$

$$REFB = AVDD/2 - 0.5 V$$

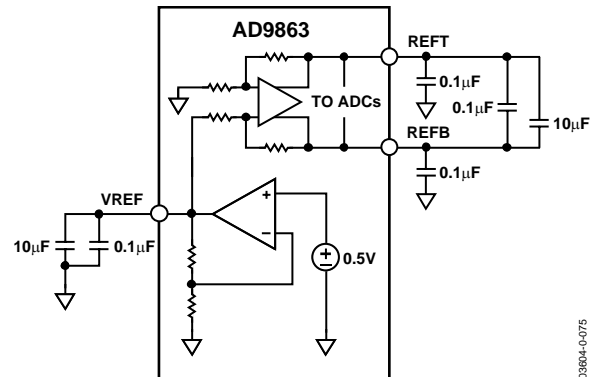

Figure 48. Typical Rx Path Decoupling

An external reference may be used for systems that require a different input voltage range, high accuracy gain matching between multiple devices, or improvements in temperature drift and noise characteristics. When an external reference is desired, the internal Rx band gap reference must be powered down using the VREF register [Register 0x05, Bit 4], with the external reference driving the voltage level on the VREF pin. The external voltage level must be one-half of the desired peak-to-peak differential voltage swing. The result is that the differential voltage references are driven to new voltages:

$$REFT = AVDD/2 + V_{REF}/2 V$$

$$REFB = AVDD/2 - V_{REF}/2 V$$

If an external reference is used, it is recommended not to exceed a differential offset voltage greater than 1 V for the reference.

Clock Input and Considerations

Typical high speed ADCs use both clock edges to generate a variety of internal timing signals and, as a result, may be sensitive to clock duty cycle. Commonly, a 5% tolerance is required on the clock duty cycle to maintain dynamic performance characteristics. The AD9863 contains clock duty cycle stabilizer circuitry (DCS). The DCS retimes the internal ADC clock (nonsampling edge) and provides the ADC with a nominal 50% duty cycle. Input clock rates of over 40 MHz can use the DCS so that a wide range of input clock duty cycles can be accommodated. Conversely, DCS must not be used for Rx sampling below 40 MSPS. Maintaining a 50% duty cycle clock is particularly important in high speed applications when proper sample-and-hold times for the converter are required to maintain high performance. The DCS can be enabled by writing highs to the Rx_A/Rx_B CLK duty register bits [Register 0x06/ Register 0x07, Bit 4].

The duty cycle stabilizer uses a delay-locked loop to create the nonsampling edge. As a result, any changes to the sampling frequency require approximately 2 μ s to 3 μ s to allow the DLL to adjust to the new rate and settle. High speed, high resolution ADCs are sensitive to the quality of the clock input.

The degradation in SNR at a given full-scale input frequency (f_{INPUT}), due to aperture jitter (t_A), can be calculated with the following equation:

$$\text{SNR degradation} = 20 \log \left[\left(\frac{1}{2} \right) \pi f_{\text{INTA}} t_A \right]$$

In the equation, the rms aperture jitter, t_A , represents the root-sum-square of all jitter sources, which includes the clock input, analog input signal, and ADC aperture jitter specification. Undersampling applications are particularly sensitive to jitter. The clock input is a digital signal that must be treated as an analog signal with logic level threshold voltages, especially in cases where aperture jitter may affect the dynamic range of the AD9863. Power supplies for clock drivers must be separated from the ADC output driver supplies to avoid modulating the clock signal with digital noise. Low jitter crystal-controlled oscillators make the best clock sources. If the clock is generated from another type of source (by gating, dividing, or other methods), it must be retimed by the original clock at the last step.

Power Dissipation and Standby Mode

The power dissipation of the AD9863 Rx path is proportional to its sampling rate. The Rx path portion of the digital (DRVDD) power dissipation is determined primarily by the strength of the digital drivers and the load on each output bit. The digital drive current can be calculated by

$$I_{\text{DRVDD}} = V_{\text{DRVDD}} \times C_{\text{LOAD}} \times f_{\text{CLOCK}} \times N$$

where N is the number of bits changing and C_{LOAD} is the average load on the digital pins that changed.

The analog circuitry is optimally biased so that each speed grade provides excellent performance while affording reduced power consumption. Each speed grade dissipates a baseline power at low sample rates, which increases with clock frequency. The baseline power dissipation for either speed grade can be reduced by asserting the ADC_LO_PWR pin, which reduces internal ADC bias currents by half, in some cases resulting in degraded performance.

To further reduce power consumption of the ADC, the ADC_LO_PWR pin can be combined with a serial programmable register setting to configure an ultralow power mode. The ultralow power mode reduces power consumption by a fourth of the normal power consumption. The ultralow power mode can be used at slower sampling frequencies or if reduced performance is acceptable. To configure the ultralow power mode, assert the ADC_LO_PWR pin during power-up and write the following register settings:

Register 0x08 (MSB) 0000 1100
 Register 0x09 (MSB) 0111 0000
 Register 0x0A (MSB) 0111 0000

Figure 49 shows the typical analog power dissipation ($\text{ADC_AVDD} = 3.3 \text{ V}$) for the ADC vs. sampling rate for the normal power, low power, and ultralow power modes.

Either of the ADCs in the AD9863 Rx path can be placed in standby mode independently by writing to the appropriate SPI register bits in Register 3, Register 4, and Register 5. The minimum standby power is achieved when both channels are placed in full power-down mode using the appropriate SPI register bits in Register 3, Register 4, and Register 5. Under this condition, the internal references are powered down. When either or both of the channel paths are enabled after a power-down, the wake-up time is directly related to the recharging of the REFT and REFB decoupling capacitors and the duration of the power-down. Typically, it takes approximately 5 ms to restore full operation with fully discharged 0.1 μF and 10 μF decoupling capacitors on REFT and REFB.

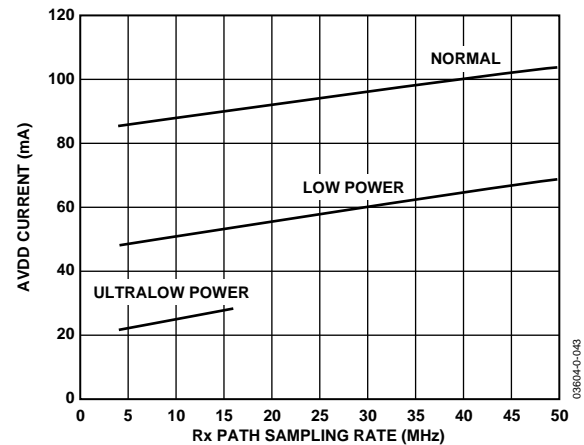

Figure 49. Typical Rx Path Analog Supply Current vs. Sample Rate, $V_{\text{DD}} = 3.3 \text{ V}$ for Normal, Low, and Ultralow Power Modes

Tx PATH BLOCK

The AD9863 transmit (Tx) path includes dual interpolating 12-bit current output DACs that can be operated independently or can be coupled to form a complex spectrum in an image reject transmit architecture. Each channel includes two FIR filters, making the AD9863 capable of 1 \times , 2 \times , or 4 \times interpolation. High speed input and output data rates can be achieved within the limitations listed in Table 9.

Table 9. AD9863 Tx Path Maximum Data Rate

Interpolation Rate	24-Bit Interface Mode	Input Data Rate per Channel (MSPS)	DAC Sampling Rate (MSPS)
1 \times	FD, HD12, Clone	80	80
	HD24	160	160
2 \times	FD, HD12, Clone	80	160
	HD24	80	160
4 \times	FD, HD12, Clone	50	200
	HD24	50	200

By using the dual DAC outputs to form a complex signal, an external analog quadrature modulator, such as the Analog Devices AD8349, can enable an image rejection architecture. (Note: the AD9863 evaluation board includes a quadrature modulator in the Tx path that accommodates the AD8345, AD8346, and AD8349 footprints.)

To optimize the image rejection capability as well as LO feedthrough suppression in this architecture, the AD9863 offers programmable (via the SPI port), fine (trim) gain and offset adjustment for each DAC.

Also included in the AD9863 are a phase-locked loop (PLL) clock multiplier and a 1.2 V band gap voltage reference. With the PLL enabled, a clock applied to the CLKIN2 input is multiplied internally and generates all necessary internal synchronization clocks. Each 12-bit DAC provides two complementary current outputs whose full-scale currents can be determined from a single external resistor.

An external pin, TxPWRDWN, can be used to power down the Tx path when not in use, optimizing system power consumption. Using the TxPWRDWN pin disables clocks and some analog circuitry, saving both digital and analog power. The power-down mode leaves the biases enabled to facilitate a quick recovery time, typically <math><10 \mu\text{s}</math>. In addition, a sleep mode is available that turns off the DAC output current but leaves all other circuits active for a modest power savings. An SPI-compliant serial port is used to program the many features of the AD9863. Note that in power-down mode, the SPI port is still active.

DAC Equivalent Circuits

The AD9863 Tx path, consisting of dual 12-bit DACs, is shown in Figure 50. The DACs integrate a high performance TxDAC core, a programmable gain control through a programmable gain amplifier (TxPGA), coarse gain control, and offset adjustment and fine gain control to compensate for system mismatches. Coarse gain applies a gross scaling to either DAC by $1\times$, $(1/2)\times$, or $(1/11)\times$. The TxPGA provides gain control from 0 dB to -20 dB in steps of 0.1 dB and is controlled via the 8-bit TxPGA setting. A fine gain adjustment of $\pm 4\%$ for each channel is controlled through a 6-bit fine gain register. By default, coarse gain is $1\times$, the TxPGA is set to 0 dB, and the fine gain is set to 0%.

The TxDAC core of the AD9863 provides dual, differential, complementary current outputs generated from the 12-bit data. The 12-bit dual DACs support update rates up to 200 MSPS. The differential outputs (IOUT+ and IOUT-) of each dual DAC are complementary, meaning that they always add up to the full-scale current output of the DAC, I_{OUTFS} . Optimum ac performance is achieved when the differential current interface drives balanced loads or a transformer.

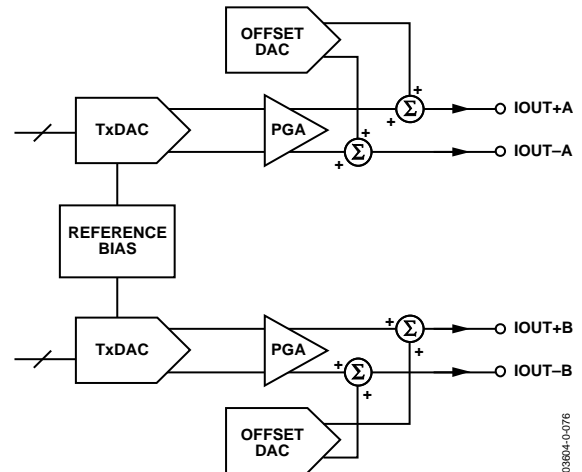

Figure 50. TxDAC Output Structure Block Diagram

The fine gain control provides improved balance of QAM modulated signals, resulting in improved modulation accuracy and image rejection.

The independent DAC A and DAC B offset control adds a small dc current to either IOUT+ or IOUT- (not both). The selection of which IOUT this offset current is directed toward is programmable via register setting. Offset control can be used for suppression of a LO leakage signal that typically results at the output of the modulator.

If the AD9863 is dc-coupled to an external modulator, this feature can be used to cancel the output offset on the AD9863 as well as the input offset on the modulator. The reference circuitry is shown in Figure 51.

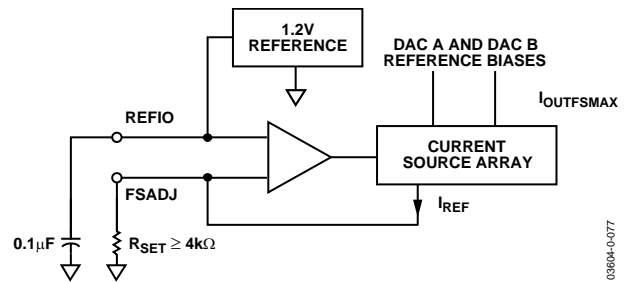

Figure 51. Reference Circuitry

Referring to the transfer function of the following equation, $I_{OUTFSMAX}$ is the maximum current output of the DAC with the default gain setting (0 dB) and is based on a reference current, I_{REF} . I_{REF} is set by the internal 1.2 V reference and the external R_{SET} resistor.

$$I_{OUTFSMAX} = 64 \times (REFIO/R_{SET})$$

Typically, R_{SET} is 4 k Ω , which sets $I_{OUTFSMAX}$ to 20 mA, the optimal dynamic setting for the TxDACs. Increasing R_{SET} by a factor of 2 proportionally decreases $I_{OUTFSMAX}$ by a factor of 2. $I_{OUTFSMAX}$ of each DAC can be rescaled either simultaneously, using the TxPGA gain register, or independently, using the DAC A/DAC B coarse gain registers.

The TxPGA function provides 20 dB of simultaneous gain range for both DACs, and it is controlled by writing to the SPI register TxPGA gain for a programmable full-scale output of 10% to 100% of $I_{OUTFSMAX}$. The gain curve is linear in dB, with steps of about 0.1 dB. Internally, the gain is controlled by changing the main DAC bias currents with an internal TxPGA DAC whose output is heavily filtered via an on-chip R-C filter to provide continuous gain transitions. Note that the settling time and bandwidth of the TxPGA DAC can be improved by a factor of 2 by writing to the TxPGA fast update register.

Each DAC has independent coarse gain control. Coarse gain control can be used to accommodate different I_{OUTFS} from the dual DACs. The coarse full-scale output control can be adjusted by using the DAC A/DAC B coarse gain registers to 1/2 or 1/11 of the nominal full-scale current.

Fine gain controls and dc offset controls can be used to compensate for mismatches (for system level calibration), allowing improved matching characteristics of the two Tx channels and aiding in suppressing LO feedthrough. This is especially useful in image rejection architectures. The 10-bit dc offset control of each DAC can be used independently to provide an offset of up to $\pm 12\%$ of $I_{OUTFSMAX}$ to either differential pin, thus allowing calibration of any system offset. The fine gain control with 5-bit resolution allows the $I_{OUTFSMAX}$ of each DAC to be varied over a $\pm 4\%$ range, allowing compensation of any DAC or system gain mismatches. Fine gain control is set through the DAC A/DAC B fine gain registers, and the offset control of each DAC is accomplished using the DAC A/DAC B offset registers.

Clock Input Configuration

The quality of the clock and data input signals is important in achieving optimum performance. The external clock driver circuitry provides the AD9863 with a low jitter clock input that meets the min/max logic levels while providing fast edges. When a driver is used to buffer the clock input, it must be placed very close to the AD9863 clock input, thereby negating any transmission line effects such as reflections due to mismatch.

Programmable PLL

CLKIN2 can function either as an input data rate clock (PLL enabled) or as a DAC data rate clock (PLL disabled).

The PLL clock multiplier and distribution circuitry produce the necessary internal timing to synchronize the rising edge triggered latches for the enabled interpolation filters and DACs. This circuitry consists of a phase detector, charge pump, voltage controlled oscillator (VCO), and clock distribution block, all under SPI port control. The charge pump, phase detector, and VCO are powered from PLL_AVDD, while the clock distribution circuits are powered from the DVDD supply.

To ensure optimum phase noise performance from the PLL clock multiplier circuits, PLL_AVDD must originate from a clean analog supply. The speed of the VCO within the PLL also has an effect on phase noise.

The PLL locks with VCO speeds as low as 32 MHz up to 350 MHz, but optimal phase noise with respect to VCO speed is achieved by running it in the range of 64 MHz to 200 MHz.

Power Dissipation

The AD9863 Tx path power is derived from three voltage supplies: AVDD, DVDD, and DRVDD.

IDRVDD and IDVDD are very dependent on the input data rate, the interpolation rate, and the activation of the internal digital modulator. IAVDD has the same type of sensitivity to data, interpolation rate, and the modulator function, but to a much lesser degree (<10%).

Sleep/Power-Down Modes

The AD9863 provides multiple methods for programming power saving modes. The externally controlled TxPWRDWN or SPI programmed sleep mode and the full power-down mode are the main options.

TxPWRDWN is used to disable all clocks and much of the analog circuitry in the Tx path when asserted. In this mode, the biases remain active, therefore reducing the time required for re-enabling the Tx path. The time of recovery from power-down for this mode is typically less than 10 μ s.

Sleep mode, when activated, turns off the DAC output currents, but the rest of the chip remains functioning. When coming out of sleep mode, the AD9863 immediately returns to full operation.

A full power-down mode can be enabled through the SPI register, which turns off all Tx path related analog and digital circuitry in the AD9863. When returning from full power-down mode, enough clock cycles must be allowed to flush the digital filters of random data acquired during the power-down cycle.

Interpolation Stage

Interpolation filters are available for use in the AD9863 transmit path, providing 1 \times (bypassed), 2 \times , or 4 \times interpolation.

The interpolation filters effectively increase the Tx data rate while suppressing the original images. The interpolation filters digitally shift the worst-case image further away from the desired signal, thus reducing the requirements on the analog output reconstruction filter.

There are two 2 \times interpolation filters available in the Tx path. An interpolation rate of 4 \times is achieved using both interpolation filters; an interpolation rate of 2 \times is achieved by enabling only the first 2 \times interpolation filter.

The first interpolation filter provides 2 \times interpolation using a 39-tap filter. It suppresses out-of-band signals by 60 dB or more and has a flat pass-band response (less than 0.1 dB ripple) extending to 38% of the input Tx data rate (19% of the DAC update rate, f_{DAC}). The maximum input data rate is 80 MSPS per channel when using 2 \times interpolation.

The second interpolation filter provides an additional 2 \times interpolation for an overall 4 \times interpolation. The second filter is a 15-tap filter, which suppresses out-of-band signals by 60 dB or more.

The flat pass-band response (less than 0.1 dB attenuation) is 38% of the Tx input data rate (9.5% of f_{DAC}). The maximum input data rate per channel is 50 MSPS per channel when using 4× interpolation.

Latch/Demultiplexer

Data for the dual-channel Tx path can be latched in parallel through two ports in half-duplex operations (HD24 mode) or through a single port by interleaving the data (FD, HD12, and clone modes). See the Flexible I/O Interface Options section in the Digital Block description that follows and the Clock Distribution Block section for further descriptions of each mode.

DIGITAL BLOCK

The AD9863 digital block allows the device to be configured in various timing and operation modes. The following sections discuss the flexible I/O interfaces, the clock distribution block, and the programming of the device through mode pins or SPI registers.

Flexible I/O Interface Options

The AD9863 can accommodate various data interface transfer options (flexible I/O). The AD9863 uses two 12-bit buses, an upper bus (U12) and a lower bus (L12), to transfer the dual-channel 12-bit ADC data and dual-channel 12-bit DAC data by means of interleaved data, parallel data, or a mix of both. Table 10 shows the different I/O configurations of the modes depending on half-duplex or full-duplex operation. Table 11 and Table 12 summarize the pin configurations vs. the modes.

Table 10. Flexible Data Interface Modes

Mode Name	Tx Only Mode (Half-Duplex)	Rx Only Mode (Half-Duplex)	Concurrent Tx + Rx Mode (Full-Duplex)	General Notes
HD24			N/A	Rx data rate = 1 × ADC sample rate Two 12-bit parallel Rx data buses Tx data rate = 1 × ADC sample rate Two 12-bit parallel Tx data buses
HD12			N/A	Rx data rate = 2 × ADC sample rate One 12-bit interleaved Rx data bus Tx data rate = 2 × ADC sample rate One 12-bit interleaved Tx data bus
FD				Rx data rate = 2 × ADC sample rate One 12-bit interleaved Rx data bus Tx data rate = 2 × ADC sample rate One 12-bit interleaved Tx data bus
Clone			N/A	Rx data rate = 1 × ADC sample rate Two 12-bit parallel Rx data buses Tx data rate = 2 × ADC sample rate One 12-bit interleaved Tx data bus Requires SPI interface to configure; similar to AD9862 data interface

Table 11 describes AD9863 pin function (when mode pins are used) relative to I/O mode and for half-duplex modes, whether transmitting or receiving.

Table 11. AD9863 Pin Function vs. Interface Mode (No SPI Cases)¹

Mode Name	U12 Bus	L12 Bus	IFACE1	IFACE2	IFACE3
FD	Interleaved Tx data	Interleaved Rx data	TxSYNC	Buffered Rx Clock	Buffered Tx clock
HD12 (Tx/Rx = High)	Interleaved Tx data	MSB = TxSYNC Others = three-state	Tx/Rx = tied high	12/24 pin control tied high	Buffered Tx clock
HD12 (Tx/Rx = Low)	MSB = RxSYNC Others = three-state	Interleaved Rx data	Tx/Rx = tied low	12/24 pin control tied high	Buffered Rx clock
HD24 (Tx/Rx = High)	Tx_A data	Tx_B data	Tx/Rx = tied high	12/24 pin control tied low	Buffered Tx clock
HD24 (Tx/Rx = Low)	Rx_B data	Rx_A data	Tx/Rx = tied low	12/24 pin control tied low	Buffered Rx clock
Clone Mode (Tx/Rx = High)	x	x	x	x	x
Clone Mode (Tx/Rx = Low)	x	x	x	x	x

¹ Clone mode not available without SPI.

Table 12 describes AD9863 pin function (when SPI programming is used) relative to flexible I/O mode and for half-duplex modes, whether transmitting or receiving.

Table 12. AD9863 Pin Function vs. Interface Mode (Configured through the SPI Registers)

Mode Name	U12 Bus	L12 Bus	IFACE1	IFACE2	IFACE3
FD	Interleaved Tx data	Interleaved Rx data	TxSYNC	Buffered system clock	Buffered Tx clock
HD12, Tx Mode (Tx/Rx = High)	Interleaved Tx data	MSB = TxSYNC others = three-state	Tx/Rx = tied high	Optional buffered system clock	Buffered Tx clock
HD12, Rx Mode (Tx/Rx = Low)	MSB = RxSYNC Other = three-state	Interleaved Tx data	Tx/Rx = tied low	Optional buffered system clock	Buffered Rx clock
HD24, Tx Mode (Tx/Rx = High)	Tx_A data	Tx_B data	Tx/Rx = tied high	Optional buffered system clock	Buffered Tx clock
HD24, Rx Mode (Tx/Rx = Low)	Rx_B data	Rx_A data	Tx/Rx = tied low	Optional buffered system clock	Buffered Rx clock
Clone Mode, Tx Mode (Tx/Rx = High)	Interleaved Tx data	MSB = TxSYNC Others = three-state	Tx/Rx = tied high	Optional buffered system clock	Buffered Tx clock
Clone Mode, Rx Mode (Tx/Rx = Low)	Rx_B data	Rx_A data	Tx/Rx = tied low	Optional buffered system clock	Buffered Rx clock

Summary of Flexible I/O Modes

FD Mode

The full-duplex (FD) mode can be configured by using mode pins or with SPI programming. Using the SPI allows additional configuration flexibility of the device.

FD mode is the only mode that supports full-duplex, receive, and transmit concurrent operations. The upper 12-bit bus (U12) is used to accept interleaved Tx data, and the lower 12-bit bus (L12) is used to output interleaved Rx data. Either the Rx path or the Tx path (or both) can be independently powered down using either (or both) the RxPwrDwn and TxPwrDwn pins. FD mode requires interpolation of 2× or 4×.

The following notes provide a general description of the FD mode configuration. For more information, refer to Table 15.

Note the following about the Tx path in FD mode:

- Interpolation rate of 2× or 4× can be programmed with mode pins or SPI.
- Max DAC update rate = 200 MSPS.
Max Tx input data rate = 80 MSPS/channel (160 MSPS interleaved).
- TxSYNC is used to direct Tx input data.
TxSYNC = high indicates channel Tx_A data.
TxSYNC = low indicates channel Tx_B data.
- Buffered Tx clock output (from IFACE3 pin) equals 2× the DAC update rate; one rising edge per interleaved Tx sample.

Note the following about the Rx path in FD mode:

- ADC CLK Div register can be used to divide down the clock driving the ADC, which accepts up to 50 MHz.
- Max ADC sampling rate = 50 MSPS.
- The Rx path output data rate is 2× the ADC sample rate (interleaved).
- Rx_A output when IFACE2 logic level = low.
Rx_B output when IFACE2 logic level = high.

HD12 Mode

The half-duplex, 12-bit interleaved output mode, HD12, can be configured using mode pins or the SPI.

HD12 mode supports half-duplex only operations and can interface to a single 12-bit data bus with independent Rx and Tx synchronization pins (RxSYNC and TxSYNC). Both the U12 and L12 buses are used on the AD9863, but the logic level of the Tx/Rx selector (controlled through IFACE1 pin) is used to disable and three-state the unused bus, allowing U12 and L12 to be tied together. The MSB of the unused bus acts as the RxSYNC (during Rx operation) or TxSYNC (during Tx operation). A single pin is used to output the clocks for Rx and Tx data latching (from the IFACE3 pin) switching, depending on which path is enabled. HD12 mode requires interpolation of 2× or 4×.

The following notes provide a general description of the HD12 mode configuration. For more information, refer to Table 15.

Note the following about the Tx path in HD12 mode:

- Interpolation rate of 2× or 4× can be programmed with mode pins or SPI.
- Interleaved Tx data accepted on U12 bus, L12 bus MSB acts as TxSYNC.
- Max DAC update rate = 200 MSPS.
Max Tx input data rate = 80 MSPS/channel (160 MSPS interleaved).
- TxSYNC is used to direct Tx input data.
TxSYNC = high indicates channel Tx_A data.
TxSYNC = low indicates channel Tx_B data.

Note the following about the Rx path in HD12 mode:

- ADC CLK Div register can be used to divide down the clock driving the ADC, which accepts up to 50 MHz.
- Max ADC sampling rate = 50 MSPS.
- Output data rate = 2× ADC sample rate.
- Interleaved Rx data output from L12 bus.
- Rx_A output when IFACE2 (or RxSYNC) logic level = low.
Rx_B output when IFACE2 (or RxSYNC) logic level = high.

HD24 Mode

The half-duplex, 24-bit parallel output mode, HD24, can be configured using mode pins or through SPI programming.

HD24 mode supports half-duplex only operations and can interface to a single 24-bit data bus (two parallel 12-bit buses). Both the U12 and L12 buses are used on the AD9863. The logic level of the Tx/Rx selector (controlled through IFACE1 pin) is used to configure the buses as Rx outputs (during Rx operation) or as Tx inputs (during Tx operation). A single pin is used to output the clocks for Rx and Tx data latching (from the IFACE3 pin) switching, depending on which path is enabled.

The following notes provide a general description of the HD24 mode configuration. For more information, refer to Table 15.

Note the following about the Tx path in HD24 mode:

- Interpolation rate of 1×, 2×, or 4× can be programmed with mode pins or SPI.
- Max DAC update rate = 200 MSPS.
Max Tx input data rate = 160 MSPS/channel with bypassed interpolation filters, 100 MSPS for 2× interpolation, or 50 MSPS for 4× interpolation.
- Tx_A DAC data is accepted from the U12 bus; Tx_B DAC data is accepted from the L12 bus.

Note the following about the Rx path in HD24 mode:

- ADC CLK Div register can be used to divide down the clock driving the ADC, which accepts up to 50 MHz.
- Max ADC sampling rate = 50 MSPS.
- The Rx_A output data is output on L12 bus; the Rx_B output data is output on U12 bus.

Clone Mode

Clone mode is an interface mode that provides a similar interface to the AD9860 when used in half-duplex mode. This mode requires SPI to configure.

Clone mode provides a parallel Rx data output (24 bits) while in Rx mode, and it accepts interleaved Tx data (12-bit) while in Tx mode. Both the U12 and L12 buses are used on the AD9863. The logic level of the Tx/Rx selector (controlled through the IFACE1 pin) is used to configure the buses for Rx outputs (during Rx operation) or as Tx inputs (during Tx operation). A single pin is used to output the clocks for Rx and Tx data latching (from the IFACE3 pin), depending on which path is enabled. Clone mode requires interpolation of 2× or 4×.

The following notes provide a general description of the clone mode configuration. For more information, refer to Table 15.

Note the following about the Tx path in clone mode:

- Interpolation rate of 2× or 4× can be programmed with mode pins or SPI.
- Max DAC update rate = 200 MSPS.
Max Tx input data rate = 80 MSPS/channel (160 MSPS interleaved).

- TxSYNC is used to direct Tx input data.
TxSYNC = high indicates channel Tx_A data.
TxSYNC = low indicates channel Tx_B data.
- Buffered Tx clock output (from IFACE3 pin) uses one rising edge per interleaved Tx sample.

Note the following about the Rx path in clone mode:

- ADC CLK Div register can be used to divide down the clock driving the ADC, which accepts up to 50 MHz.
- Max ADC sampling rate = 50 MSPS.
- Output data rate = ADC sample rate, that is, two 12-bit parallel outputs per one buffer Rx clock output cycle.
- The Rx_A output data is output on L12 bus; the Rx_B output data is output on U12 bus.

Configuring with Mode Pins

The flexible interface can be configured with or without the SPI, although more options and flexibility are available when using the SPI to program the AD9863. Mode pins can be used to power down sections of the device, reduce overall power consumption, configure the flexible I/O interface, and program the interpolation setting. The SPI register map, which provides many more options, is presented in the Configuring with SPI section.

Mode Pins/Power-Up Configuration Options

Mode pins provide various options that are configurable at power-up. Control pins also provide options for power-down modes. The logic value of the configuration mode pins are latched when the device is brought out of reset (upon the rising edge of RESET). The mode pin names and functions are listed in Table 13. Table 14 provides a detailed description of the mode pins.

Table 13. Mode Pin Names and Functions

Pin Name	Duration	Function
RxPWRDWN	Permanent	When high, digital clocks to the Rx block are disabled. Analog circuitry that requires <10 μ s to power up is powered off.
TxPWRDWN	Permanent	When high, digital clocks to Tx block are disabled (PLL remains powered). Analog circuitry that requires <10 μ s to power up is powered off.
Tx/Rx (IFACE1)	Permanent only for HD Flex I/O interface	When high, digital clocks to the Tx block are disabled (PLL remains powered to maintain output clock with an optional SPI shutoff). Tx analog circuitry remains powered up unless Tx_PwrDwn is asserted. When low, digital clocks to Rx block are disabled. Rx analog circuitry remains powered up unless Rx_PwrDwn is asserted.
ADC_LO_PWR	Defined at reset or power-up	When enabled, this bit scales the ADC power-down by 40%.
SPI_Bus_Enable (SPI_CS)	Defined at reset or power-up	This function is controlled through the SPI_CS pin. This pin must remain low to maintain mode pin functionality (the SPI port remains nonfunctional). This pin must be high when coming out of reset to enable the SPI.
FD/HD	Defined at reset or power-up	Configures the flex I/O for FD or HD mode. This control applies only if the SPI bus is disabled.
12/24 Only valid for HD mode	Defined at reset or power-up	If the flex I/O bus is in HD mode, this bit is used to configure parallel or interleaved data mode. This control applies only if the SPI bus is disabled.
Interp0 and Interp1	Defined at reset or power-up	The Interp1 and Interp0 bits configure the PLL and the interpolation rate to 1 \times [00], 2 \times [01], or 4 \times [10]. This control applies only if the SPI bus is disabled.

Table 14. Mode Pin Names and Descriptions

Pin Name	Description
ADC_LO_PWR	ADC Low Power Mode Option. ADC_LO_PWR is latched during the rising edge of $\overline{\text{RESET}}$. Logic low results in ADC operation at nominal power mode. Logic high results in the ADC consuming 40% less power than the nominal power mode.
$\overline{\text{FD/HD}}$ (SDO)	For flex I/O configuration, this control applies only if the SPI bus is disabled. $\overline{\text{FD/HD}}$ (SDO) is latched during the rising edge of $\overline{\text{RESET}}$. Logic low setting identifies that the DUT flex I/O port will be configured for half-duplex operation. 12/24 (IFACE2) is also latched during the rising edge of $\overline{\text{RESET}}$ to identify interleaved data mode or parallel data mode. Logic low indicates that the flex I/O will configure itself for parallel data mode. Logic high indicates that the flex I/O will configure itself for interleaved data mode.
12/24	For flex I/O configuration, the 12/24 pin control applies only if the SPI bus is disabled and the device is configured for HD mode. 12/24 is latched during the rising edge of $\overline{\text{RESET}}$. 12/24 (IFACE2) is used to identify interleaved data mode or parallel data modes. Logic low indicates that the flex I/O will configure itself for HD24 mode. Logic high indicates that the flex I/O will configure itself for HD12 mode.
SPI_Bus_Enable (SPI_CS)	SPI_CS is latched during the rising edge of $\overline{\text{RESET}}$. Logic low results in the SPI being disabled; SPI_DIO, SPI_CLK, and SPI_SDO act as mode pins configuration pins. Logic high results in the SPI being fully operational; some mode pins will be disabled.
Interp0 and Interp1	Interpolation/PLL Factor Configuration. This control applies only if the SPI bus is disabled. SPI_DIO (Interp1) and SPI_CLK (Interp0) configure the Tx path for 1× [00], 2× [01], or 4× [10] interpolation and also enable the PLL of the same multiplication factor.
RxPWRDWN	Power-Down Control. RxPWRDWN logic level controls the power-down function of the Rx path. Logic low results in the Rx path operating at normal power levels. Logic high disables the ADC clock and disables some bias circuitry to reduce power consumption.
TxPWRDWN	Power-Down Control. TxPWRDWN logic level controls the power-down function of the Tx path. Logic low results in the Tx path operating at normal power levels. Logic high disables the DAC clocks and disables some bias circuitry to reduce power consumption.
$\overline{\text{Tx/Rx}}$	Power-Down Control. $\overline{\text{Tx/Rx}}$ pin enables the appropriate Tx or Rx path in the half-duplex mode. Logic low disables the Tx path and enables the Rx path. Logic high disables the Rx path and enables the Tx path.

Configuring with SPI

The flexible interface can be configured with register settings. Using the register allows more device programmability. Table 15 shows the required register writes to configure the AD9863 for FD, optional FD, HD24, optional HD24, HD12, optional HD12, and clone modes. Note that for modes that use interleaved data buses, enabling 2× or 4× interpolation is required.

Table 15. Registers for Configuring SPI

Register Address	Setting	Description
FD, Mode 1		
Register 0x01 [7:5]	[000]	Clk_Mode. Configures timing mode.
Register 0x14 [4]	High	SPIFD/ $\overline{\text{HD}}$. Configures FD mode.
Register 0x14 [2]	High	SpiB12/ $\overline{24}$. Configures FD mode.
Register 0x13 [1:0]	[01] or [10]	Interpolation Control. Configures 2× or 4× interpolation.
Optional FD, Mode 2		
Register 0x01 [7:5]	[001]	Clk_Mode. Configures timing mode.
Register 0x14 [4]	High	SPIFD/ $\overline{\text{HD}}$. Configures FD mode.
Register 0x14 [2]	High	SpiB12/ $\overline{24}$. Configures FD mode.
Register 0x13 [1:0]	[01] or [10]	Interpolation Control. Configures 2× or 4× interpolation.
HD24, Mode 4		
Register 0x01 [7:5]	[000]	Clk_Mode. Configures timing mode.
Register 0x14 [4]	Low	SPIFD/ $\overline{\text{HD}}$. Configures HD mode.
Register 0x14 [2]	Low	SpiB12/ $\overline{24}$. Configures HD24 mode.
Register 0x13 [1:0]	[00], [01], or [10]	Interpolation Control. Configures 1×, 2×, or 4× interpolation.
Optional HD24, Mode 5		
Register 0x01 [7:5]	[011]	Clk_Mode. Configures timing mode.
Register 0x14 [4]	Low	SPIFD/ $\overline{\text{HD}}$. Configures HD mode.
Register 0x14 [2]	Low	SpiB12/ $\overline{24}$. Configures HD24 mode.
Register 0x13 [1:0]	[00], [01], or [10]	Interpolation Control. Configures 1×, 2×, or 4× interpolation.
HD12, Mode 7		
Register 0x01 [7:5]	[000]	Clk_Mode. Configures timing mode.
Register 0x14 [4]	Low	SPIFD/ $\overline{\text{HD}}$. Configures HD mode.
Register 0x14 [2]	High	SpiB12/ $\overline{24}$. Configures HD12 mode.
Register 0x13 [1:0]	[01] or [10]	Interpolation Control. Configures 2× or 4× interpolation.
Optional HD12, Mode 8		
Register 0x01 [7:5]	[101]	Clk_Mode. Configures timing mode.
Register 0x14 [4]	Low	SPIFD/ $\overline{\text{HD}}$. Configures HD mode.
Register 0x14 [2]	High	SpiB12/ $\overline{24}$. Configures HD12 mode.
Register 0x13 [1:0]	[01] or [10]	Interpolation Control. Configures 2× or 4× interpolation.
Clone, Mode 10		
Register 0x01 [7:5]	[111]	Clk_Mode. Configures timing mode.
Register 0x14 [0]	High	SpiClone. Configures clone mode.
Register 0x13 [1:0]	[01] or [10]	Interpolation Control. Configures 2× or 4× interpolation.

SPI Register Map

Registers 0x00 to 0x29 of the AD9863 provide flexible operation of the device. The SPI allows access to many configurable options. Detailed descriptions of the bit functions are found in Table 17.

Table 16. Register Map

Reg. Name	Reg. Add	7	6	5	4	3	2	1	0
General	0x00	SDIO BiDir	LSB first	Soft reset					
Clock Mode	0x01	clk_mode [2:0]					Enable IFACE2 clkout	Inv clkout (IFACE3)	
Power-Down	0x02	Tx analog			Tx digital	Rx digital	PLL power-down	PLL output disconnect	
RxA Power-Down	0x03	Rx_A analog	Rx_A DC bias						
RxB Power-Down	0x04	Rx_B analog	Rx_B DC bias						
Rx Power-Down	0x05	Rx analog bias	RxRef	DiffRef	VREF				
Rx Path	0x06			Rx_A twos complement	Rx_A Clk Duty				
Rx Path	0x07			Rx_B twos complement	Rx_B Clk Duty				
Rx Path	0x08					Rx ultralow power control	Rx ultralow power control		
Rx path	0x09		Rx ultralow power control	Rx ultralow power control	Rx ultralow power control				
Rx Path	0x0A		Rx ultralow power control	Rx ultralow power control	Rx ultralow power control				
Tx Path	0B	DAC A offset [9:2]							
Tx Path	0C	DAC A offset [1:0]							DAC A offset direction
Tx Path	0D	DAC A coarse gain control		DAC A fine gain [5:0]					
Tx Path	0E	DAC B offset [9:2]							
Tx Path	0F	DAC B offset [1:0]							DAC B offset direction
Tx Path	10	DAC B coarse gain control		DAC B fine gain [5:0]					
Tx Path	11	TxPGA gain [7:0]							
Tx Path	12		TxPGA slave enable		TxPGA fast update				
I/O Configuration	13	Tx twos complement	Rx twos complement	Tx inverse sample				Interpolation control [1:0]	
I/O Configuration	14			Dig loop on	SpiFD/HD	SpiTx/Rx	SpiB12/24	SPI IO control	SpiClone
Clock	15	PLL bypass		ADC clock div	Alt timing mode	PLL Div5	PLL multiplier [2:0]		
Clock	16			PLL to IFACE2			PLL slow		

Table 17. Register Bit Descriptions

Register Bit	Description																		
Register 0x00: General																			
Bit 7: SDIO BiDir (Bidirectional)	Default setting is low, which indicates that the SPI serial port uses dedicated input and output lines (4-wire interface), SDIO pins and SDO pins, respectively. Setting this bit high configures the serial port to use the SDIO pin as a bidirectional data pin.																		
Bit 6: LSB First	Default setting is low, which indicates MSB first SPI port access mode. Setting this bit high configures the SPI port access to LSB first mode.																		
Bit 5: Soft Reset	Writing a high to this register resets all the registers to their default values and forces the PLL to relock to the input clock. The soft reset bit is a one-shot register and is cleared immediately after the register write is completed.																		
Register 0x01: Clock Mode																			
Bit 7 to Bit 5: Clk_Mode	These bits represent the clocking interface for the various modes. Setting 000 is default. Setting 111 is used for clone mode. Refer to the Summary of Flexible I/O Modes section for a definition of clone mode.																		
	<table border="0"> <thead> <tr> <th>Setting</th> <th>Mode</th> </tr> </thead> <tbody> <tr> <td>000</td> <td>Standard FD, HD12, HD24 Clock (Modes 1, 4, 7)</td> </tr> <tr> <td>001</td> <td>Optional FD timing (Mode 2)</td> </tr> <tr> <td>010</td> <td>Not used</td> </tr> <tr> <td>011</td> <td>Optional HD24 timing (Mode 5)</td> </tr> <tr> <td>100</td> <td>Not used</td> </tr> <tr> <td>101</td> <td>Optional HD12 timing (Mode 8)</td> </tr> <tr> <td>110</td> <td>Not used</td> </tr> <tr> <td>111</td> <td>Clone Mode (Mode 10)</td> </tr> </tbody> </table>	Setting	Mode	000	Standard FD, HD12, HD24 Clock (Modes 1, 4, 7)	001	Optional FD timing (Mode 2)	010	Not used	011	Optional HD24 timing (Mode 5)	100	Not used	101	Optional HD12 timing (Mode 8)	110	Not used	111	Clone Mode (Mode 10)
Setting	Mode																		
000	Standard FD, HD12, HD24 Clock (Modes 1, 4, 7)																		
001	Optional FD timing (Mode 2)																		
010	Not used																		
011	Optional HD24 timing (Mode 5)																		
100	Not used																		
101	Optional HD12 timing (Mode 8)																		
110	Not used																		
111	Clone Mode (Mode 10)																		
Bit 2: Enable IFACE2 clkout	Enables the IFACE2 port to be an output clock. Also inverts the IFACE2 output clock in full-duplex mode.																		
Bit 1: Inv clkout (IFACE3)	Inverts the output clock on IFACE3.																		
Register 0x02: Power-Down																			
Bit 7 to Bit 5: Tx Analog (Power-Down)	Three options are available to reduce analog power consumption for the Tx channels. The first two options disable the analog output from Tx Channel A or B independently, and the third option disables the output of both channels and reduces the power consumption of some of the additional analog support circuitry for maximum power savings. With all three options, the DAC bias current is not powered down, so recovery times are fast (typically a few clock cycles). The list below explains the different modes and settings used to configure them.																		
	<table border="0"> <tbody> <tr> <td>Power-down option bits setting [7:5]</td> <td></td> </tr> <tr> <td>Power-down Tx A channel analog output [1 0 0]</td> <td></td> </tr> <tr> <td>Power-down Tx B channel analog output [0 1 0]</td> <td></td> </tr> <tr> <td>Power-down Tx A and Tx B analog outputs [1 1 1]</td> <td></td> </tr> </tbody> </table>	Power-down option bits setting [7:5]		Power-down Tx A channel analog output [1 0 0]		Power-down Tx B channel analog output [0 1 0]		Power-down Tx A and Tx B analog outputs [1 1 1]											
Power-down option bits setting [7:5]																			
Power-down Tx A channel analog output [1 0 0]																			
Power-down Tx B channel analog output [0 1 0]																			
Power-down Tx A and Tx B analog outputs [1 1 1]																			
Bit 4: Tx Digital (Power-Down)	Default is low, which enables the digital section of the transmit path to operate as programmed through other registers. By setting this bit high, the digital blocks are not clocked to reduce power consumption. When enabled, the Tx outputs are static, holding their last update values.																		
Bit 3: Rx Digital (Power-Down)	Setting this bit high powers down the digital section of the receive path of the chip. Typically, any unused digital blocks are automatically powered down.																		
Bit 2: PLL Power-Down	Setting this register bit high forces the CLKIN2 PLL multiplier to a power-down state. This mode can be used to conserve power or to bypass the internal PLL. To operate the AD9863 when the PLL is bypassed, CLKIN2 must be supplied with a clock equal to the fastest Tx path clock.																		
Bit 1: PLL Output Disconnect	Setting this register bit high disconnects the PLL output from the clock path. If the PLL is enabled, it locks or stays locked as normal.																		
Register 0x03/04: Rx Power-Down																			
Bit 7: Rx_A Analog/ Rx_B Analog (Power-Down)	Either ADC or both ADCs can be powered down by setting the appropriate register bit high. The entire analog circuitry of the Rx channel is powered down, including the differential references, input buffer, and the internal digital block. The band gap reference remains active for quick recovery.																		
Bit 6: Rx_A DC Bias/ Rx_B DC Bias (Power-Down)	Setting either of these bits high powers down the input common-mode bias network for the respective channel and requires an input signal to be properly dc-biased. By default, these bits are low, and the Rx inputs are self-biased to approximately AVDD/2 and accept an ac-coupled input.																		
Register 0x05: Rx Power-Down																			
Bit 7: Rx Analog Bias (Power-Down)	Setting this bit high powers down all analog bias circuits related to the receive path (including the differential reference buffer). Because bias circuits are powered down, there is an additional power																		

Register Bit	Description										
Bit 6: RxREF (Power-Down)	saving, but also a longer recovery time relative to other Rx power-down options.										
Bit 5: DiffRef (Power-Down)	Setting this register bit high powers down internal ADC reference circuits. Powering down these circuits provides additional power saving over other power-down modes. The Rx path wake-up time depends on the recovery of these references, typically of the order of a few milliseconds.										
Bit 4: VREF (Power-Down)	Setting this bit high powers down the ADC's differential references, REFT and REFB. Recovery time depends on the value of the REFT and REFB decoupling capacitors.										
Bit 4: VREF (Power-Down)	Setting this register bit high powers down the ADC reference circuit, VREF. Powering down the Rx band gap reference allows an external reference to drive the VREF pin setting full-scale range of the Rx paths.										
Registers 0x06/0x07: Rx Path											
Bit 5: Rx_A Twos Complement/ Rx_B Twos Complement	Default data format for the Rx data is straight binary. Setting this bit high generates twos complement data.										
Bit 4: Rx_A Clk Duty/Rx_B Clk Duty	Setting either of these bits high enables the respective channels of the on-chip duty cycle stabilizer (DCS) circuit to generate the internal clock for the Rx block. This option is useful for adjusting for high speed input clocks with skewed duty cycles. The DCS mode can be used with ADC sampling frequencies over 40 MHz.										
Registers 0x08/0x09/0x0A: Rx Path Rx Ultralow Power Control Bits	Set all bits high, in combination with asserting the ADC_LO_PWR pin, to reduce the power consumption of the Rx path by a fourth of normal Rx path power consumption.										
Registers 0x0B/0x0C/0x0E/0x0F: Tx Path											
DAC A/DAC B Offset	These 10-bit, twos complement registers control a dc current offset that is combined with the Tx A or Tx B output signal. An offset current of up to $\pm 12\%$ IOUTFS (2.4 mA for a 20 mA full-scale output) can be applied to either differential pin on each channel. The offset current can be used to compensate for offsets that are present in an external mixer stage, reducing LO leakage at its output. The default setting is 0x00, no offset current. The offset current magnitude is set by using the lower nine bits. Setting the MSB high adds the offset current to the selected differential pin, while setting the MSB low subtracts the offset value.										
DAC A/DAC B Offset Direction	This bit determines to which differential output pin the offset current is applied for the selected channel. Setting this bit low applies the offset to the negative differential pin. Setting this bit high applies the offset to the positive differential pin.										
Register 0x0D/0x10: Tx Path											
Bit 7, Bit 6: DAC A/DAC B Coarse Gain Control	These register bits scale the full-scale output current (IOUTFS) of either Tx channel independently. IOUT of the Tx channels is a function of the RSET resistor, the TxPGA setting, and the coarse gain control setting. <table border="0"> <tr> <td>00</td> <td>Output current scaling by 1/11</td> </tr> <tr> <td>01</td> <td>Output current scaling by $\frac{1}{2}$</td> </tr> <tr> <td>10</td> <td>No output current scaling</td> </tr> <tr> <td>11</td> <td>No output current scaling</td> </tr> </table>	00	Output current scaling by 1/11	01	Output current scaling by $\frac{1}{2}$	10	No output current scaling	11	No output current scaling		
00	Output current scaling by 1/11										
01	Output current scaling by $\frac{1}{2}$										
10	No output current scaling										
11	No output current scaling										
Bit 5 to Bit 0: DAC A/DAC B Fine Gain	The DAC output curve can be adjusted fractionally through the gain trim control. Gain trim of up to $\pm 4\%$ can be achieved on each channel individually. The gain trim register bits are a twos complement attention control word.										
MSB, LSB	<table border="0"> <tr> <td>100000</td> <td>Maximum positive gain adjustment</td> </tr> <tr> <td>111111</td> <td>Minimum positive gain adjustment</td> </tr> <tr> <td>000000</td> <td>No adjustment (default)</td> </tr> <tr> <td>000001</td> <td>Minimum negative gain adjustment</td> </tr> <tr> <td>011111</td> <td>Maximum negative gain adjustment</td> </tr> </table>	100000	Maximum positive gain adjustment	111111	Minimum positive gain adjustment	000000	No adjustment (default)	000001	Minimum negative gain adjustment	011111	Maximum negative gain adjustment
100000	Maximum positive gain adjustment										
111111	Minimum positive gain adjustment										
000000	No adjustment (default)										
000001	Minimum negative gain adjustment										
011111	Maximum negative gain adjustment										
Register 0x11: Tx Path											
Bit 0 to Bit 7: TxPGA Gain	This 8-bit, straight binary (Bit 0 is the LSB, Bit 7 is the MSB) register control for the Tx programmable gain amplifier (TxPGA). The TxPGA provides a 20 dB continuous gain range with 0.1 dB steps (linear in dB) simultaneously to both Tx channels. By default, this register setting is 0xFF.										
MSB, LSB	<table border="0"> <tr> <td>0000 0000</td> <td>Minimum gain scaling -20 dB</td> </tr> <tr> <td>1111 1111</td> <td>Maximum gain scaling 0 dB</td> </tr> </table>	0000 0000	Minimum gain scaling -20 dB	1111 1111	Maximum gain scaling 0 dB						
0000 0000	Minimum gain scaling -20 dB										
1111 1111	Maximum gain scaling 0 dB										
Register 0x12: Tx Path											
Bit 6: TxPGA Slave Enable	The TxPGA gain is controlled through register TxPGA gain setting and, by default, is updated immediately after the register write. If this bit is set, the TxPGA gain update is synchronized with the falling edge of a signal applied to the TxPwrDwn pin and is enabled during the wake-up from power-down.										

Register Bit	Description												
Bit 4: TxPGA Fast Update (Mode)	The TxPGA fast bit controls the update speed of the TxPGA. When fast update mode is enabled, the TxPGA provides fast gain settling within a few clock cycles, which may introduce spurious signals at the output of the Tx path. The default setting for this bit is low, and the TxPGA gives a smooth transition between gain settings. Fast mode is enabled when this bit is set high.												
Register 0x13: I/O Configuration													
Bit 7: Tx Twos Complement	The default data format for Tx data is straight binary. Set this bit high when providing twos complement Tx data.												
Bit 6: Rx Twos Complement	The default data format for Rx data is straight binary. Set this bit high when providing twos complement Rx data.												
Bit 5: Tx Inverse Sample	By default, the transmit data is sampled on the rising edge of the CLKOUT. Setting this bit high changes this, and the transmit data are sampled on the falling edge.												
Bit 1, Bit 0: Interpolation Control	These register bits control the interpolation rate of the transmit path. The default settings are both bits low, indicating that both interpolation filters are bypassed. The MSB and LSB are Address Bit 1 and Address Bit 0, respectively. Setting binary 01 provides an interpolation rate of 2 \times ; binary 10 provides an interpolation rate of 4 \times .												
Register 0x14: I/O Configuration													
Bit 5: Dig Loop On	When enabled, this bit enables a digital loop-back mode. The digital loop-back mode provides a means of testing digital interfaces and functionality at the system level. In digital loop-back mode, the full-duplex interface must be enabled. (Refer to the Flexible I/O Interface Options section.) The device accepts data from the digital input bus according to the FD mode timing, and the data is processed by using the Tx digital path (including any enabled interpolation filter). The processed data is then output from the Rx path bus.												
Bit 4: SPIFD/ $\overline{\text{HD}}$	Control bit to configure full-duplex (high) or half-duplex (low) interface mode. This register, in combination with the SpiB12/24 register, configures the interface mode of FD, HD12, or HD24. The register setting is ignored for clone mode operation. By default, this register is set high, and the device is in FD mode.												
Bit 3: SpiTx/ $\overline{\text{Rx}}$	Control bit for transmit or receive mode for the half-duplex clock modes. High represents Tx and low represents Rx.												
Bit 2: SpiB12/ $\overline{24}$	Control bit for 12-bit or 24-bit modes. High represents 12-bit mode and low represents 24-bit mode.												
Bit 1: SPI IO Control	Use in conjunction with SpiTx/ $\overline{\text{Rx}}$ [Register14, Bit 3] to override external Tx/ $\overline{\text{Rx}}$ pin operation.												
Bit 0: SpiClone	Set high when in clone mode (see Flexible I/O Interface Options section for definition of clone mode). Clk_mode must also be set to Binary 111, such as [Register 01[7:5] = 111.												
Register 0x15: Clock													
Bit 7: PLL_Bypass	Setting this bit high bypasses the PLL. When bypassed, the PLL remains active.												
Bit 5: ADC Clock Div	By default the ADCs are driven directly from CLKIN1 in normal timing operation or from the PLL output clock in the alternative timing operation. This bit is used to divide the source of the ADC clock prior to the ADCs. The default setting is low and performs no division. Setting this bit high divides the clock by 2.												
Bit 4: Alt Timing Mode	Table 5 describes two timing modes: the normal timing operation mode and the alternative timing operation mode. The default configuration is normal timing mode, and the CLKIN1 drives the Rx path. In alternative timing mode, the PLL output is used to drive the Rx path. The alternative operation mode is configured by setting this bit high.												
Bit 3: PLL Div5	The output of the PLL can be divided by 5 by setting this bit high. By default, the PLL directly drives the Tx digital path with no division of its output.												
Bit 2 to Bit 0: PLL Multiplier	These bits control the PLL multiplication factor. A default setting is Binary 000, which configures the PLL to 1 \times multiplication factor. This register, in combination with the PLL Div5 register, sets the PLL output frequency. The programmable multiplication factors are												
	<table> <tbody> <tr> <td>000</td> <td>1\times</td> </tr> <tr> <td>001</td> <td>2\times</td> </tr> <tr> <td>010</td> <td>4\times</td> </tr> <tr> <td>011</td> <td>8\times</td> </tr> <tr> <td>100</td> <td>16\times</td> </tr> <tr> <td>101 to 111</td> <td>not used</td> </tr> </tbody> </table>	000	1 \times	001	2 \times	010	4 \times	011	8 \times	100	16 \times	101 to 111	not used
000	1 \times												
001	2 \times												
010	4 \times												
011	8 \times												
100	16 \times												
101 to 111	not used												
Register 0x16: Clock													
Bit 5: PLL to IFACE2	Setting this bit high switches the IFACE2 output signal to the PLL output clock. It is valid only if Register 0x01, Bit 2 is enabled or if full-duplex mode is configured.												
Bit 2: PLL Slow	Changes the PLL loop bandwidth; changes profile of the phase noise generated from the PLL clock.												

PROGRAMMABLE REGISTERS

The AD9863 contains internal registers that are used to configure the device. A serial port interface provides read/write access to the internal registers. Single-byte or dual-byte transfers are supported, as well as MSB first or LSB first transfer formats. The AD9863's serial interface port can be configured as a single pin I/O (SDIO) or as two unidirectional pins for in/out (SDIO/SDO). The serial port is a flexible, serial communications port, allowing easy interface to many industry-standard microcontrollers and microprocessors.

General Operation of the Serial Interface

By default, the serial port accepts data in MSB first mode and uses four pins: SEN, SCLK, SDIO, and SDO, by default. SEN is a serial clock enable pin; SCLK is the serial clock pin; SDIO is a bidirectional data line; and SDO is a serial output pin.

SEN is an active low control gating read and write cycles. When SEN is high, SDO and SDIO go into a high impedance state.

SCLK is used to synchronize SPI reads and writes at a maximum bit rate of 30 MHz. Input data is registered on the rising edge, and output data transitions are registered on the falling edge. During write operations, the registers are updated after the 16th rising clock edge (and 24th rising clock edge for the dual-byte case). Incomplete write operations are ignored.

SDIO is an input data only pin by default. Optionally, a 3-pin interface may be configured using the SDIO for both input and output operations and three-stating the SDO pin. Refer to the SDIO BiDir bit in Register 0x00 shown in Table 17.

SDO is a serial output data pin used for readback operations in 4-wire mode and is three-stated when SDIO is configured for bidirectional operation.

There are two phases to a communication cycle with the AD9863. Phase 1 is the instruction cycle, which is the writing of an instruction byte into the AD9863, coincident with the first eight SCLK rising edges. The instruction byte provides the AD9863 serial port controller with information regarding the data transfer cycle, which is Phase 2 of the communication cycle. The Phase 1 instruction byte defines whether the upcoming data transfer is read or write, the number of bytes in the data transfer (one or two), and the starting register address for the first byte of the data transfer.

The first eight SCLK rising edges of each communication cycle are used to write the instruction byte into the AD9863. The remaining SCLK edges are for Phase 2 of the communication cycle. Phase 2 is the actual data transfer between the AD9863 and the system controller. Phase 2 of the communication cycle is a transfer of one or two data bytes as determined by the instruction byte. Normally, using one communication cycle in a multibyte transfer is the preferred method; however, single byte communication cycles are useful to reduce CPU overhead when register access requires only one byte. An example of this is to write the AD9863 power-down bits.

All data input to the AD9863 is registered on the rising edge of SCLK. All data is driven out of the AD9863 on the falling edge of SCLK.

Instruction Byte

The instruction byte contains the information shown in Table 18, and the bits are described in detail after the table.

Table 18. Instruction Byte

MSB	D6	D5	D4	D3	D2	D1	LSB
R/W	2/1	A5	A4	A3	A2	A1	A0
	Byte						

R/W—Bit 7 of the instruction byte determines whether a read or write data transfer will occur after the instruction byte write. Logic high indicates a read operation. Logic low indicates a write operation.

2/1 Byte—Bit 6 of the instruction byte determines the number of bytes to be transferred during the data transfer cycle of the communication cycle. Logic high indicates a 2-byte transfer. Logic low indicates a 1-byte transfer.

A5, A4, A3, A2, A1, A0—Bit 5 to Bit 0 of the instruction byte determine which register is accessed during the data transfer portion of the communication cycle. For 2-byte transfers, this address is the starting byte address. The second byte address is automatically decremented when the interface is configured for MSB-first transfers. For LSB-first transfers, the address of the second byte is automatically incremented.

Table 19. Serial Port Interface Timing

Maximum SCLK Frequency (f_{SCLK})	40 MHz
Minimum SCLK High Pulse Width (t_{PWH})	12.5 ns
Minimum SCLK Low Pulse Width (t_{PWL})	12.5 ns
Maximum Clock Rise/Fall Time	1 ms
Data to SCLK timing (t_{DS})	12.5 ns
Data Hold Time (t_{DH})	0 ns

Write Operations

The SPI write operation uses the instruction header to configure a 1-byte or 2-byte register write using the 2/1̄ byte setting. The instruction byte followed by the register data is written serially into the device through the SDIO pin on rising edges of the interface clock, SCLK. The data can be transferred MSB first or LSB first, depending on the setting of the LSB-first register bit. The write operation is the same, regardless of SDIO BiDir register setting.

Note the differences between LSB- and MSB-first modes: both the instruction header and data are reversed, and the second data byte register location is different. In the default MSB-first mode, the second data byte is written to a decremented register address. In LSB-first mode, the second data byte is written to an incremented register address.

Figure 52 to Figure 54 are examples of writing data into the device. Figure 52 shows a 1-byte write in MSB-first mode; Figure 53 shows a 2-byte write in MSB-first mode; and Figure 54 shows a 2-byte write in LSB-first mode.

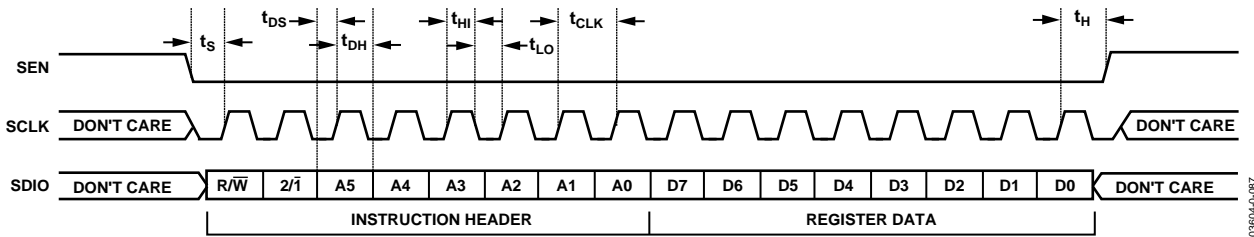

Figure 52. 1-Byte Serial Register Write in MSB-First Mode

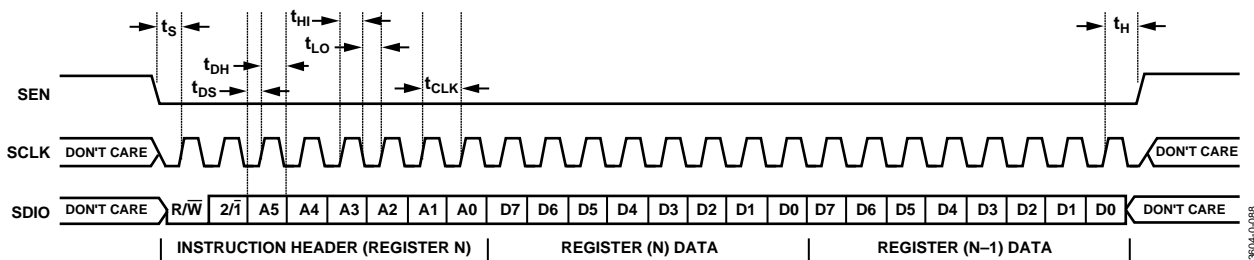

Figure 53. 2-Byte Serial Register Write in MS-First Mode

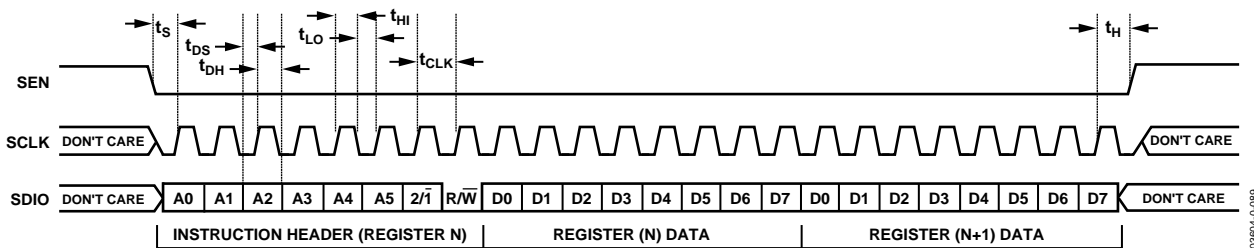

Figure 54. 2-Byte Serial Register Write in LSB-First Mode

Read Operations

The readback of registers can be a single or dual data byte operation. The readback can be configured to use 3-wire or 4-wire and can be formatted with MSB first or LSB first. The instruction header is written to the device either MSB or LSB first (depending on the mode) followed by the 8-bit output data, appropriately MSB or LSB justified. By default, the output data is sent to the dedicated output pin (SDO).

Three-wire operation can be configured by setting the SDIO BiDir register. In 3-wire mode, the SDIO pin will become an output pin after receiving the 8-bit instruction header with a readback request.

Figure 55 shows 4-wire SPI read with MSB first; Figure 56 shows 3-wire read with MSB first; and Figure 57 shows 4-wire read with LSB first.

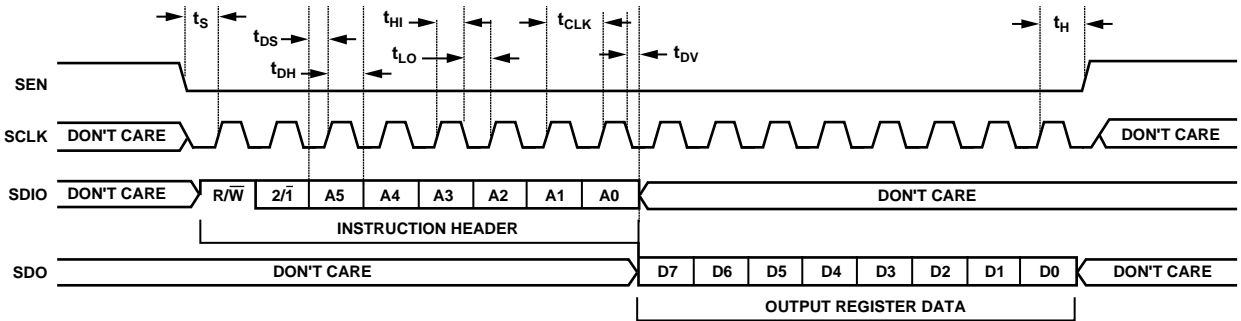

Figure 55. 1-Byte Serial Register Readback in MSB First Mode, SDIO BiDir Bit Set Logic Low (Default, 4-Wire Mode)

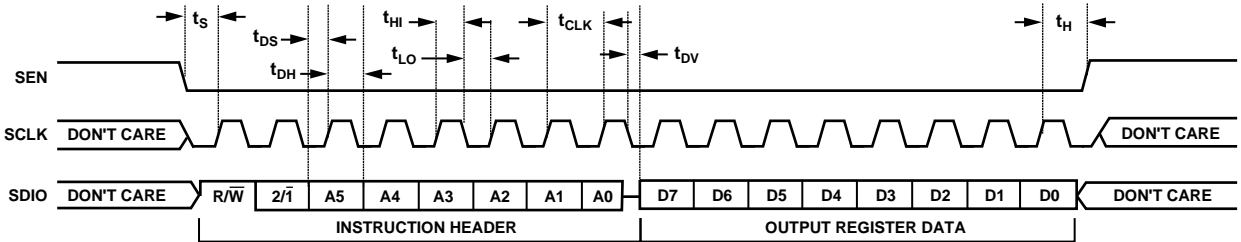

Figure 56. 1-Byte Serial Register Readback in MSB First Mode, SDIO BiDir Bit Set Logic High (Default, 3-Wire Mode)

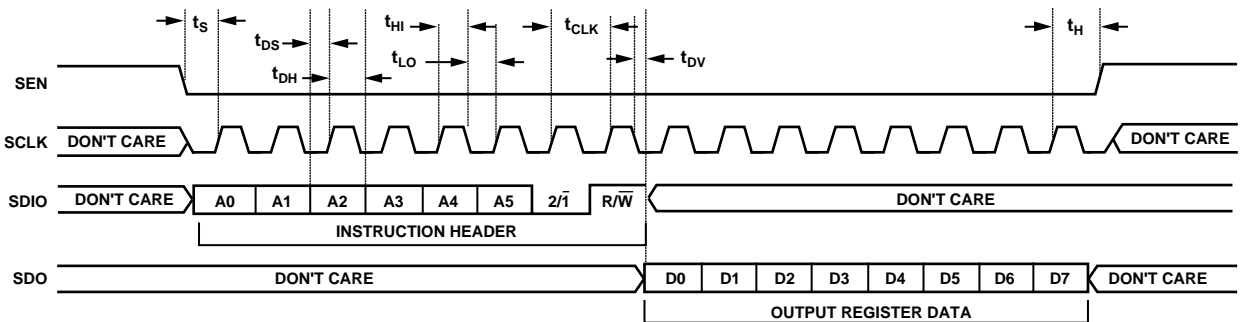

Figure 57. 1-Byte Serial Register Readback in LSB First Mode, SDIO BiDir Bit Set Logic Low (Default, 4-Wire Mode)

CLOCK DISTRIBUTION BLOCK

Theory/Description

The AD9863 uses a PLL clock multiplier circuit and an internal distribution block to generate all required clocks for various timing configurations. The AD9863 has two independent input clocks, CLKIN1 and CLKIN2. The CLKIN1 is primarily used to drive the Rx ADCs path. The CLKIN2 is primarily used to drive the Tx DACs path. There are many options for configuring the clock distribution block, which are programmed through internal register settings. The Clock Distribution Block Diagram section describes the timing block diagram breakdown, followed by the data timing for the different data interface options.

The clock distribution block contains a PLL, which includes an optional output divide-by-5 circuit, an ADC divide-by-2 circuit, multiplexers, and other digital logic.

There are two main methods of configuring the Rx path timing of the AD9863: normal timing mode and alternate timing mode, which are controlled through Register 0x15, Bit 4. In normal timing mode, the Rx path clock is driven directly from the CLKIN1 input, and the Tx path is driven by a clock derived from CLKIN2 multiplied by the on-chip PLL. In alternative timing mode, the CLKIN2 drives the PLL circuitry, and the PLL output clock drives both the Rx path clock and Tx path clock.

Because alternate timing mode uses the PLL to derive the Rx path clock, the ADC performance may degrade slightly. This degradation is due to the phase noise from the PLL, although typically it is only noticeable in undersampling applications when the input signal is above the first Nyquist zone of the ADC.

The PLL can provide 1×, 2×, 4×, 8×, and 16× multiplication or can be bypassed and powered down through register PLL bypass [Register 0x15, Bit 7] and through register PLL power-down [Register 0x02, Bit 2]. The PLL requires a minimum input clock frequency of 16 MHz and needs to provide a minimum PLL output clock of 32 MHz. This limit applies to the PLL output prior to the optional divide-by-5 circuitry. For clock frequencies below these limits, the PLL must be bypassed. The PLL maximum output frequency before the divide-by-5 circuitry is 350 MHz. Table 20 shows the input and output clock rates for all the multiplication settings.

Table 20. PLL Input and Output Minimum and Maximum Clock Rates

PLL Setting	CLKIN2 Input (Min/Max) (MHz)	PLL Output Clock (Min/Max) (MHz)
1× (PLL Bypassed)	1 / 200	1 / 200
1× (PLL Enabled)	32 / 200	32 / 200
2×	16 / 100	32 / 200
4×	16 / 50	64 / 200
8×	16 / 25	128 / 200
1/5 × ¹	32 / 200	6.4 / 40
2/5 × ¹	16 / 175	6.4 / 70
4/5 × ¹	16 / 87.5	12.8 / 70
8/5 × ¹	16 / 43.75	25.6 / 70
16/5 × ¹	16 / 21.875	51.2 / 70

¹ Indicates PLL output divide-by-5 circuit enabled.

Clock Distribution Block Diagram

The clock distribution block diagram is shown in Figure 58.

An output clock formatter configures the output synchronization signals, IFACE1, IFACE2, and IFACE3. These interface pin signals depend on clock mode setting, data I/O configuration, and other operational settings. Clock mode and data I/O configuration are defined in register settings of clk_mode, SpiFD/H \overline{D} , and SpiB12/24.

Table 21 shows the configuration of the IFACE1, IFACE2, and IFACE3 pins relative to clock mode. For half-duplex cases, the IFACE1 pin is an input that identifies if the device is in Rx or Tx operation mode. The clock mode is used to specify the timing for each data interface operation mode, presented in detail in the Flexible I/O Interface Options section. The T and R extensions after half-duplex Modes 4 and 5, Modes 7 and 8, and Mode 10 in Table 21 indicate that the device is in transmit or receive operation mode. The default clock mode setting [Register 0x01, Bit 5 to Bit 7, Clk_Mode] of 000 configures clock Mode 1 for the full-duplex operation, Mode 4 for half-duplex 24 operation, and Mode 7 for half-duplex 12 operation. Mode 2, Mode 5, Mode 8, and Mode 10 are optional timing configurations for the AD9863 and can be programmed through Register 0x01 Clk_Mode.

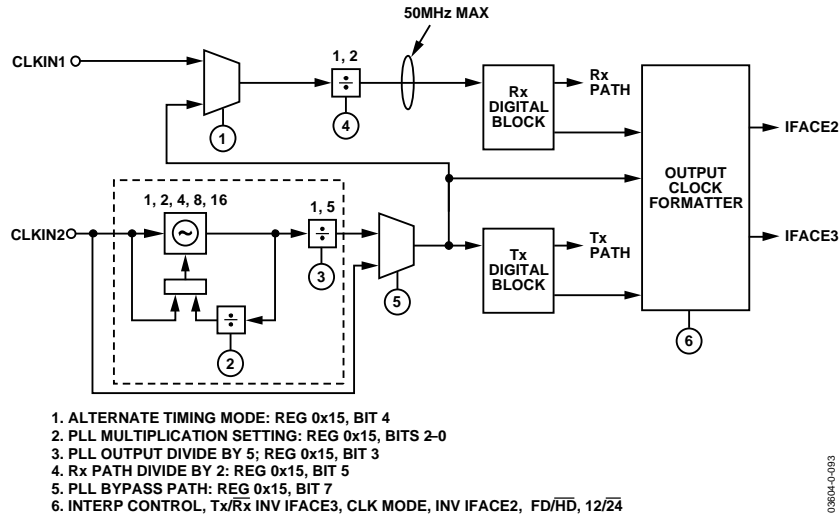

Figure 58. Clock Distribution Block Diagram

Table 21. Interface Pins (IFACE1, IFACE2, IFACE3) Configuration Definition for Flexible Interface Operation

Clock Mode Pin	1	2	4T	4R	5T	5R	7T	7R	8T	8R	10T	10R
	Full-Duplex		Half-Duplex, 24-Bit				Half-Duplex, 12-Bit				Clone Mode	
CLKIN1, CLKIN2	Independent	Internally Tied Together	Independent		Internally Tied Together		Independent		Internally Tied Together		Independent	
IFACE1	TxSync		Tx/Rx				Tx/Rx				Tx/Rx	
IFACE2	Buff_CLKIN1	RxSync	Optional CLKOUT				Optional CLKOUT				Optional CLKOUT	
IFACE3	Tx Clock		Tx Clock	Rx Clock	Tx Clock	Rx Clock	Tx Clock	Rx Clock	Tx Clock	Rx Clock	Tx Clock	Rx Clock

The Tx clock output frequency depends on whether the data is in interleaved or parallel (noninterleaved) configuration. Modes 1, 2, 7, 8, and 10 use Tx interleaved data and require either 2x or 4x interpolation to be enabled.

- DAC update rate = CLKIN2 × PLL setting.
- Noninterleaved Tx data clock frequency = CLKIN2 × PLL setting × 1/(interpolation rate).
- Interleaved Tx data clock frequency = 2 × CLKIN2 × PLL setting × 1/(interpolation rate).

The Rx clock does not depend on whether the data is interleaved or parallel, but it does depend on the configuration of the timing mode: normal or alternative.

- Normal timing mode, Rx clock frequency = CLKIN1 × ADC div factor (if enabled).
- Alternative timing mode, Rx clock frequency = CLKIN2 × PLL setting × ADC div factor (if enabled).

An optional CLKOUT from IFACE2 is available as a stable system clock running at the CLKIN1 frequency or the TxDAC update rate, which is equal to CLKIN2 × PLL setting. Setting the enable IFACE2 clkout register [Register 0x01, Bit 2] enables the IFACE2 optional clock output. In FD mode the IFACE2 pin always acts as a clock output; the enable IFACE2 pin can be used to invert the IFACE2 output.

Configuration

The AD9863 timing for the transmit path and for the receive path depend on the mode setting and various programmable options. The registers that affect the output clock timing and data input/output timing are Clk_Mode [2:0], enable IFACE2 clkout, inv clkout (IFACE3), Tx inverse sample, interpolation control, PLL bypass, ADC clock div, alt timing mode, PLL Div5, PLL multiplier, and PLL to IFACE2. The Clk_Mode register is presented previously.

Table 22 shows the other register bits that are used to configure the output clock timing and data latching options available in the AD9863.

Table 22. Serial Registers Related to the Clock Distribution Block

Register Name	Register Address, Bit(s)	Function
Enable IFACE2 clkout	Register 0x01, Bit 2	0: There is no clock output from IFACE2 pin, except in FD mode. 1: The IFACE2 pin outputs a continuous reference clock from the PLL output. In FD mode, this inverts the IFACE2 output.
Inv clkout (IFACE3)	Register 0x01, Bit 1	0: The IFACE3 clock output is not inverted. 1: The IFACE3 clock output is inverted.
Tx Inverse Sample	Register 0x13, Bit 5	0: The Tx path data is latched relative to the output Tx clock rising edge. 1: The Tx path data is latched relative to the output Tx clock falling edge.
Interpolation Control	Register 0x13, Bit 1:0	Sets interpolation of 1x, 2x, or 4x for the Tx path.
PLL_Bypass	Register 0x15, Bit 7	0: PLL block is used to generate system clock. 1: PLL block bypasses generate system clock.
ADC Clock Div	Register 0x15, Bit 5	0: ADC clock rate equals the Rx path frequency. 1: ADC clock is one-half the Rx path frequency.
Alt Timing Mode	Register 0x15, Bit 4	0: CLKIN1 is used to drive the Rx path clock. 1: PLL block output is used to drive the Rx path clock.
PLL Div5	Register 0x15, Bit 3	0: PLL block output clock is not divided down. 1: PLL block output clock is divided by 5.
PLL Multiplier	Register 0x15, Bit 2:0	Sets multiplication factor of the PLL block to 1x (000), 2x (001), 4x (010), 8x (011), or 16x (100).
PLL to IFACE2	Register 0x16, Bit 5	0: If enable IFACE2 clkout register is set, IFACE2 outputs buffered CLKIN. 1: If enable IFACE2 clkout register is set, IFACE2 outputs buffered PLL output clock.

Transmit (Tx) timing requires specific setup and hold times to properly latch data through the data interface bus. These timing parameters are specified relative to an internally generated output reference clock. The AD9863 has two interface clocks provided through the IFACE3 and IFACE2 pins. The transmit timing specifications and setup and hold times provide a minimum required window of valid data.

Setup time (t_{SETUP}) is the time required for data to initially settle to a valid logic level prior to the relative output timing edge. Hold time (t_{HOLD}) is the time after the output timing edge that valid data must remain on the data bus to be properly latched. Figure 59 shows t_{SETUP} and t_{HOLD} relative to IFACE3 falling edge. Note that in some cases negative time is specified, for example, with t_{HOLD} timing, which means that the hold time edge occurs before the relative output clock edge.

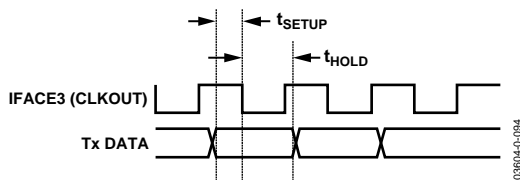

Figure 59. Tx Data Timing Diagram

Table 23 shows typical setup and hold times for the AD9863 in the various mode configurations.

Table 23. Typical Tx Data Latch Timing Relative to IFACE3 Falling Edge

Mode No.	Mode Name	t_{SETUP} (ns)	t_{HOLD} (ns)
1	FD	5	-2.5
2	Optional FD	5	-2.5
4	HD24	5	-1.5
5	Optional HD24	5	-1.5
7	HD12	5	-2.5
8	Optional HD12	5	-2.5
10	Clone	5	-1.5

Receive (Rx) path data is output after a reference output clock edge. The time delay of the Rx data relative to a reference output clock is called the output delay, t_{OD} . The AD9863 has two possible interface clocks provided through the IFACE3 and IFACE2 pins. Figure 60 shows t_{OD} relative to the IFACE3 rising edge. Note that in some cases negative time is specified, which means that the output data transition occurs prior to the relative output clock edge.

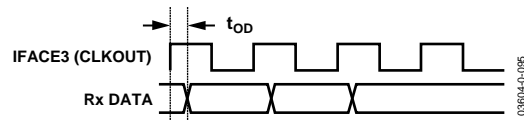

Figure 60. Rx Data Timing Diagram

Table 24 shows typical output delay times for the AD9863 in the various mode configurations.

Table 24. AD9863 Rx Data Latch Timing

Mode No.	Mode Name	t _{OD} Data Delay [ns]	Relative to:
1	FD	+2.5 ns	Relative to IFACE2 rising edge
2	Optional FD	+1 ns	Relative to IFACE3 rising edge
		+1 ns	Relative To IFACE3 rising edge
4	HD24	+2 ns	IFACE2 (RxSYNC) relative to LSB
		-1.5 ns	Relative to IFACE3 rising edge
5	Optional HD24	-0.5 ns	Relative to IFACE3 rising edge
7	HD12	-1.5 ns	Relative to IFACE3 rising edge
8	Optional HD12	+0.5 ns	Relative to IFACE3 rising edge
10	Clone	+0 ns	U12 (RxSYNC) relative to LSB
		+1.5 ns	Relative to IFACE3 rising edge

Configuration Without Serial Port Interface (Using Mode Pins)

The AD9863 can be configured using mode pins if a serial port interface is not available. This section applies only to configuring the AD9863 without an SPI. Refer to the Configuring with Mode Pins section of the data sheet for more information.

When using the mode pin option, the pins shown in Table 25 are used to configure the AD9863.

Table 25. Using Mode Pin (SPI Disabled) to Configure Timing (SPI_CS, Pin 64, Must be Tied Low)

Clock Mode	Interpolation Setting	PLL Setting	FD/HD Pin 3	12/20 Pin 17	Interp1, Interp0 Pin 1, Pin 2
Mode 1 (FD)	2×	2×	1	N/A ¹	0, 1
	4×	4×			1, 0
Mode 4 (HD24)	1×	Bypassed	0	0	0, 0
	2×	2×			0, 1
	4×	4×			1, 0
Mode 7 (HD12)	2×	2×	0	1	0, 1
	4×	4×			1, 0

¹ Pin 17 (IFACE2) is an output clock in FD mode.

OUTLINE DIMENSIONS

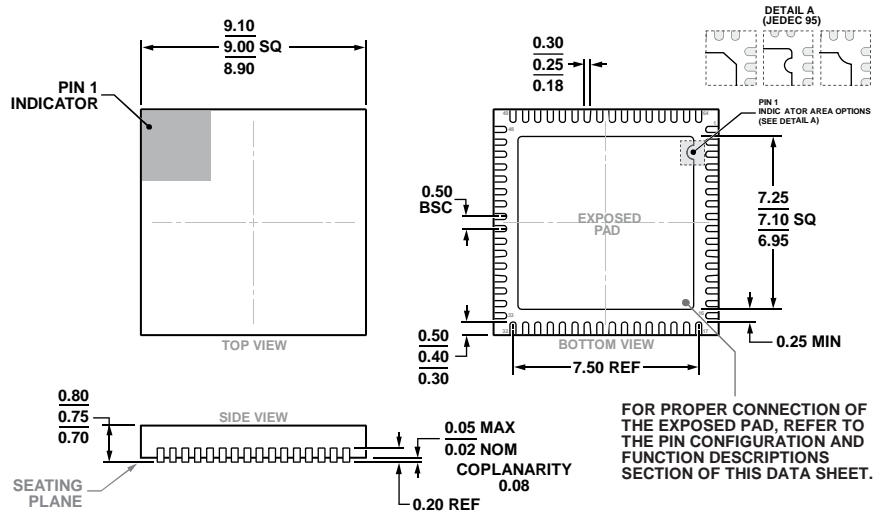

COMPLIANT TO JEDEC STANDARDS MO-220-WMMD-4.

Figure 61. 64-Lead Lead Frame Chip Scale Package [LFCSP]
9 mm × 9 mm Body and 0.75 mm Package Height
(CP-64-12)

Dimensions shown in millimeters

ORDERING GUIDE

Model ¹	Temperature Range	Package Description	Package Option
AD9863BCPZ-50	-40°C to +85°C	64-Lead LFCSP	CP-64-12
AD9863BCPZRL-50	-40°C to +85°C	64-Lead LFCSP	CP-64-12

¹ Z = Pb-free part.