

## GaAs MMIC SMT VOLTAGE-VARIABLE ATTENUATOR, DC - 8 GHz

### Typical Applications

This attenuator is ideal for use as a VVA for DC - 8 GHz applications:

- Point-to-Point Radio
- VSAT Radio

### Features

- Wide Bandwidth: DC - 8 GHz
- Low Phase Shift vs. Attenuation
- 32 dB Attenuation Range

### Functional Diagram

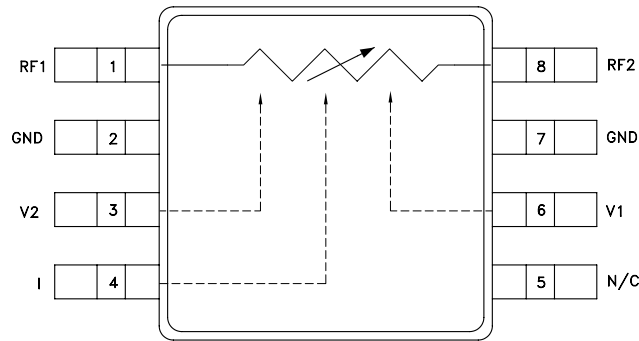

### General Description

The HMC346AMS8GE is absorptive Voltage Variable Attenuators (VVA) in 8 lead surface-mount packages operating from DC - 8 GHz. It features an on-chip reference attenuator for use with an external op-amp to provide simple single voltage attenuation control, 0 to -5V. The device is ideal in designs where an analog DC control signal must control RF signal levels over a 30 dB amplitude range. Applications include AGC circuits and temperature compensation of multiple gain stages in microwave point-to-point and VSAT radios.

### Electrical Specifications, $T_A = +25^\circ\text{C}$ , 50 Ohm system

Parameter	Min	Typical	Max	Units
Insertion Loss	DC - 8 GHz	2.1	3.1	dB
Attenuation Range	DC - 8 GHz	23	28	dB
Return Loss	DC - 8 GHz	5	10	dB
Switching Characteristics	tRISE, tFALL (10/90% RF)	8		ns
	tON, tOFF (50% CTL to 10/90% RF)	16		ns
Input Power for 0.25 dB Compression (0.5 - 8 GHz)	Min. Atten.	+8		dBm
	Atten. >2 dB	+4		dBm
Input Third Order Intercept (0.5 - 8 GHz) (Two-tone Input Power = -8 dBm Each Tone)	Min. Atten.	+30		dBm
	Atten. >2 dB	+10		dBm

# HMC346AMS8GE\* PRODUCT PAGE QUICK LINKS

Last Content Update: 08/17/2017

---

## [COMPARABLE PARTS](#)

View a parametric search of comparable parts.

## [EVALUATION KITS](#)

- HMC346AMS8G Evaluation Board

## [DOCUMENTATION](#)

### **Data Sheet**

- HMC346AMS8GE: GaAs MMIC SMT Voltage-Variable Attenuator, DC - 8 GHz Data Sheet

## [DESIGN RESOURCES](#)

- HMC346AMS8GE Material Declaration
- PCN-PDN Information
- Quality And Reliability
- Symbols and Footprints

## [DISCUSSIONS](#)

View all HMC346AMS8GE EngineerZone Discussions.

## [SAMPLE AND BUY](#)

Visit the product page to see pricing options.

## [TECHNICAL SUPPORT](#)

Submit a technical question or find your regional support number.

## [DOCUMENT FEEDBACK](#)

Submit feedback for this data sheet.

---

## GaAs MMIC SMT VOLTAGE-VARIABLE ATTENUATOR, DC - 8 GHz

**Insertion Loss vs. Temperature**

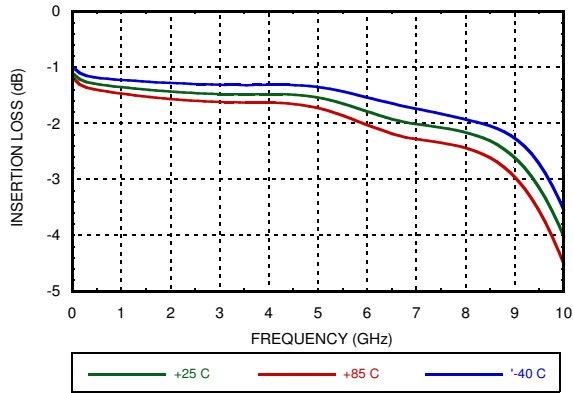

**Relative Attenuation**

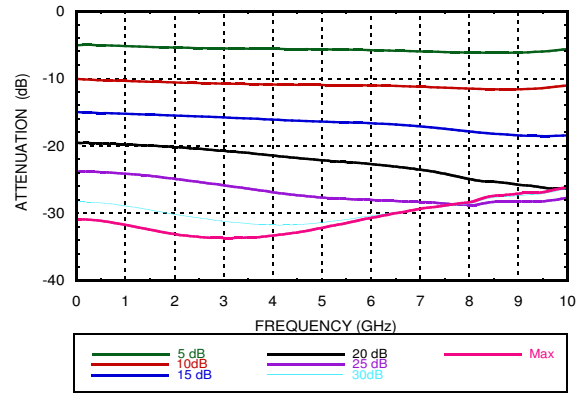

**Return Loss vs. Attenuation**

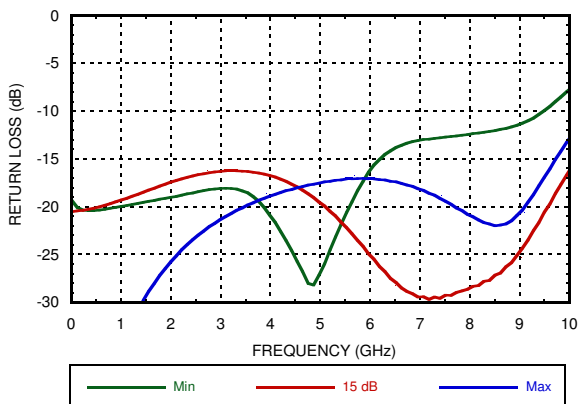

**Relative Attenuation vs. Control Voltage @ 4 GHz**

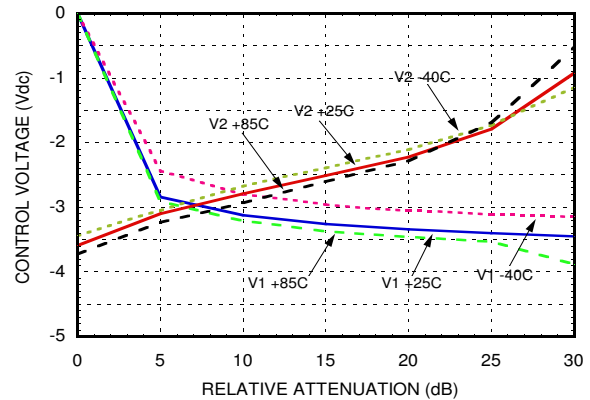

**Relative Phase**

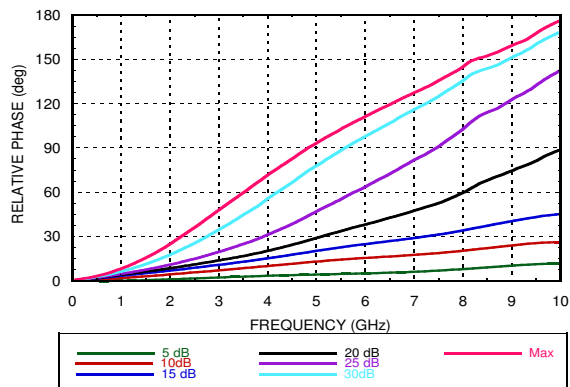

**Relative Attenuation vs. Control Voltage @ 8 GHz**

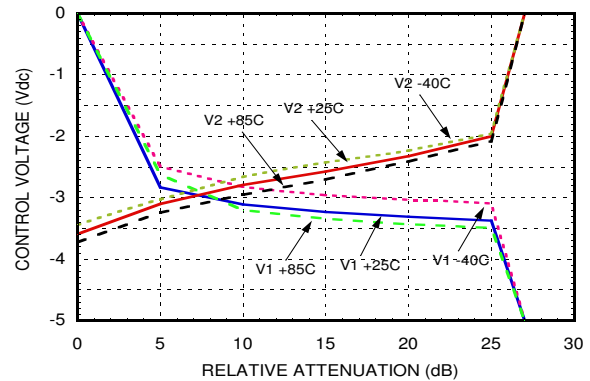

**GaAs MMIC SMT VOLTAGE-VARIABLE ATTENUATOR, DC - 8 GHz**

**Input Third Order Intercept vs Attenuation\***

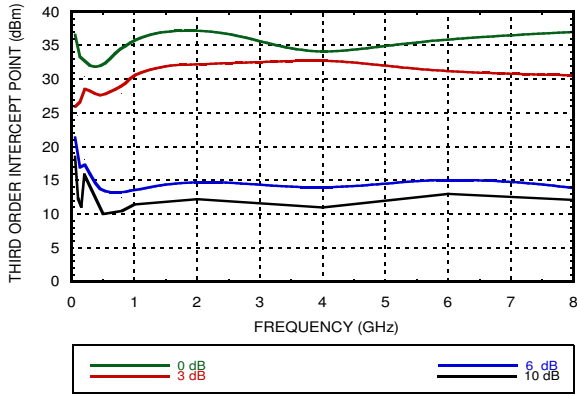

**Input Second Order Intercept vs. Attenuation\***

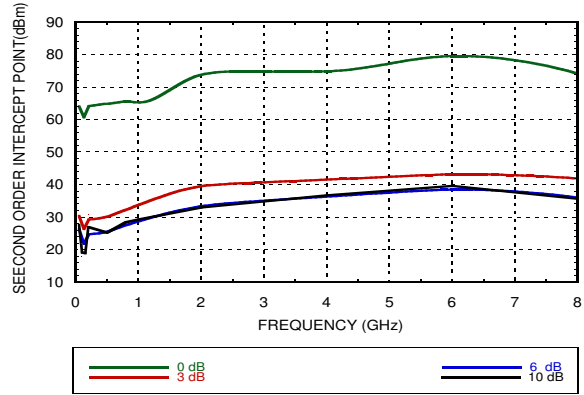

**0.25 dB Compression vs. Attenuation**

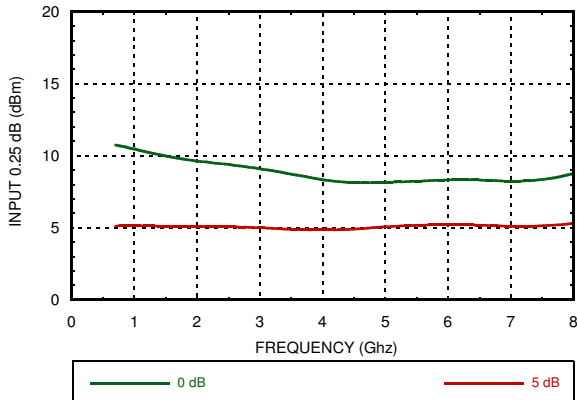

**1 dB Compression vs. Attenuation**

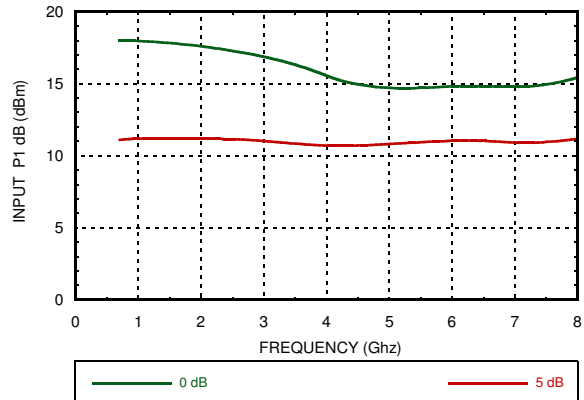

**Second Harmonic vs. Attenuation**

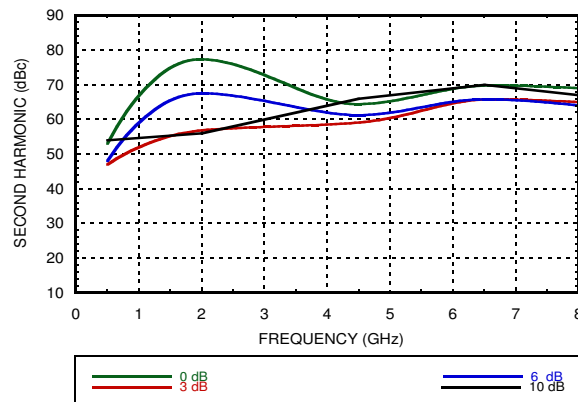

\*Two-tone input power = -8 dBm each tone, 1 MHz spacing.

## GaAs MMIC SMT VOLTAGE-VARIABLE ATTENUATOR, DC - 8 GHz

### Absolute Maximum Ratings

RF Input Power	+18 dBm
DC Voltage on I Pin	+/- 0.8V
Control Voltage Range	+0.3 to -6 V
Storage Temperature	-65 to +150 °C
Operating Temperature	-40 to +85 °C
Junction Temperature	+175 °C
Junction to Case Thermal Resistance	10 °C/W
ESD Sensitivity	Class 1 A

State	Bias Condition
V1	-5 to 0V @ 9mA typical
V2	-5 to 0V @ 9mA typical



ELECTROSTATIC SENSITIVE DEVICE  
OBSERVE HANDLING PRECAUTIONS

### Outline Drawing

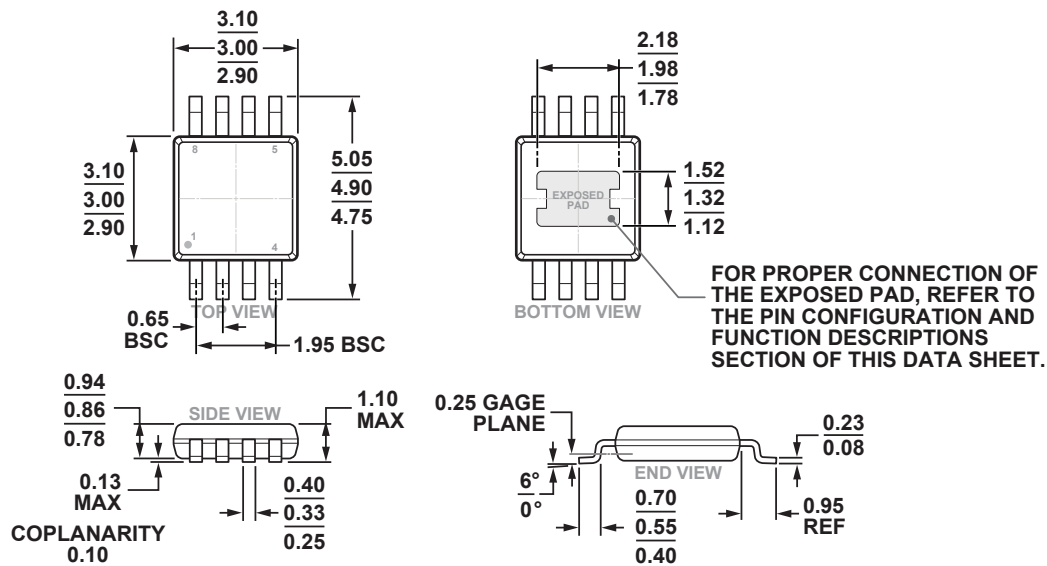

COMPLIANT TO JEDEC STANDARDS MO-187-AA-T

8-Lead Mini Small Outline Package with Exposed Pad [MINI\_SO\_EP]  
(RH-8-3)

Dimensions shown in millimeters

### Package Information



Part Number	Package Body Material	Lead Finish	MSL Rating	Package Marking <sup>[3]</sup>
HMC346AMS8GE	RoHS-compliant Low Stress Injection Molded Plastic	100% matte Sn	MSL3 <sup>[1]</sup>	H346A XXXX

[[1] Max peak reflow temperature of 260 °C

[3] 4-Digit lot number XXXX

## GaAs MMIC SMT VOLTAGE-VARIABLE ATTENUATOR, DC - 8 GHz

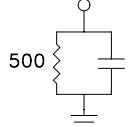
### Pin Descriptions

Pin Number	Function	Description	Interface Schematic
1, 8	RF1 RF2	This pin is DC coupled and matched to 50 Ohm. Blocking capacitors are required if RF line potential is not equal to 0V.	
2, 7	GND	This pin must be DC grounded.	
3, 6	V2, V1	Control Input (Master).	
4	I	Control Input (Slave).	
5	N/C	Not Connected.	

### Single-Line Control Driver

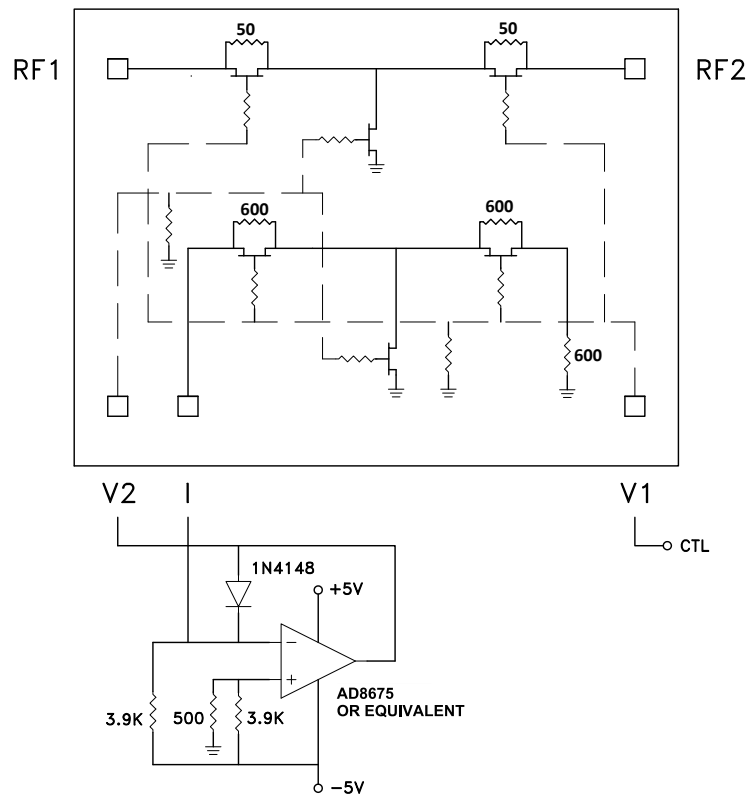

External op-amp control circuit maintains impedance match while attenuation is varied. Input control ranges from 0 Volts (min. attenuation) to -5 Volts (max. attenuation.)

**GaAs MMIC SMT VOLTAGE-VARIABLE  
ATTENUATOR, DC - 8 GHz**

**Evaluation PCB**

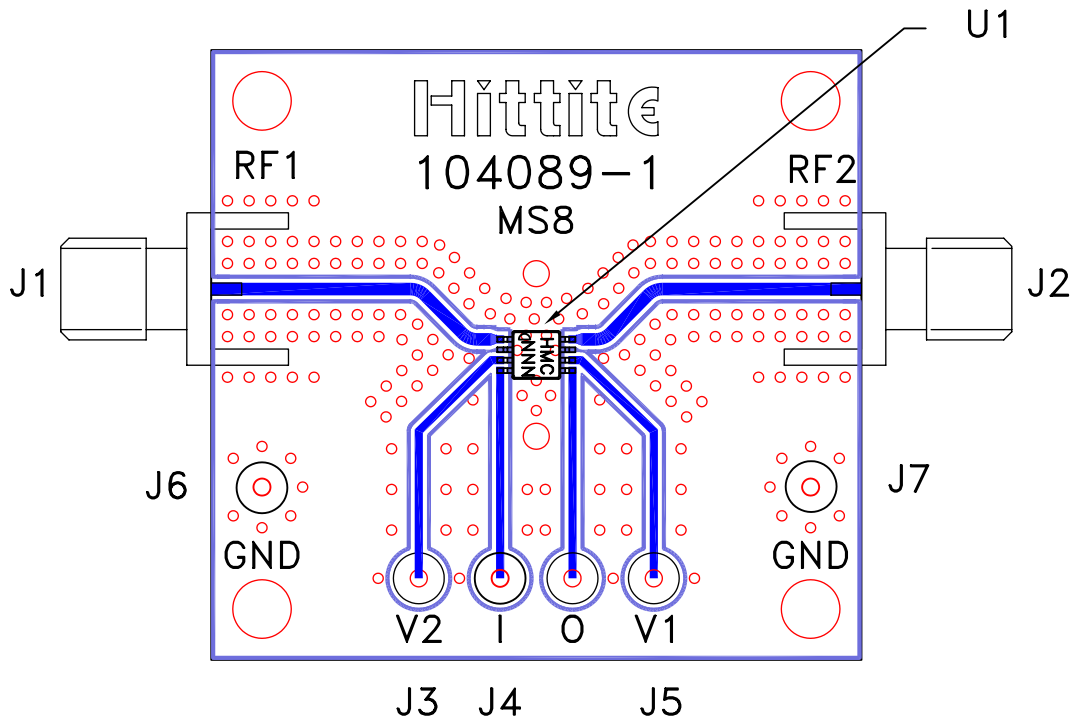

**List of Materials for Evaluation EV1HMC346AMS8G [1]**

Item	Description
J1 - J2	PCB Mount SMA RF Connector
J3 - J7	DC PIN
U1	HMC346AMS8GE
PCB [2]	104089 Eval Board

[1] Reference this number when ordering complete evaluation PCB

[2] Circuit Board Material: Rogers 4350

The circuit board used in the application should be generated with proper RF circuit design techniques. Signal lines at the RF ports should be 50 Ohm impedance and the package ground leads and package bottom should be connected directly to the PCB RF ground plane, similar to that shown above. The evaluation circuit board shown above is available from Analog Devices Inc. upon request.