



Is Now Part of



ON Semiconductor®

To learn more about ON Semiconductor, please visit our website at
www.onsemi.com

Please note: As part of the Fairchild Semiconductor integration, some of the Fairchild orderable part numbers will need to change in order to meet ON Semiconductor's system requirements. Since the ON Semiconductor product management systems do not have the ability to manage part nomenclature that utilizes an underscore (_), the underscore (_) in the Fairchild part numbers will be changed to a dash (-). This document may contain device numbers with an underscore (_). Please check the ON Semiconductor website to verify the updated device numbers. The most current and up-to-date ordering information can be found at www.onsemi.com. Please email any questions regarding the system integration to Fairchild_questions@onsemi.com.

ON Semiconductor and the ON Semiconductor logo are trademarks of Semiconductor Components Industries, LLC dba ON Semiconductor or its subsidiaries in the United States and/or other countries. ON Semiconductor owns the rights to a number of patents, trademarks, copyrights, trade secrets, and other intellectual property. A listing of ON Semiconductor's product/patent coverage may be accessed at www.onsemi.com/site/pdf/Patent-Marking.pdf. ON Semiconductor reserves the right to make changes without further notice to any products herein. ON Semiconductor makes no warranty, representation or guarantee regarding the suitability of its products for any particular purpose, nor does ON Semiconductor assume any liability arising out of the application or use of any product or circuit, and specifically disclaims any and all liability, including without limitation special, consequential or incidental damages. Buyer is responsible for its products and applications using ON Semiconductor products, including compliance with all laws, regulations and safety requirements or standards, regardless of any support or applications information provided by ON Semiconductor. "Typical" parameters which may be provided in ON Semiconductor data sheets and/or specifications can and do vary in different applications and actual performance may vary over time. All operating parameters, including "Typicals" must be validated for each customer application by customer's technical experts. ON Semiconductor does not convey any license under its patent rights nor the rights of others. ON Semiconductor products are not designed, intended, or authorized for use as a critical component in life support systems or any FDA Class 3 medical devices or medical devices with a same or similar classification in a foreign jurisdiction or any devices intended for implantation in the human body. Should Buyer purchase or use ON Semiconductor products for any such unintended or unauthorized application, Buyer shall indemnify and hold ON Semiconductor and its officers, employees, subsidiaries, affiliates, and distributors harmless against all claims, costs, damages, and expenses, and reasonable attorney fees arising out of, directly or indirectly, any claim of personal injury or death associated with such unintended or unauthorized use, even if such claim alleges that ON Semiconductor was negligent regarding the design or manufacture of the part. ON Semiconductor is an Equal Opportunity/Affirmative Action Employer. This literature is subject to all applicable copyright laws and is not for resale in any manner.

FGA20S140P

1400 V、20 A、短路阳极 IGBT

特性

- 高速开关
- 低饱和电压: $V_{CE(sat)} = 1.9\text{ V} @ I_C = 20\text{ A}$
- 高输入阻抗
- 符合 RoHS 标准

应用

- 感应加热、微波炉

概述

飞兆半导体的短路阳极沟道 IGBT 系列采用先进的场截止沟道和短路阳极技术，为软开关应用提供卓越的导通和开关性能。该器件可并联配置，具有极佳的雪崩能力。该器件为感应加热和微波炉而设计。

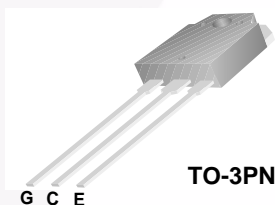

TO-3PN

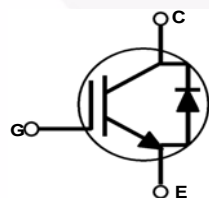

绝对最大额定值 $T_C = 25^\circ\text{C}$ 除非另有说明

符号	说明	额定值	单位
V_{CES}	集电极 - 发射极间电压	1400	V
V_{GES}	栅极 - 发射极间电压	± 25	V
I_C	集电极电流 @ $T_C = 25^\circ\text{C}$	40	A
	集电极电流 @ $T_C = 100^\circ\text{C}$	20	A
$I_{CM(1)}$	集电极脉冲电流	60	A
I_F	二极管正向连续电流 @ $T_C = 25^\circ\text{C}$	40	A
I_F	二极管正向连续电流 @ $T_C = 100^\circ\text{C}$	20	A
P_D	最大功耗 @ $T_C = 25^\circ\text{C}$	272	W
	最大功耗 @ $T_C = 100^\circ\text{C}$	136	W
T_J	工作结温	-55 至 +175	$^\circ\text{C}$
T_{stg}	存储温度范围	-55 至 +175	$^\circ\text{C}$
T_L	用于焊接的最大引脚温度，距离外壳 1/8"，持续 5 秒	300	$^\circ\text{C}$

热性能

符号	参数	典型值	最大值	单位
$R_{\theta JC}(\text{IGBT})$	结点 - 壳体的热阻	--	0.55	$^\circ\text{C}/\text{W}$
$R_{\theta JA}$	结至环境热阻	--	40	$^\circ\text{C}/\text{W}$

注意:

1: 受限于 T_{jmax}

封装标识与订购信息

器件标识	器件	封装	卷尺寸	带宽	数量
FGA20S140P	FGA20S140P	TO-3PN	-	-	30

IGBT 的电气特性 $T_C=25^\circ\text{C}$ 除非另有说明

符号	参数	测试条件	最小值	典型值	最大值	单位
关断特性						
I_{CES}	集电极切断电流	$V_{CE}=1400, V_{GE}=0\text{ V}$	-	-	1	mA
I_{GES}	G-E 漏电流	$V_{GE}=V_{GES}, V_{CE}=0\text{ V}$	-	-	± 500	nA
导通特性						
$V_{GE(th)}$	G-E 阈值电压	$I_C=20\text{ mA}, V_{CE}=V_{GE}$	4.5	6.0	7.5	V
$V_{CE(sat)}$	集电极 - 发射极间饱和电压	$I_C=20\text{ A}, V_{GE}=15\text{ V}$ $T_C=25^\circ\text{C}$	-	1.9	2.4	V
		$I_C=20\text{ A}, V_{GE}=15\text{ V},$ $T_C=125^\circ\text{C}$	-	2.1	-	V
		$I_C=20\text{ A}, V_{GE}=15\text{ V},$ $T_C=175^\circ\text{C}$	-	2.2	-	V
V_{FM}	二极管正向电压	$I_F=20\text{ A}, T_C=25^\circ\text{C}$	-	1.7	2.4	V
		$I_F=20\text{ A}, T_C=175^\circ\text{C}$	-	2.1	-	V
动态特性						
C_{ies}	输入电容	$V_{CE}=30\text{ V}, V_{GE}=0\text{ V},$ $f=1\text{ MHz}$	-	1686	-	pF
C_{oes}	输出电容		-	45	-	pF
C_{res}	反向传输电容		-	32	-	pF
开关特性						
$t_{d(on)}$	导通延迟时间	$V_{CC}=600\text{ V}, I_C=20\text{ A},$ $R_G=10\ \Omega, V_{GE}=15\text{ V},$ 阻性负载, $T_C=25^\circ\text{C}$	-	20	-	ns
t_r	上升时间		-	245	-	ns
$t_{d(off)}$	关断延迟时间		-	400	-	ns
t_f	下降时间		-	130	-	ns
E_{on}	导通开关损耗		-	0.76	-	mJ
E_{off}	关断开关损耗		-	0.56	-	mJ
E_{ts}	总开关损耗	-	1.32	-	mJ	
$t_{d(on)}$	导通延迟时间	$V_{CC}=600\text{ V}, I_C=20\text{ A},$ $R_G=10\ \Omega, V_{GE}=15\text{ V},$ 阻性负载, $T_C=175^\circ\text{C}$	-	21	-	ns
t_r	上升时间		-	301	-	ns
$t_{d(off)}$	关断延迟时间		-	420	-	ns
t_f	下降时间		-	356	-	ns
E_{on}	导通开关损耗		-	0.95	-	mJ
E_{off}	关断开关损耗		-	1.39	-	mJ
E_{ts}	总开关损耗	-	2.34	-	mJ	
Q_g	总栅极电荷	$V_{CE}=600\text{ V}, I_C=20\text{ A},$ $V_{GE}=15\text{ V}$	-	203.5	-	nC
Q_{ge}	栅极 - 发射极间电荷		-	10.8	-	nC
Q_{gc}	栅极 - 发射极间电荷		-	84.6	-	nC

典型性能特征

图 1. 典型输出特性



图 2. 典型输出特性



图 3. 典型饱和电压特性

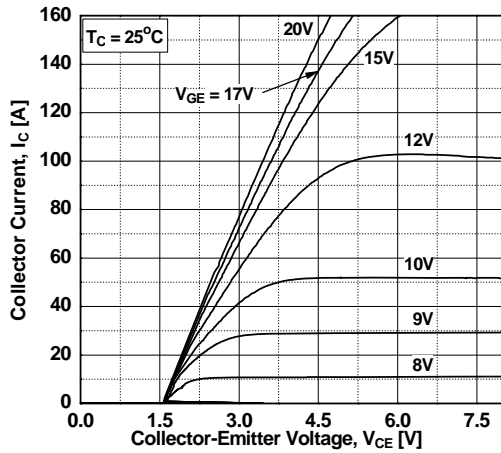

图 4. 传输特性

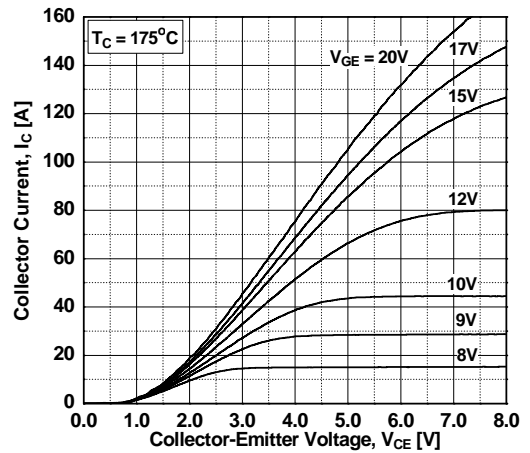

图 5. 饱和电压与外壳的关系

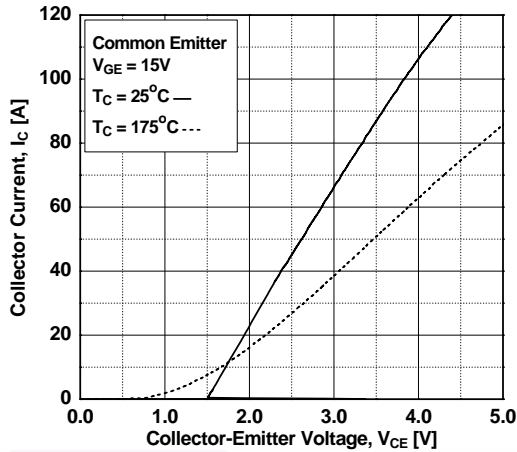

图 6. 饱和电压与 Vge 的关系

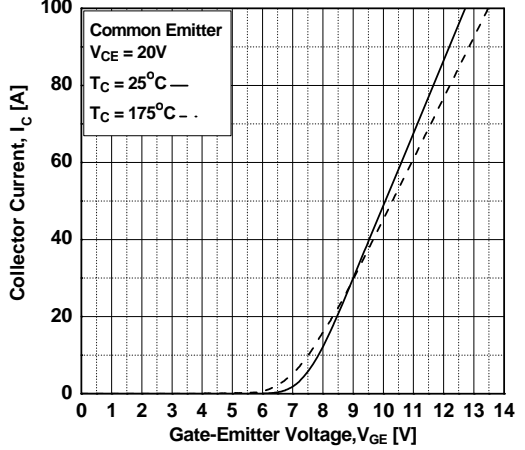

典型性能特征

图 7. 饱和电压与 V_{GE} 的关系

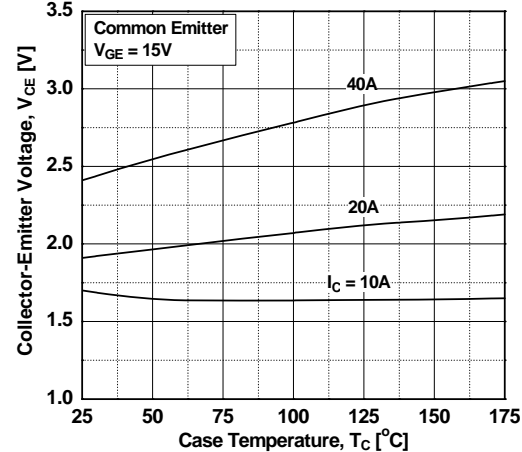
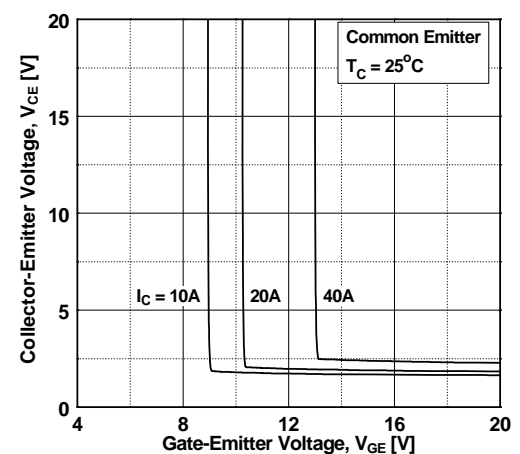

图 8. 电容特性



图 9. 栅极电荷特性

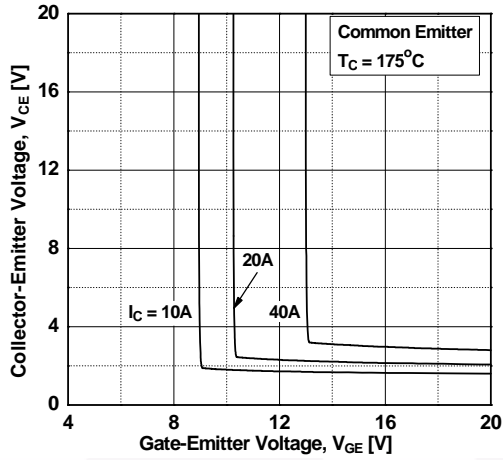

图 10. SOA 特性

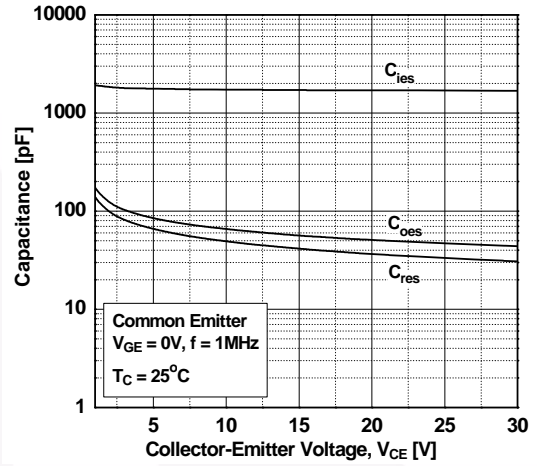

图 11. 导通特性与栅极电阻的关系

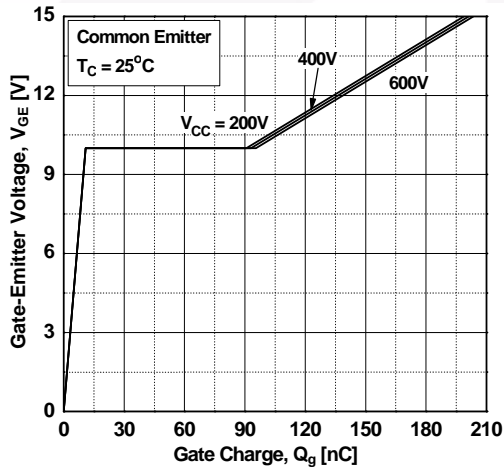

图 12. 关断特性与栅极电阻的关系

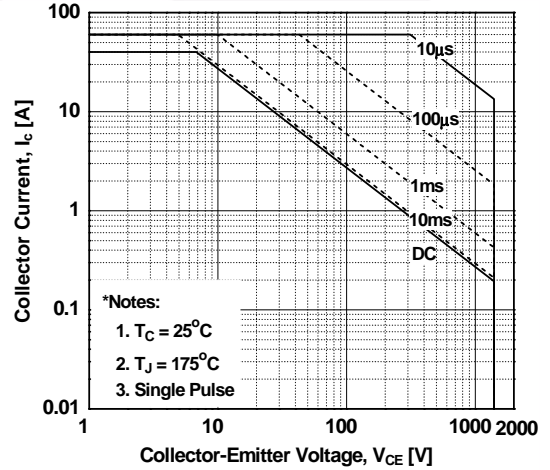

典型性能特征

图 13. 导通特性与集电极电流的关系

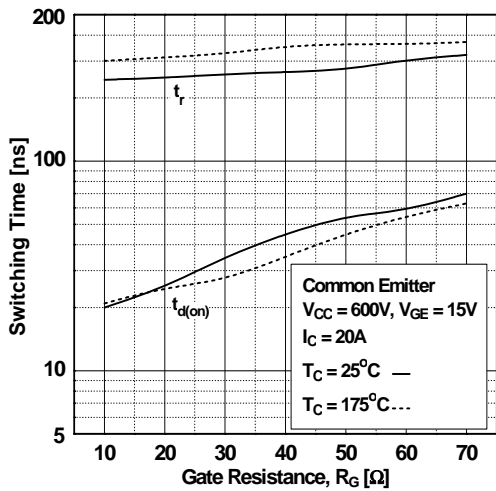
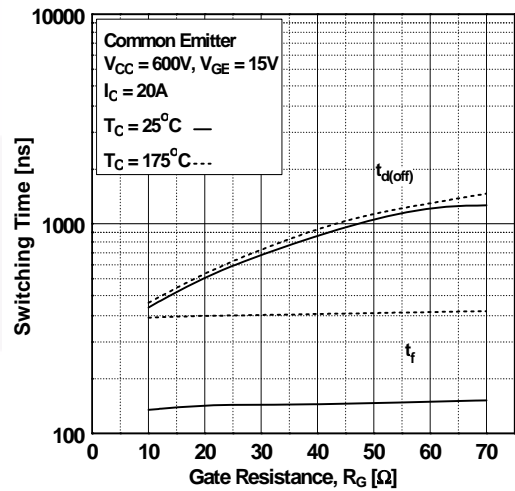

图 14. 关断特性与集电极电流的关系



图 15. 开关损耗与栅极电阻的关系

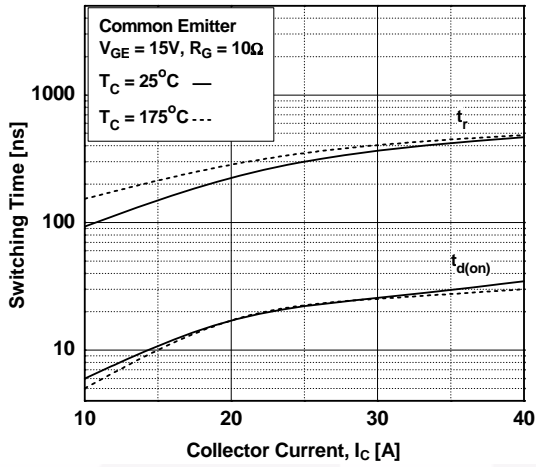

图 16. 开关损耗与栅极电阻的关系

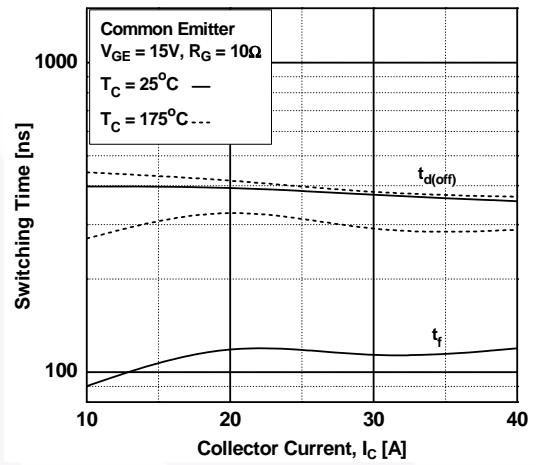

图 17. 关断开关 SOA 特性

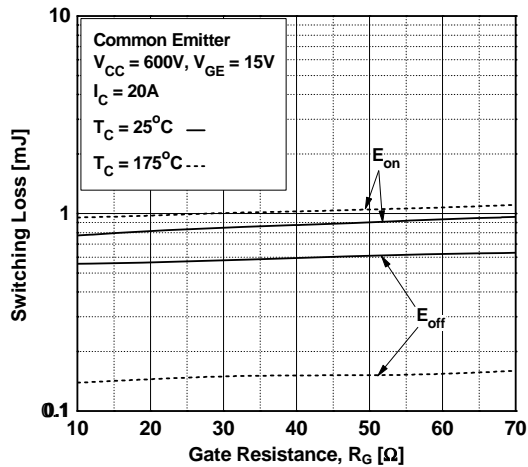

图 18. 正向特性

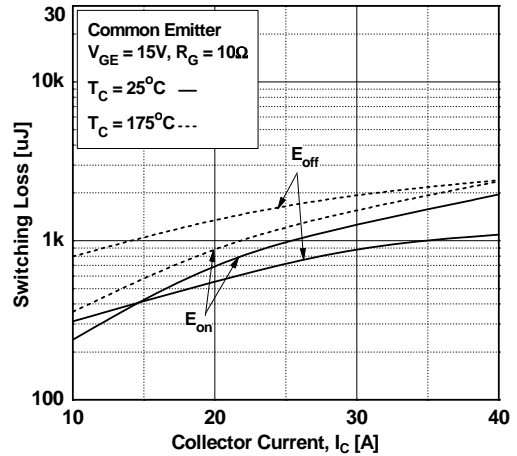

图 19. IGBT 的瞬态热阻抗

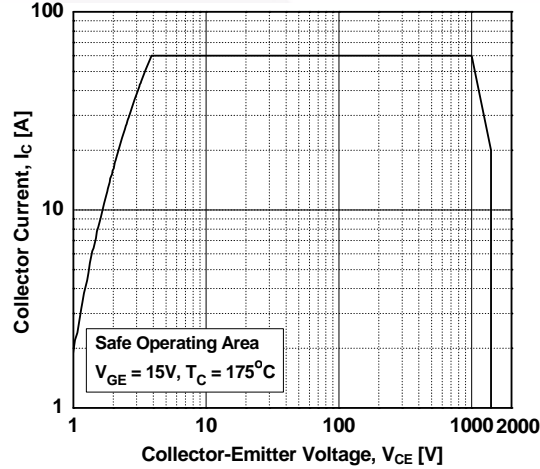

机械尺寸

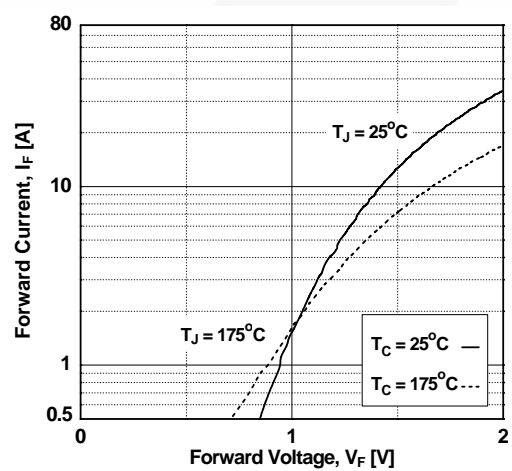
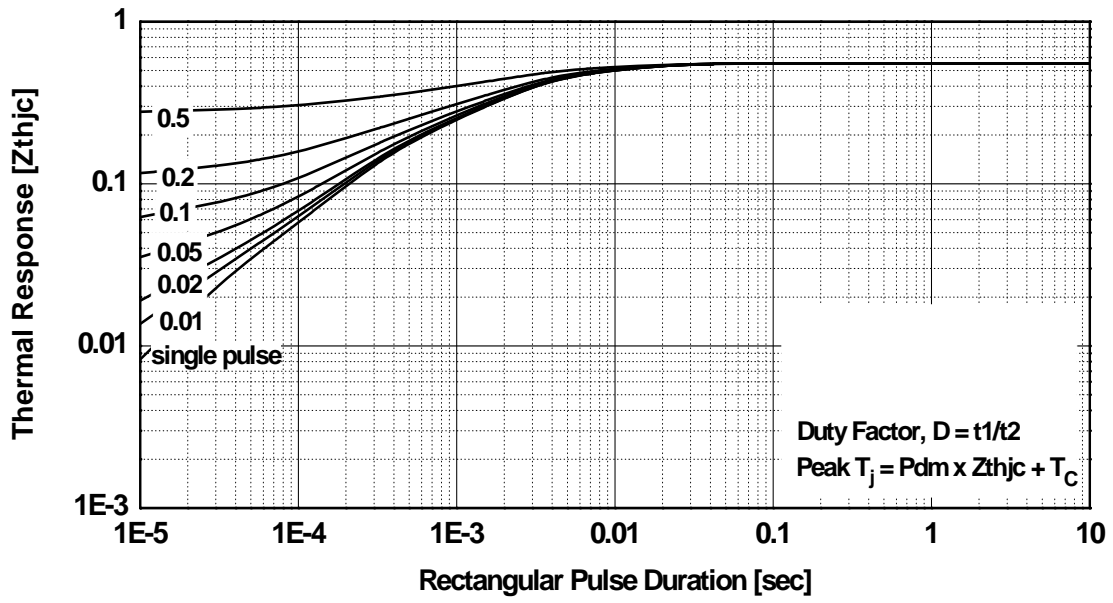
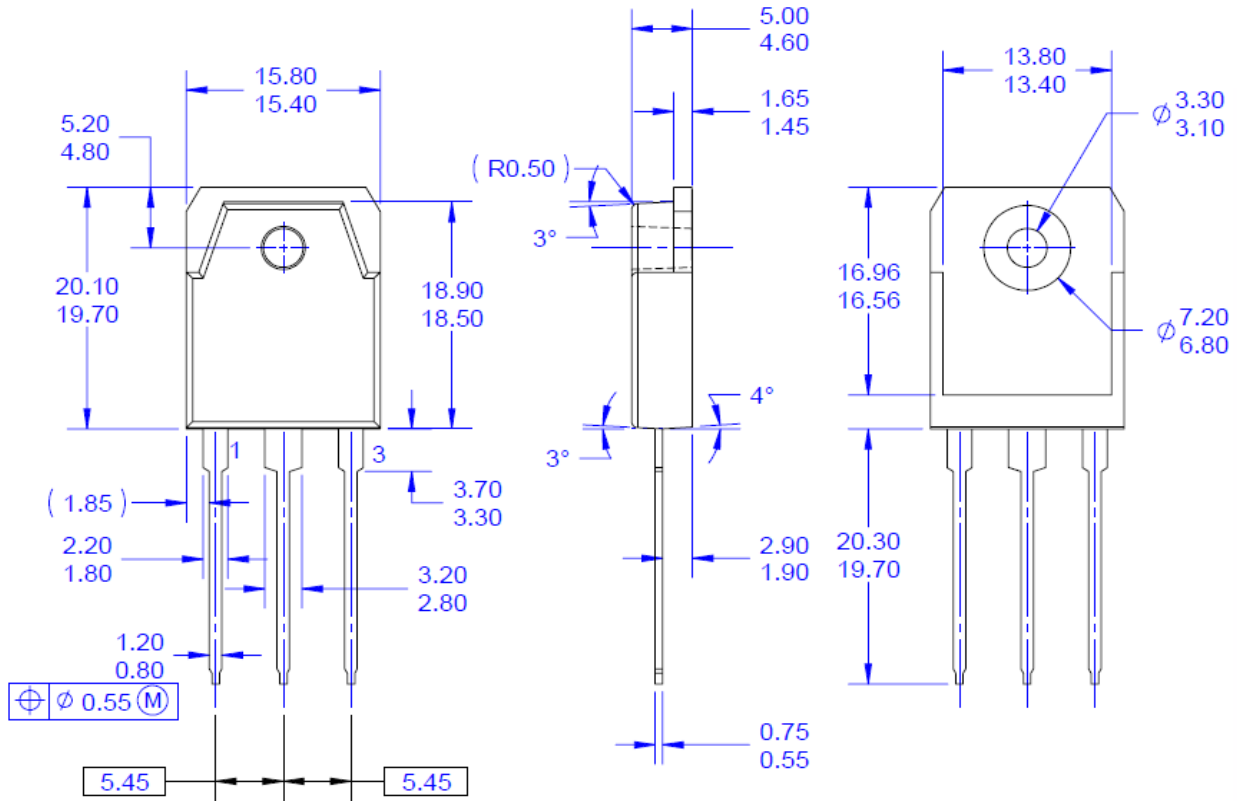

NOTES: UNLESS OTHERWISE SPECIFIED

- A) THIS PACKAGE CONFORMS TO EIAJ SC-65 PACKAGING STANDARD.
- B) ALL DIMENSIONS ARE IN MILLIMETERS.
- C) DIMENSION AND TOLERANCING PER ASME14.5
- D) DIMENSIONS ARE EXCLUSIVE OF BURRS, MOLD FLASH, AND TIE BAR EXTRUSIONS.
- E) THIS PACKAGE IS INTENDED ONLY FOR T03PN.
- F) DRAWING FILE NAME: T03P03AREV4.

图 20. TO-3P 3L - 3LD, T03, PLASTIC, EIAJ SC-65

封装图纸作为一项服务，提供给考虑飞兆半导体元件的客户。具体参数可能会有变化，且不会做出相应通知。请注意图纸上的版本和 / 或日期，并联系飞兆半导体代表核实或获得最新版本。封装规格并不扩大飞兆公司全球范围内的条款与条件，尤其是其中涉及飞兆公司产品保修的部分。

随时访问飞兆半导体在线封装网页，可以获取最新的封装图纸：

http://www.fairchildsemi.com/package/packageDetails.html?id=PN_TT3P0-003

尺寸单位为毫米

ON Semiconductor and  are trademarks of Semiconductor Components Industries, LLC dba ON Semiconductor or its subsidiaries in the United States and/or other countries. ON Semiconductor owns the rights to a number of patents, trademarks, copyrights, trade secrets, and other intellectual property. A listing of ON Semiconductor's product/patent coverage may be accessed at www.onsemi.com/site/pdf/Patent-Marking.pdf. ON Semiconductor reserves the right to make changes without further notice to any products herein. ON Semiconductor makes no warranty, representation or guarantee regarding the suitability of its products for any particular purpose, nor does ON Semiconductor assume any liability arising out of the application or use of any product or circuit, and specifically disclaims any and all liability, including without limitation special, consequential or incidental damages. Buyer is responsible for its products and applications using ON Semiconductor products, including compliance with all laws, regulations and safety requirements or standards, regardless of any support or applications information provided by ON Semiconductor. "Typical" parameters which may be provided in ON Semiconductor data sheets and/or specifications can and do vary in different applications and actual performance may vary over time. All operating parameters, including "Typicals" must be validated for each customer application by customer's technical experts. ON Semiconductor does not convey any license under its patent rights nor the rights of others. ON Semiconductor products are not designed, intended, or authorized for use as a critical component in life support systems or any FDA Class 3 medical devices or medical devices with a same or similar classification in a foreign jurisdiction or any devices intended for implantation in the human body. Should Buyer purchase or use ON Semiconductor products for any such unintended or unauthorized application, Buyer shall indemnify and hold ON Semiconductor and its officers, employees, subsidiaries, affiliates, and distributors harmless against all claims, costs, damages, and expenses, and reasonable attorney fees arising out of, directly or indirectly, any claim of personal injury or death associated with such unintended or unauthorized use, even if such claim alleges that ON Semiconductor was negligent regarding the design or manufacture of the part. ON Semiconductor is an Equal Opportunity/Affirmative Action Employer. This literature is subject to all applicable copyright laws and is not for resale in any manner.

PUBLICATION ORDERING INFORMATION

LITERATURE FULFILLMENT:

Literature Distribution Center for ON Semiconductor
19521 E. 32nd Pkwy, Aurora, Colorado 80011 USA
Phone: 303-675-2175 or 800-344-3860 Toll Free USA/Canada
Fax: 303-675-2176 or 800-344-3867 Toll Free USA/Canada
Email: orderlit@onsemi.com

N. American Technical Support: 800-282-9855 Toll Free
USA/Canada
Europe, Middle East and Africa Technical Support:
Phone: 421 33 790 2910
Japan Customer Focus Center
Phone: 81-3-5817-1050

ON Semiconductor Website: www.onsemi.com
Order Literature: <http://www.onsemi.com/orderlit>
For additional information, please contact your local
Sales Representative