



Is Now Part of



**ON Semiconductor®**

To learn more about ON Semiconductor, please visit our website at  
[www.onsemi.com](http://www.onsemi.com)

Please note: As part of the Fairchild Semiconductor integration, some of the Fairchild orderable part numbers will need to change in order to meet ON Semiconductor's system requirements. Since the ON Semiconductor product management systems do not have the ability to manage part nomenclature that utilizes an underscore (\_), the underscore (\_) in the Fairchild part numbers will be changed to a dash (-). This document may contain device numbers with an underscore (\_). Please check the ON Semiconductor website to verify the updated device numbers. The most current and up-to-date ordering information can be found at [www.onsemi.com](http://www.onsemi.com). Please email any questions regarding the system integration to [Fairchild\\_questions@onsemi.com](mailto:Fairchild_questions@onsemi.com).

ON Semiconductor and the ON Semiconductor logo are trademarks of Semiconductor Components Industries, LLC dba ON Semiconductor or its subsidiaries in the United States and/or other countries. ON Semiconductor owns the rights to a number of patents, trademarks, copyrights, trade secrets, and other intellectual property. A listing of ON Semiconductor's product/patent coverage may be accessed at [www.onsemi.com/site/pdf/Patent-Marking.pdf](http://www.onsemi.com/site/pdf/Patent-Marking.pdf). ON Semiconductor reserves the right to make changes without further notice to any products herein. ON Semiconductor makes no warranty, representation or guarantee regarding the suitability of its products for any particular purpose, nor does ON Semiconductor assume any liability arising out of the application or use of any product or circuit, and specifically disclaims any and all liability, including without limitation special, consequential or incidental damages. Buyer is responsible for its products and applications using ON Semiconductor products, including compliance with all laws, regulations and safety requirements or standards, regardless of any support or applications information provided by ON Semiconductor. "Typical" parameters which may be provided in ON Semiconductor data sheets and/or specifications can and do vary in different applications and actual performance may vary over time. All operating parameters, including "Typicals" must be validated for each customer application by customer's technical experts. ON Semiconductor does not convey any license under its patent rights nor the rights of others. ON Semiconductor products are not designed, intended, or authorized for use as a critical component in life support systems or any FDA Class 3 medical devices or medical devices with a same or similar classification in a foreign jurisdiction or any devices intended for implantation in the human body. Should Buyer purchase or use ON Semiconductor products for any such unintended or unauthorized application, Buyer shall indemnify and hold ON Semiconductor and its officers, employees, subsidiaries, affiliates, and distributors harmless against all claims, costs, damages, and expenses, and reasonable attorney fees arising out of, directly or indirectly, any claim of personal injury or death associated with such unintended or unauthorized use, even if such claim alleges that ON Semiconductor was negligent regarding the design or manufacture of the part. ON Semiconductor is an Equal Opportunity/Affirmative Action Employer. This literature is subject to all applicable copyright laws and is not for resale in any manner.



April 2015

# 74LCX157

## Low Voltage Quad 2-Input Multiplexer with 5 V Tolerant Inputs

### Features

- 5 V Tolerant Inputs
- 2.3 V – 3.6 V,  $V_{CC}$  Specifications Provided
- 5.8 ns  $t_{PD}$  max. ( $V_{CC} = 3.3$  V), 10  $\mu$ A  $I_{CC}$  max.
- Power Down High Impedance Inputs and Outputs
- $\pm 24$  mA Output Drive ( $V_{CC} = 3.0$  V)
- Implements Patented Noise/EMI Reduction Circuitry
- Latch-Up Performance Exceeds 500 mA
- ESD Performance:
  - Human Body Model > 2000 V
  - Machine Model > 200 V

### General Description

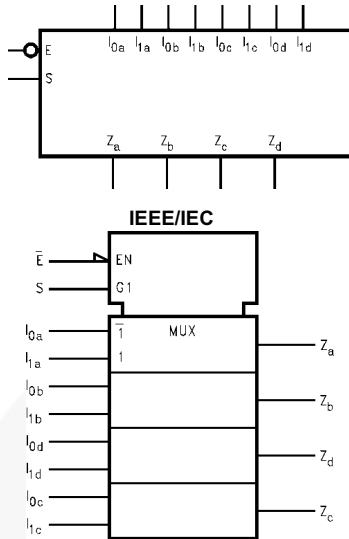
The LCX157 is a high-speed quad 2-input multiplexer. Four bits of data from two sources can be selected using the common Select and Enable inputs. The four outputs present the selected data in the true (noninverted) form. The LCX157 can also be used as a function generator. The 74LCX157 is fabricated with advanced CMOS technology to achieve high speed operation while maintaining CMOS low power dissipation.

### Ordering Information

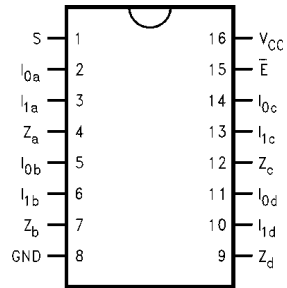
Part Number	Top Mark	Package	Packing Method
74LCX157M	LCX157	SOIC 16L	Rail
74LCX157MX	LCX157	SOIC 16L	Tape and Reel
74LCX157MTC	LCX157	TSSOP 16L	Rail
74LCX157MTCX	LCX157	TSSOP 16L	Tape and Reel

74LCX157 — Low Voltage Quad 2-Input Multiplexer with 5 V Tolerant Inputs

### Logic Symbols



### Connection Diagram



### Pin Descriptions

Pin Names	Description
I <sub>0a</sub> -I <sub>0d</sub>	Source 0 Data Inputs
I <sub>1a</sub> -I <sub>1d</sub>	Source 1 Data Inputs
$\bar{E}$	Enable Input
S	Select Input
Z <sub>a</sub> -Z <sub>d</sub>	Outputs

### Functional Description

The LCX157 is a quad 2-input multiplexer. It selects four bits of data from two sources under the control of a common Select input (S). The Enable input ( $\bar{E}$ ) is active-LOW. When  $\bar{E}$  is HIGH, all of the outputs (Z) are forced LOW regardless of all other inputs. The LCX157 is the logic implementation of a 4-pole, 2-position switch where the position of the switch is determined by the logic levels supplied to the Select input. The logic equations for the outputs are shown below:

$$Z_a = \bar{E} \cdot (I_{1a} \cdot S + I_{0a} \cdot \bar{S})$$

$$Z_b = \bar{E} \cdot (I_{1b} \cdot S + I_{0b} \cdot \bar{S})$$

$$Z_c = \bar{E} \cdot (I_{1c} \cdot S + I_{0c} \cdot \bar{S})$$

$$Z_d = \bar{E} \cdot (I_{1d} \cdot S + I_{0d} \cdot \bar{S})$$

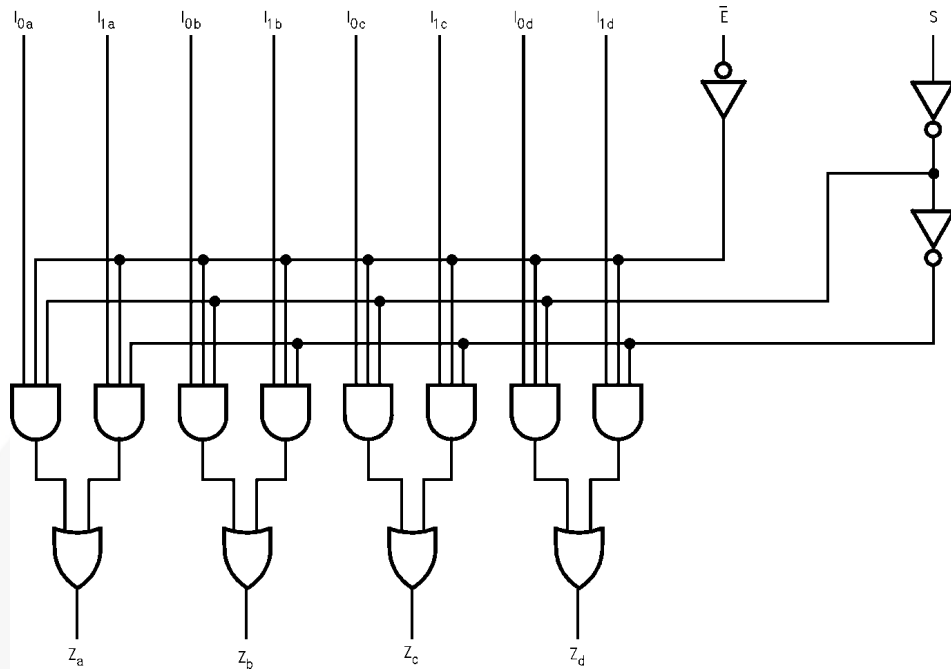
A common use of the LCX157 is the moving of data from two groups of registers to four common output busses. The particular register from which the data comes is determined by the state of the Select input. A less obvious use is as a function generator. The LCX157 can generate any four of the sixteen different functions of two variables with one variable common. This is useful for implementing gating functions.

### Truth Table

Inputs				Outputs
$\bar{E}$	S	I <sub>0</sub>	I <sub>1</sub>	Z
H	X	X	X	L
L	H	X	L	L
L	H	X	H	H
L	L	L	X	L
L	L	H	X	H

H = HIGH Voltage Level  
 L = LOW Voltage Level  
 X = Immaterial

**Logic Diagram<sup>(1)</sup>**



**Note:**

1. Please note that this diagram is provided only for the understanding of logic operations and should not be used to estimate propagation delays.

**Absolute Maximum Ratings<sup>(2)</sup>**

Stresses exceeding the absolute maximum ratings may damage the device. The device may not function or be operable above the recommended operating conditions and stressing the parts to these levels is not recommended. In addition, extended exposure to stresses above the recommended operating conditions may affect device reliability. The absolute maximum ratings are stress ratings only.

Symbol	Parameter	Value	Conditions	Unit
$V_{CC}$	Supply Voltage	-0.5 to +7.0		V
$V_I$	DC Input Voltage	-0.5 to +7.0		V
$V_O$	DC Output Voltage	-0.5 to $V_{CC}+0.5$	Output in HIGH or LOW State <sup>(3)</sup>	V
$I_{IK}$	DC Input Diode Current	-50	$V_I < GND$	mA
$I_{OK}$	DC Output Diode Current	-50	$V_O < GND$	mA
		+50	$V_O > V_{CC}$	
$I_O$	DC Output Source/Sink Current	$\pm 50$		mA
$I_{CC}$	DC Supply Current per Supply Pin	$\pm 100$		mA
$I_{GND}$	DC Ground Current per Ground Pin	$\pm 100$		mA
$T_{STG}$	Storage Temperature	-65 to +150		$^{\circ}C$

**Notes:**

- The Absolute Maximum Ratings are those values beyond which the safety of the device cannot be guaranteed. The device should not be operated at these limits. The parametric values defined in the Electrical Characteristics tables are not guaranteed at the Absolute Maximum Ratings. The "Recommended Operating Conditions" table will define the conditions for actual device operation.
- $I_O$  Absolute Maximum Rating must be observed.

**Recommended Operating Conditions<sup>(4)</sup>**

The Recommended Operating Conditions table defines the conditions for actual device operation. Recommended operating conditions are specified to ensure optimal performance to the datasheet specifications. Fairchild does not recommend exceeding them or designing to absolute maximum ratings.

Symbol	Parameter		Min.	Max.	Unit
$V_{CC}$	Supply Voltage	Operating	2.0	3.6	V
$V_{IN}$	Input Voltage		0	5.5	V
$V_{OUT}$	Output Voltage	HIGH or LOW State	0	$V_{CC}$	V
$I_{OH}/I_{OL}$	Output Current	$V_{CC} = 3.0\text{ V} - 3.6\text{ V}$		$\pm 24$	mA
		$V_{CC} = 2.7\text{ V} - 3.0\text{ V}$		$\pm 12$	
		$V_{CC} = 2.3\text{ V} - 2.7\text{ V}$		$\pm 8$	
$T_A$	Free-Air Operating Temperature		-40	85	$^{\circ}\text{C}$
$\Delta t/\Delta V$	Input Edge Rate, $V_{IN} = 0.8\text{ V} - 2.0\text{ V}$ , $V_{CC} = 3.0\text{ V}$		0	10	ns/V

**Note:**

4. Unused inputs must be held HIGH or LOW. They may not float.

**DC Electrical Characteristics**

Symbol	Parameter	Conditions	$V_{CC}$ (V)	$T_A = -40$ to $+85^{\circ}\text{C}$		Unit
				Min.	Max.	
$V_{IH}$	HIGH Level Input Voltage		2.3 - 2.7	1.7		V
			2.7 - 3.6	2.0		
$V_{IL}$	LOW Level Input Voltage		2.3 - 2.7		0.7	V
			2.7 - 3.6		0.8	
$V_{OH}$	HIGH Level Output Voltage	$I_{OH} = -100\ \mu\text{A}$	2.3 - 3.6	$V_{CC} - 0.2$		V
		$I_{OH} = -8\ \text{mA}$	2.3	1.8		
		$I_{OH} = -12\ \text{mA}$	2.7	2.2		
		$I_{OH} = -18\ \text{mA}$	3.0	2.4		
		$I_{OH} = -24\ \text{mA}$	3.0	2.2		
$V_{OL}$	LOW Level Output Voltage	$I_{OL} = 100\ \mu\text{A}$	2.3 - 3.6		0.2	V
		$I_{OL} = 8\ \text{mA}$	2.3		0.6	
		$I_{OL} = 12\ \text{mA}$	2.7		0.4	
		$I_{OL} = 16\ \text{mA}$	3.0		0.4	
		$I_{OL} = 24\ \text{mA}$	3.0		0.55	
$I_I$	Input Leakage Current	$0 \leq V_I \leq 5.5\text{ V}$	2.3 - 3.6		$\pm 5.0$	$\mu\text{A}$
$I_{OFF}$	Power-Off Leakage Current	$V_I$ or $V_O = 5.5\text{ V}$	0		10	$\mu\text{A}$
$I_{CC}$	Quiescent Supply Current	$V_I = V_{CC}$ or GND	2.3 - 3.6		10	$\mu\text{A}$
		$3.6\text{ V} \leq V_I \leq 5.5\text{ V}$	2.3 - 3.6		$\pm 10$	
$\Delta I_{CC}$	Increase in $I_{CC}$ per Input	$V_{IH} = V_{CC} - 0.6\text{ V}$	2.3 - 3.6		500	$\mu\text{A}$

## AC Electrical Characteristics

Symbol	Parameter	$T_A = -40 \text{ to } +85^\circ\text{C}, R_L = 500 \Omega$						Unit
		$V_{CC} = 3.3 \text{ V} \pm 0.3 \text{ V}$		$V_{CC} = 2.7 \text{ V}$		$V_{CC} = 2.5 \text{ V} \pm 0.2 \text{ V}$		
		$C_L = 50 \text{ pF}$		$C_L = 50 \text{ pF}$		$C_L = 30 \text{ pF}$		
		Min.	Max.	Min.	Max.	Min.	Max.	
$t_{PHL}$	Propagation Delay	1.5	7.0	1.5	8.0	1.5	8.4	ns
$t_{PLH}$	S $\rightarrow$ $Z_n$	1.5	7.0	1.5	8.0	1.5	8.4	
$t_{PHL}$	Propagation Delay	1.5	7.0	1.5	8.0	1.5	8.4	ns
$t_{PLH}$	$\bar{E} \rightarrow Z_n$	1.5	7.0	1.5	8.0	1.5	8.4	
$t_{PHL}$	Propagation Delay	1.5	5.8	1.5	6.3	1.5	7.0	ns
$t_{PLH}$	$I_n \rightarrow Z_n$	1.5	5.8	1.5	6.3	1.5	7.0	
$t_{OSHL}$	Output to Output Skew <sup>(5)</sup>		1.0					ns
$t_{OSLH}$			1.0					

### Note:

5. Skew is defined as the absolute value of the difference between the actual propagation delay for any two separate outputs of the same device. The specification applies to any outputs switching in the same direction, either HIGH-to-LOW ( $t_{OSHL}$ ) or LOW-to-HIGH ( $t_{OSLH}$ ). Parameter guaranteed by design.

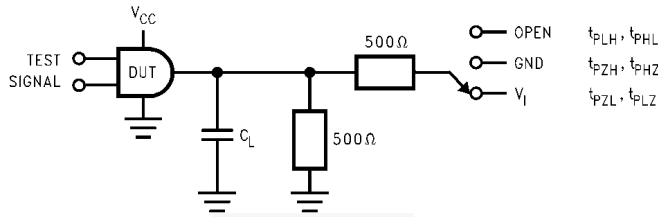
## Dynamic Switching Characteristics

Symbol	Parameter	Conditions	$V_{CC}$ (V)	$T_A = 25^\circ\text{C}$	Unit
				Typical	
$V_{OLP}$	Quiet Output Dynamic Peak $V_{OL}$	$C_L = 50 \text{ pF}, V_{IH} = 3.3 \text{ V}, V_{IL} = 0 \text{ V}$	3.3	0.8	V
		$C_L = 30 \text{ pF}, V_{IH} = 2.5 \text{ V}, V_{IL} = 0 \text{ V}$	2.5	0.6	
$V_{OLV}$	Quiet Output Dynamic Valley $V_{OL}$	$C_L = 50 \text{ pF}, V_{IH} = 3.3 \text{ V}, V_{IL} = 0 \text{ V}$	3.3	-0.8	V
		$C_L = 30 \text{ pF}, V_{IH} = 2.5 \text{ V}, V_{IL} = 0 \text{ V}$	2.5	-0.6	

## Capacitance

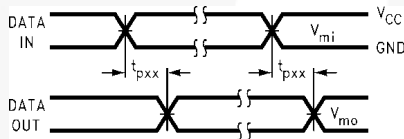
Symbol	Parameter	Conditions	Typical	Unit
$C_{IN}$	Input Capacitance	$V_{CC} = \text{Open}, V_I = 0 \text{ V or } V_{CC}$	7	pF
$C_{OUT}$	Output Capacitance	$V_{CC} = 3.3 \text{ V}, V_I = 0 \text{ V or } V_{CC}$	8	pF
$C_{PD}$	Power Dissipation Capacitance	$V_{CC} = 3.3 \text{ V}, V_I = 0 \text{ V or } V_{CC}, f = 10 \text{ MHz}$	25	pF

**AC Loading and Waveforms** Generic for LCX Family

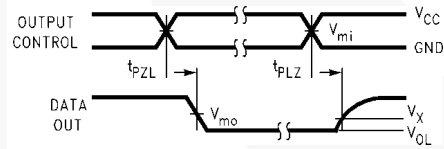


**Figure 1. AC Test Circuit ( $C_L$  includes probe and jig capacitance)**

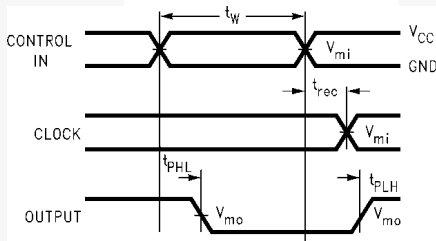
Test	Switch
$t_{PLH}, t_{PHL}$	Open
$t_{PZL}, t_{PLZ}$	6V at $V_{CC} = 3.3 \pm 0.3V$ $V_{CC} \times 2$ at $V_{CC} = 2.5 \pm 0.2V$
$t_{PZH}, t_{PHZ}$	GND



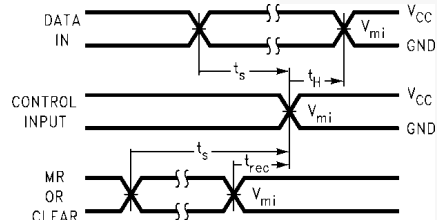
**Waveform for Inverting and Non-Inverting Functions**



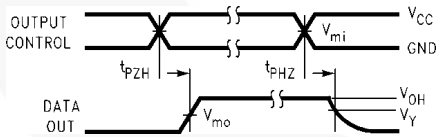
**3-STATE Output Low Enable and Disable Times for Logic**



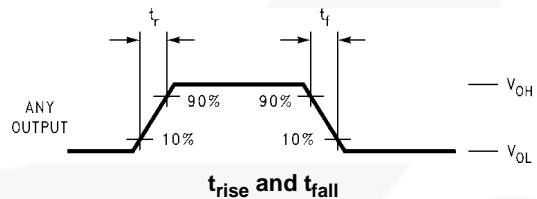
**Propagation Delay, Pulse Width and  $t_{rec}$  Waveforms**



**Setup Time, Hold Time and Recovery Time for Logic**



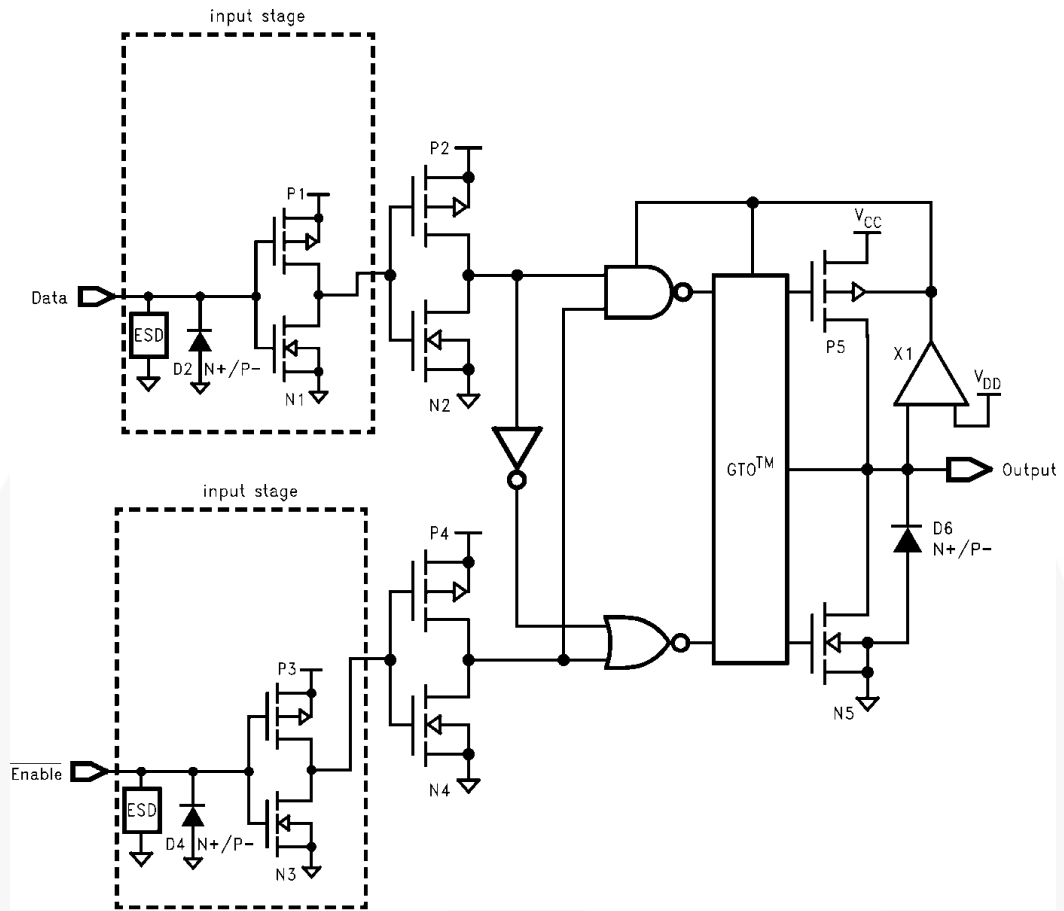
**3-STATE Output High Enable and Disable Times for Logic**



**Figure 2. Waveforms**  
(Input Characteristics;  $f = 1 \text{ MHz}$ ,  $t_r = t_f = 3 \text{ ns}$ )

Symbol	$V_{CC}$		
	$3.3V \pm 0.3V$	$2.7V$	$2.5V \pm 0.2V$
$V_{mi}$	1.5V	1.5V	$V_{CC}/2$
$V_{mo}$	1.5V	1.5V	$V_{CC}/2$
$V_x$	$V_{OL} + 0.3V$	$V_{OL} + 0.3V$	$V_{OL} + 0.15V$
$V_y$	$V_{OH} - 0.3V$	$V_{OH} - 0.3V$	$V_{OH} - 0.15V$

**Schematic Diagram** Generic for LCX Family





Physical Dimensions

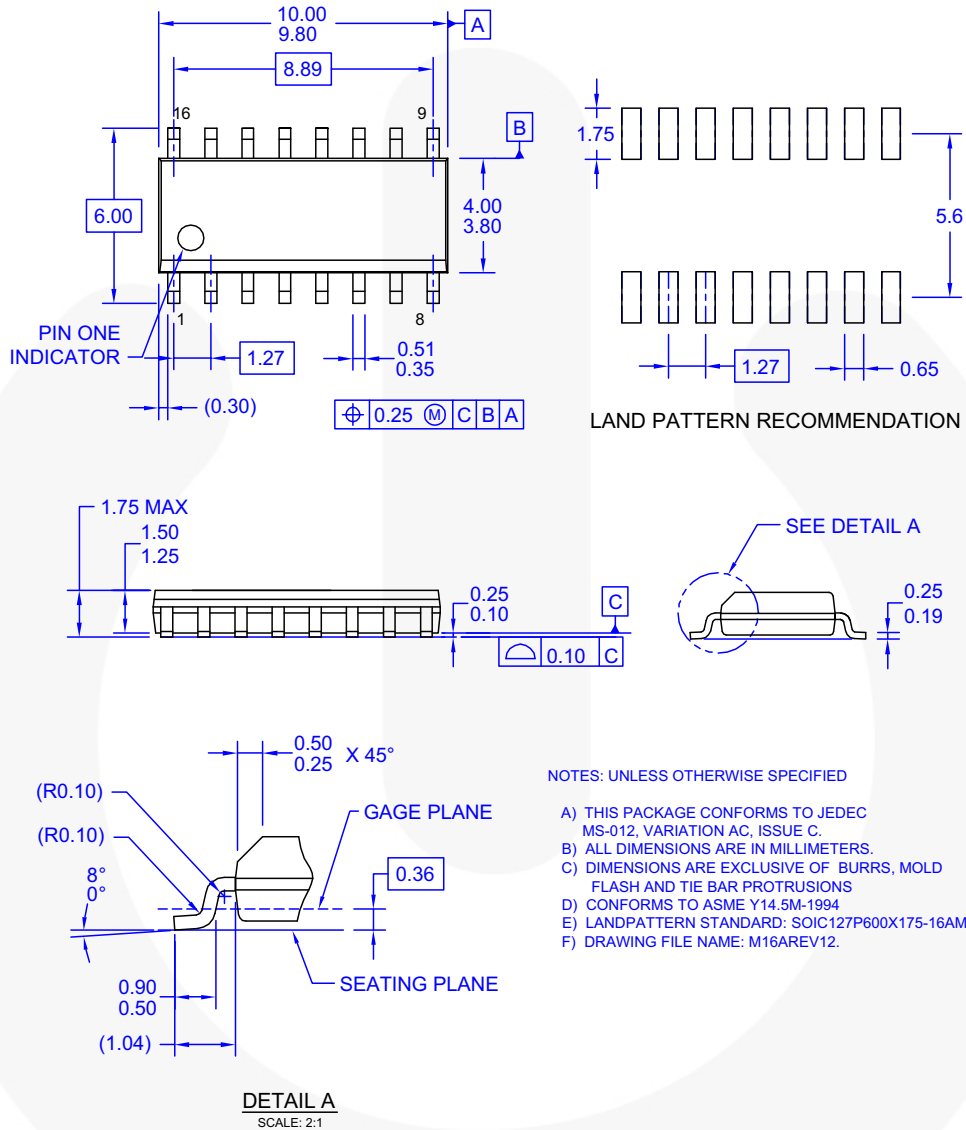
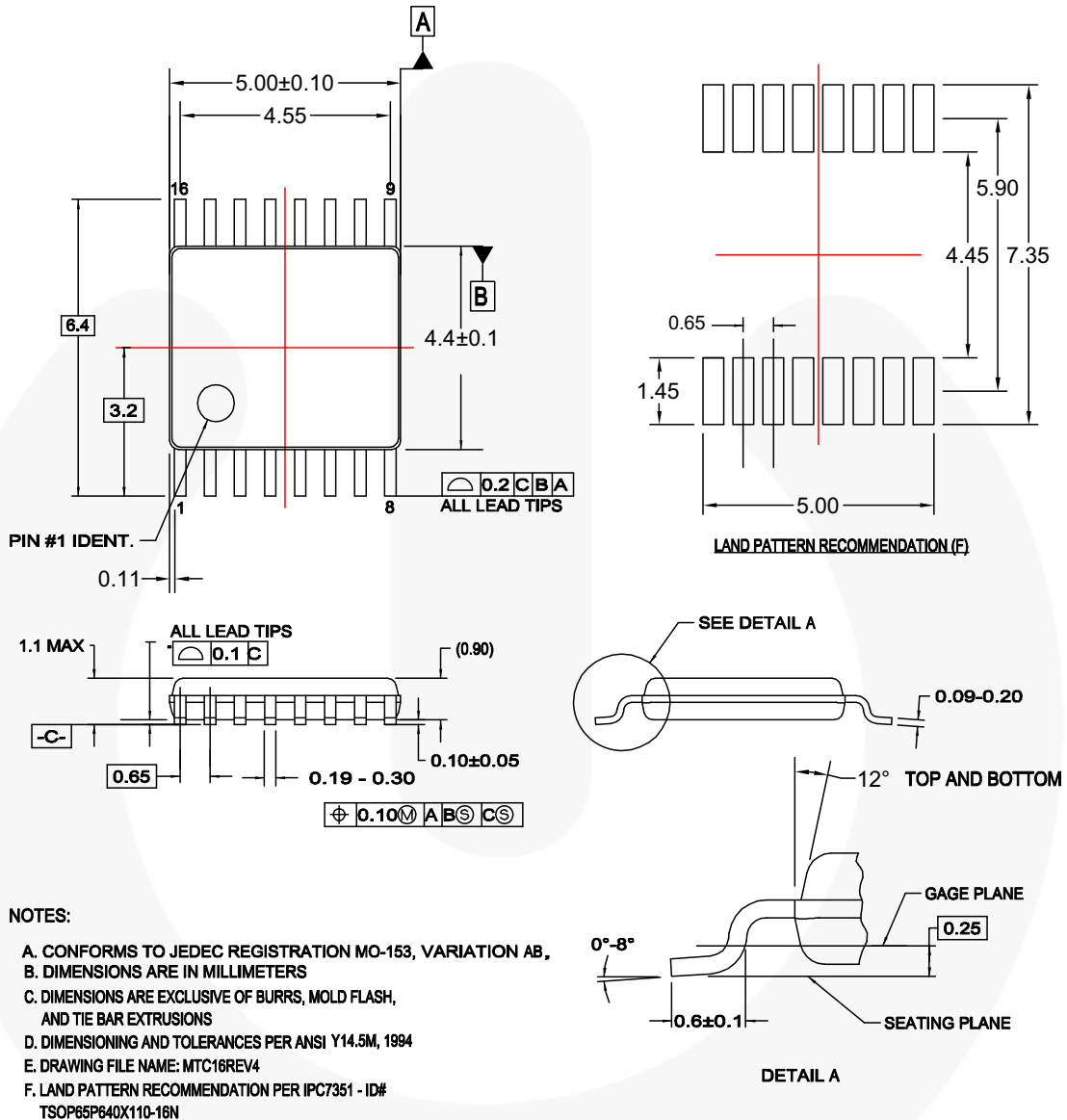


Figure 3. 16-LEAD, SOIC, JEDEC MS-012, 0.150 INCH, NARROW BODY

Physical Dimensions (Continued)








MTC16rev4

Figure 4. 16-LEAD, TSSOP, JEDEC MO-153, 4.4 MM WIDE



**TRADEMARKS**

The following includes registered and unregistered trademarks and service marks, owned by Fairchild Semiconductor and/or its global subsidiaries, and is not intended to be an exhaustive list of all such trademarks.

- |  |  |   |   |
|--|--|---|---|
| AccuPower™   | F-PFS™   | OPTOPLANAR®   |  SYSTEM GENERAL® |
| AttitudeEngine™  | FRFET®   |  ® | TinyBoost®  |
| Awinda®  | Global Power Resource™                         | Power Supply WebDesigner™   | TinyBuck®   |
| AX-CAP®*   | GreenBridge™                                   | PowerTrench®  | TinyCalc™   |
| BitSiC™  | Green FPS™                                     | PowerXS™  | TinyLogic®  |
| Build it Now™  | Green FPS™ e-Series™                           | Programmable Active Droop™  | TINYOPTO™   |
| CorePLUS™  | Gmax™  | QFET®   | TinyPower™  |
| CorePOWER™   | GTO™   | QS™   | TinyPWM™  |
| CROSSVOLT™   | IntelliMAX™                                    | Quiet Series™   | TinyWire™   |
| CTL™   | ISOPLANAR™                                     | RapidConfigure™   | TranSiC™  |
| Current Transfer Logic™  | Making Small Speakers Sound Louder and Better™ |  ™ | TriFault Detect™  |
| DEUXPEED®  | MegaBuck™                                      | Saving our world, 1mW/W/kW at a time™   | TRUECURRENT®*   |
| Dual Cool™   | MICROCOUPLER™                                  | SignalWise™   | μSerDes™  |
| EcoSPARK®  | MicroFET™                                      | SmartMax™   |  SerDes™         |
| EfficientMax™  | MicroPak™                                      | SMART START™  | UHC®  |
| ESBC™  | MicroPak2™                                     | Solutions for Your Success™   | Ultra FRFET™  |
|  Fairchild® | MillerDrive™                                   | SPM®  | UniFET™   |
| Fairchild Semiconductor®   | MotionMax™                                     | STEALTH™  | VCX™  |
| FACT Quiet Series™   | MotionGrid®                                    | SuperFET®   | VisualMax™  |
| FACT®  | MTi®   | SuperSOT™-3   | VoltagePlus™  |
| FAST®  | MTx®   | SuperSOT™-6   | XS™   |
| FastvCore™   | MVN®   | SuperSOT™-8   | Xsens™  |
| FETBench™  | mWSaver®                                       | SupreMOS®   | 仙童™   |
| FPS™   | OptoHiT™                                       | SyncFET™  |   |
|  | OPTOLOGIC®                                     | Sync-Lock™  |   |

\* Trademarks of System General Corporation, used under license by Fairchild Semiconductor.

**DISCLAIMER**

FAIRCHILD SEMICONDUCTOR RESERVES THE RIGHT TO MAKE CHANGES WITHOUT FURTHER NOTICE TO ANY PRODUCTS HEREIN TO IMPROVE RELIABILITY, FUNCTION, OR DESIGN. TO OBTAIN THE LATEST, MOST UP-TO-DATE DATASHEET AND PRODUCT INFORMATION, VISIT OUR WEBSITE AT <http://www.fairchildsemi.com>. FAIRCHILD DOES NOT ASSUME ANY LIABILITY ARISING OUT OF THE APPLICATION OR USE OF ANY PRODUCT OR CIRCUIT DESCRIBED HEREIN; NEITHER DOES IT CONVEY ANY LICENSE UNDER ITS PATENT RIGHTS, NOR THE RIGHTS OF OTHERS. THESE SPECIFICATIONS DO NOT EXPAND THE TERMS OF FAIRCHILD'S WORLDWIDE TERMS AND CONDITIONS, SPECIFICALLY THE WARRANTY THEREIN, WHICH COVERS THESE PRODUCTS.

**LIFE SUPPORT POLICY**

FAIRCHILD'S PRODUCTS ARE NOT AUTHORIZED FOR USE AS CRITICAL COMPONENTS IN LIFE SUPPORT DEVICES OR SYSTEMS WITHOUT THE EXPRESS WRITTEN APPROVAL OF FAIRCHILD SEMICONDUCTOR CORPORATION.

As used herein:

1. Life support devices or systems are devices or systems which, (a) are intended for surgical implant into the body or (b) support or sustain life, and (c) whose failure to perform when properly used in accordance with instructions for use provided in the labeling, can be reasonably expected to result in a significant injury of the user.
2. A critical component in any component of a life support, device, or system whose failure to perform can be reasonably expected to cause the failure of the life support device or system, or to affect its safety or effectiveness.

**ANTI-COUNTERFEITING POLICY**

Fairchild Semiconductor Corporation's Anti-Counterfeiting Policy. Fairchild's Anti-Counterfeiting Policy is also stated on our external website, [www.fairchildsemi.com](http://www.fairchildsemi.com), under Sales Support.

Counterfeiting of semiconductor parts is a growing problem in the industry. All manufacturers of semiconductor products are experiencing counterfeiting of their parts. Customers who inadvertently purchase counterfeit parts experience many problems such as loss of brand reputation, substandard performance, failed applications, and increased cost of production and manufacturing delays. Fairchild is taking strong measures to protect ourselves and our customers from the proliferation of counterfeit parts. Fairchild strongly encourages customers to purchase Fairchild parts either directly from Fairchild or from Authorized Fairchild Distributors who are listed by country on our web page cited above. Products customers buy either from Fairchild directly or from Authorized Fairchild Distributors are genuine parts, have full traceability, meet Fairchild's quality standards for handling and storage and provide access to Fairchild's full range of up-to-date technical and product information. Fairchild and our Authorized Distributors will stand behind all warranties and will appropriately address any warranty issues that may arise. Fairchild will not provide any warranty coverage or other assistance for parts bought from Unauthorized Sources. Fairchild is committed to combat this global problem and encourage our customers to do their part in stopping this practice by buying direct or from authorized distributors.

**PRODUCT STATUS DEFINITIONS**

**Definition of Terms**

Datasheet Identification	Product Status	Definition
Advance Information	Formative / In Design	Datasheet contains the design specifications for product development. Specifications may change in any manner without notice.
Preliminary	First Production	Datasheet contains preliminary data; supplementary data will be published at a later date. Fairchild Semiconductor reserves the right to make changes at any time without notice to improve design.
No Identification Needed	Full Production	Datasheet contains final specifications. Fairchild Semiconductor reserves the right to make changes at any time without notice to improve the design.
Obsolete	Not In Production	Datasheet contains specifications on a product that is discontinued by Fairchild Semiconductor. The datasheet is for reference information only.

Rev. 174

ON Semiconductor and  are trademarks of Semiconductor Components Industries, LLC dba ON Semiconductor or its subsidiaries in the United States and/or other countries. ON Semiconductor owns the rights to a number of patents, trademarks, copyrights, trade secrets, and other intellectual property. A listing of ON Semiconductor's product/patent coverage may be accessed at [www.onsemi.com/site/pdf/Patent-Marking.pdf](http://www.onsemi.com/site/pdf/Patent-Marking.pdf). ON Semiconductor reserves the right to make changes without further notice to any products herein. ON Semiconductor makes no warranty, representation or guarantee regarding the suitability of its products for any particular purpose, nor does ON Semiconductor assume any liability arising out of the application or use of any product or circuit, and specifically disclaims any and all liability, including without limitation special, consequential or incidental damages. Buyer is responsible for its products and applications using ON Semiconductor products, including compliance with all laws, regulations and safety requirements or standards, regardless of any support or applications information provided by ON Semiconductor. "Typical" parameters which may be provided in ON Semiconductor data sheets and/or specifications can and do vary in different applications and actual performance may vary over time. All operating parameters, including "Typicals" must be validated for each customer application by customer's technical experts. ON Semiconductor does not convey any license under its patent rights nor the rights of others. ON Semiconductor products are not designed, intended, or authorized for use as a critical component in life support systems or any FDA Class 3 medical devices or medical devices with a same or similar classification in a foreign jurisdiction or any devices intended for implantation in the human body. Should Buyer purchase or use ON Semiconductor products for any such unintended or unauthorized application, Buyer shall indemnify and hold ON Semiconductor and its officers, employees, subsidiaries, affiliates, and distributors harmless against all claims, costs, damages, and expenses, and reasonable attorney fees arising out of, directly or indirectly, any claim of personal injury or death associated with such unintended or unauthorized use, even if such claim alleges that ON Semiconductor was negligent regarding the design or manufacture of the part. ON Semiconductor is an Equal Opportunity/Affirmative Action Employer. This literature is subject to all applicable copyright laws and is not for resale in any manner.

## PUBLICATION ORDERING INFORMATION

### LITERATURE FULFILLMENT:

Literature Distribution Center for ON Semiconductor  
19521 E. 32nd Pkwy, Aurora, Colorado 80011 USA  
**Phone:** 303-675-2175 or 800-344-3860 Toll Free USA/Canada  
**Fax:** 303-675-2176 or 800-344-3867 Toll Free USA/Canada  
**Email:** [orderlit@onsemi.com](mailto:orderlit@onsemi.com)

**N. American Technical Support:** 800-282-9855 Toll Free  
USA/Canada  
**Europe, Middle East and Africa Technical Support:**  
Phone: 421 33 790 2910  
**Japan Customer Focus Center**  
Phone: 81-3-5817-1050

**ON Semiconductor Website:** [www.onsemi.com](http://www.onsemi.com)  
**Order Literature:** <http://www.onsemi.com/orderlit>  
For additional information, please contact your local  
Sales Representative