



Is Now Part of



**ON Semiconductor®**

To learn more about ON Semiconductor, please visit our website at  
[www.onsemi.com](http://www.onsemi.com)

Please note: As part of the Fairchild Semiconductor integration, some of the Fairchild orderable part numbers will need to change in order to meet ON Semiconductor's system requirements. Since the ON Semiconductor product management systems do not have the ability to manage part nomenclature that utilizes an underscore (\_), the underscore (\_) in the Fairchild part numbers will be changed to a dash (-). This document may contain device numbers with an underscore (\_). Please check the ON Semiconductor website to verify the updated device numbers. The most current and up-to-date ordering information can be found at [www.onsemi.com](http://www.onsemi.com). Please email any questions regarding the system integration to [Fairchild\\_questions@onsemi.com](mailto:Fairchild_questions@onsemi.com).

ON Semiconductor and the ON Semiconductor logo are trademarks of Semiconductor Components Industries, LLC dba ON Semiconductor or its subsidiaries in the United States and/or other countries. ON Semiconductor owns the rights to a number of patents, trademarks, copyrights, trade secrets, and other intellectual property. A listing of ON Semiconductor's product/patent coverage may be accessed at [www.onsemi.com/site/pdf/Patent-Marking.pdf](http://www.onsemi.com/site/pdf/Patent-Marking.pdf). ON Semiconductor reserves the right to make changes without further notice to any products herein. ON Semiconductor makes no warranty, representation or guarantee regarding the suitability of its products for any particular purpose, nor does ON Semiconductor assume any liability arising out of the application or use of any product or circuit, and specifically disclaims any and all liability, including without limitation special, consequential or incidental damages. Buyer is responsible for its products and applications using ON Semiconductor products, including compliance with all laws, regulations and safety requirements or standards, regardless of any support or applications information provided by ON Semiconductor. "Typical" parameters which may be provided in ON Semiconductor data sheets and/or specifications can and do vary in different applications and actual performance may vary over time. All operating parameters, including "Typicals" must be validated for each customer application by customer's technical experts. ON Semiconductor does not convey any license under its patent rights nor the rights of others. ON Semiconductor products are not designed, intended, or authorized for use as a critical component in life support systems or any FDA Class 3 medical devices or medical devices with a same or similar classification in a foreign jurisdiction or any devices intended for implantation in the human body. Should Buyer purchase or use ON Semiconductor products for any such unintended or unauthorized application, Buyer shall indemnify and hold ON Semiconductor and its officers, employees, subsidiaries, affiliates, and distributors harmless against all claims, costs, damages, and expenses, and reasonable attorney fees arising out of, directly or indirectly, any claim of personal injury or death associated with such unintended or unauthorized use, even if such claim alleges that ON Semiconductor was negligent regarding the design or manufacture of the part. ON Semiconductor is an Equal Opportunity/Affirmative Action Employer. This literature is subject to all applicable copyright laws and is not for resale in any manner.

## 74LCX16501

### Low Voltage 18-Bit Universal Bus Transceivers with 5V Tolerant Inputs and Outputs

#### General Description

The LCX16501 is an 18-bit universal bus transceiver combining D-type latches and D-type flip-flops to allow data flow in transparent, latched, and clocked modes.

Data flow in each direction is controlled by output-enable (OEAB and OEBA), latch-enable (LEAB and LEBA), and clock (CLKAB and CLKBA) inputs.

The LCX16501 is designed for low voltage (2.5V or 3.3V)  $V_{CC}$  applications with capability of interfacing to a 5V signal environment.

The LCX16501 is fabricated with an advanced CMOS technology to achieve high speed operation while maintaining CMOS low power.

#### Features

- 5V tolerant inputs and outputs
- 2.3V–3.6V  $V_{CC}$  specifications provided
- 6.0 ns  $t_{PD}$  max ( $V_{CC} = 3.3V$ ), 20  $\mu A$   $I_{CC}$  max
- Power down high impedance inputs and outputs
- Supports live insertion/withdrawal (Note 1)
- $\pm 24$  mA Output Drive ( $V_{CC} = 3.0V$ )
- Implements patented noise/EMI reduction circuitry
- Latch-up performance exceeds 500 mA
- ESD performance:
  - Human body model > 2000V
  - Machine model < 200V

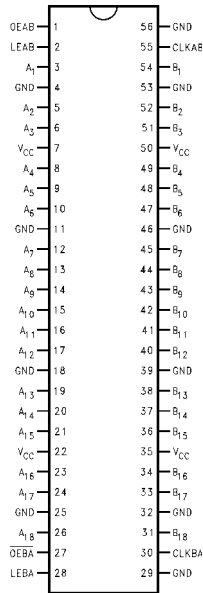
**Note 1:** To ensure the high-impedance state during power up or down,  $\overline{OE}$  should be tied to  $V_{CC}$  and OE tied to GND through a resistor: the minimum value or the resistor is determined by the current-sourcing capability of the driver.

#### Ordering Code:

Order Number	Package Number	Package Description
74LCX16501MEA	MS56A	56-Lead Shrink Small Outline Package (SSOP), JEDEC MO-118, 0.300 Wide
74LCX16501MTD	MTD56	56-Lead Thin Shrink Small Outline Package (TSSOP), JEDEC MO-153, 6.1mm Wide

Devices also available on Tape and Reel. Specify by appending the suffix letter "X" to the ordering code.

### Connection Diagram



### Truth Table

(Note 2)

Inputs				Output
OEAB	LEAB	CLKAB	A <sub>n</sub>	B <sub>n</sub>
L	X	X	X	Z
H	H	X	L	L
H	H	X	H	H
H	L	↑	L	L
H	L	↑	H	H
H	L	H	X	B <sub>0</sub> (Note 3)
H	L	L	X	B <sub>0</sub> (Note 4)

**Note 2:** A-to-B data flow is shown: B-to-A flow is similar but uses OEBA, LEBA, and CLKBA.

**Note 3:** Output level before the indicated steady-state input conditions were established, provided that CLKAB was HIGH before LEAB went LOW.

**Note 4:** Output level before the indicated steady-state input conditions were established.

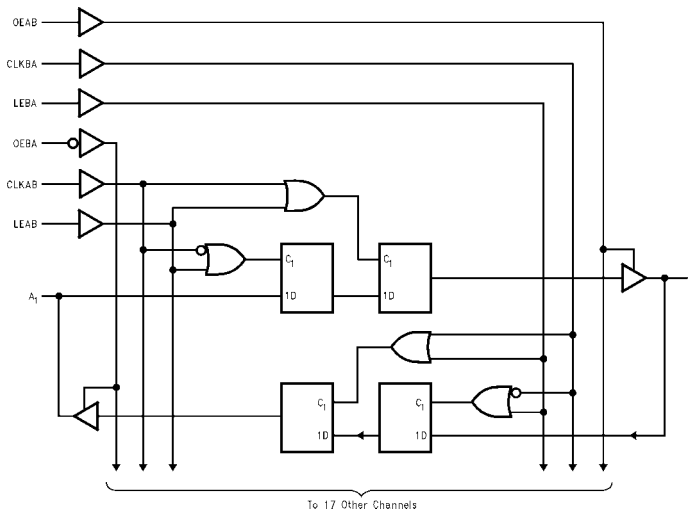
### Functional Description

For A-to-B data flow, the LCX16501 operates in the transparent mode when LEAB is HIGH. When LEAB is LOW, the A data is latched if CLKAB is held at a high or low logic level. If LEAB is LOW, the A bus data is stored in the latch/flip-flop on the LOW-to-HIGH transition of CLKAB. When

OEAB is HIGH, the outputs are active. When OEAB is LOW, the outputs are in the high impedance state.

Data flow for B to A is similar to that of A to B but uses OEBA, LEBA, and CLKBA. The output enables are complementary (OEAB is active HIGH and OEBA is active LOW).

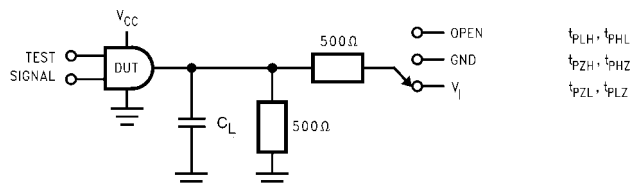
### Logic Diagram



Absolute Maximum Ratings (Note 5)						
Symbol	Parameter	Value	Conditions	Units		
$V_{CC}$	Supply Voltage	-0.5 to +7.0		V		
$V_I$	DC Input Voltage	-0.5 to +7.0		V		
$V_O$	DC Output Voltage	-0.5 to +7.0 -0.5 to $V_{CC} + 0.5$	Output in 3-STATE Output in HIGH or LOW State (Note 6)	V		
$I_{IK}$	DC Input Diode Current	-50	$V_I < GND$	mA		
$I_{OK}$	DC Output Diode Current	-50 +50	$V_O < GND$ $V_O > V_{CC}$	mA		
$I_O$	DC Output Source/Sink Current	$\pm 50$		mA		
$I_{CC}$	DC Supply Current per Supply Pin	$\pm 100$		mA		
$I_{GND}$	DC Ground Current per Ground Pin	$\pm 100$		mA		
$T_{STG}$	Storage Temperature	-65 to +150		°C		
Recommended Operating Conditions (Note 7)						
Symbol	Parameter	Min	Max	Units		
$V_{CC}$	Supply Voltage	Operating	2.0	3.6	V	
		Data Retention	1.5	3.6		
$V_I$	Input Voltage	0	5.5	V		
$V_O$	Output Voltage	HIGH or LOW State	0	$V_{CC}$	V	
		3-STATE	0	5.5		
$I_{OH}/I_{OL}$	Output Current	$V_{CC} = 3.0V - 3.6V$		$\pm 24$	mA	
		$V_{CC} = 2.7V - 3.0V$		$\pm 12$		
		$V_{CC} = 2.3V - 2.7V$		$\pm 8$		
$T_A$	Free-Air Operating Temperature	-40	85	°C		
$\Delta t/\Delta V$	Input Edge Rate, $V_{IN} = 0.8V - 2.0V$ , $V_{CC} = 3.0V$	0	10	ns/V		
<p><b>Note 5:</b> The Absolute Maximum Ratings are those values beyond which the safety of the device cannot be guaranteed. The device should not be operated at these limits. The parametric values defined in the Electrical Characteristics tables are not guaranteed at the Absolute Maximum Ratings. The "Recommended Operating Conditions" table will define the conditions for actual device operation.</p> <p><b>Note 6:</b> <math>I_O</math> Absolute Maximum Rating must be observed.</p> <p><b>Note 7:</b> Unused (inputs or I/Os) must be held HIGH or LOW. They may not float.</p>						
DC Electrical Characteristics						
Symbol	Parameter	Conditions	$V_{CC}$ (V)	$T_A = -40^\circ C$ to $+85^\circ C$		Units
				Min	Max	
$V_{IH}$	HIGH Level Input Voltage		2.3 - 2.7	1.7		V
			2.7 - 3.6	2.0		
$V_{IL}$	LOW Level Input Voltage		2.3 - 2.7		0.7	V
			2.7 - 3.6		0.8	
$V_{OH}$	HIGH Level Output Voltage	$I_{OH} = -100 \mu A$	2.3 - 3.6	$V_{CC} - 0.2$		V
		$I_{OH} = -8 \text{ mA}$	2.3	1.8		
		$I_{OH} = -12 \text{ mA}$	2.7	2.2		
		$I_{OH} = -18 \text{ mA}$	3.0	2.4		
		$I_{OH} = -24 \text{ mA}$	3.0	2.2		
$V_{OL}$	LOW Level Output Voltage	$I_{OL} = 100 \mu A$	2.3 - 3.6		0.2	V
		$I_{OL} = 8 \text{ mA}$	2.3		0.6	
		$I_{OL} = 12 \text{ mA}$	2.7		0.4	
		$I_{OL} = 16 \text{ mA}$	3.0		0.4	
		$I_{OL} = 24 \text{ mA}$	3.0		0.55	
$I_I$	Input Leakage Current	$0 \leq V_I \leq 5.5V$	2.3 - 3.6		$\pm 5.0$	$\mu A$
$I_{OZ}$	3-STATE I/O Leakage	$0 \leq V_O \leq 5.5V$ $V_I = V_{IH}$ or $V_{IL}$	2.3 - 3.6		$\pm 5.0$	$\mu A$
$I_{OFF}$	Power-Off Leakage Current	$V_I$ or $V_O = 5.5V$	0		10	$\mu A$

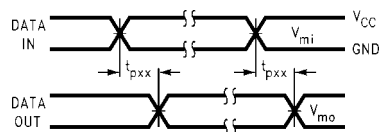
DC Electrical Characteristics (Continued)								
Symbol	Parameter	Conditions	V <sub>CC</sub> (V)	T <sub>A</sub> = -40°C to +85°C		Units		
				Min	Max			
I <sub>CC</sub>	Quiescent Supply Current	V <sub>I</sub> = V <sub>CC</sub> or GND	2.3 – 3.6		20	μA		
		3.6V ≤ V <sub>I</sub> , V <sub>O</sub> ≤ 5.5V (Note 8)	2.3 – 3.6		±20			
ΔI <sub>CC</sub>	Increase in I <sub>CC</sub> per Input	V <sub>IH</sub> = V <sub>CC</sub> - 0.6V	2.3 – 3.6		500	μA		
<b>Note 8:</b> Outputs disabled or 3-STATE only.								
AC Electrical Characteristics								
Symbol	Parameter	T <sub>A</sub> = -40°C to +85°C, R <sub>L</sub> = 500Ω						Units
		V <sub>CC</sub> = 3.3V ± 0.3V		V <sub>CC</sub> = 2.7V		V <sub>CC</sub> = 2.5V ± 0.2V		
		C <sub>L</sub> = 50 pF		C <sub>L</sub> = 50 pF		C <sub>L</sub> = 30 pF		
		Min	Max	Min	Max	Min	Max	
f <sub>MAX</sub>	Maximum Clock Frequency	170					MHz	
t <sub>PHL</sub>	Propagation Delay	1.5	6.0	1.5	7.0	1.5	7.2	ns
t <sub>PLH</sub>	Bus to Bus	1.5	6.0	1.5	7.0	1.5	7.2	
t <sub>PHL</sub>	Propagation Delay	1.5	6.7	1.5	8.0	1.5	8.4	ns
t <sub>PLH</sub>	Clock to Bus	1.5	6.7	1.5	8.0	1.5	8.4	
t <sub>PHL</sub>	Propagation Delay	1.5	7.0	1.5	8.0	1.5	8.4	ns
t <sub>PLH</sub>	LE to Bus	1.5	7.0	1.5	8.0	1.5	8.4	
t <sub>PZL</sub>	Output Enable Time	1.5	7.2	1.5	8.2	1.5	9.4	ns
t <sub>PZH</sub>		1.5	7.2	1.5	8.2	1.5	9.4	
t <sub>PLZ</sub>	Output Disable Time	1.5	7.0	1.5	8.0	1.5	8.4	ns
t <sub>PHZ</sub>		1.5	7.0	1.5	8.0	1.5	8.4	
t <sub>S</sub>	Setup Time	2.5		2.5		3.0		ns
t <sub>H</sub>	Hold Time	1.5		1.5		2.0		ns
t <sub>W</sub>	Pulse Width	3.0		3.0		3.5		ns
t <sub>OSHL</sub>	Output to Output Skew		1.0					ns
t <sub>OSLH</sub>	(Note 9)		1.0					
<b>Note 9:</b> Skew is defined as the absolute value of the difference between the actual propagation delay for any two separate outputs of the same device. The specification applies to any outputs switching in the same direction, either HIGH-to-LOW (t <sub>OSHL</sub> ), or LOW-to-HIGH (t <sub>OSLH</sub> ).								
Dynamic Switching Characteristics								
Symbol	Parameter	Conditions	V <sub>CC</sub> (V)	T <sub>A</sub> = 25°C		Units		
				Typical				
V <sub>OLP</sub>	Quiet Output Dynamic Peak V <sub>OL</sub>	C <sub>L</sub> = 50 pF, V <sub>IH</sub> = 3.3V, V <sub>IL</sub> = 0V	3.3	0.8		V		
		C <sub>L</sub> = 30 pF, V <sub>IH</sub> = 2.5V, V <sub>IL</sub> = 0V	2.5	0.6				
V <sub>OLV</sub>	Quiet Output Dynamic Valley V <sub>OL</sub>	C <sub>L</sub> = 50 pF, V <sub>IH</sub> = 3.3V, V <sub>IL</sub> = 0V	3.3	-0.8		V		
		C <sub>L</sub> = 30 pF, V <sub>IH</sub> = 2.5V, V <sub>IL</sub> = 0V	2.5	-0.6				
Capacitance								
Symbol	Parameter	Conditions	Typical	Units				
C <sub>IN</sub>	Input Capacitance	V <sub>CC</sub> = Open, V <sub>I</sub> = 0V or V <sub>CC</sub>	7	pF				
C <sub>I/O</sub>	Input/Output Capacitance	V <sub>CC</sub> = 3.3V, V <sub>I</sub> = 0V or V <sub>CC</sub>	8	pF				
C <sub>PD</sub>	Power Dissipation Capacitance	V <sub>CC</sub> = 3.3V, V <sub>I</sub> = 0V or V <sub>CC</sub> , f = 10 MHz	20	pF				

**AC LOADING and WAVEFORMS** Generic for LCX Family

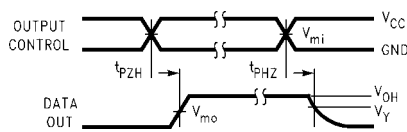


**FIGURE 1. AC Test Circuit ( $C_L$  includes probe and jig capacitance)**

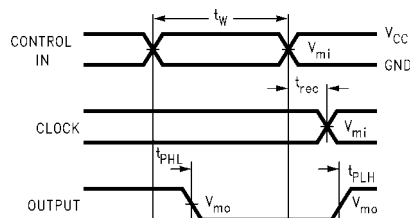
Test	Switch
$t_{PLH}, t_{PHL}$	Open
$t_{PZL}, t_{PLZ}$	6V at $V_{CC} = 3.3 \pm 0.3V$ $V_{CC} \times 2$ at $V_{CC} = 2.5 \pm 0.2V$
$t_{PZH}, t_{PHZ}$	GND



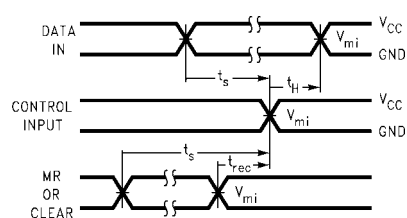
**Waveform for Inverting and Non-Inverting Functions**



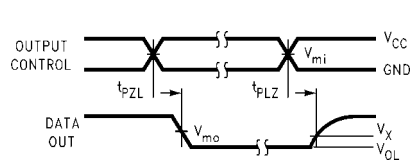
**3-STATE Output High Enable and Disable Times for Logic**



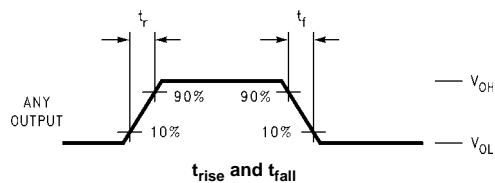
**Propagation Delay, Pulse Width and  $t_{rec}$  Waveforms**



**Setup Time, Hold Time and Recovery Time for Logic**

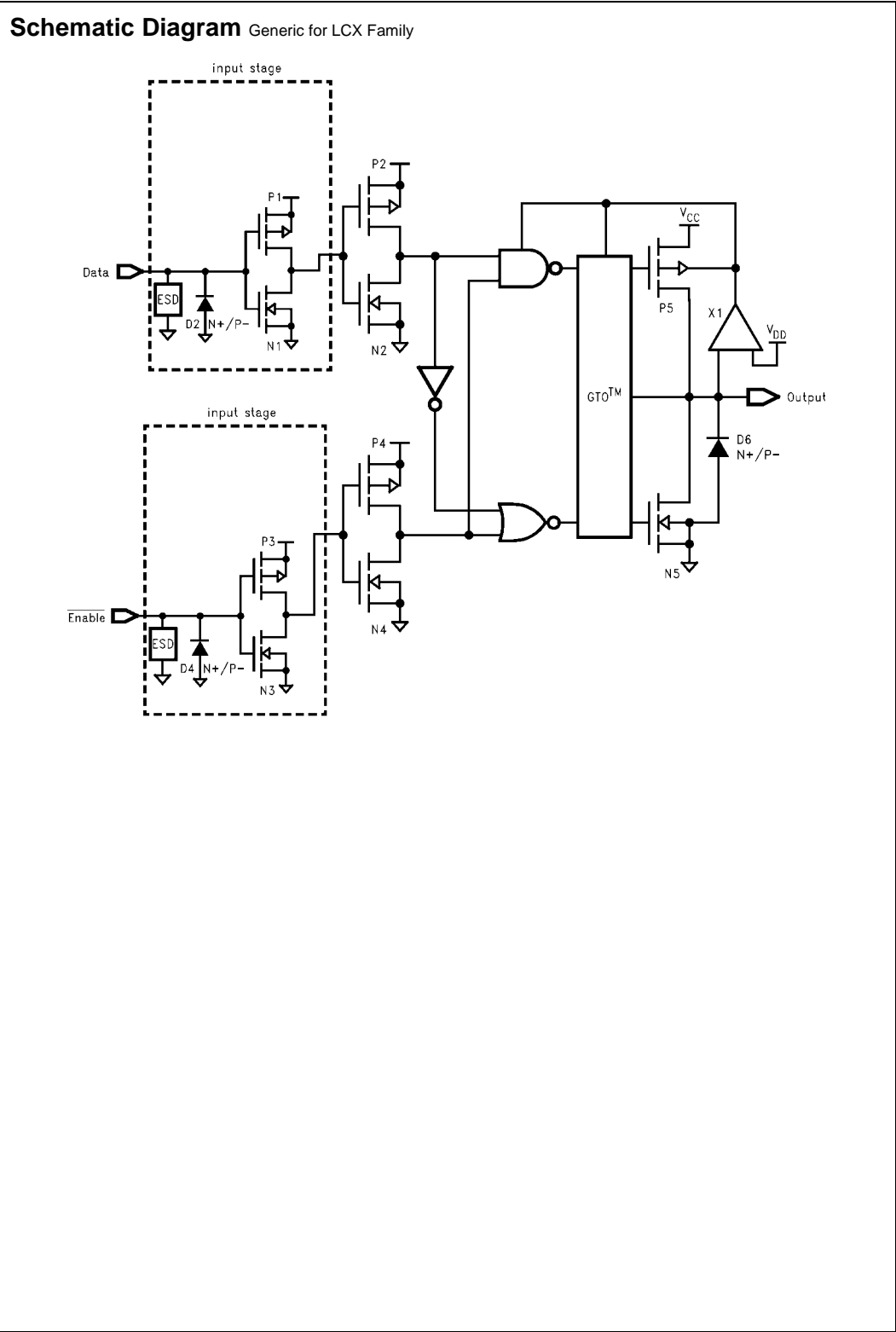


**3-STATE Output Low Enable and Disable Times for Logic**

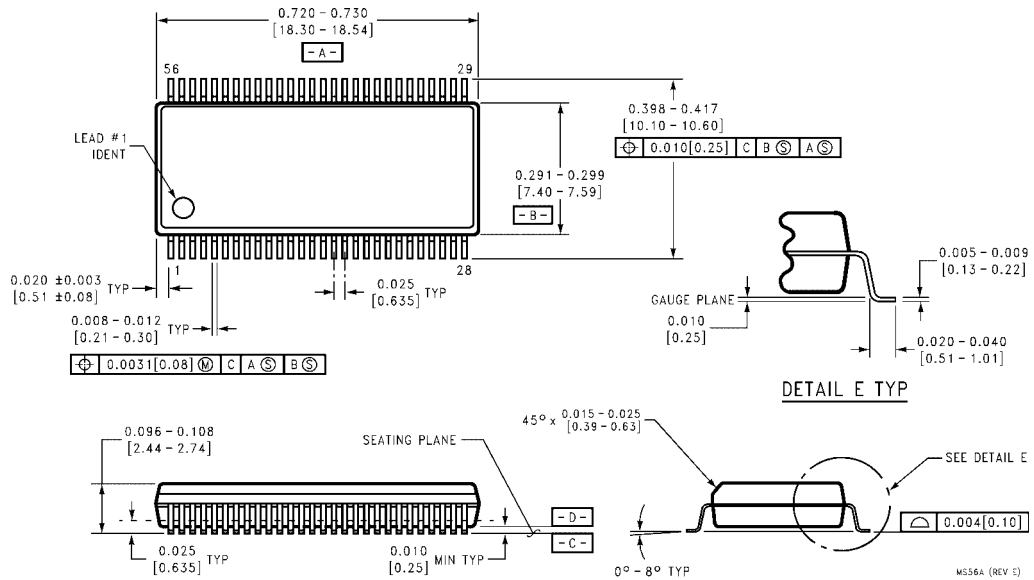


**FIGURE 2. Waveforms**  
(Input Characteristics;  $f = 1MHz, t_r = t_f = 3ns$ )

Symbol	$V_{CC}$		
	$3.3V \pm 0.3V$	$2.7V$	$2.5V \pm 0.2V$
$V_{mi}$	1.5V	1.5V	$V_{CC}/2$
$V_{mo}$	1.5V	1.5V	$V_{CC}/2$
$V_x$	$V_{OL} + 0.3V$	$V_{OL} + 0.3V$	$V_{OL} + 0.15V$
$V_y$	$V_{OH} - 0.3V$	$V_{OH} - 0.3V$	$V_{OH} - 0.15V$



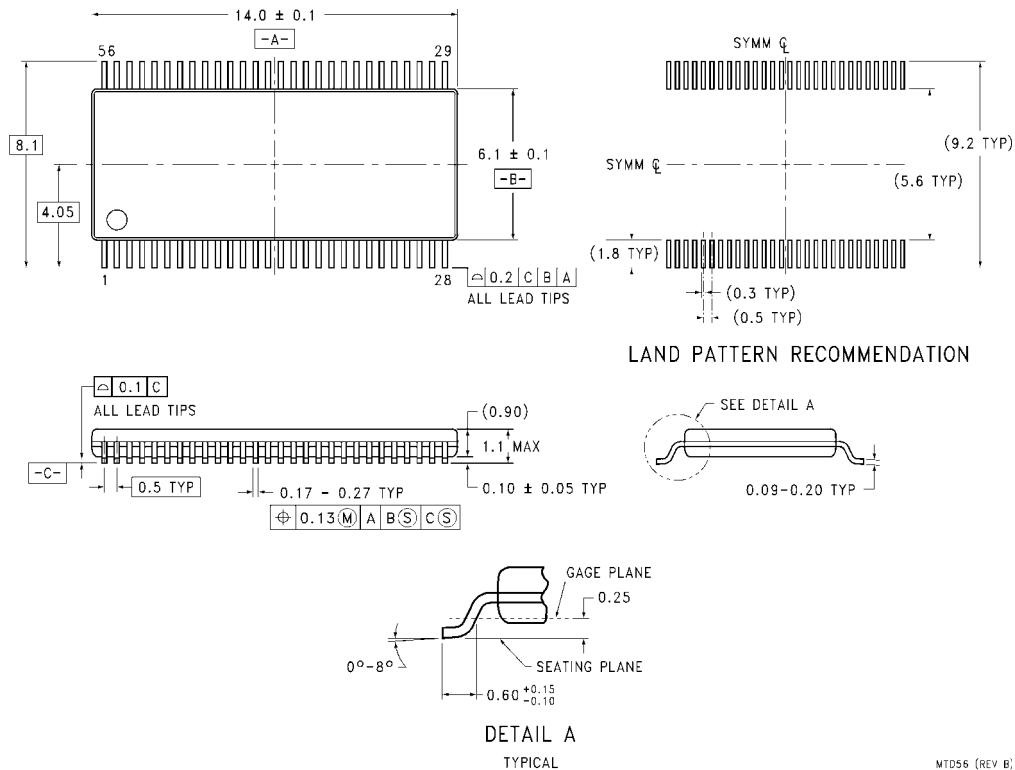
**Physical Dimensions** inches (millimeters) unless otherwise noted



**56-Lead Shrink Small Outline Package (SSOP), JEDEC MO-118, 0.300 Wide  
Package Number MS56A**



**Physical Dimensions** inches (millimeters) unless otherwise noted (Continued)



**56-Lead Thin Shrink Small Outline Package (TSSOP), JEDEC MO-153, 6.1mm Wide Package Number MTD56**

MTD56 (REV B)

Fairchild does not assume any responsibility for use of any circuitry described, no circuit patent licenses are implied and Fairchild reserves the right at any time without notice to change said circuitry and specifications.

**LIFE SUPPORT POLICY**

FAIRCHILD'S PRODUCTS ARE NOT AUTHORIZED FOR USE AS CRITICAL COMPONENTS IN LIFE SUPPORT DEVICES OR SYSTEMS WITHOUT THE EXPRESS WRITTEN APPROVAL OF THE PRESIDENT OF FAIRCHILD SEMICONDUCTOR CORPORATION. As used herein:

1. Life support devices or systems are devices or systems which, (a) are intended for surgical implant into the body, or (b) support or sustain life, and (c) whose failure to perform when properly used in accordance with instructions for use provided in the labeling, can be reasonably expected to result in a significant injury to the user.
2. A critical component in any component of a life support device or system whose failure to perform can be reasonably expected to cause the failure of the life support device or system, or to affect its safety or effectiveness.

[www.fairchildsemi.com](http://www.fairchildsemi.com)

ON Semiconductor and  are trademarks of Semiconductor Components Industries, LLC dba ON Semiconductor or its subsidiaries in the United States and/or other countries. ON Semiconductor owns the rights to a number of patents, trademarks, copyrights, trade secrets, and other intellectual property. A listing of ON Semiconductor's product/patent coverage may be accessed at [www.onsemi.com/site/pdf/Patent-Marking.pdf](http://www.onsemi.com/site/pdf/Patent-Marking.pdf). ON Semiconductor reserves the right to make changes without further notice to any products herein. ON Semiconductor makes no warranty, representation or guarantee regarding the suitability of its products for any particular purpose, nor does ON Semiconductor assume any liability arising out of the application or use of any product or circuit, and specifically disclaims any and all liability, including without limitation special, consequential or incidental damages. Buyer is responsible for its products and applications using ON Semiconductor products, including compliance with all laws, regulations and safety requirements or standards, regardless of any support or applications information provided by ON Semiconductor. "Typical" parameters which may be provided in ON Semiconductor data sheets and/or specifications can and do vary in different applications and actual performance may vary over time. All operating parameters, including "Typicals" must be validated for each customer application by customer's technical experts. ON Semiconductor does not convey any license under its patent rights nor the rights of others. ON Semiconductor products are not designed, intended, or authorized for use as a critical component in life support systems or any FDA Class 3 medical devices or medical devices with a same or similar classification in a foreign jurisdiction or any devices intended for implantation in the human body. Should Buyer purchase or use ON Semiconductor products for any such unintended or unauthorized application, Buyer shall indemnify and hold ON Semiconductor and its officers, employees, subsidiaries, affiliates, and distributors harmless against all claims, costs, damages, and expenses, and reasonable attorney fees arising out of, directly or indirectly, any claim of personal injury or death associated with such unintended or unauthorized use, even if such claim alleges that ON Semiconductor was negligent regarding the design or manufacture of the part. ON Semiconductor is an Equal Opportunity/Affirmative Action Employer. This literature is subject to all applicable copyright laws and is not for resale in any manner.

## PUBLICATION ORDERING INFORMATION

### LITERATURE FULFILLMENT:

Literature Distribution Center for ON Semiconductor  
19521 E. 32nd Pkwy, Aurora, Colorado 80011 USA  
**Phone:** 303-675-2175 or 800-344-3860 Toll Free USA/Canada  
**Fax:** 303-675-2176 or 800-344-3867 Toll Free USA/Canada  
**Email:** [orderlit@onsemi.com](mailto:orderlit@onsemi.com)

**N. American Technical Support:** 800-282-9855 Toll Free  
USA/Canada  
**Europe, Middle East and Africa Technical Support:**  
Phone: 421 33 790 2910  
**Japan Customer Focus Center**  
Phone: 81-3-5817-1050

**ON Semiconductor Website:** [www.onsemi.com](http://www.onsemi.com)  
**Order Literature:** <http://www.onsemi.com/orderlit>  
For additional information, please contact your local  
Sales Representative