



Is Now Part of



ON Semiconductor®

To learn more about ON Semiconductor, please visit our website at
www.onsemi.com

Please note: As part of the Fairchild Semiconductor integration, some of the Fairchild orderable part numbers will need to change in order to meet ON Semiconductor's system requirements. Since the ON Semiconductor product management systems do not have the ability to manage part nomenclature that utilizes an underscore (_), the underscore (_) in the Fairchild part numbers will be changed to a dash (-). This document may contain device numbers with an underscore (_). Please check the ON Semiconductor website to verify the updated device numbers. The most current and up-to-date ordering information can be found at www.onsemi.com. Please email any questions regarding the system integration to Fairchild_questions@onsemi.com.

ON Semiconductor and the ON Semiconductor logo are trademarks of Semiconductor Components Industries, LLC dba ON Semiconductor or its subsidiaries in the United States and/or other countries. ON Semiconductor owns the rights to a number of patents, trademarks, copyrights, trade secrets, and other intellectual property. A listing of ON Semiconductor's product/patent coverage may be accessed at www.onsemi.com/site/pdf/Patent-Marking.pdf. ON Semiconductor reserves the right to make changes without further notice to any products herein. ON Semiconductor makes no warranty, representation or guarantee regarding the suitability of its products for any particular purpose, nor does ON Semiconductor assume any liability arising out of the application or use of any product or circuit, and specifically disclaims any and all liability, including without limitation special, consequential or incidental damages. Buyer is responsible for its products and applications using ON Semiconductor products, including compliance with all laws, regulations and safety requirements or standards, regardless of any support or applications information provided by ON Semiconductor. "Typical" parameters which may be provided in ON Semiconductor data sheets and/or specifications can and do vary in different applications and actual performance may vary over time. All operating parameters, including "Typicals" must be validated for each customer application by customer's technical experts. ON Semiconductor does not convey any license under its patent rights nor the rights of others. ON Semiconductor products are not designed, intended, or authorized for use as a critical component in life support systems or any FDA Class 3 medical devices or medical devices with a same or similar classification in a foreign jurisdiction or any devices intended for implantation in the human body. Should Buyer purchase or use ON Semiconductor products for any such unintended or unauthorized application, Buyer shall indemnify and hold ON Semiconductor and its officers, employees, subsidiaries, affiliates, and distributors harmless against all claims, costs, damages, and expenses, and reasonable attorney fees arising out of, directly or indirectly, any claim of personal injury or death associated with such unintended or unauthorized use, even if such claim alleges that ON Semiconductor was negligent regarding the design or manufacture of the part. ON Semiconductor is an Equal Opportunity/Affirmative Action Employer. This literature is subject to all applicable copyright laws and is not for resale in any manner.



FPF1320 / FPF1321 IntelliMAX™ Dual-Input Single-Output Advanced Power Switch with True Reverse-Current Blocking

Features

- DISO Load Switches
- Input Supply Operating Range: 1.5 V ~ 5.5 V
- R_{ON} 50 mΩ at V_{IN}=3.3 V Per Channel (Typical)
- True Reverse-Current Blocking (TRCB)
- Fixed Slew Rate Controlled 130 μs for < 1 μF C_{OUT}
- I_{SW}: 1.5 A Per Channel (Maximum)
- Quick Discharge Feature on FPF1321
- Logic CMOS IO Meets JESD76 Standard for GPIO Interface and Related Power Supply Requirements
- ESD Protected:
 - Human Body Model: >6 kV
 - Charged Device Model: >1.5 kV
 - IEC 61000-4-2 Air Discharge: >15 kV
 - IEC 61000-4-2 Contact Discharge: >8 kV

Applications

- Smart phones / Tablet PCs
- Portable Devices
- Near Field Communication (NFC) Capable SIM Card Power Supply

Description

The FPF1320/21 is a Dual-Input Single-Output (DISO) load switch consisting of two sets of slew-rate controlled, low on-resistance, P-channel MOSFET switches and integrated analog features. The slew-rate-controlled turn-on characteristic prevents inrush current and the resulting excessive voltage droop on the power rails. The input voltage range operates from 1.5 V to 5.5 V to align with the requirements of low-voltage portable device power rails. FPF1320/21 performs seamless power-source transitions between two input power rails using the SEL pin with advanced break-before-make operation.

FPF1320/21 has a TRCB function to block unwanted reverse current from output to input during ON/OFF states. The switch is controlled by logic inputs of the SEL and EN pins, which are capable of interfacing directly with low-voltage control signals (GPIO).

FPF1321 has 65 Ω on-chip load resistor for output quick discharge when EN is LOW.

FPF1320/21 is available in 1.0 mm x 1.5 mm WLCSP, 6-bump, with 0.5 mm pitch. FPF1321B is available in 1.0 mm x 1.5 mm WLCSP, 6-bump, 0.5 mm pitch with backside laminate.

Ordering Information

Part Number	Top Mark	Channel	Switch Per Channel (Typ.) at 3.3 V _{IN}	Reverse Current Blocking	Output Discharge	Rise Time (t _R)	Package
FPF1320UCX	QS	DISO	50 mΩ	Yes	NA	130 μs	1.0 mm X 1.5 mm Wafer-Level Chip-Scale Package (WLCSP) 6-Bumps, 0.5 mm Pitch
FPF1321UCX	QT	DISO	50 mΩ	Yes	65 Ω	130 μs	
FPF1321BUCX	QT	DISO	50 mΩ	Yes	65 Ω	130 μs	1.0 mm X 1.5 mm Wafer-Level Chip-Scale Package (WLCSP) 6-Bumps, 0.5 mm Pitch with Backside Laminate

Application Diagram

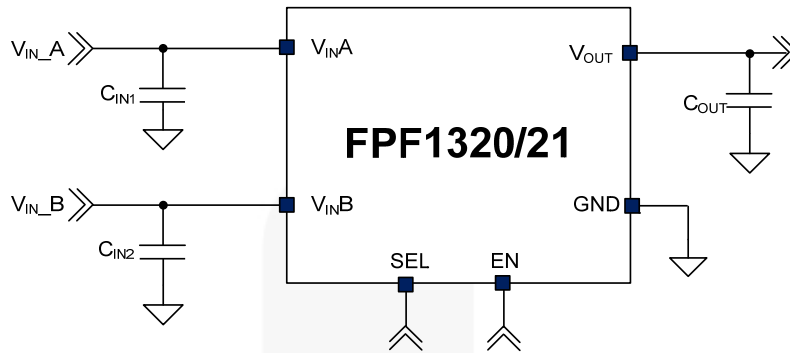

Figure 1. Typical Application

Block Diagram

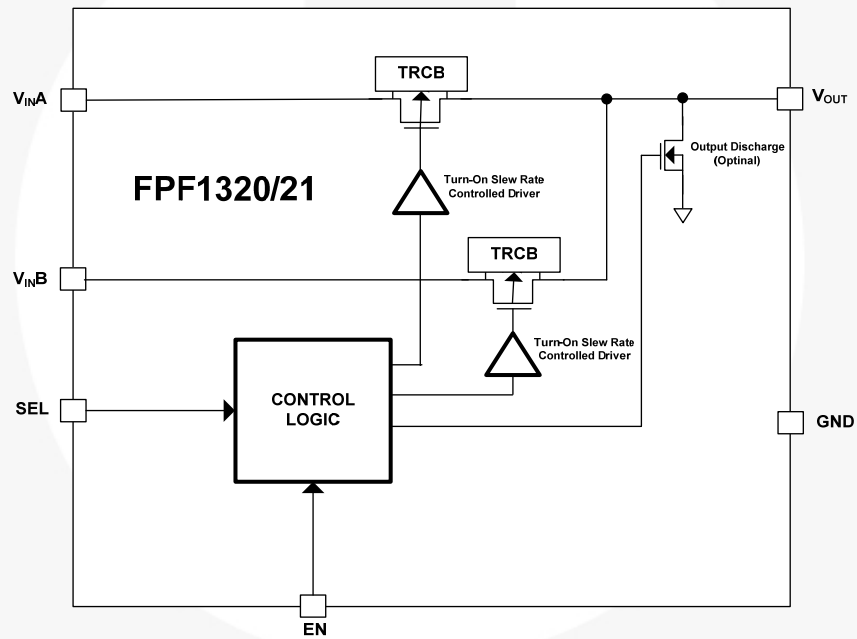

Figure 2. Functional Block Diagram (Output Discharge Path for FPF1321 Only)

Pin Configuration

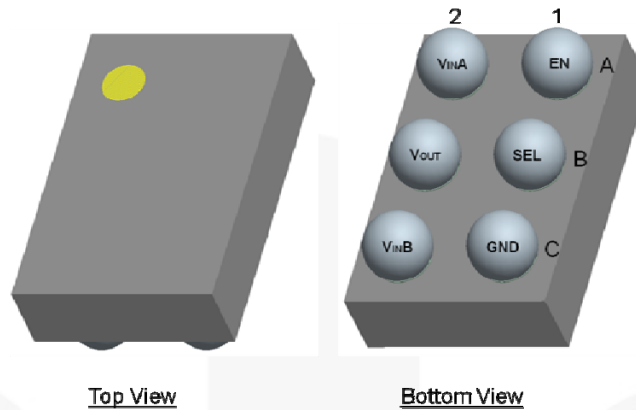

Figure 3. Pin Configuration in Package View with Pin 1 Indicator

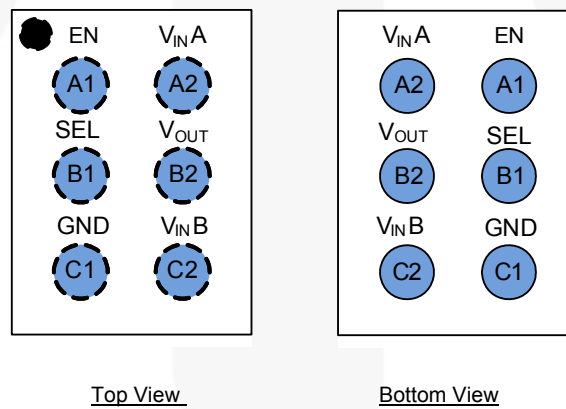

Figure 4. Pin Assignments

Pin Description

Pin #	Name	Description
A1	EN	Enable input. Active HIGH. There is an internal pull-down resistor at the EN pin.
B1	SEL	Input power selection inputs. See Table 1. There are internal pull-down resistors at the SEL pins.
A2	V _{IN A}	Supply Input. Input to the power switch A.
B2	V _{OUT}	Switch output
C1	GND	Ground
C2	V _{IN B}	Supply Input. Input to power switch B.

Table 1. Truth Table

SEL	EN	Switch A	Switch B	V _{OUT}	Status
LOW	HIGH	ON	OFF	V _{IN A}	V _{IN A} Selected
HIGH	HIGH	OFF	ON	V _{IN B}	V _{IN B} Selected
X	LOW	OFF	OFF	Floating for FPF1320 GND for FPF1321	Both Switches are OFF

Absolute Maximum Ratings

Stresses exceeding the Absolute Maximum Ratings may damage the device. The device may not function or be operable above the recommended operating conditions and stressing the parts to these levels is not recommended. In addition, extended exposure to stresses above the recommended operating conditions may affect device reliability. The absolute maximum ratings are stress ratings only.

Symbol	Parameters	Min.	Max.	Unit
V_{IN}	V_{INA} , V_{INB} , V_{SEL} , V_{EN} , V_{OUT} to GND	-0.3	6	V
I_{SW}	Maximum Continuous Switch Current per Channel		1.5	A
P_D	Total Power Dissipation at $T_A=25^\circ\text{C}$		1.2	W
T_{STG}	Operating and Storage Junction Temperature	-65	150	$^\circ\text{C}$
Θ_{JA}	Thermal Resistance, Junction-to-Ambient (1 in. ² Pad of 2-oz. Copper)		85 ⁽¹⁾	$^\circ\text{C/W}$
			110 ⁽²⁾	
ESD	Electrostatic Discharge Capability	Human Body Model, JESD22-A114	6.0	kV
		Charged Device Model, JESD22-C101	1.5	
		Air Discharge (V_{INA} , V_{INB} to GND), IEC61000-4-2 System Level	15.0	
		Contact Discharge (V_{INA} , V_{INB} to GND), IEC61000-4-2 System Level	8.0	

Notes:

1. Measured using 2S2P JEDEC std. PCB.
2. Measured using 2S2P JEDEC PCB cold-plate method.

Recommended Operating Conditions

The Recommended Operating Conditions table defines the conditions for actual device operation. Recommended operating conditions are specified to ensure optimal performance to the datasheet specifications. Fairchild does not recommend exceeding them or designing to Absolute Maximum Ratings.

Symbol	Parameters	Min.	Max.	Unit
V_{IN}	Input Voltage on V_{INA} , V_{INB}	1.5	5.5	V
T_A	Ambient Operating Temperature	-40	85	$^\circ\text{C}$

Electrical Characteristics

$V_{IN A}=V_{IN B}=1.5$ to 5.5 V, $T_A=-40$ to 85°C unless otherwise noted. Typical values are at $V_{IN A}=V_{IN B}=3.3$ V and $T_A=25^\circ\text{C}$.

Symbol	Parameters	Condition	Min.	Typ.	Max.	Unit
Basic Operation						
$V_{IN A}, V_{IN B}$	Input Voltage		1.5		5.5	V
I_{SD}	Shutdown Current	SEL=HIGH or LOW, EN=GND, $V_{OUT}=GND$, $V_{IN A}=V_{IN B}=5.5$ V			5	μA
I_Q	Quiescent Current	$I_{OUT}=0\text{mA}$, SEL=HIGH or LOW, EN=HIGH, $V_{IN A}=V_{IN B}=5.5$ V		12	22	μA
R_{ON}	On-Resistance	$V_{IN A}=V_{IN B}=5.5$ V, $I_{OUT}=200$ mA, $T_A=25^\circ\text{C}$		42	60	m Ω
		$V_{IN A}=V_{IN B}=3.3$ V, $I_{OUT}=200$ mA, $T_A=25^\circ\text{C}$		50		
		$V_{IN A}=V_{IN B}=1.8$ V, $I_{OUT}=200$ mA, $T_A=25^\circ\text{C}$ to 85°C		80		
		$V_{IN A}=V_{IN B}=1.5$ V, $I_{OUT}=200$ mA, $T_A=25^\circ\text{C}$			170	
V_{IH}	SEL, EN Input Logic High Voltage	$V_{IN A}, V_{IN B}=1.5$ V – 5.5 V	1.15			V
V_{IL}	SEL, EN Input Logic Low Voltage	$V_{IN A}, V_{IN B}=1.8$ V – 5.5 V			0.65	V
	SEL, EN Input Logic Low Voltage	$V_{IN A}, V_{IN B}=1.5$ V – 1.8 V			0.60	
V_{DROOP_OUT}	Output Voltage Droop while Channel Switching from Higher Input Voltage Lower Input Voltage ⁽³⁾	$V_{IN A}=3.3$ V, $V_{IN B}=5$ V, Switching from $V_{IN A} \rightarrow V_{IN B}$, $R_L=150$ Ω , $C_{OUT}=1$ μF			100	mV
I_{SEL}/I_{EN}	Input Leakage at SEL and EN Pin				1.2	μA
R_{SEL_PD}/R_{EN_PD}	Pull-Down Resistance at SEL or EN Pin			7		M Ω
R_{PD}	Output Pull-Down Resistance	SEL=HIGH or LOW, EN=GND, $I_{FORCE}=20$ mA, $T_A=25^\circ\text{C}$, FPF1321		65		Ω
True Reverse Current Blocking						
V_{T_RCB}	RCB Protection Trip Point	$V_{OUT} - V_{IN A}$ or $V_{IN B}$		45		mV
V_{R_RCB}	RCB Protection Release Trip Point	$V_{IN A}$ or $V_{IN B} - V_{OUT}$		25		mV
I_{RCB}	$V_{IN A}$ or $V_{IN B}$ Current During RCB	$V_{OUT}=5.5$ V, $V_{IN A}$ or $V_{IN B}$ =Short to GND		9	15	μA
t_{RCB_ON}	RCB Response Time when Device is ON ⁽³⁾	$V_{IN A}$ or $V_{IN B}=5$ V, $V_{OUT}V_{IN A,B}=100$ mV		5		μs

Continued on the following page...

Electrical Characteristics (Continued)

 $V_{IN A}=V_{IN B}=1.5$ to 5.5 V, $T_A=-40$ to 85°C unless otherwise noted. Typical values are at $V_{IN A}=V_{IN B}=3.3$ V and $T_A=25^\circ\text{C}$.

Symbol	Parameters	Condition	Min.	Typ.	Max.	Unit
Dynamic Characteristics						
t_{DON}	Turn-On Delay ⁽⁴⁾	$V_{IN A}$ or $V_{IN B}=3.3$ V, $R_L=150$ Ω , $C_L=1$ μF , $T_A=25^\circ\text{C}$, SEL: HIGH, EN: LOW \rightarrow HIGH		120		μs
t_R	V_{OUT} Rise Time ⁽⁴⁾			130		μs
t_{ON}	Turn-On Time ⁽⁶⁾			250		μs
t_{DOFF}	Turn-Off Delay ⁽⁴⁾	$V_{IN A}$ or $V_{IN B}=3.3$ V, $R_L=150$ Ω , $C_L=1$ μF , $T_A=25^\circ\text{C}$, SEL: HIGH, EN: HIGH \rightarrow LOW		15		μs
t_F	V_{OUT} Fall Time ⁽⁴⁾			320		μs
t_{OFF}	Turn-Off Time ⁽⁷⁾			335		μs
t_{DOFF}	Turn-Off Delay ^(4,5)	$V_{IN A}$ or $V_{IN B}=3.3$ V, $R_L=150$ Ω , $C_L=1$ μF , $T_A=25^\circ\text{C}$, SEL: HIGH, EN: HIGH \rightarrow LOW, Output Discharge Mode, FPF1321		6		μs
t_F	V_{OUT} Fall Time ^(4,5)			110		μs
t_{OFF}	Turn-Off Time ^(5,7)			116		μs
t_{TRANR}	Transition Time LOW \rightarrow HIGH ⁽⁴⁾	$V_{IN A}=3.3$ V, $V_{IN B}=5$ V, Switching from $V_{IN A} \rightarrow V_{IN B}$, SEL: LOW \rightarrow HIGH, EN: HIGH, $R_L=150$ Ω , $C_L=1$ μF , $T_A=25^\circ\text{C}$		3		μs
t_{SLH}	Switch-Over Rising Delay ⁽⁴⁾			1		μs
t_{TRANF}	Transition Time HIGH \rightarrow LOW ⁽⁴⁾	$V_{IN A}=3.3$ V, $V_{IN B}=5$ V, Switching from $V_{IN B} \rightarrow V_{IN A}$, SEL: HIGH \rightarrow LOW, EN: HIGH, $R_L=150$ Ω , $C_L=1$ μF , $T_A=25^\circ\text{C}$		45		μs
t_{SHL}	Switch-Over Falling Delay ⁽⁴⁾			5		μs

Notes:

- This parameter is guaranteed by design and characterization; not production tested.
- $t_{DON}/t_{DOFF}/t_R/t_F/t_{TRANR}/t_{TRANF}/t_{SLH}/t_{SHL}$ are defined in Figure 5.
- FPF1321 output discharge is enabled during off.
- $t_{ON}=t_R + t_{DON}$.
- $t_{OFF}=t_F + t_{DOFF}$.

Timing Diagram

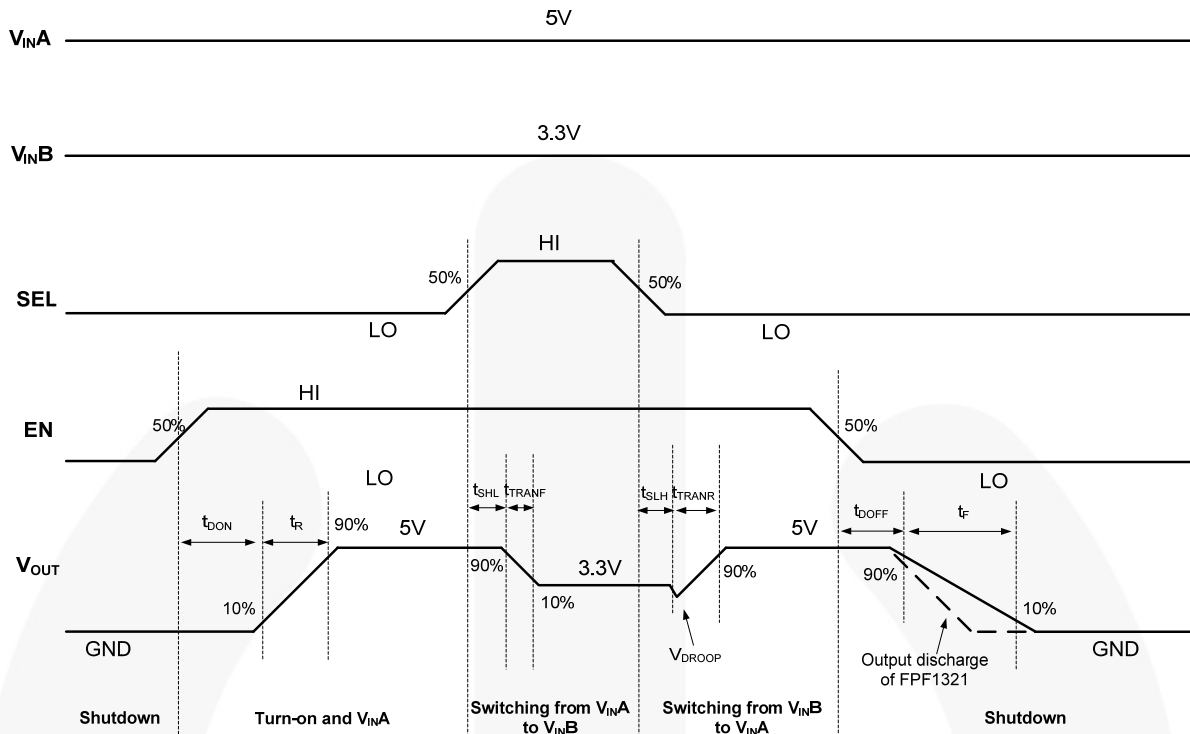

Figure 5. Dynamic Behavior Timing Diagram

Typical Characteristics

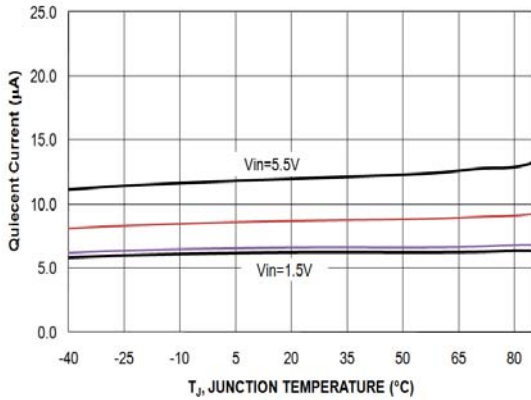

Figure 6. Supply Current vs. Temperature

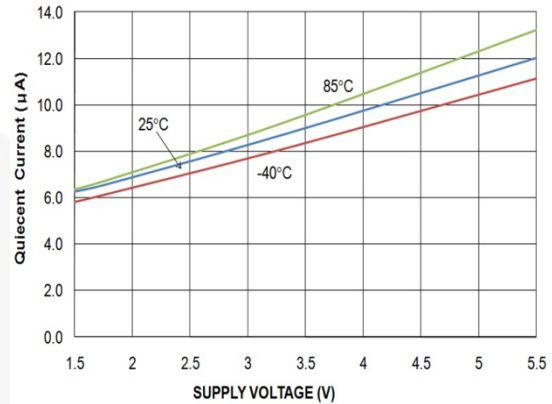

Figure 7. Supply Current vs. Supply Voltage

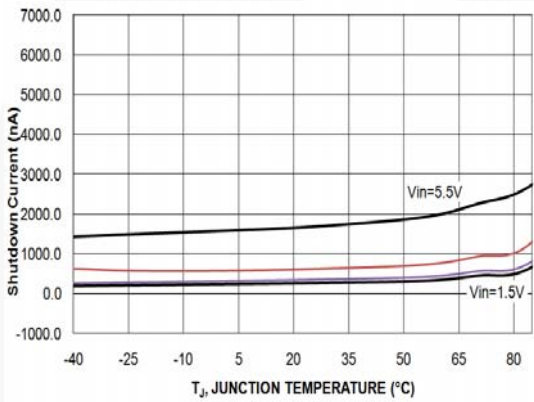

Figure 8. Shutdown Current vs. Temperature

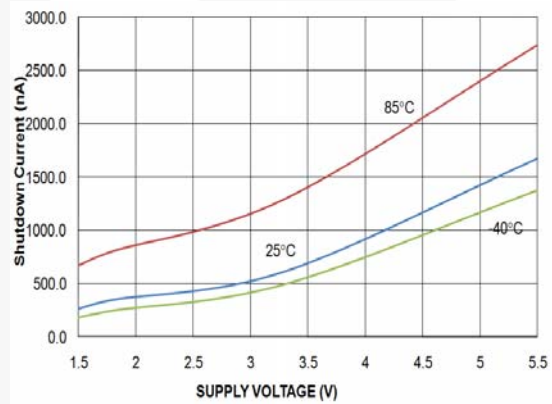

Figure 9. Shutdown Current vs. Supply Voltage

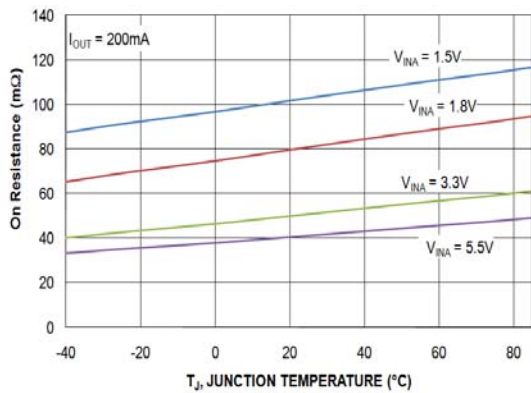

Figure 10. R_{ON} vs. Temperature

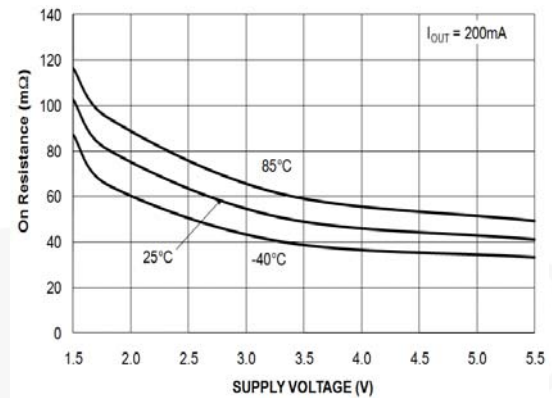

Figure 11. R_{ON} vs. Supply Voltage

Continued on the following page...

Typical Characteristics

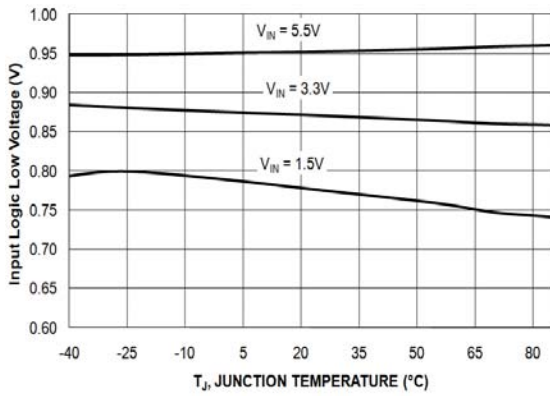

Figure 12. V_{IL} vs. Temperature

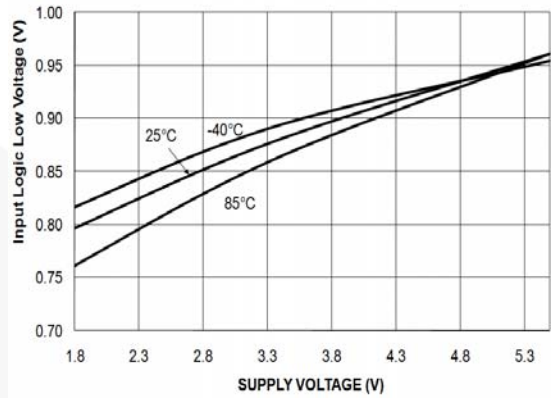

Figure 13. V_{IL} vs. Supply Voltage

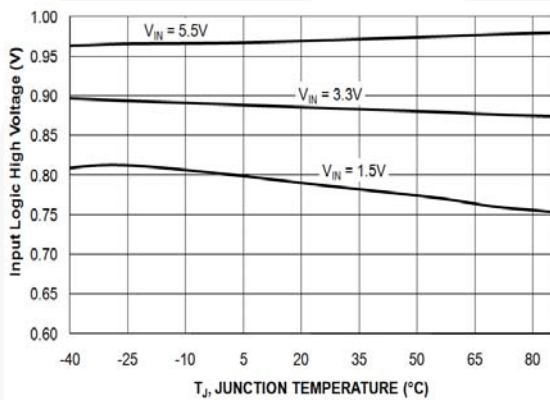

Figure 14. V_{IH} vs. Temperature

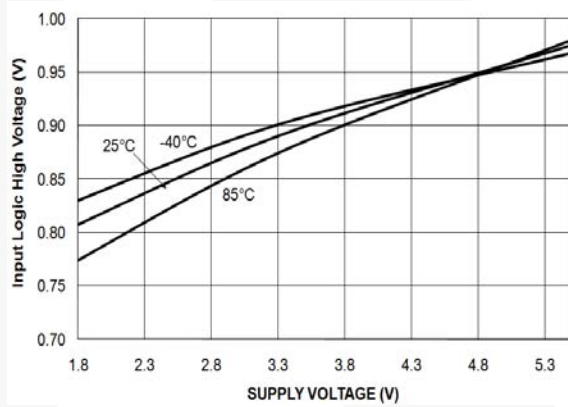

Figure 15. V_{IH} vs. Supply Voltage

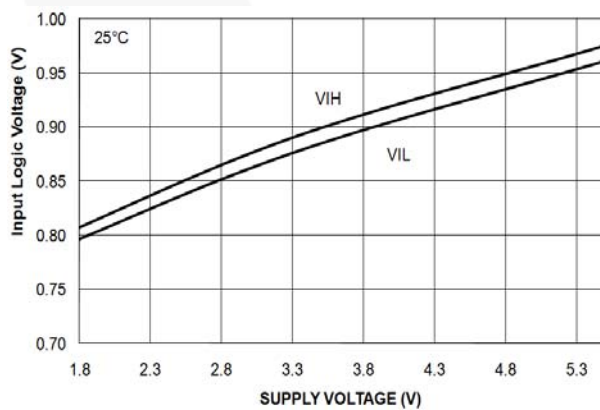

Figure 16. V_{IH} / V_{IL} vs. Supply Voltage

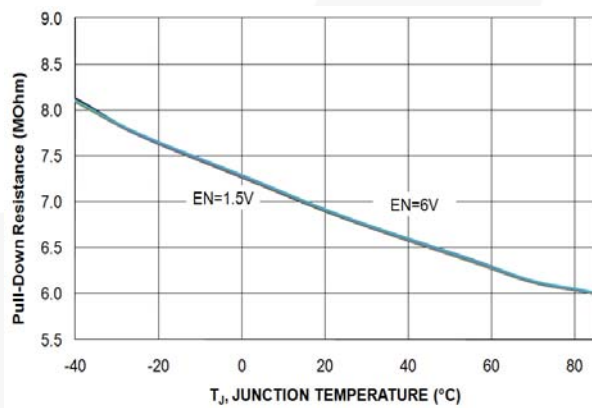

Figure 17. R_{SEL_PD} and R_{EN_PD} vs. Temperature

Continued on the following page...

Typical Characteristics

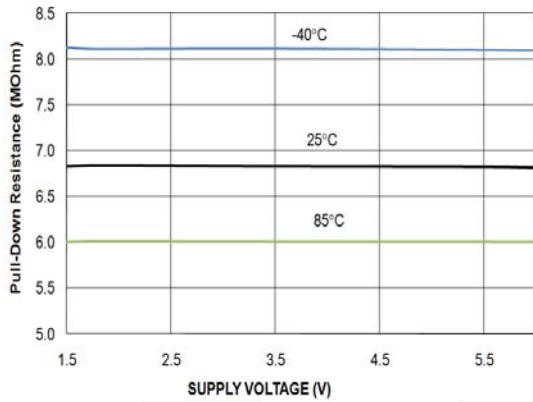

Figure 18. R_{SEL_PD} and R_{EN_PD} vs. Supply Voltage

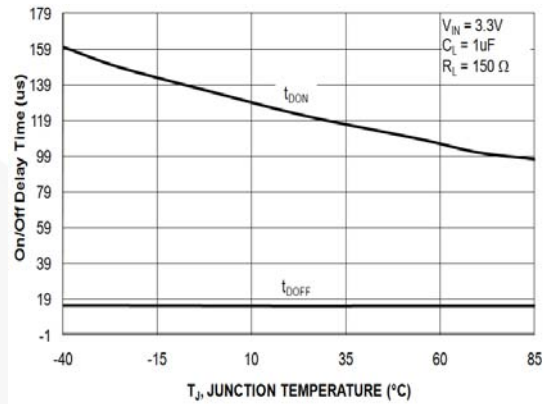

Figure 19. t_{DON} and t_{DOFF} vs. Temperature

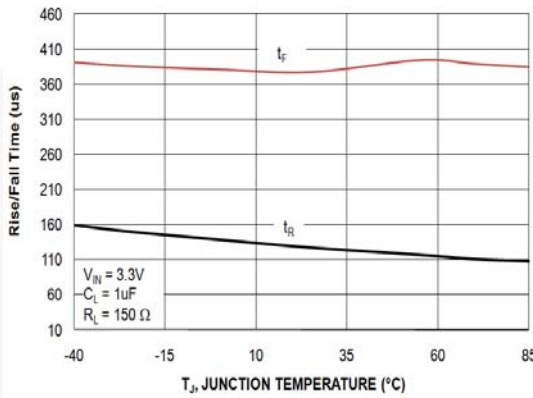

Figure 20. t_R and t_F with FPF1320 vs. Temperature

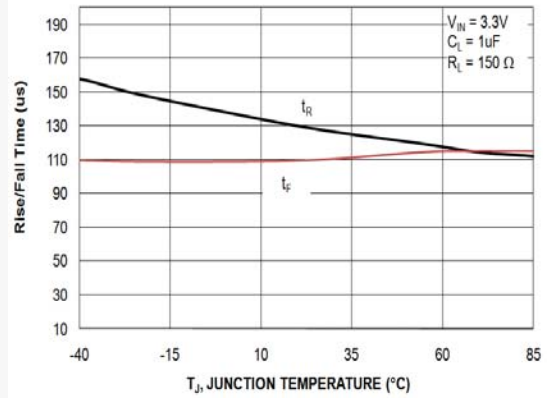

Figure 21. t_R and t_F with FPF1321 vs. Temperature

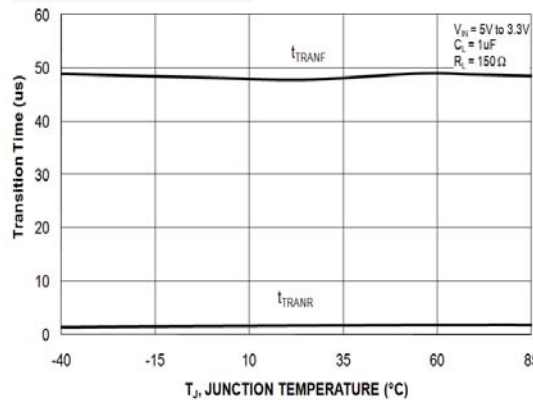

Figure 22. Transition Time vs. Temperature

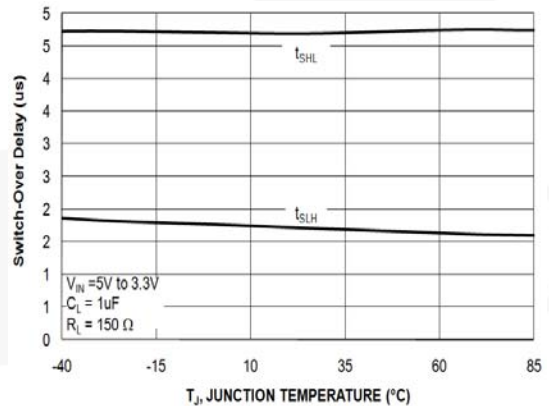

Figure 23. Switch Over Time vs. Temperature

Continued on the following page...

Typical Characteristics

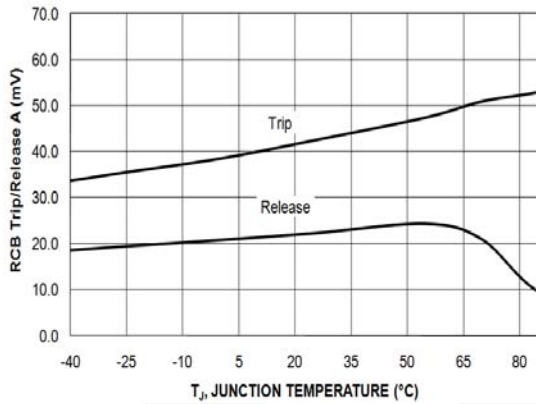

Figure 24. TRCB Trip and Release vs. Temperature

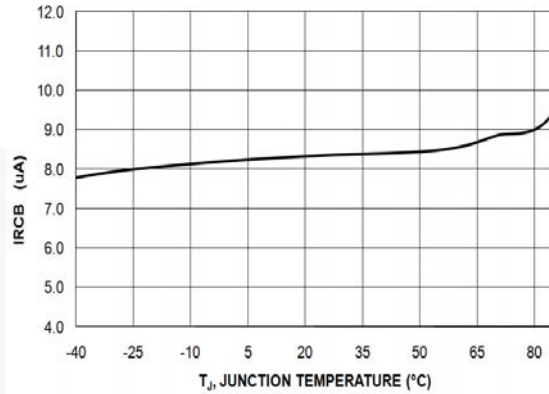

Figure 25. I_{RCB} vs. Temperature

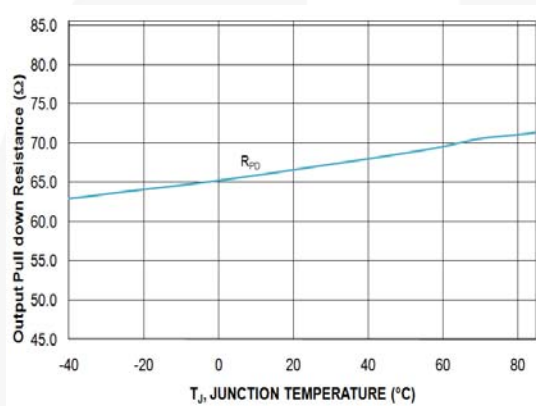

Figure 26. R_{PD} with FPF1321 vs. Temperature

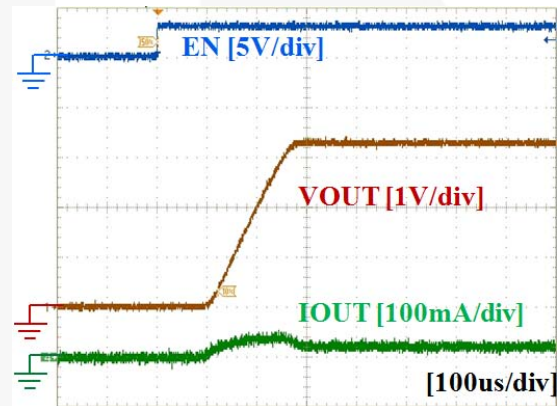

Figure 27. Turn-On Response
($V_{IN A}=3.3\text{ V}$, $C_{IN}=1\text{ }\mu\text{F}$, $C_{OUT}=1\text{ }\mu\text{F}$, $R_L=150\text{ }\Omega$,
 $SEL=LOW$)

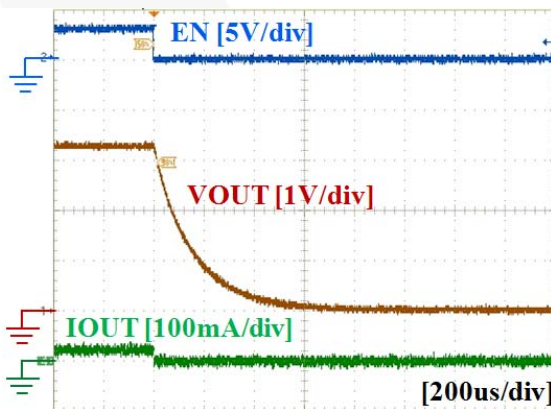

Figure 28. Turn-Off Response with FPF1320
($V_{IN A}=3.3\text{ V}$, $C_{IN}=1\text{ }\mu\text{F}$, $C_{OUT}=1\text{ }\mu\text{F}$, $R_L=150\text{ }\Omega$,
 $SEL=LOW$)

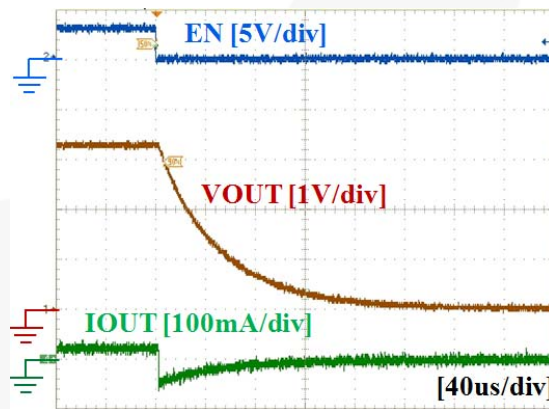

Figure 29. Turn-Off Response with FPF1321
($V_{IN A}=3.3\text{ V}$, $C_{IN}=1\text{ }\mu\text{F}$, $C_{OUT}=1\text{ }\mu\text{F}$, $R_L=150\text{ }\Omega$,
 $SEL=LOW$)

Continued on the following page...

Typical Characteristics

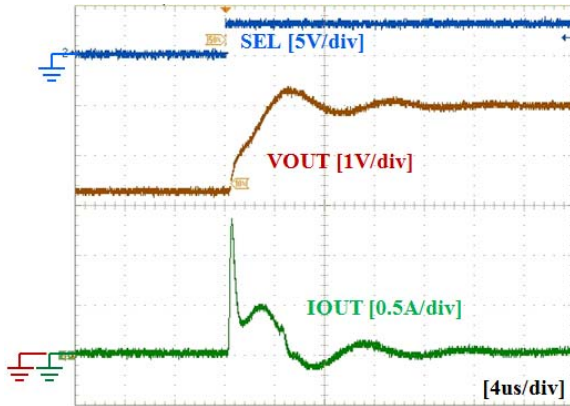

Figure 30. Power Source Transition from 3.3 V to 5 V ($V_{IN A}=3.3$ V, $V_{IN B}=5$ V, $C_{IN}=1$ μ F, $C_{OUT}=1$ μ F, $R_L=150$ Ω)

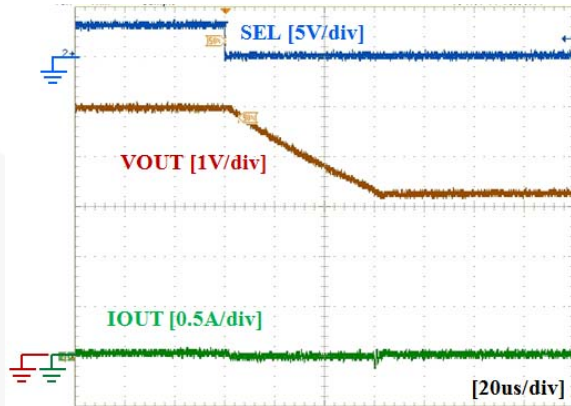

Figure 31. Power Source Transition from 5 V to 3.3 V ($V_{IN A}=3.3$ V, $V_{IN B}=5$ V, $C_{IN}=1$ μ F, $C_{OUT}=1$ μ F, $R_L=150$ Ω)

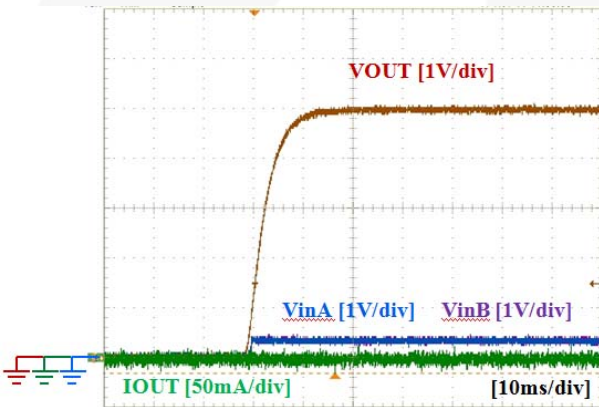

Figure 32. TRCB During Off ($V_{IN A}=V_{IN B}$ =Floating, $V_{OUT}=5$ V, $C_{IN}=1$ μ F, $C_{OUT}=1$ μ F, $EN=LOW$, No R_L)

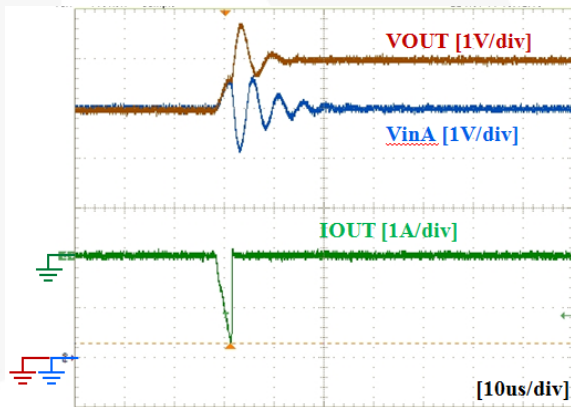

Figure 33. TRCB During On ($V_{IN A}=5$ V, $V_{OUT}=6$ V, $C_{IN}=1$ μ F, $C_{OUT}=1$ μ F, $EN=HIGH$, No R_L)

Operation and Application Description

The FPF1320 and FPF1321 are dual-input single-output power multiplexer switches with controlled turn-on and seamless power source transition. The core is a 50 mΩ P-channel MOSFET and controller capable of functioning over a wide input operating range of 1.5 V to 5.5 V per channel. The EN and SEL pins are active-HIGH, GPIO/CMOS-compatible input. They control the state of the switch and input power source selection, respectively. TRCB functionality blocks unwanted reverse current during both ON and OFF states when higher V_{OUT} than $V_{IN A}$ or $V_{IN B}$ is applied. FPF1321 has a 65 Ω output discharge path during off.

Input Capacitor

To limit the voltage drop on the input supply caused by transient inrush current when the switch turns on into a discharged load capacitor; a capacitor must be placed between the $V_{IN A}$ or $V_{IN B}$ pins to the GND pin. At least 1 μF ceramic capacitor, C_{IN} , placed close to the pins, is usually sufficient. Higher-value C_{IN} can be used to reduce more the voltage drop.

Inrush Current

Inrush current occurs when the device is turned on. Inrush current is dependent on output capacitance and slew rate control capability, as expressed by:

$$I_{INRUSH} = C_{OUT} \times \frac{V_{IN} - V_{INITIAL}}{t_R} + I_{LOAD} \quad (1)$$

where:

C_{OUT} : Output capacitance;

t_R : Slew rate or rise time at V_{OUT} ;

V_{IN} : Input voltage, $V_{IN A}$ or $V_{IN B}$;

$V_{INITIAL}$: Initial voltage at C_{OUT} , usually GND; and

I_{LOAD} : Load current.

Higher inrush current causes higher input voltage drop, depending on the distributed input resistance and input capacitance. High inrush current can cause problems.

FPF1320/1 has a 130 μs of slew rate capability under 3.3 V_{IN} at 1 μF of C_{OUT} and 150 Ω of R_L so inrush current and input voltage drop can be minimized.

Power Source Selection

Input power source selection can be controlled by the SEL pin. When SEL is LOW, output is powered from $V_{IN A}$ while SEL is HIGH, $V_{IN B}$ is powering output. The SEL signal is ignored during device OFF.

Output Voltage Drop during Transition

Output voltage drop usually occurs during input power source transition period from low voltage to high voltage. The drop is highly dependent on output capacitance and load current.

FPF1320/1 adopts an advanced break-before-make control, which can result in minimized output voltage drop during the transition time.

Output Capacitor

Capacitor C_{OUT} of at least 1 μF is highly recommended between the V_{OUT} and GND pins to achieve minimized output voltage drop during input power source transition. This capacitor also prevents parasitic board inductance.

True Reverse-Current Blocking

The true reverse-current blocking feature protects the input source against current flow from output to input regardless of whether the load switch is on or off.

Board Layout

For best performance, all traces should be as short as possible. To be most effective, the input and output capacitors should be placed close to the device to minimize the effect that parasitic trace inductance on normal and short-circuit operation. Wide traces or large copper planes for power pins ($V_{IN A}$, $V_{IN B}$, V_{OUT} and GND) minimize the parasitic electrical effects and the thermal impedance.

Physical Dimensions

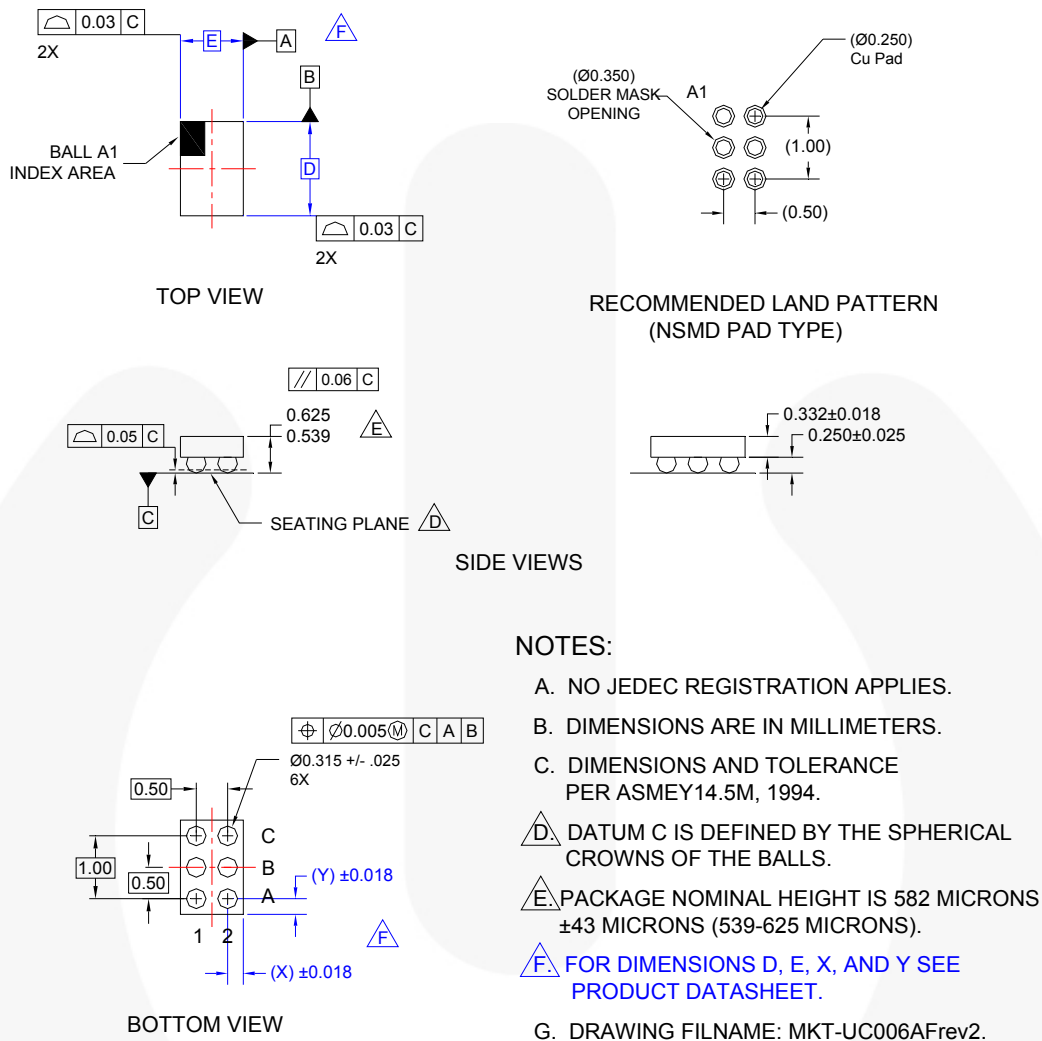

Figure 34. 6-Ball, 1.0 x 1.5 mm, Wafer-Level Chip-Scale Package (WLCSP)

Product-Specific Dimensions

Product	D	E	X	Y
FPF1320UCX	1460 µm ±30 µm	960 µm ±30 µm	230 µm	230 µm
FPF1321UCX	1460 µm ±30 µm	960 µm ±30 µm	230 µm	230 µm
FPF1321BUCX	1460 µm ±30 µm	960 µm ±30 µm	230 µm	230 µm

Package drawings are provided as a service to customers considering Fairchild components. Drawings may change in any manner without notice. Please note the revision and/or date on the drawing and contact a Fairchild Semiconductor representative to verify or obtain the most recent revision. Package specifications do not expand the terms of Fairchild's worldwide terms and conditions, specifically the warranty therein, which covers Fairchild products.

Always visit Fairchild Semiconductor's online packaging area for the most recent package drawings:

<http://www.fairchildsemi.com/packaging/>

<http://www.fairchildsemi.com/dwg/UC/UC006AF.pdf>



TRADEMARKS

The following includes registered and unregistered trademarks and service marks, owned by Fairchild Semiconductor and/or its global subsidiaries, and is not intended to be an exhaustive list of all such trademarks:

- | | | | |
|---|--|--|---|
| AccuPower™ | F-PFST™ |  | Sync-Lock™ |
| AX-CAP [®] | FRFET [®] | PowerTrench [®] |  |
| BitSiC™ | Global Power Resource SM | PowerXS™ | TinyBoost [®] |
| Build it Now™ | GreenBridge™ | Programmable Active Droop™ | TinyBuck [®] |
| CorePLUS™ | Green FPS™ | QFET [®] | TinyCalc™ |
| CorePOWER™ | Green FPS™ e-Series™ | QST™ | TinyLogic [®] |
| CROSSVOLT™ | Gmax™ | Quiet Series™ | TINYOPTO™ |
| CTL™ | GTO™ | RapidConfigure™ | TinyPower™ |
| Current Transfer Logic™ | IntelliMAX™ |  Saving our world, 1mW/WkV at a time™ | TinyPWM™ |
| DEUXPEED [®] | ISOPLANAR™ | SignalWise™ | TinyWire™ |
| Dual Cool™ | Making Small Speakers Sound Louder and Better™ | SmartMax™ | TranSiC™ |
| EcoSPARK [®] | MegaBuck™ | SMART START™ | TriFault Detect™ |
| EfficientMax™ | MICROCOUPLER™ | Solutions for Your Success™ | TRUECURRENT [®] |
| ESBC™ | MicroFET™ | SPM [®] | μSerDes™ |
|  | MicroPak™ | STEALTH™ |  |
| Fairchild [®] | MicroPak2™ | SuperFET [®] | UHC [®] |
| Fairchild Semiconductor [®] | MillerDrive™ | SuperSOT™-3 | Ultra FRFET™ |
| FACT Quiet Series™ | MotionMax™ | SuperSOT™-8 | UniFET™ |
| FACT [®] | mWSaver [®] | SuperSOT™-8 | VCX™ |
| FAST [®] | OptoHiT™ | SupreMOS [®] | VisualMax™ |
| FastvCore™ | OPTOLOGIC [®] | SyncFET™ | VoltagePlus™ |
| FETBench™ | OPTOPLANAR [®] | | XS™ |
| FPS™ | | | |

* Trademarks of System General Corporation, used under license by Fairchild Semiconductor.

DISCLAIMER

FAIRCHILD SEMICONDUCTOR RESERVES THE RIGHT TO MAKE CHANGES WITHOUT FURTHER NOTICE TO ANY PRODUCTS HEREIN TO IMPROVE RELIABILITY, FUNCTION, OR DESIGN. FAIRCHILD DOES NOT ASSUME ANY LIABILITY ARISING OUT OF THE APPLICATION OR USE OF ANY PRODUCT OR CIRCUIT DESCRIBED HEREIN; NEITHER DOES IT CONVEY ANY LICENSE UNDER ITS PATENT RIGHTS, NOR THE RIGHTS OF OTHERS. THESE SPECIFICATIONS DO NOT EXPAND THE TERMS OF FAIRCHILD'S WORLDWIDE TERMS AND CONDITIONS, SPECIFICALLY THE WARRANTY THEREIN, WHICH COVERS THESE PRODUCTS.

LIFE SUPPORT POLICY

FAIRCHILD'S PRODUCTS ARE NOT AUTHORIZED FOR USE AS CRITICAL COMPONENTS IN LIFE SUPPORT DEVICES OR SYSTEMS WITHOUT THE EXPRESS WRITTEN APPROVAL OF FAIRCHILD SEMICONDUCTOR CORPORATION.

As used herein:

1. Life support devices or systems are devices or systems which, (a) are intended for surgical implant into the body or (b) support or sustain life, and (c) whose failure to perform when properly used in accordance with instructions for use provided in the labeling, can be reasonably expected to result in a significant injury of the user.
2. A critical component in any component of a life support, device, or system whose failure to perform can be reasonably expected to cause the failure of the life support device or system, or to affect its safety or effectiveness.

ANTI-COUNTERFEITING POLICY

Fairchild Semiconductor Corporation's Anti-Counterfeiting Policy. Fairchild's Anti-Counterfeiting Policy is also stated on our external website, www.fairchildsemi.com, under Sales Support.

Counterfeiting of semiconductor parts is a growing problem in the industry. All manufacturers of semiconductor products are experiencing counterfeiting of their parts. Customers who inadvertently purchase counterfeit parts experience many problems such as loss of brand reputation, substandard performance, failed applications, and increased cost of production and manufacturing delays. Fairchild is taking strong measures to protect ourselves and our customers from the proliferation of counterfeit parts. Fairchild strongly encourages customers to purchase Fairchild parts either directly from Fairchild or from Authorized Fairchild Distributors who are listed by country on our web page cited above. Products customers buy either from Fairchild directly or from Authorized Fairchild Distributors are genuine parts, have full traceability, meet Fairchild's quality standards for handling and storage and provide access to Fairchild's full range of up-to-date technical and product information. Fairchild and our Authorized Distributors will stand behind all warranties and will appropriately address any warranty issues that may arise. Fairchild will not provide any warranty coverage or other assistance for parts bought from Unauthorized Sources. Fairchild is committed to combat this global problem and encourage our customers to do their part in stopping this practice by buying direct or from authorized distributors.

PRODUCT STATUS DEFINITIONS

Definition of Terms

Datasheet Identification	Product Status	Definition
Advance Information	Formative / In Design	Datasheet contains the design specifications for product development. Specifications may change in any manner without notice.
Preliminary	First Production	Datasheet contains preliminary data; supplementary data will be published at a later date. Fairchild Semiconductor reserves the right to make changes at any time without notice to improve design.
No Identification Needed	Full Production	Datasheet contains final specifications. Fairchild Semiconductor reserves the right to make changes at any time without notice to improve the design.
Obsolete	Not In Production	Datasheet contains specifications on a product that is discontinued by Fairchild Semiconductor. The datasheet is for reference information only.

Rev. 166

ON Semiconductor and  are trademarks of Semiconductor Components Industries, LLC dba ON Semiconductor or its subsidiaries in the United States and/or other countries. ON Semiconductor owns the rights to a number of patents, trademarks, copyrights, trade secrets, and other intellectual property. A listing of ON Semiconductor's product/patent coverage may be accessed at www.onsemi.com/site/pdf/Patent-Marking.pdf. ON Semiconductor reserves the right to make changes without further notice to any products herein. ON Semiconductor makes no warranty, representation or guarantee regarding the suitability of its products for any particular purpose, nor does ON Semiconductor assume any liability arising out of the application or use of any product or circuit, and specifically disclaims any and all liability, including without limitation special, consequential or incidental damages. Buyer is responsible for its products and applications using ON Semiconductor products, including compliance with all laws, regulations and safety requirements or standards, regardless of any support or applications information provided by ON Semiconductor. "Typical" parameters which may be provided in ON Semiconductor data sheets and/or specifications can and do vary in different applications and actual performance may vary over time. All operating parameters, including "Typicals" must be validated for each customer application by customer's technical experts. ON Semiconductor does not convey any license under its patent rights nor the rights of others. ON Semiconductor products are not designed, intended, or authorized for use as a critical component in life support systems or any FDA Class 3 medical devices or medical devices with a same or similar classification in a foreign jurisdiction or any devices intended for implantation in the human body. Should Buyer purchase or use ON Semiconductor products for any such unintended or unauthorized application, Buyer shall indemnify and hold ON Semiconductor and its officers, employees, subsidiaries, affiliates, and distributors harmless against all claims, costs, damages, and expenses, and reasonable attorney fees arising out of, directly or indirectly, any claim of personal injury or death associated with such unintended or unauthorized use, even if such claim alleges that ON Semiconductor was negligent regarding the design or manufacture of the part. ON Semiconductor is an Equal Opportunity/Affirmative Action Employer. This literature is subject to all applicable copyright laws and is not for resale in any manner.

PUBLICATION ORDERING INFORMATION

LITERATURE FULFILLMENT:

Literature Distribution Center for ON Semiconductor
19521 E. 32nd Pkwy, Aurora, Colorado 80011 USA
Phone: 303-675-2175 or 800-344-3860 Toll Free USA/Canada
Fax: 303-675-2176 or 800-344-3867 Toll Free USA/Canada
Email: orderlit@onsemi.com

N. American Technical Support: 800-282-9855 Toll Free
USA/Canada
Europe, Middle East and Africa Technical Support:
Phone: 421 33 790 2910
Japan Customer Focus Center
Phone: 81-3-5817-1050

ON Semiconductor Website: www.onsemi.com
Order Literature: <http://www.onsemi.com/orderlit>
For additional information, please contact your local
Sales Representative