



Is Now Part of



ON Semiconductor®

To learn more about ON Semiconductor, please visit our website at
www.onsemi.com

Please note: As part of the Fairchild Semiconductor integration, some of the Fairchild orderable part numbers will need to change in order to meet ON Semiconductor's system requirements. Since the ON Semiconductor product management systems do not have the ability to manage part nomenclature that utilizes an underscore (_), the underscore (_) in the Fairchild part numbers will be changed to a dash (-). This document may contain device numbers with an underscore (_). Please check the ON Semiconductor website to verify the updated device numbers. The most current and up-to-date ordering information can be found at www.onsemi.com. Please email any questions regarding the system integration to Fairchild_questions@onsemi.com.

ON Semiconductor and the ON Semiconductor logo are trademarks of Semiconductor Components Industries, LLC dba ON Semiconductor or its subsidiaries in the United States and/or other countries. ON Semiconductor owns the rights to a number of patents, trademarks, copyrights, trade secrets, and other intellectual property. A listing of ON Semiconductor's product/patent coverage may be accessed at www.onsemi.com/site/pdf/Patent-Marking.pdf. ON Semiconductor reserves the right to make changes without further notice to any products herein. ON Semiconductor makes no warranty, representation or guarantee regarding the suitability of its products for any particular purpose, nor does ON Semiconductor assume any liability arising out of the application or use of any product or circuit, and specifically disclaims any and all liability, including without limitation special, consequential or incidental damages. Buyer is responsible for its products and applications using ON Semiconductor products, including compliance with all laws, regulations and safety requirements or standards, regardless of any support or applications information provided by ON Semiconductor. "Typical" parameters which may be provided in ON Semiconductor data sheets and/or specifications can and do vary in different applications and actual performance may vary over time. All operating parameters, including "Typicals" must be validated for each customer application by customer's technical experts. ON Semiconductor does not convey any license under its patent rights nor the rights of others. ON Semiconductor products are not designed, intended, or authorized for use as a critical component in life support systems or any FDA Class 3 medical devices or medical devices with a same or similar classification in a foreign jurisdiction or any devices intended for implantation in the human body. Should Buyer purchase or use ON Semiconductor products for any such unintended or unauthorized application, Buyer shall indemnify and hold ON Semiconductor and its officers, employees, subsidiaries, affiliates, and distributors harmless against all claims, costs, damages, and expenses, and reasonable attorney fees arising out of, directly or indirectly, any claim of personal injury or death associated with such unintended or unauthorized use, even if such claim alleges that ON Semiconductor was negligent regarding the design or manufacture of the part. ON Semiconductor is an Equal Opportunity/Affirmative Action Employer. This literature is subject to all applicable copyright laws and is not for resale in any manner.

FAN5345

具有单线数字接口的串联升压型LED驱动器

产品特性

- 异步升压变换器
- 驱动串联LED:
 - FAN5345S20X:20V 输出
 - FAN5345S30X:30V 输出
- 输入电压范围: 2.5V–5.5V
- 单线数控接口, 可设置LED亮度等级
 - 32级线性调整
- 1.2MHz 固定开关频率
- 软启动
- 输入欠压锁定(UVLO)
- 输出过压保护(OVP)
- 短路检测
- 热关闭保护(TSD)
- 小尺寸6引线SSOT23封装

适用范围

- 移动电话
- 移动互联网设备
- 便携式媒体播放器
- PDA、DSC、MP3 播放器

说明

FAN5245是一种异步恒流LED驱动器, 采用串联驱动方式使每颗LED具有同等亮度。当输出电压为20V时, FAN5345S20X可以驱动5只串联LED。当输出电压为30V时, 可以驱动8只串联LED。其固定开关频率为1.2MHz, 允许使用小电感与小电容, 因此在小尺寸应用场合中, 该驱动器成为优先选用器件。

FAN5345采用单线数控接口, 可通过数字脉冲对LED的亮度进行32级线性调整。

安全方面, 器件整合了过压、过流、短路检测和热关闭保护功能。此外, 若电池电压过低将触发输入欠压闭锁保护。

FAN5345采用6线SSOT23封装。

FAN5345符合“绿色”和RoHS标准。(有关飞兆半导体“绿色”的定义, 请参考

<http://www.fairchildsemi.com/company/green/index.html>)。

订购信息

器件型号	输出电压选择	温度范围	封装
FAN5345S20X	20V	-40 至 +85°C	6-引线, Super-SOT™6, JEDEC MO-193, 1.6mm 宽 (MA06A)
FAN5345S30X	30V		

典型应用图



图 1.典型应用

框图

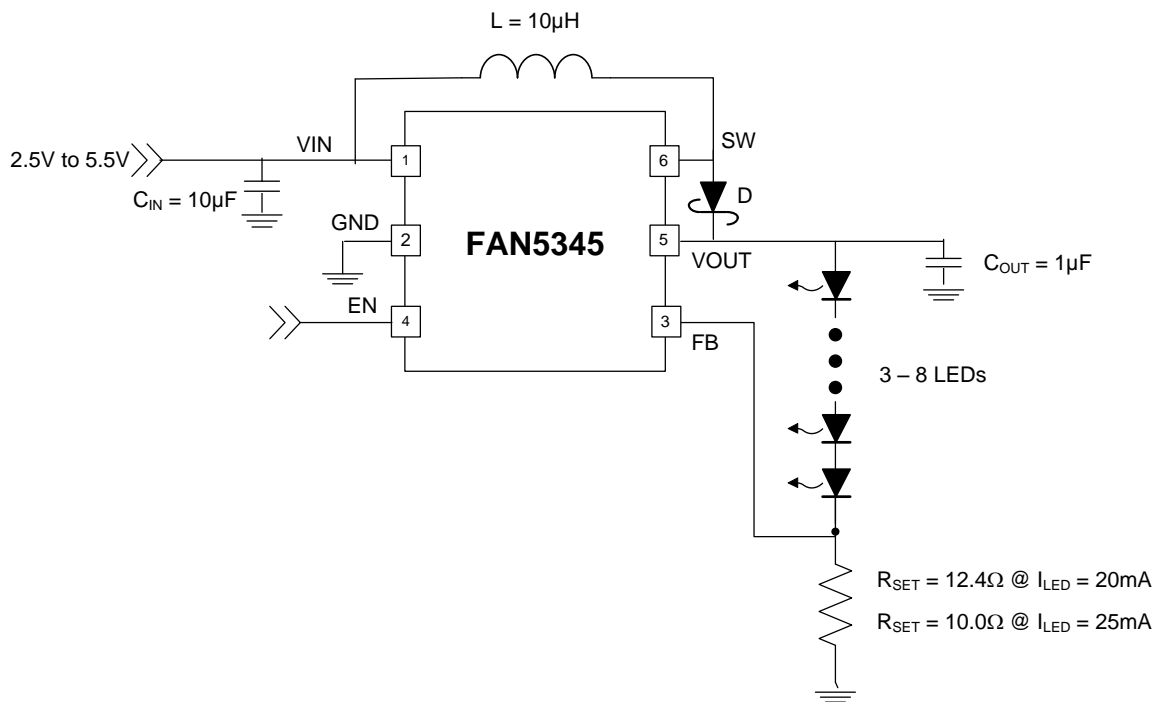

图 2.功能框图

引脚布局

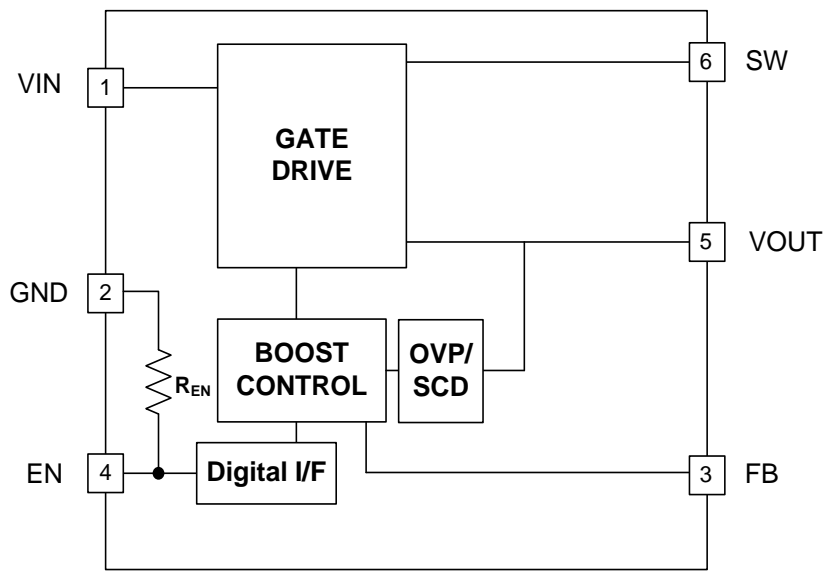

图 3.管脚分配俯视图

引脚说明

引脚号	名称	说明
5	VOUT	升压输出电压。 升压稳压器的输出。LED连接到该引脚。连接 C_{OUT} （输出电容）至GND。
1	VIN	输入电压。 接入电源，并连接退耦 C_{IN} 至地。
4	EN	启用亮度控制。 采用数字脉冲驱动该引脚可编制调光等级。
3	FB	电压反馈点。 升压稳压器可将该引脚的电压调至0.250V，以控制LED的串行电流。将该引脚连接GND和LED串阴极之间的电流设置电阻（ R_{SET} ）。
6	SW	开关节点。 在VIN管脚和SW管脚之间串联L1
2	GND	接地。 直接连至GND平面。

绝对最大额定值

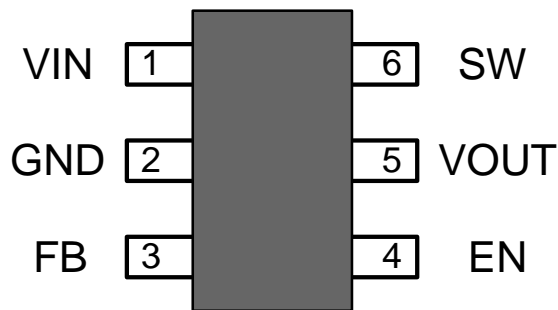
超过绝对最大额定值，会损坏器件。在推荐的工作条件之上，该器件可能无法正常运行或操作，因此不建议让器件在这些条件下长期工作。此外，过度暴露在高于推荐的工作条件下，会影响器件的可靠性。绝对最大额定值仅是极端额定值。

符号	参数	最小值	最大值	单位	
V_{IN}	VIN 引脚	-0.3	6.0	V	
V_{FB}, V_{EN}	FB、EN 引脚	-0.3	$V_{IN} + 0.3$	V	
V_{SW}	SW 引脚	FAN5345S20X	-0.3	22.0	V
		FAN5345X30X	-0.3	33.0	V
V_{OUT}	VOUT 引脚	FAN5345S20X	-0.3	22.0	V
		FAN5345X30X	-0.3	33.0	V
ESD	静电放电防护	人体模型满足 JESD22-A114	1.5		kV
		充电器件模型满足 JESD22-C101	1.5		
T_J	结温	-40	+150	°C	
T_{STG}	存储温度	-65	+150	°C	
T_L	引线焊接温度，10秒		+260	°C	

推荐工作条件

推荐的操作条件定义了实际器件的工作条件。在推荐的工作条件下器件能达到数据表中规格的最佳性能达到数据表中的规格。飞兆半导体建议不要超过推荐工作条件设计电路，更不能按照绝对最大额定值进行设计系统。

符号	参数	说明	最小值	最大值	单位
V_{IN}	V_{IN} 电源电压		2.5	5.5	V
V_{OUT}	V_{OUT} 电压 ⁽¹⁾	FAN5345S20X	6.2	18.5	V
		FAN5345S30X	6.2	28.5	
I_{OUT}	V_{OUT} 负载电流		5	25	mA
T_A	环境温度		-40	+85	°C
T_J	结温		-40	+125	°C

说明：

- 应用必须确保最大和最小占空比在20-85%之间，方可满足指定电压范围。

热性能

结-环境之间热阻与具体应用和电路板布局有关。该数据由2s2p四层板测得，符合 JESD51-JEDEC 标准。特别注意的是，不要超过给定环境温度 T_A 时的结温 $T_{J(max)}$ 。

符号	参数	典型值	单位
θ_{JA6}	结-环境之间热阻，SSOT23-6 封装	151	°C/W

电气规格

$V_{IN} = 2.5V$ 至 $5.5V$, $T_A = -40^{\circ}C$ 至 $+85^{\circ}C$, 除非另有说明。典型值测量条件为 $T_A = +25^{\circ}C$ 且 $V_{IN} = 3.6V$ 。

符号	参数	工作条件	最小值	典型值	最大值	单位
电源						
I_{SD}	待机电流	EN = GND		0.30	0.90	μA
$I_{Q(ACTIVE)}$	静态电流 $I_{LOAD} = 0mA$	器件未开关, 无负载		300		μA
V_{UVLO}	欠压闭锁阈值	V_{IN} 上升	2.10	2.35	2.60	V
		V_{IN} 下降	1.80	2.05	2.30	
V_{UVHYST}	欠压锁定迟滞电压			250		mV
EN: 启用引脚						
V_{IH}	输入电压高电平阈值		1.2			V
V_{IL}	输入电压低电平阈值				0.4	V
R_{EN}	EN 下拉电阻		200	300	400	$k\Omega$
T_{LO}	EN 低电平 调光时间 ⁽³⁾	$V_{IN} = 3.6V$; 图28	0.5		300	μs
T_{HI}	压差延时 ⁽³⁾	$V_{IN} = 3.6V$; ; 图28	0.5			μs
T_{SD}	EN 低电平, 关断脉冲宽度	$V_{IN} = 3.6V$; 自EN的下降沿			1	ms
反馈参考电压						
V_{FB}	反馈电压	$I_{LED} = 20mA$ $-40^{\circ}C$ 至 $+85^{\circ}C$, $2.7V \leq V_{IN} \leq 5.5V$	230	250	270	mV
I_{FB}	反馈输入电流	$V_{FB} = 250mV$		0.1	1.0	μA
电源输出						
$R_{DS(ON)_Q1}$	升压开关接通电阻	$V_{IN} = 3.6V, I_{SW} = 100mA$		600		m Ω
		$V_{IN} = 2.5V, I_{SW} = 100mA$		650		
$I_{SW(OFF)}$	SW 节点漏电流 ⁽²⁾	EN = 0, $V_{IN} = V_{SW} = V_{OUT} = 5.5V, V_{LED} = 0V$		0.1	2.0	μA
I_{LIM-PK}	升压开关峰值电流限值	FAN5345S20X: $V_{IN} = 3.2V$ 至 $4.3V, T_A = 20^{\circ}C$ 至 $+60^{\circ}C, V_F = 3.4V, 4 LEDs$	200	300	400	mA
		FAN5345S30X	500	750	1000	
振荡器						
f_{SW}	升压稳压器开关频率		0.95	1.15	1.35	MHz
输出和保护						
V_{OVP}	升压输出过压保护 (OVP)	FAN5345S20X	18.0	20.0	21.5	V
		FAN5345S30X	27.5	30.0	32.5	
	OVP 迟滞电压	FAN5345S20X		0.8		
		FAN5345S30X		1.0		
V_{TLSC}	V_{OUT} 短路检测阈值	V_{OUT} 下降		$V_{IN} - 1.4$		V
V_{THSC}	V_{OUT} 短路检测阈值	V_{OUT} 上升		$V_{IN} - 1.2$		V
D_{MAX}	最大升压占空比 ^(3,4)		85			%
D_{MIN}	最小升压占空比 ^(3,4)				20	
T_{TSD}	热关闭温度			150		$^{\circ}C$
T_{HYS}	热关闭迟滞温度			35		$^{\circ}C$

说明:

- SW 漏电流包括包括两个内部开关的漏电流; SW 至 GND 与 SW 至 V_{OUT} 。
- 量产未测试; 由设计保证。
- 应用必须确保最大和最小占空比在20-85%之间, 方可满足指定电压范围。

典型特性

$V_{IN} = 3.6V$, $T_A = 25^\circ C$, $I_{LED} = 25mA$, $L = 10\mu H$, $C_{OUT} = 1.0\mu F$, 且 $C_{IN} = 10.0\mu F$.



图 4.3 LED: 效率 vs LED 电流 vs. 输入电压



图 5.4 LED: 效率 vs LED 电流 vs. 输入电压

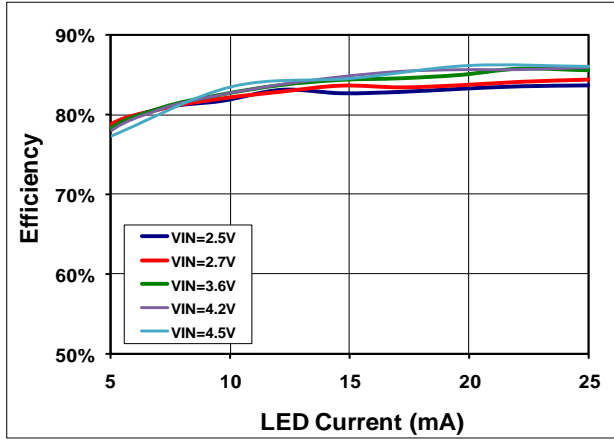

图 6.5 LED: 效率 vs LED 电流 vs. 输入电压

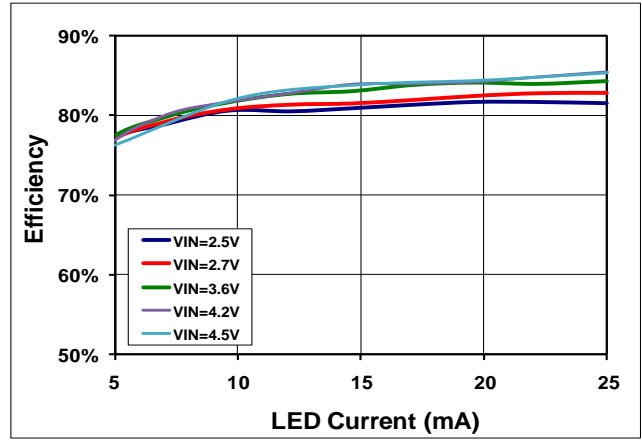

图 7.6 LED: 效率 vs LED 电流 vs. 输入电压

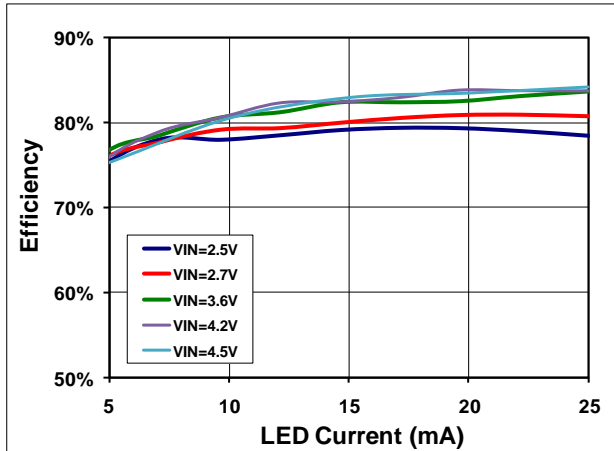

图 8.7 LED: 效率 vs LED 电流 vs. 输入电压

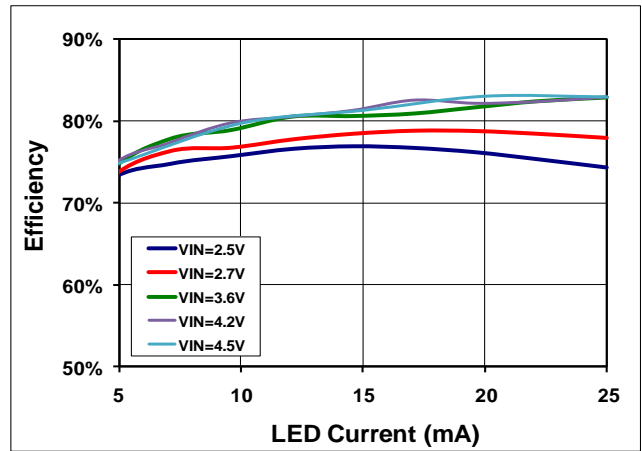

图 9.8 LED: 效率 vs LED 电流 vs. 输入电压

典型特性

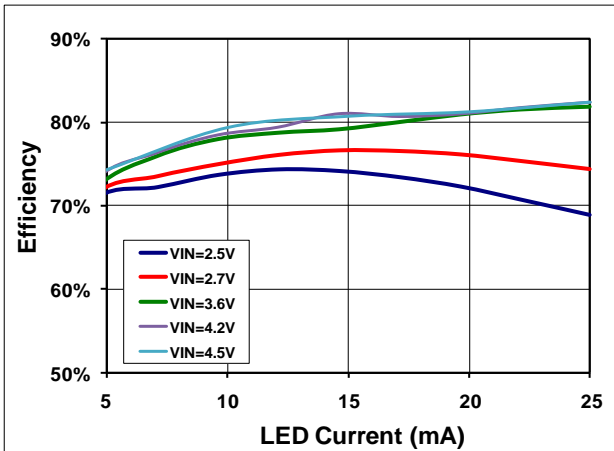
$V_{IN} = 3.6V$, $T_A = 25^\circ C$, $I_{LED} = 25mA$, $L = 10\mu H$, $C_{OUT} = 1.0\mu F$, 且 $C_{IN} = 10.0\mu F$.

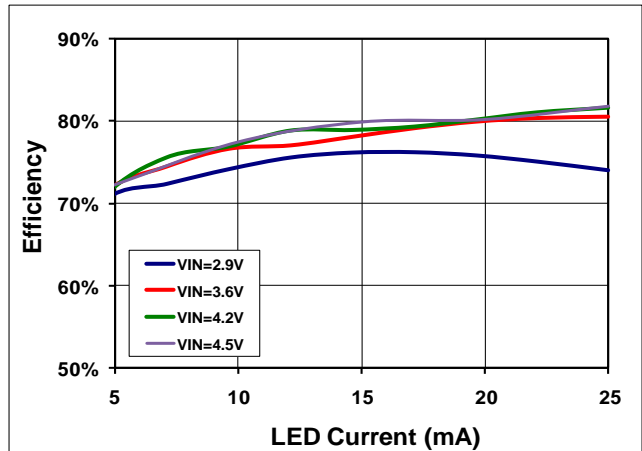

图 10.5 只串联LED时效率 vs. 输入电压 vs. 温度



图 11.7 只串联LED时效率 vs. 输入电压 vs. 温度

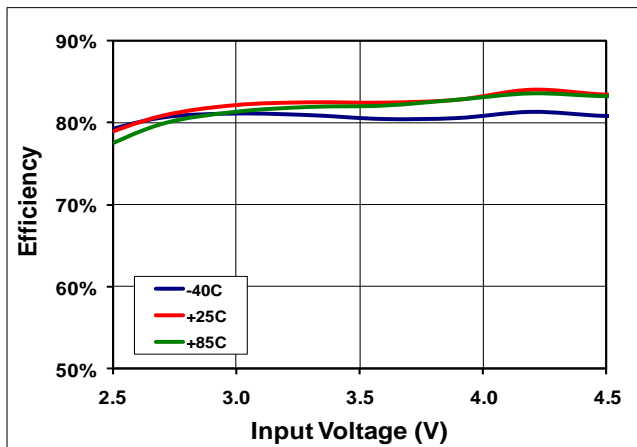

图 12. V_{FB} 随输入电压和温度的变化, 7 LED, $L=10\mu H$ 且 $C_{OUT}=1.0\mu F$

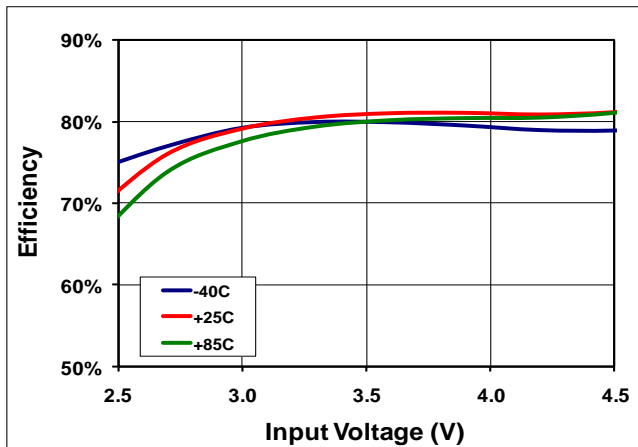

图 13. 频率 vs. 输入电压 vs. 温度

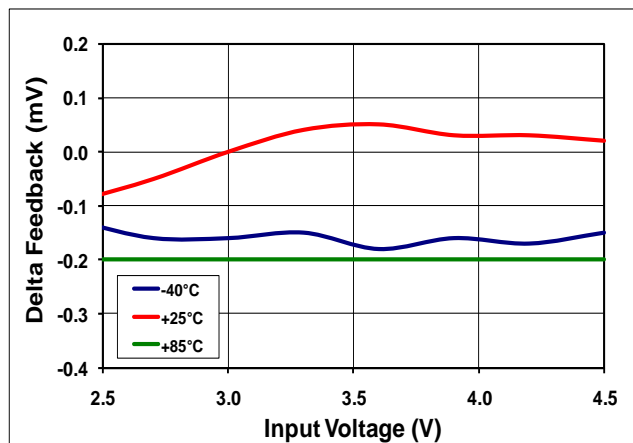

图 14. OVP vs. 输入电压: FAN5345S20X

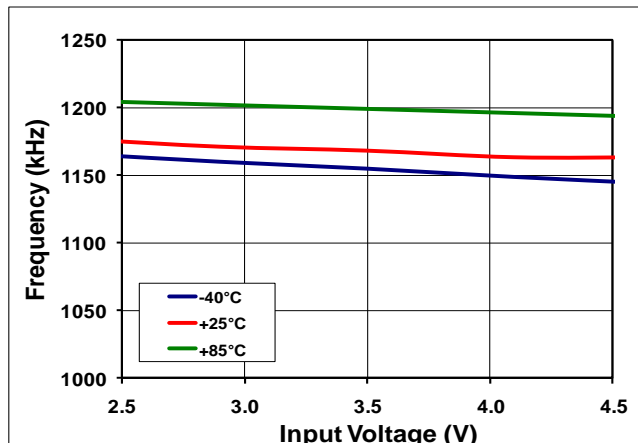

图 15. OVP vs. 输入电压: FAN5345S30X

典型特性

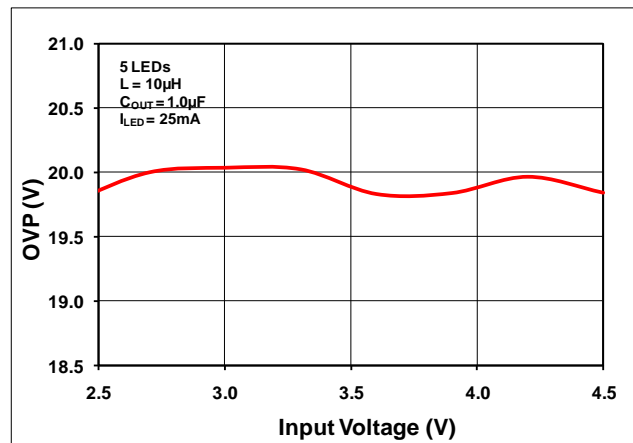
$V_{IN} = 3.6V$, $T_A = 25^\circ C$, $I_{LED} = 25mA$, $L = 10\mu H$, $C_{OUT} = 1.0\mu F$, 且 $C_{IN} = 10.0\mu F$.

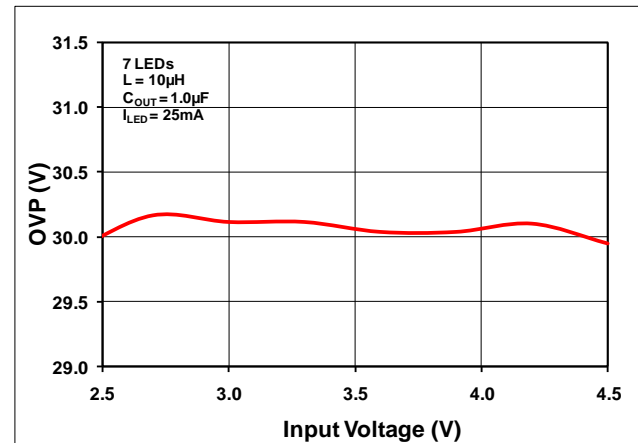

图 16. 待机电流 vs. 输入电压



图 17. 静态电流 vs. 输入电压

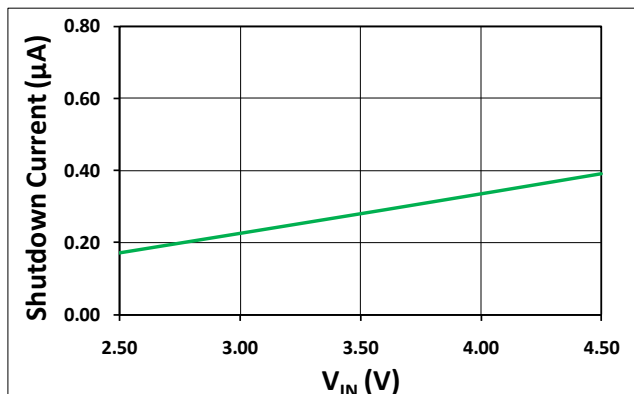

图 18. 调光操作

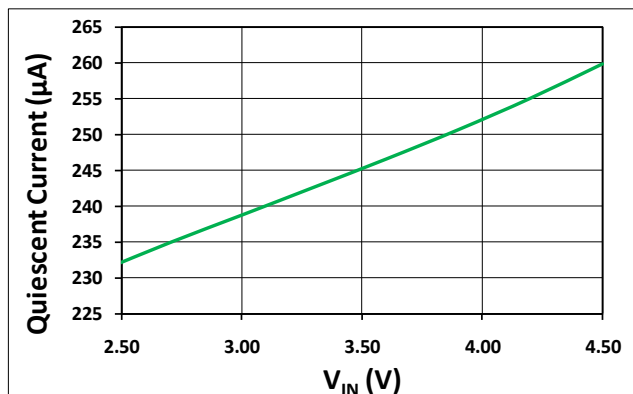

图 19. 5 LED 时的线性瞬态响应

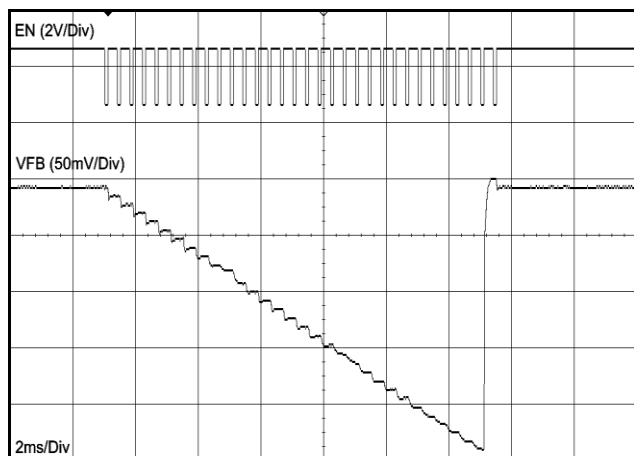

图 20. 6 LED 时的线性瞬态响应

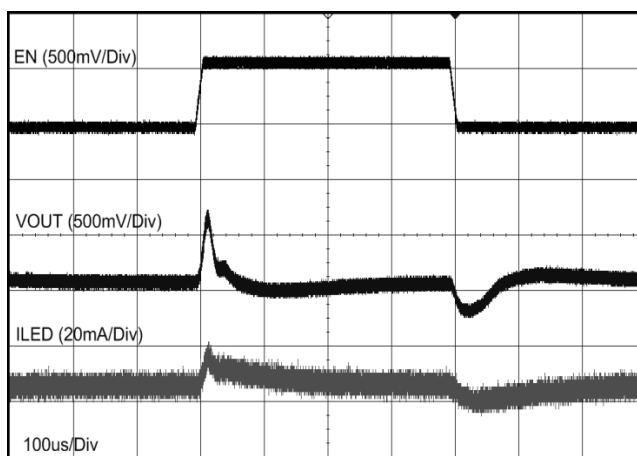

图 21. 7 LED 时的线性瞬态响应

典型特性

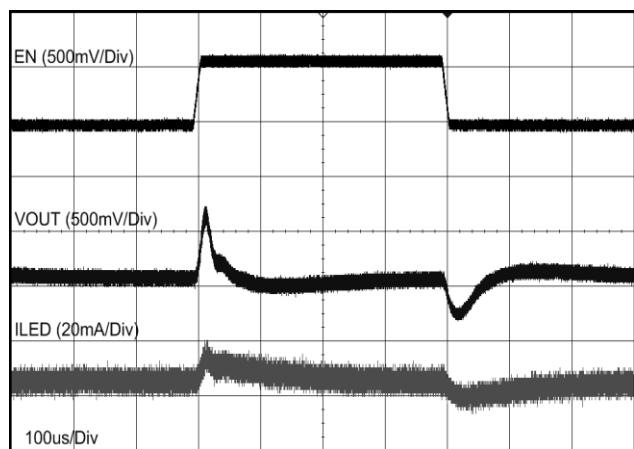
$V_{IN} = 3.6V$, $T_A = 25^\circ C$, $I_{LED} = 25mA$, $L = 10\mu H$, $C_{OUT} = 1.0\mu F$, 且 $C_{IN} = 10.0\mu F$.

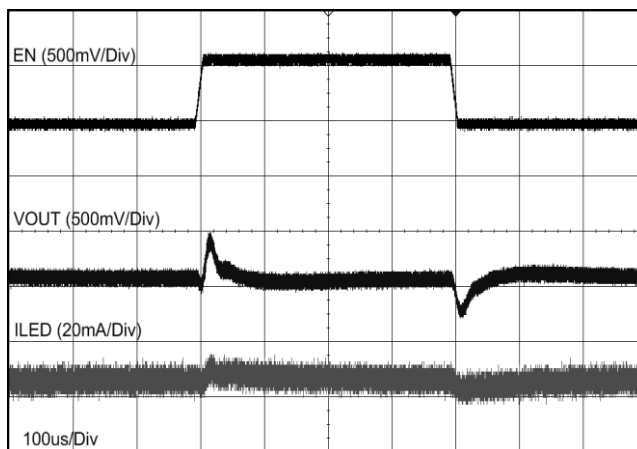

图 22.5 只LED时的开关电压、电感电流、 V_{FB} 及EN 的启动波形



图 23.5 LED的 V_{OUT} , 开关电压, 电感电流的稳态波形

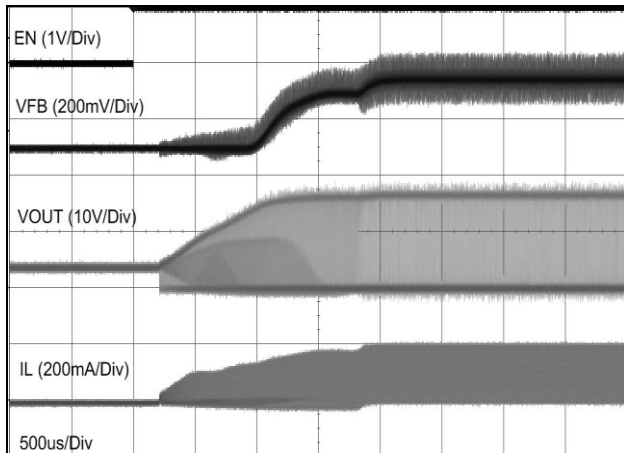

图 24.6 只LED时的开关电压、电感电流、 V_{FB} 及EN 的启动波形

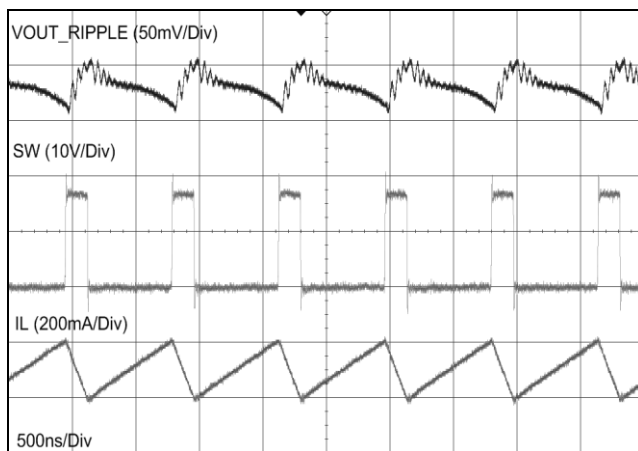

图 25.6 LED的 V_{OUT} , 开关电压, 电感电流的稳态波形

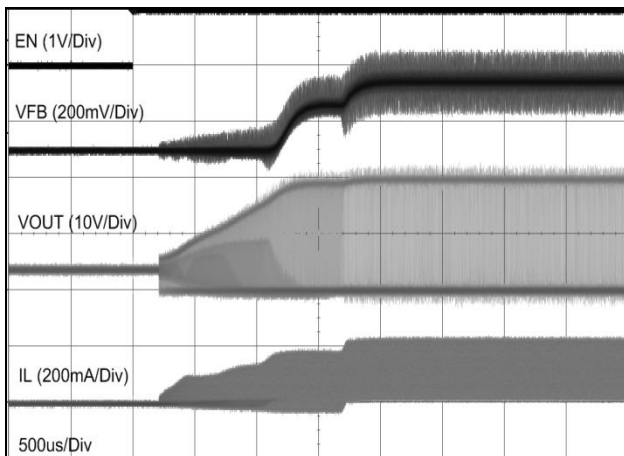

图 26.7 只LED时的开关电压、电感电流、 V_{FB} 及EN 的启动波形

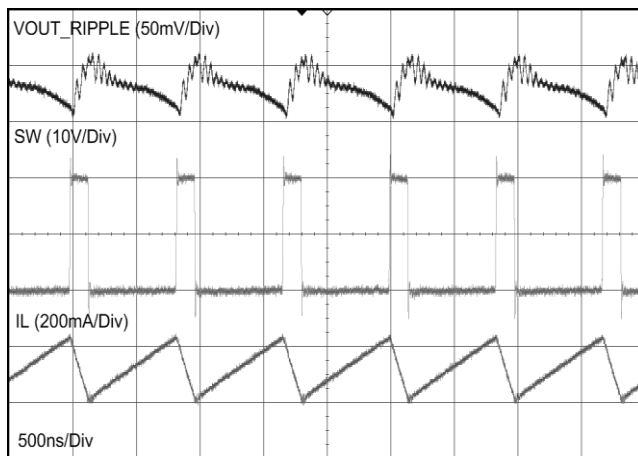

图 27.7 LED的 V_{OUT} , 开关电压, 电感电流的稳态波形

电路说明

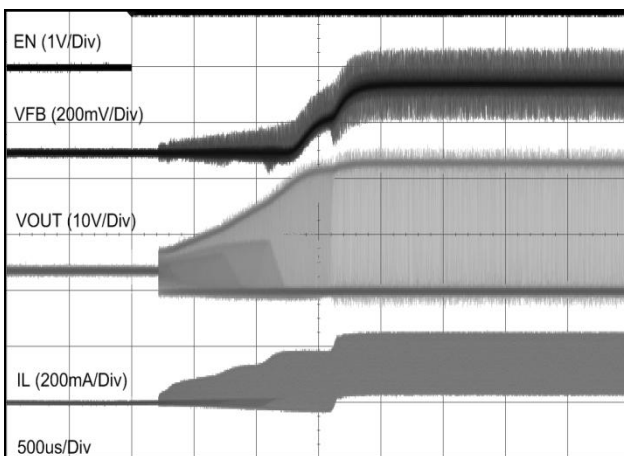
概述

FAN5345是一种感应电流模式升压串联LED驱动器，通过保持电阻 R_{SET} 端电压为0.250V，实现LED电流调节。LED串中的电流(I_{LED})的计算公式为：

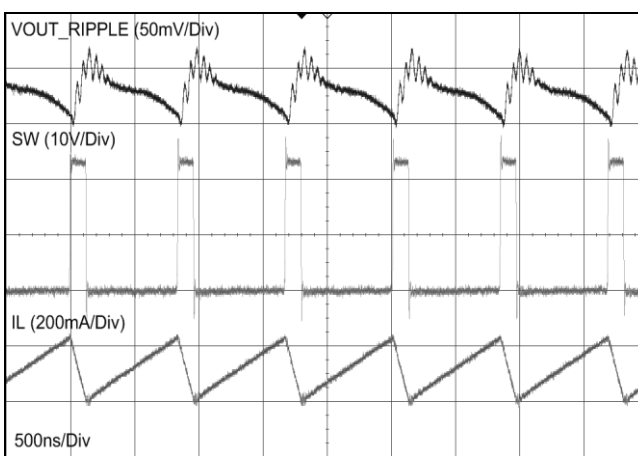
$$I_{LED} = \frac{0.250}{R_{SET}} \quad (1)$$

输出电压 V_{OUT} 取决于每只LED的正向电压与 R_{SET} 端电压之和， R_{SET} 端电压为恒值250mV。

UVLO 和软启动

假定 V_{IN} 大于UVLO阈值，如果EN处于低电平时间超过1ms，当EN上升时，IC开始“冷启动”软启动。

驱动八只串联LED

FAN5345S30X可以驱动8只串联LED，但是输入电压(V_{IN})的最小值必须大于或等于2.9V，而白色LED的正向电压应该小于或等于3.2V，同时为了维持稳态运行，LED的最大电流不能超过20mA。

数字接口

FAN5345使用单线数字接口编程控制LED亮度，具有32个线性等级。通过单线解决方案，FAN5345不需要系统处理器连续提供信号来驱动LED。

数字调光控制

FAN5345启动时驱动LED为最大亮度等级。启动后，控制逻辑可接受施加在EN管脚的编程脉冲的上升沿个数来逐步降低亮度。图28显示了FAN5345的数字脉冲的调光控制。软启动结束前，调光控制功能不起作用。软启动大约需要2ms。

过流和短路检测

对于FAN5345S20X 与FAN5345S30X，升压稳压器的周期性的电感电流峰值限制分别为300mA（典型值）与750mA（典型值）。

过压/开路保护

如果LED串开路，FB保持为0V，且当没有过压保护（OVP）电路时，输出电压持续增加。当输出电压 V_{OUT} 超过20.0V时，FAN5345S20X的过压保护（OVP）电路起动，保持稳压器升压调节关闭，直到 V_{OUT} 跌落低于19.0V为止。对于FAN5345S30X，过压保护值是30.0V，且当 V_{OUT} 低于29.0V时，该器件恢复正常状态。

热关闭

晶圆温度超过150°C时，发生复位并保持，直至晶圆冷却至115°C；此时允许电路开始软启动序列。



图 28.数字脉冲调光控制图

应用信息

参考原理图，图29。在输入电压大于等于2.9V ($V_{IN} \geq 2.9V$) 时，FAN5345可以驱动多达8只LED。但是，可以使用的LED数量取决于正向电压。建议白色LED的正向电压(V_F)不高于

3.2V，LED的最大电流为20mA。FAN5345可以用作升压变换器，应用时 V_{OUT} 端直接与负载相连同时负载的回线也应该通过检测电阻($R1$)返回到地。

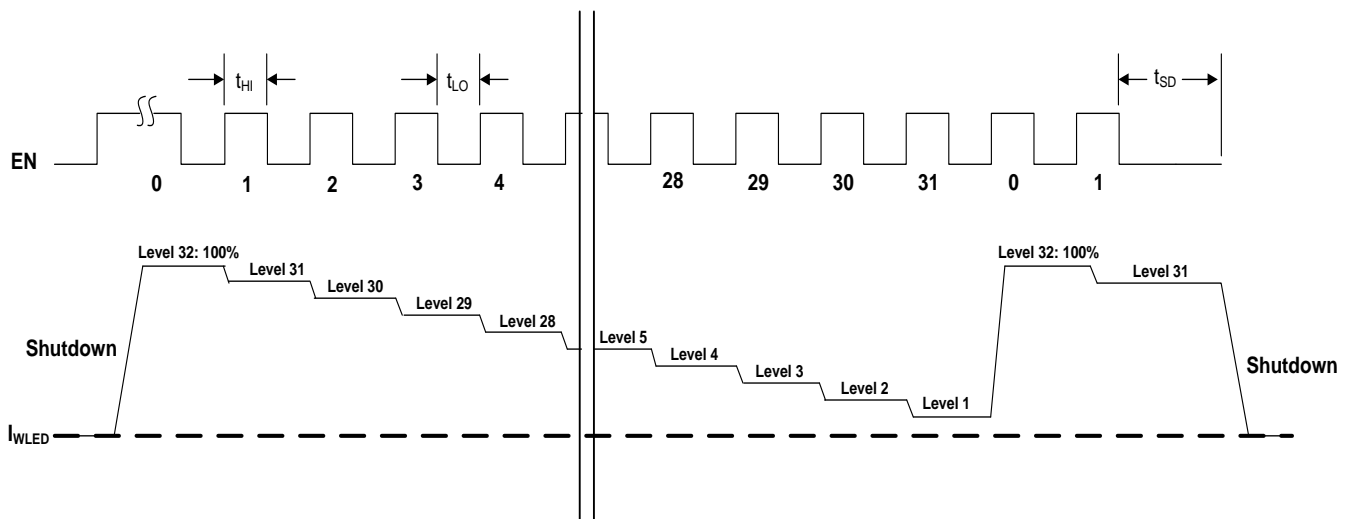

图 29. 参考应用原理图

推荐的器件和PCB布局

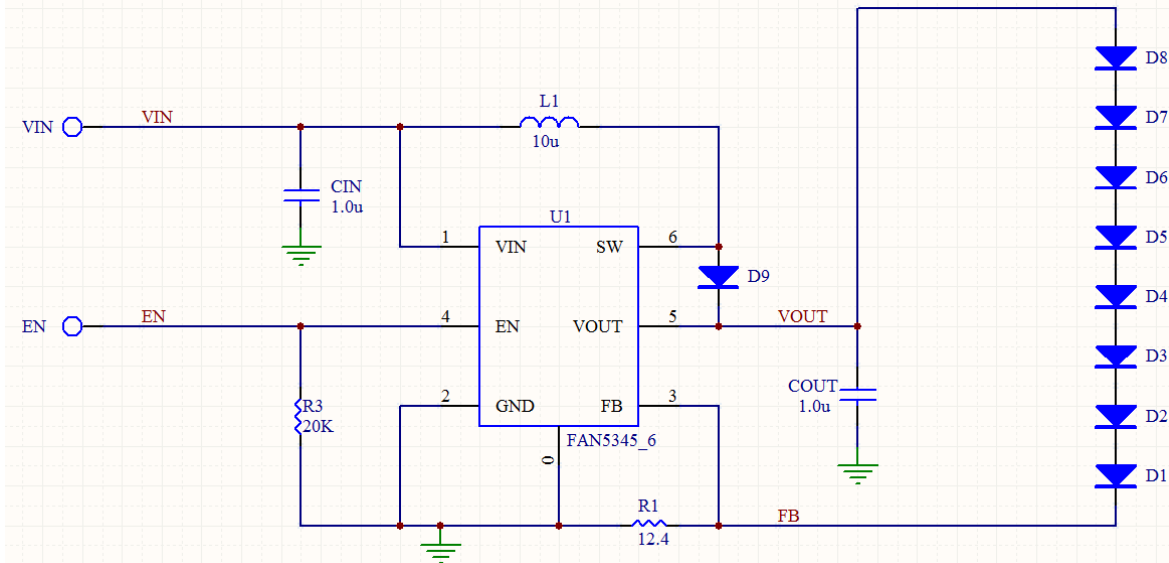

图 30. 参考用 PCB 布局

FAN5345可以升高输出电压，工作频率为1.2MHz。为了确保稳定输出并阻止噪声的产生，应当谨慎地考虑元器件的摆放与PCB布局。图30给出了FAN5345评估板的一部分。关键布局器件包括： $L1$ ， C_{IN} ， C_{IN} 回线， C_{OUT} ，以及 C_{OUT} 回线。

输入电容与回线

在buck或boost开关稳压器布局中，应优先考虑输入电容。一个稳定的输入电源 (V_{IN}) 可以使得开关型稳压器表现出最佳性能。稳压器运行时，其开关频率很高，输入电容为了使在同样开关频率下保持输入电源稳定， C_{IN} 上的负载会动态变化。为了确保稳定的输入电源， C_{IN} 需要保持足够的能量，才能最小化稳压器输入管脚的变化。为了使 C_{IN} 具有快速的充放电响应， C_{IN} 与稳压器输入管脚之间布线以及 C_{IN} 与稳压器GND之间的回线应该尽可能的粗短，以此来最小化布线电阻、电感与电容。在运行过程中，开关过程会导致由 C_{IN} 流出、流经稳压器后从负载流出、并流回 C_{IN} 的电流含有高频波动。由于 I^2R 损耗的缘故，布线电阻可以降低总效率。即使是很小布线电感也能有效地引起地电平的变化，给 V_{OUT} 带来噪声。应该将输入电容就近放置在稳压器的VIN与GND管脚旁，并且布线应该越短越好。由于过孔在高频时具有很强的电感效应，因此应该避免在不同层间布置回线。如果不可避免的要布线到其他的PCB层，那么过孔应紧靠稳压器的VIN与GND管脚，以此来最小化布线距离。

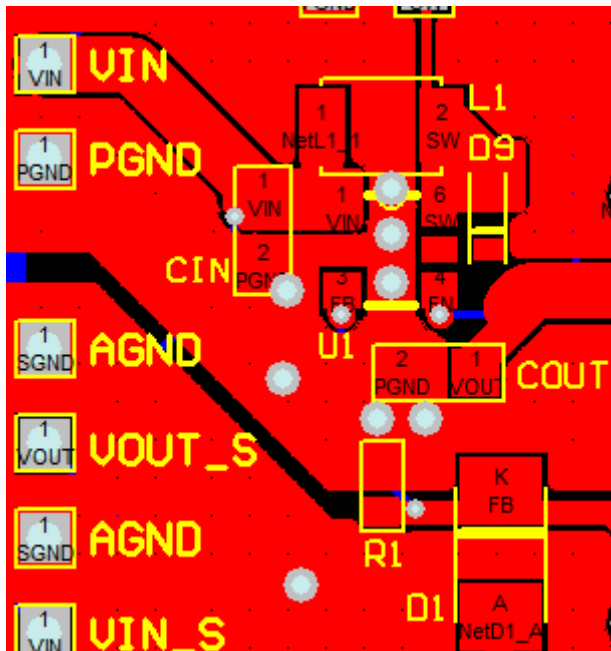
输出电容与回线

输出电容不仅与输入电容具有相同的作用，而且也能保证输出电压稳定。如上所述，电流流向负载并返回到 C_{OUT} 的GND端。 C_{OUT} 应该就近放置在VOUT管脚处。 C_{OUT} 到 $L1$ 、VOUT间的布线以及由负载到 C_{OUT} 间的回线应尽可能的短粗，以此来最小化布线电阻与电感。为了最小化负载的耦合噪声，可以在VOUT与 C_{OUT} 间放置一低容值电容，这样，高频噪声在到达负载前即可回到地中。

电感

根据以上原因，电感（L1）应该尽可能近地放置在稳压器附近，以此来最小化布线电阻与电感。

检测电阻

根据检测电阻提供的反馈信号，使稳压器控制输出电压。检测电阻到FB管脚的长布线向FB管脚耦合了噪声。如果FB管脚耦合了噪声，那么将会引起开关稳压器的不稳定运行，进而影响

应用性能。检测电阻到FB引脚的回线应该简短，且远离一切高频开关信号线。有必要将地平面放置在回路之下。如果回路下的地平面有噪声，但是与稳压器的地平面不同，该噪声就会通过PCB寄生电容耦合到FB管脚，产生噪声输出。

在图30中， C_{IN} 、 C_{OUT} 与L1均靠近稳压器放置。所有的布线都放在同一层，可以减小地平面电阻、电感。整个PCB面积为 67.2mm^2 (7.47mm x 8.99mm)，其中不包括检测电阻。

表 1. 建议使用的外部器件

	器件型号	生产厂商
电感 (L)		
10.0 μ H	LQH43MN100K03	Murata
	NLCV32T-100K-PFR	TDK
	VL3010AT-100MR49-1	TDK
	DEM2810C 1224-AS-H-100M	TOKO
最小 C_{OUT}		
1.0 μ F	CV105X5R105K25AT	AVX/Kyocera
最小 C_{IN}		
10 μ F	GRM21BR71A106KE51L	Murata
肖特基二极管		
N/A	RBS520S30	Fairchild Semiconductor
N/A	RB520S-30	Rohm

物理尺寸



图 31.6 引脚 SuperSOT™6, JEDEC MO-193, 1.6mm 宽

封装图纸是作为一项服务，提供给考虑飞兆半导体产品的客户。具体参数可进行改动，且无需做出相应通知。请注意图纸上的版本和/或日期，并联系飞兆半导体代表核实或获得最新版本。封装规格并不超出飞兆公司全球范围内的条款与条件，尤其指保修，保修涉及飞兆半导体的全部产品。

随时访问飞兆半导体在线封装网页，可以获得最新的封装图：

<http://www.fairchildsemi.com/packaging/>

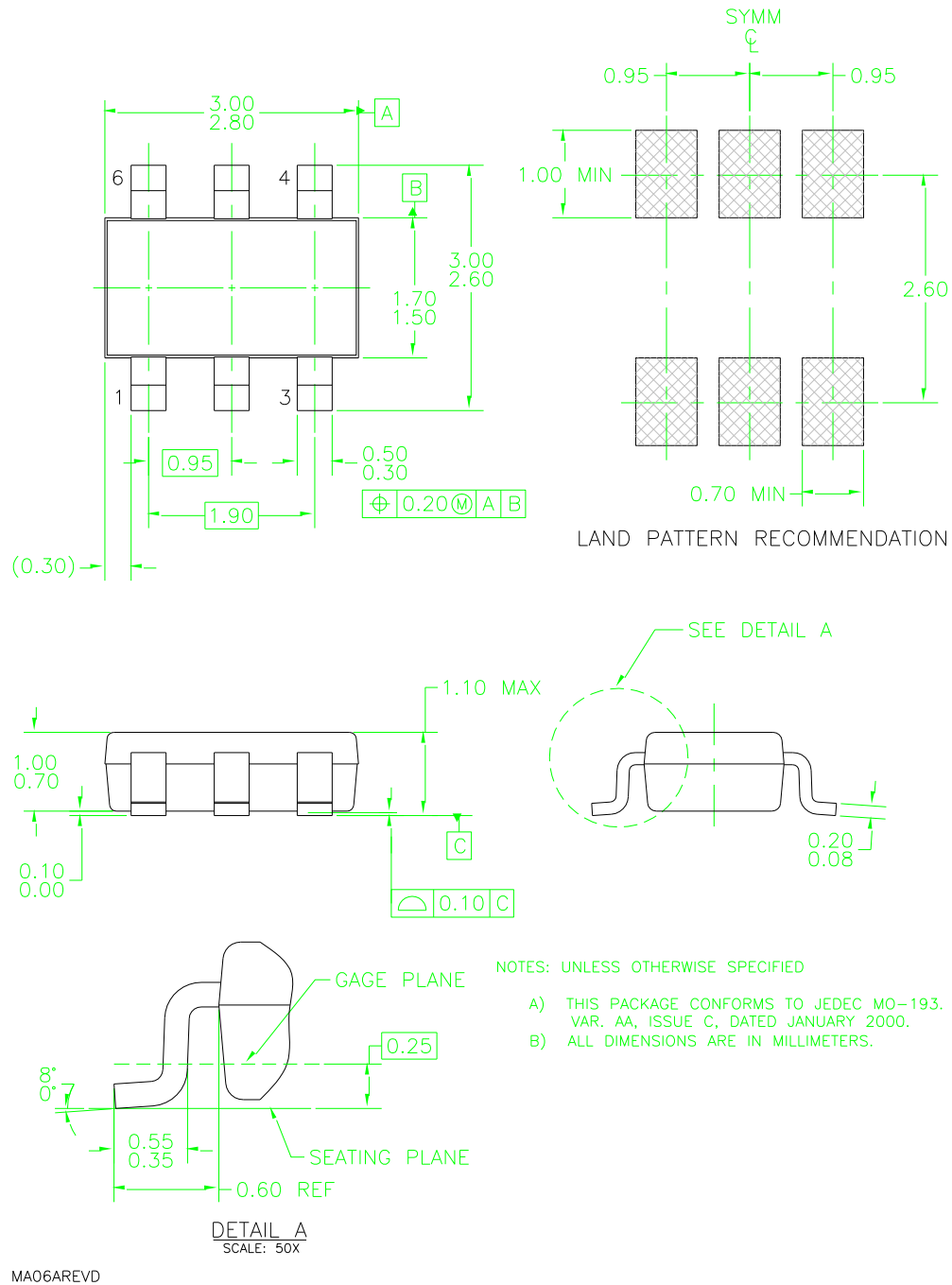

TRADEMARKS

The following includes registered and unregistered trademarks and service marks, owned by Fairchild Semiconductor and/or its global subsidiaries, and is not intended to be an exhaustive list of all such trademarks.

- | | | | |
|--------------------------|--|---------------------------------------|------------------|
| 2Cool™ | FPS™ | PowerTrench® | Sync-Lock™ |
| AccuPower™ | F-PFST™ | PowerXS™ | SYSTEM GENERAL® |
| AX-CAP® | FRFET® | Programmable Active Droop™ | TinyBoost™ |
| BitSiC™ | Global Power Resource™ | QFET® | TinyBuck™ |
| Build it Now™ | GreenBridge™ | QST™ | TinyCalc™ |
| CorePLUS™ | Green FPS™ | Quiet Series™ | TinyLogic® |
| CorePOWER™ | Green FPS™ e-Series™ | RapidConfigure™ | TINYOPTO™ |
| CROSSVOLT™ | Gmax™ | Saving our world, 1mW/Wk/W at a time™ | TinyPower™ |
| CTL™ | GTO™ | SignalWise™ | TinyPWM™ |
| Current Transfer Logic™ | IntelliMAX™ | SmartMax™ | TinyWire™ |
| DEUXPEED® | ISOPLANAR™ | SMART START™ | TranSiC™ |
| Dual Cool™ | Making Small Speakers Sound Louder and Better™ | Solutions for Your Success™ | TriFault Detect™ |
| EcoSPARK® | MegaBuck™ | SPM® | TRUECURRENT® |
| EfficientMax™ | MICROCOUPLER™ | STEALTH™ | µSerDes™ |
| ESBC™ | MicroFET™ | SuperFET® | UHC® |
| F ® | MicroPak™ | SuperSOT™-3 | Ultra FRFET™ |
| Fairchild® | MicroPak2™ | SuperSOT™-6 | UniFET™ |
| Fairchild Semiconductor® | MillerDrive™ | SuperSOT™-8 | VCX™ |
| FACT Quiet Series™ | MotionMax™ | SupreMOS® | VisualMax™ |
| FACT® | mWSaver™ | SyncFET™ | VoltagePlus™ |
| FAST® | OptoHiT™ | | XS™ |
| FastvCore™ | OPTOLOGIC® | | |
| FETBench™ | OPTOPLANAR® | | |

* Trademarks of System General Corporation, used under license by Fairchild Semiconductor.

DISCLAIMER

FAIRCHILD SEMICONDUCTOR RESERVES THE RIGHT TO MAKE CHANGES WITHOUT FURTHER NOTICE TO ANY PRODUCTS HEREIN TO IMPROVE RELIABILITY, FUNCTION, OR DESIGN. FAIRCHILD DOES NOT ASSUME ANY LIABILITY ARISING OUT OF THE APPLICATION OR USE OF ANY PRODUCT OR CIRCUIT DESCRIBED HEREIN; NEITHER DOES IT CONVEY ANY LICENSE UNDER ITS PATENT RIGHTS, NOR THE RIGHTS OF OTHERS. THESE SPECIFICATIONS DO NOT EXPAND THE TERMS OF FAIRCHILD'S WORLDWIDE TERMS AND CONDITIONS, SPECIFICALLY THE WARRANTY THEREIN, WHICH COVERS THESE PRODUCTS.

LIFE SUPPORT POLICY

FAIRCHILD'S PRODUCTS ARE NOT AUTHORIZED FOR USE AS CRITICAL COMPONENTS IN LIFE SUPPORT DEVICES OR SYSTEMS WITHOUT THE EXPRESS WRITTEN APPROVAL OF FAIRCHILD SEMICONDUCTOR CORPORATION.

As used herein:

1. Life support devices or systems are devices or systems which, (a) are intended for surgical implant into the body or (b) support or sustain life, and (c) whose failure to perform when properly used in accordance with instructions for use provided in the labeling, can be reasonably expected to result in a significant injury of the user.
2. A critical component in any component of a life support, device, or system whose failure to perform can be reasonably expected to cause the failure of the life support device or system, or to affect its safety or effectiveness.

ANTI-COUNTERFEITING POLICY

Fairchild Semiconductor Corporation's Anti-Counterfeiting Policy. Fairchild's Anti-Counterfeiting Policy is also stated on our external website, www.fairchildsemi.com, under Sales Support.

Counterfeiting of semiconductor parts is a growing problem in the industry. All manufacturers of semiconductor products are experiencing counterfeiting of their parts. Customers who inadvertently purchase counterfeit parts experience many problems such as loss of brand reputation, substandard performance, failed applications, and increased cost of production and manufacturing delays. Fairchild is taking strong measures to protect ourselves and our customers from the proliferation of counterfeit parts. Fairchild strongly encourages customers to purchase Fairchild parts either directly from Fairchild or from Authorized Fairchild Distributors who are listed by country on our web page cited above. Products customers buy either from Fairchild directly or from Authorized Fairchild Distributors are genuine parts, have full traceability, meet Fairchild's quality standards for handling and storage and provide access to Fairchild's full range of up-to-date technical and product information. Fairchild and our Authorized Distributors will stand behind all warranties and will appropriately address any warranty issues that may arise. Fairchild will not provide any warranty coverage or other assistance for parts bought from Unauthorized Sources. Fairchild is committed to combat this global problem and encourage our customers to do their part in stopping this practice by buying direct or from authorized distributors.

PRODUCT STATUS DEFINITIONS

Definition of Terms

Datasheet Identification	Product Status	Definition
Advance Information	Formative / In Design	Datasheet contains the design specifications for product development. Specifications may change in any manner without notice.
Preliminary	First Production	Datasheet contains preliminary data; supplementary data will be published at a later date. Fairchild Semiconductor reserves the right to make changes at any time without notice to improve design.
No Identification Needed	Full Production	Datasheet contains final specifications. Fairchild Semiconductor reserves the right to make changes at any time without notice to improve the design.
Obsolete	Not In Production	Datasheet contains specifications on a product that is discontinued by Fairchild Semiconductor. The datasheet is for reference information only.

Rev. 164

ON Semiconductor and  are trademarks of Semiconductor Components Industries, LLC dba ON Semiconductor or its subsidiaries in the United States and/or other countries. ON Semiconductor owns the rights to a number of patents, trademarks, copyrights, trade secrets, and other intellectual property. A listing of ON Semiconductor's product/patent coverage may be accessed at www.onsemi.com/site/pdf/Patent-Marking.pdf. ON Semiconductor reserves the right to make changes without further notice to any products herein. ON Semiconductor makes no warranty, representation or guarantee regarding the suitability of its products for any particular purpose, nor does ON Semiconductor assume any liability arising out of the application or use of any product or circuit, and specifically disclaims any and all liability, including without limitation special, consequential or incidental damages. Buyer is responsible for its products and applications using ON Semiconductor products, including compliance with all laws, regulations and safety requirements or standards, regardless of any support or applications information provided by ON Semiconductor. "Typical" parameters which may be provided in ON Semiconductor data sheets and/or specifications can and do vary in different applications and actual performance may vary over time. All operating parameters, including "Typicals" must be validated for each customer application by customer's technical experts. ON Semiconductor does not convey any license under its patent rights nor the rights of others. ON Semiconductor products are not designed, intended, or authorized for use as a critical component in life support systems or any FDA Class 3 medical devices or medical devices with a same or similar classification in a foreign jurisdiction or any devices intended for implantation in the human body. Should Buyer purchase or use ON Semiconductor products for any such unintended or unauthorized application, Buyer shall indemnify and hold ON Semiconductor and its officers, employees, subsidiaries, affiliates, and distributors harmless against all claims, costs, damages, and expenses, and reasonable attorney fees arising out of, directly or indirectly, any claim of personal injury or death associated with such unintended or unauthorized use, even if such claim alleges that ON Semiconductor was negligent regarding the design or manufacture of the part. ON Semiconductor is an Equal Opportunity/Affirmative Action Employer. This literature is subject to all applicable copyright laws and is not for resale in any manner.

PUBLICATION ORDERING INFORMATION

LITERATURE FULFILLMENT:

Literature Distribution Center for ON Semiconductor
19521 E. 32nd Pkwy, Aurora, Colorado 80011 USA
Phone: 303-675-2175 or 800-344-3860 Toll Free USA/Canada
Fax: 303-675-2176 or 800-344-3867 Toll Free USA/Canada
Email: orderlit@onsemi.com

N. American Technical Support: 800-282-9855 Toll Free
USA/Canada
Europe, Middle East and Africa Technical Support:
Phone: 421 33 790 2910
Japan Customer Focus Center
Phone: 81-3-5817-1050

ON Semiconductor Website: www.onsemi.com
Order Literature: <http://www.onsemi.com/orderlit>
For additional information, please contact your local
Sales Representative