

 ELECTRONICS

# METRAL<sup>®</sup>

## 2 mm Modular Interconnect System

# TABLE OF CONTENTS

<b>General information</b>				3
<b>Catalog Main set up</b>				4
<b>METRAL® core product selector</b>	most popular METRAL® connector selector			5
<b>Product finder</b>	all products			9
<b>Application selector</b>	various applications examples			18
<b>Signal connectors standard</b>	header	straight	4 row - wide body	24
	header	straight	4 row - narrow body	28
	receptacle	right angle	4 row	32
	header	straight	5 row - wide body	40
	receptacle	right angle	5 row	42
	header	straight	8 row - wide body	48
	receptacle	right angle	8 row	50
<b>Signal connectors reversed</b>	header	right angle	4 row - wide body	54
	header	right angle	4 row - narrow body	60
	receptacle	straight	4 row	66
	header	right angle	5 row - wide body	70
	receptacle	straight	5 row	76
<b>Shrouds</b>	4 row - wide body			82
	5 row - wide body			84
	8 row - wide body			86
<b>Power connectors standard</b>	header	straight	4 row - wide body	90
	header	straight	4 row - narrow body	94
	receptacle	right angle	4 row	98
	header	straight	5 row - wide body	104
	receptacle	right angle	5 row	108
<b>Power connectors reversed</b>	header	right angle	4 row - wide body	110
	receptacle	straight	4 row	122
	header	right angle	5 row - wide body	124
	receptacle	straight	5 row	130
<b>Electrical enhanced</b>	header	straight	5 row	134
	shroud		5 row (5+2 row)	136
	receptacle	right angle	5 row	138
<b>Shielded connectors</b>	header	straight	5 row	142
	round cable connector		5 row	144
<b>High power connector</b>	high power header			148
	high power receptacle			150
<b>Hybrid connectors</b>	DIN standard high power			154
	Mini power			158
	DIN standard coax			162
	Mini coax			166
<b>Cable connectors</b>	signal			172
	shielded			176
<b>Accessories</b>	coding keys			180
	cable connector coding keys			182
	guide pin			184
	board-to-board keying system			186
	ramping module			188
	shorting clip			190
	end wall			194
	hybrid housing			196
<b>Application specific</b>	monoblocks			200
	customized designs			200
<b>Technical specification</b>	Futurebus			204
	IPCI Bus			205
	electrical specs			206
<b>PCB- lay out</b>	pcb lay out recommendations			208
<b>Application equipment</b>				217
<b>Part number index</b>				224

## FCI: SETTING THE STANDARD FOR CONNECTORS

With operations in 30 countries, FCI is a leading manufacturer of connectors. Our 13,500 employees are committed to providing customers with high-quality, innovative products for a wide range of consumer and industrial applications.



### GENERAL INFORMATION

- The METRAL® connector range is the standard 2 mm board-to-board and cable-to-board interconnect system designed in accordance with IEC 61076-4-104 and Telcordia® GR-1217-CORE.
- Connector system used for chassis based packaging in the communications, data, medical and Industrial and Instrumentation segments.
- The METRAL® connector system is applicable for low speed and high speed transmission and switching equipment. Signals from 2 up to 5 Gbp/s used in backplanes, mid-planes, extension cards, power (3 up to 60 amps) and I/O applications.
- The Catalog presents the full range of METRAL® connectors, signal, (high) power, shielded, cable and hybrid connectors, all with various choices in dimensions, features and options.
- For a quick solution you can select one of the products out of the METRAL® core product selector, a selection of the most popular products out of the METRAL® family range. (see page 5 to 7)

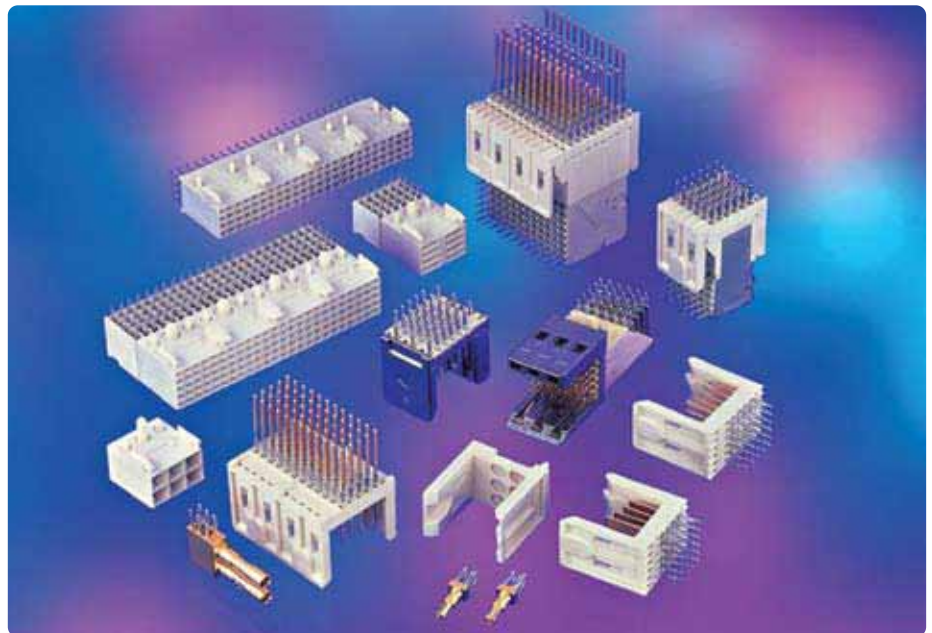

#### LIABILITY

We believe that the information contained in this publication is the best currently available on the subject. It is offered as a possible helpful suggestion in any experimentation you may care to undertake and is subject to revision as additional knowledge and experience is gained. FCI makes no guarantee of results and assumes no obligation or liability whatsoever in connection with this information. This publication is not a license to operate under, or intended to suggest infringement of, any existing patent. Information given on the drawings in this document is not suitable for tooling design and construction. To obtain the correct drawings for these purposes, contact your local FCI representative.

## Catalog Main set-up

### STANDARD CONNECTION

- Straight Header on backplane / motherboard
- Right Angle Receptacle on the daughter card
- Additional choices, 4 or 5 row and signal or power

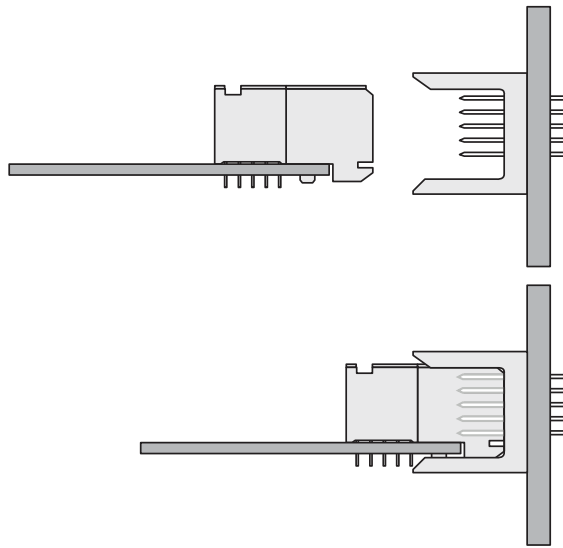

### REVERSED CONNECTION

- Straight Receptacle on backplane / motherboard
- Right Angle Header on the daughter card
- Additional choices, 4 or 5 row and signal or power

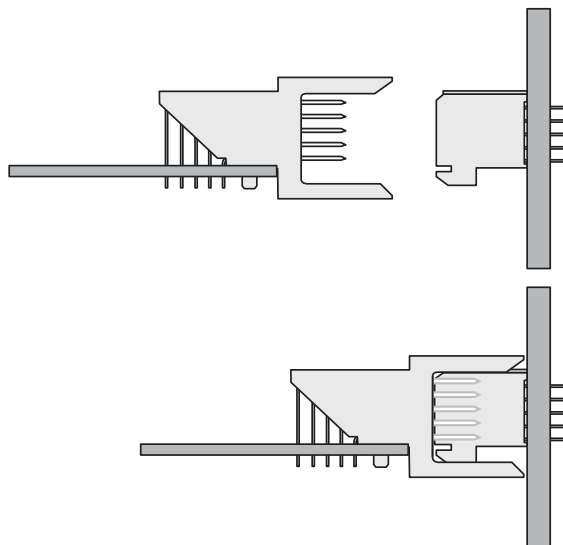

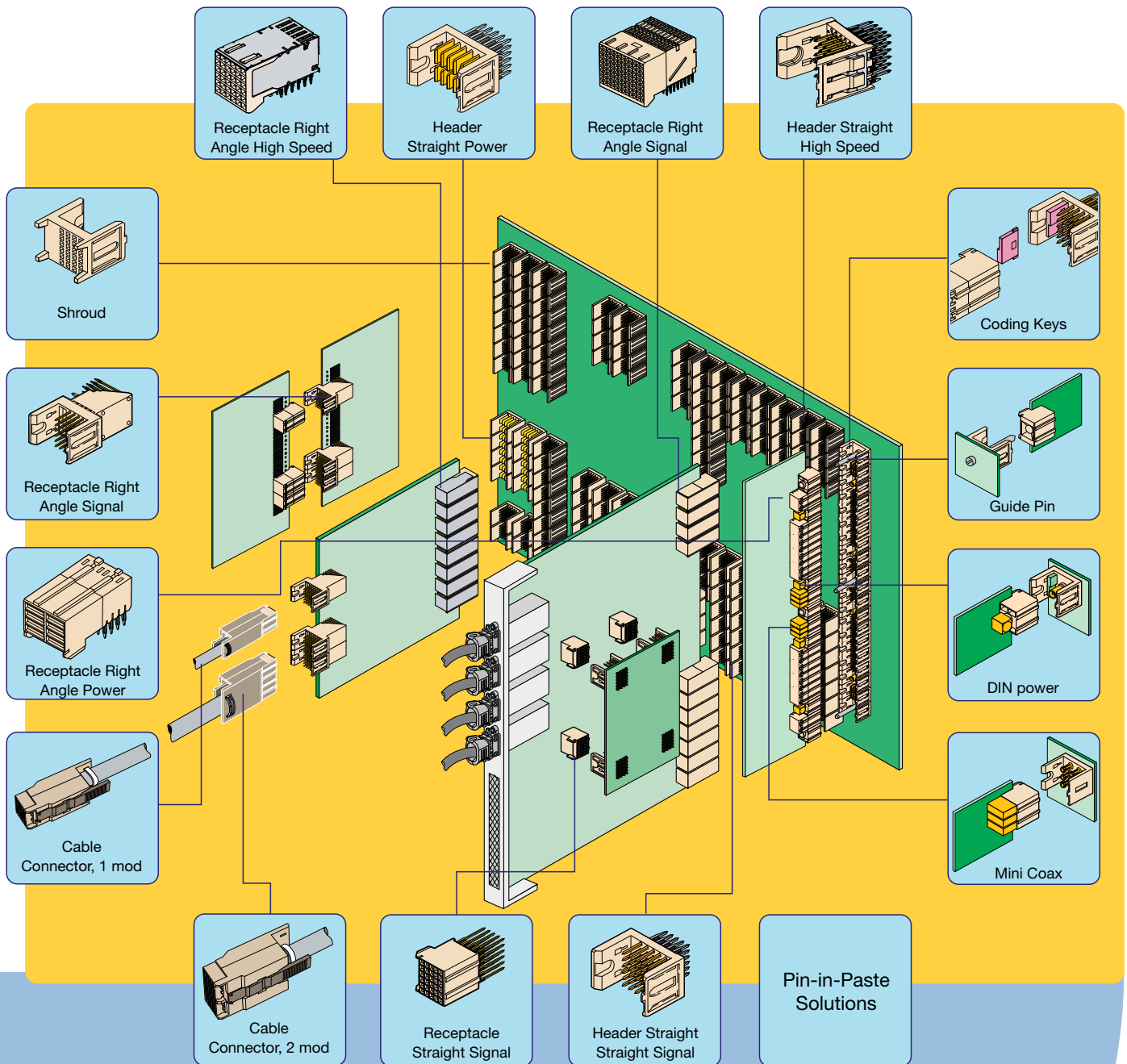

## METRAL® Core Product Selector

Selection of the most popular connectors out of the METRAL® family



Signal Standard

Receptacle, Right angle, Signal

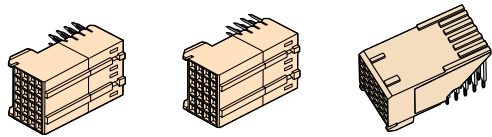

press-fit      solder to board      pin in paste

Press Fit			
Module	4 row	5 row	8 row
1	88945-102LF	89047-102LF	-
2	88946-102LF	89093-102LF	74770-102LF
4	88947-102LF	89094-102LF	-
8	88948-102LF	89095-102LF	-
Solder to Board			
1	89035-102LF	85863-102LF	
2	89036-102LF	85864-102LF	
4	89037-102LF	85865-102LF	
8	89038-102LF	85866-102LF	
Pin in Paste			
1	52048-101LF	52049-101LF	

Header, Straight, Signal

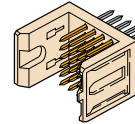

Press Fit, Wide body			
Module	4 row	5 row	8 row
1	70232-116LF	89006-116LF	-
2	70233-116LF	89007-116LF	74771-102011LF
4	70234-116LF	89008-116LF	-
8	70235-116LF	89009-116LF	-

Shroud

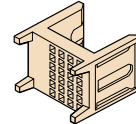

Wide body			
Module	4 row	5 row	8 row
1	70203-111LF	89055-111LF	-
2	70203-112LF	89055-112LF	98173-102LF
4	70203-113LF	89055-113LF	-
8	70203-114LF	89055-114LF	-

Signal Reversed

Receptacle, Straight, Signal



press-fit      solder to board

Press Fit		
Module	4 row	5 row
1	85757-1101LF	85761-1101LF
2	85758-1101LF	-
4	85759-1101LF	85763-1101LF
8	85760-1101LF	-
Solder to Board		
1	HM1S41FRR000H6PLF	HM1S51FRR000H6PLF
2	HM1S42FRR000H6PLF	HM1S52FRR000H6PLF
4	HM1S43FRR000H6PLF	HM1S53FRR000H6PLF
8	HM1S44FRR000H6PLF	HM1S54FRR000H6PLF

Header, Right angle, Signal

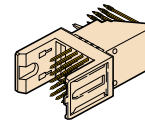

Press Fit Wide Body		
Module	4 row	5 row
1	HM1L41LDP000H6PLF	HM1L51LDP000H6PLF
2	HM1L42LDP000H6PLF	HM1L52LDP000H6PLF
4	HM1L43LDP000H6PLF	HM1L53LDP000H6PLF
8	HM1L44LDP000H6PLF	HM1L54LDP000H6PLF
Solder to Board Wide Body		
1	HM1L41LAP000H6PLF	HM1L51LAP000H6PLF
2	HM1L42LAP000H6PLF	HM1L52LAP000H6PLF
4	HM1L43LAP000H6PLF	HM1L53LAP000H6PLF
8	HM1L44LAP000H6PLF	HM1L54LAP000H6PLF
Pin in Paste Wide Body		
1	HM1L41LFP000H6PLF	HM1L51LFP000H6PLF

Power Standard

Receptacle, Right angle, Power

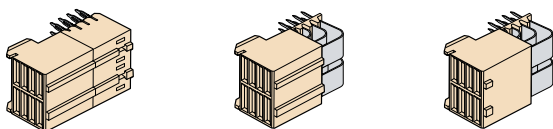

press-fit      solder to board      pin in paste

Press Fit		
Module	4 row	5 row
1	88949-102LF	89096-102LF
Solder to Board		
1	89039-101LF	85876-102LF
Pin in Paste		
1	72651-101LF	63793-101LF

Header, Straight, Power

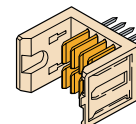

Press Fit, Wide Body		
Module	4 row	5 row
1	70236-101LF	89099-111LF

Guide Pin

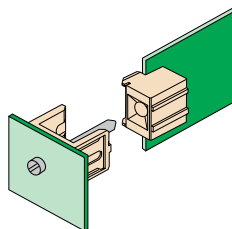
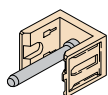

Guide Pin	
short, single-sided	70295-001LF
long, single-sided	70295-002LF

Required Header housing Wide Body	Required Receptacle housing
88911-101LF	70292-101LF

Extended Coding Keys

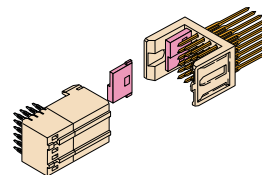

Colour	Header	Receptacle
Blue	85813-101LF	85814-101LF
Pink	85813-102LF	85814-102LF
Green	85811-101LF	85812-101LF

Header, Straight, Signal, High Speed

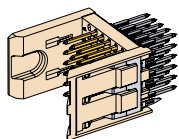

1 Module, High Speed, Press Fit		
	5 row	8 row
Signal 1000	84817-101001LF	74983-102011LF
Signal 2000	74977-101002LF	74978-102001LF
Signal 4000	55003-101004LF	55004-102002LF

Receptacle, Right Angle, High Speed

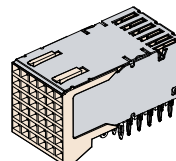

1 Module, High Speed, Press Fit		
	5 row	8 row
Signal 1000	73981-102LF	74981-102LF
Signal 4000	52057-102LF	-

	1000 Series Header	2000 Series Header	4000 Series Header
1000 Series Receptacle	622Mb/s	1.25 Gb/s	2.5 Gb/s
4000 Series Receptacle	1.25 Gb/s	2.5 Gb/s	5 Gb/s

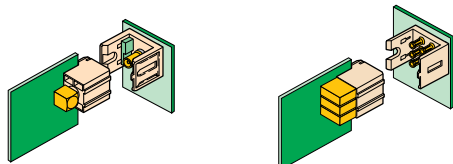

DIN Standard High Power	
Receptacle RA housing	89092-101LF
Receptacle contact	85995-103LF
Housing wide body	88911-101LF
Contact screw pcb	91570-001LF

Mini Coax	
Receptacle RA housing	70244-102LF
Receptacle contact stb	70239-002LF
Housing wide body	88913-101LF
Contact stb	88980-002LF

Cable Connector, Signal



Module	4 row	5 row
1	72476-1111LF	72478-1111LF
2	72477-1111LF	72479-1111LF

Cable Connector, Shielded

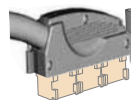

positions	4 row
72	10013881-231LF

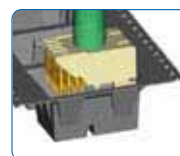
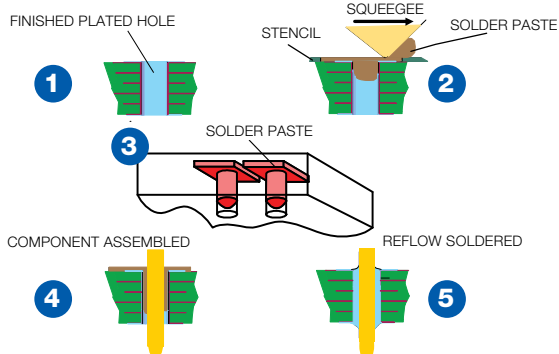



Description	4 row	5 row
Receptacle, RA, Signal	52048-101LF	52049-101LF
Receptacle, RA, Power	-	63793-101LF
Header, RA, Signal	58361-101LF	HM1L51LFP000H6PLF
Header, RA, Power	HM1K41DFP000H6PLF	HM1K51DFP000H6PLF
Sofix®, RA, Signal	72850-101LF	-



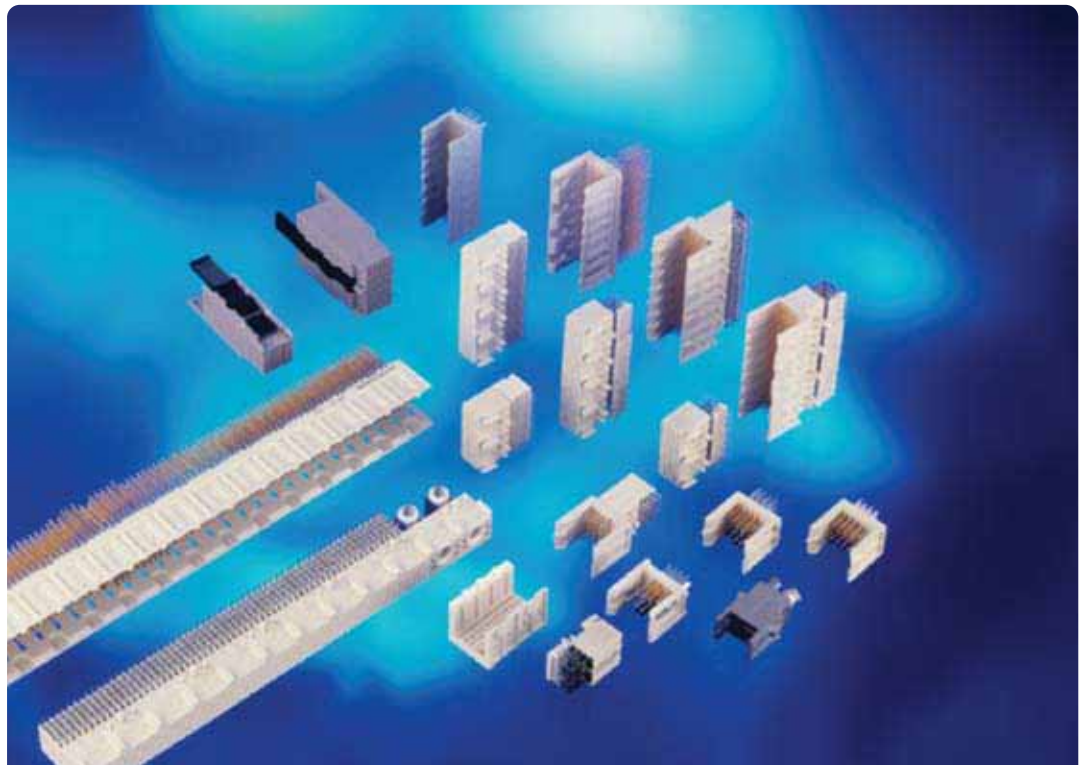







## METRAL® PRODUCT FINDER



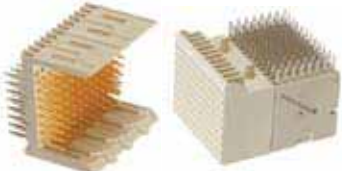

-  Easy access to select product
-  Diversity on application examples

## METRAL® SIGNAL CONNECTORS STANDARD

product	description					housing size				page
						12 mm	24 mm	48 mm	96 mm	
	Header	Straight	STB	Signal	wide body	4 x 6	4 x 12	4 x 24	4 x 48	24
	Header	Straight	PF	Signal	wide body	4 x 6	4 x 12	4 x 24	4 x 48	26
	Header	Straight	STB	Signal	narrow body	4 x 6				28
	Header	Straight	PF	Signal	narrow body	4 x 6				30
	Receptacle	RA	STB	Signal	-	4 x 6	4 x 12	4 x 24	4 x 48	32
	Receptacle	RA	PF	Signal	-	4 x 6	4 x 12	4 x 24	4 x 48	34
	Receptacle	RA	PIP	Signal	-	4 x 6				36
	Header	Straight	STB	Signal	wide body	5 x 6				38
	Header	Straight	PF	Signal	wide body	5 x 6	5 x 12	5 x 24	5 x 48	40
	Receptacle	RA	STB	Signal	-	5 x 6	5 x 12	5 x 24	5 x 48	42
	Receptacle	RA	PF	Signal	-	5 x 6	5 x 12	5 x 24	5 x 48	44
	Receptacle	RA	PIP	Signal	-	5 x 6				46
	Header	Straight	PF	Signal	wide body		8 x 12			48
	Receptacle	RA	PF	Signal	-		8 x 12			50

RA = right angle, STB = solder-to-board, PF = press-fit

## METRAL® SIGNAL CONNECTORS REVERSED





product	description					housing size				page
						12 mm	24 mm	48 mm	96 mm	
						number of lines				
	Header	RA	STB	Signal	wide body	4 x 6	4 x 12	4 x 24	4 x 48	54
	Header	RA	PF	Signal	wide body	4 x 6	4 x 12	4 x 24	4 x 48	56
	Header	RA	PIP	Signal	wide body	4 x 6				58
	Header	RA	STB	Signal	narrow body	4 x 6				60
	Header	RA	PF	Signal	narrow body	4 x 6				62
	Header	RA	PIP	Signal	narrow body	4 x 6				64
	Receptacle	Straight	STB	Signal	-	4 x 6	4 x 12	4 x 24	4 x 48	66
	Receptacle	Straight	PF	Signal	-	4 x 6	4 x 12	4 x 24	4 x 48	68
	Header	RA	STB	Signal	wide body	5 x 6	5 x 12	5 x 24	5 x 48	70
	Header	RA	PF	Signal	wide body	5 x 6	5 x 12	5 x 24	5 x 48	72
	Header	RA	PIP	Signal	wide body	5 x 6				74
	Receptacle	Straight	STB	Signal	-	5 x 6	5 x 12	5 x 24	5 x 48	76
	Receptacle	Straight	PF	Signal	-	5 x 6		5 x 24		78

RA = right angle, STB = solder-to-board, PF = press-fit

## METRAL® SHROUDS

product	description					housing size				page
						12 mm	24 mm	48 mm	96 mm	
						number of lines				
	Shroud	-	-	-	wide body	4 x 6	4 x 12	4 x 24	4 x 48	82
	Shroud	-	-	-	wide body	5 x 6	5 x 12	5 x 24	5 x 48	84
	Shroud	-	-		wide body		8 x 12			86

## METRAL® POWER CONNECTORS STANDARD

product	description					housing size				page
						12 mm	24 mm	48 mm	96 mm	
	Header	Straight	STB	Power	wide body	4 x 2				90
	Header	Straight	PF	Power	wide body	4 x 2				92
	Header	Straight	STB	Power	narrow body	4 x 2				94
	Header	Straight	PF	Power	narrow body	4 x 2				96
	Receptacle	RA	STB	Power	-	4 x 2				98
	Receptacle	RA	PF	Power	-	4 x 2				100
	Receptacle	RA	PIP	Power	-	4 x 2				102
	Header	Straight	STB	Power	wide body	5 x 2				104
	Header	Straight	PF	Power	wide body	5 x 2				106
	Receptacle	RA	STB	Power	-	5 x 2				108
	Receptacle	RA	PF	Power	-	5 x 2				110
	Receptacle	RA	PIP	Power	-	5 x 2				112

RA = right angle, STB = solder-to-board, PF = press-fit

## METRAL® POWER CONNECTORS REVERSED

product	description					housing size				page
						12 mm	24 mm	48 mm	96 mm	
	Header	RA	STB	Power	wide body	4 x 2				116
	Header	RA	PF	Power	wide body	4 x 2				118
	Header	RA	PIP	Power	wide body	4 x 2				120
	Receptacle	Straight	STB	Power	-	4 x 2				122
	Header	RA	STB	Power	wide body	5 x 2				124
	Header	RA	PF	Power	wide body	5 x 2				126
	Header	RA	PIP	Power	wide body	5 x 2				128
	Receptacle	Straight	STB	Power	-	5 x 2				130



RA = right angle, STB = solder-to-board, PF = press-fit

## METRAL® ELECTRICAL ENHANCED CONNECTORS

product	description					housing size				page
						12 mm	24 mm	48 mm	96 mm	
	Header	Straight	PF	Signal	wide body	5 + 2				134
	Shroud	-	-	-	wide body	5 + 2				136
	Receptacle	RA	PF	Signal	-	5 + 2				138

RA = right angle, STB = solder-to-board, PF = press-fit

## METRAL® SHIELDED SIGNAL CONNECTORS

product	description					housing size				page
						12 mm	24 mm	48 mm	96 mm	
	Header	Straight	STB	Signal	shielded	5 x 6				142
	Cable connector			Signal	shielded	5 x 6				144

RA = right angle, STB = solder-to-board, PF = press-fit

## METRAL® HIGH POWER CONNECTORS

product	description					housing size				page
						12 mm	24 mm	48 mm	96 mm	
	Header	RA	PF	Power	high power	1 x 2 2 x 2				148
	Receptacle	Straight	PF	Power	high power	1 x 2 2 x 2				150

RA = right angle, STB = solder-to-board, PF = press-fit



## METRAL® HYBRID CONNECTORS

product	description					housing size				page
						12 mm	24 mm	48 mm	96 mm	
	Header DIN standard	Straight	-	Power	high power	1				154
	Receptacle DIN standard	RA	-	Power	high power	1				156
	Header Mini Power	RA/ Straight		Power	mini power	6				158
	Receptacle Mini power	RA	-	Power	mini power	6				160
	Header DIN standard	Straight	-	Coax	coax	1				162
	Receptacle DIN standard	RA	-	Coax	coax	1				164
	Header Mini Coax	RA/ Straight		Coax	mini coax	6				166
	Receptacle Mini Coax	RA	-	Coax	mini coax	6				168

RA = right angle, STB = solder-to-board, PF = press-fit

## METRAL® CABLE CONNECTORS

product	description					housing size				page
						12 mm	24 mm	48 mm	96 mm	
	Cable Connector	-	-	Signal	-	4 x 6	4 x 12			172
	Cable Connector	-	-	Signal	-	5 x 6	5 x 12			174
	Cable Connector	-	-	Signal	Shielded			3 x 24		176

## METRAL® ACCESSORIES

product	description					housing size				page
						12 mm	24 mm	48 mm	96 mm	
	Coding Keys Header Cable conn.	-	-	-	-	-	-	-	-	180 182
	Guide Pin	-	-	-	-	1				184
	Board to Board Keying system	-	-	-	-	6				186
	Ramping module	-	-	-	-	1				188
	Shorting Clip Header	Straight	PF	Signal	wide body	-	4 x 12	4 x 24	4 x 48	190
	Shorting Clip Header	Straight	PF	Signal	wide body	5 x 6	-	-	-	192
	End wall	-	-	-	-					194
	Hybrid Housing					1				196

RA = right angle, STB = solder-to-board, PF = press-fit

# METRAL® 4 row assemblies

## UNMATED

## MATED

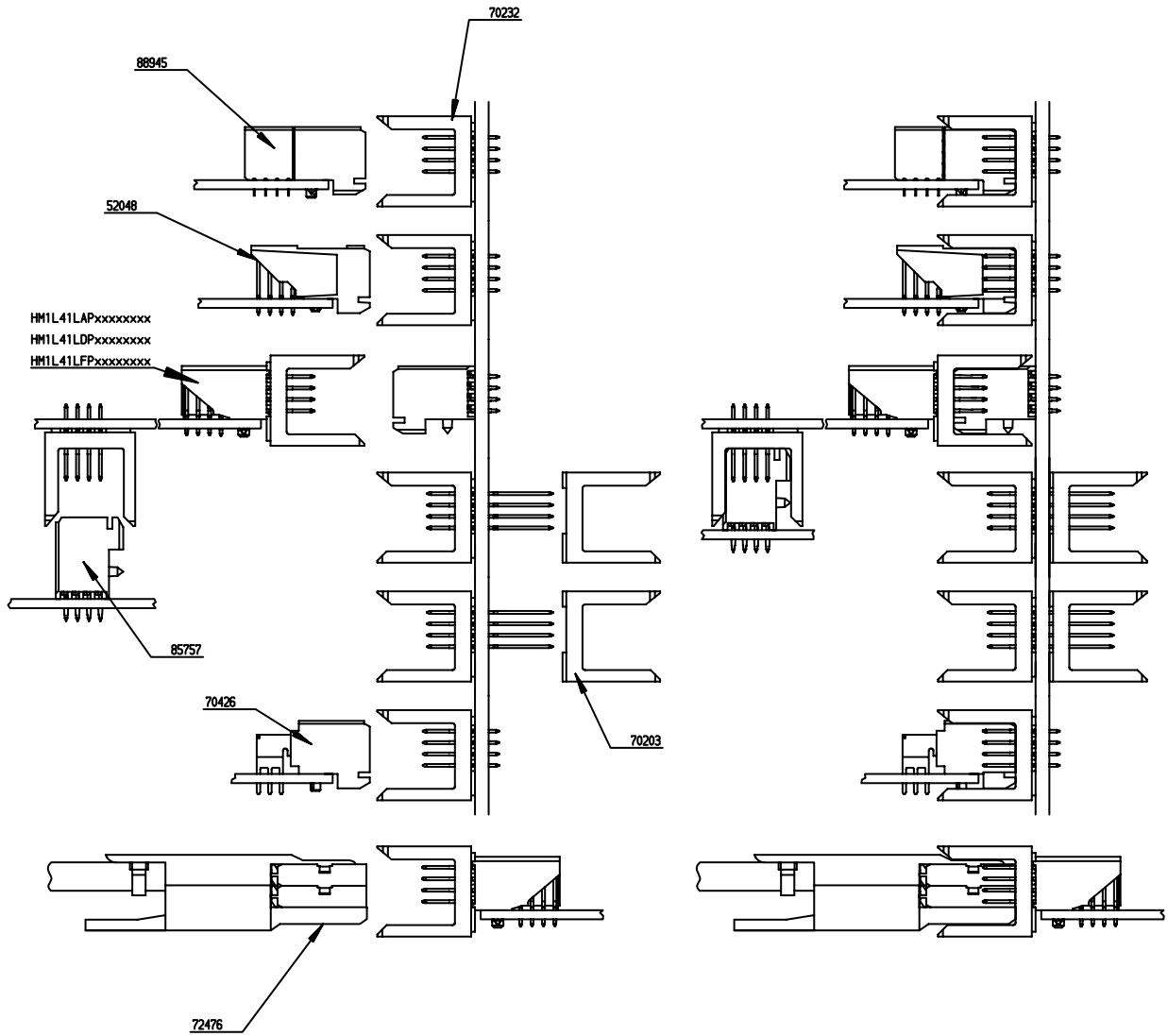

# METRAL® 5 row assemblies

UNMATED

MATED

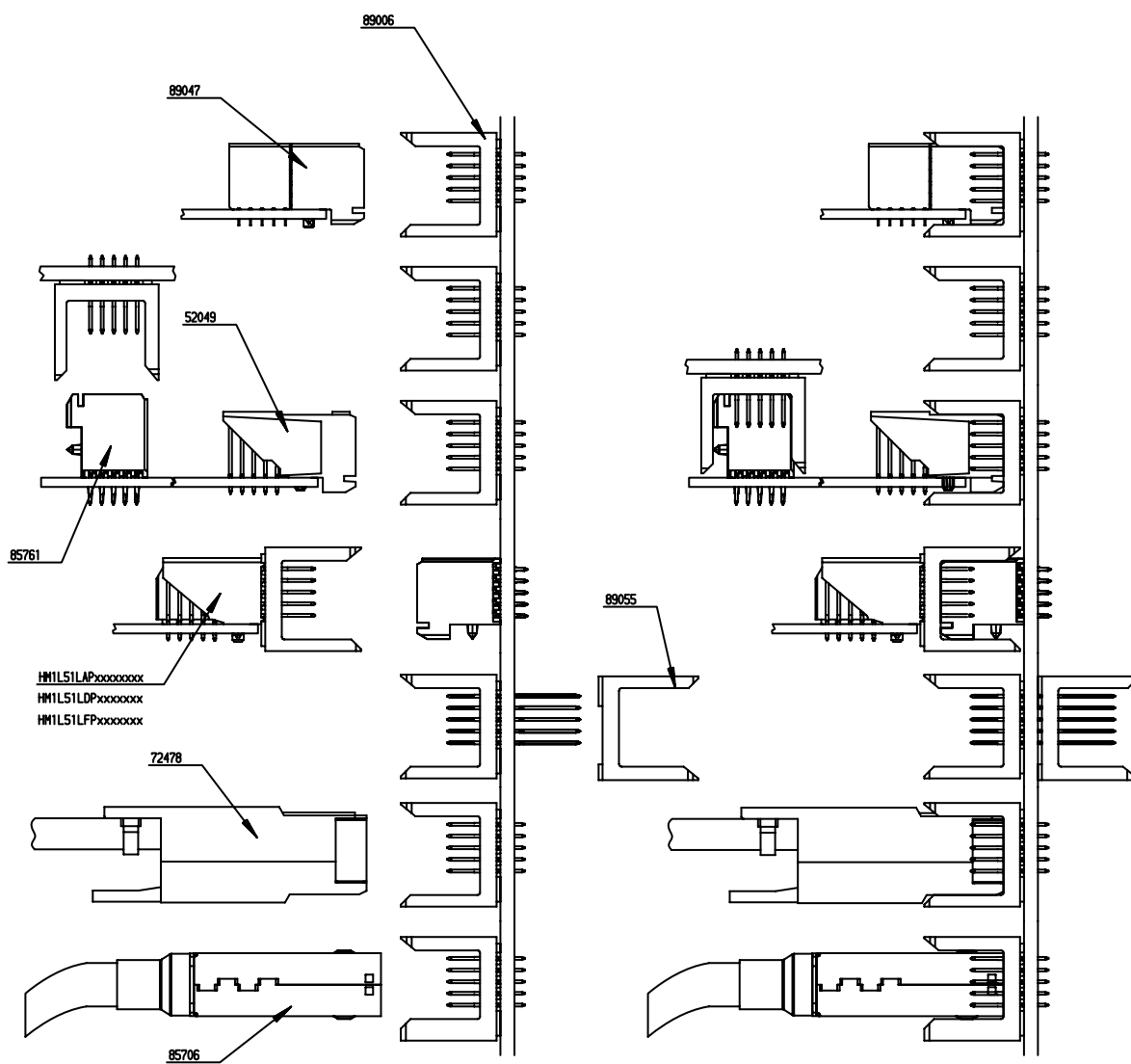

## METRAL® 8 row assemblies

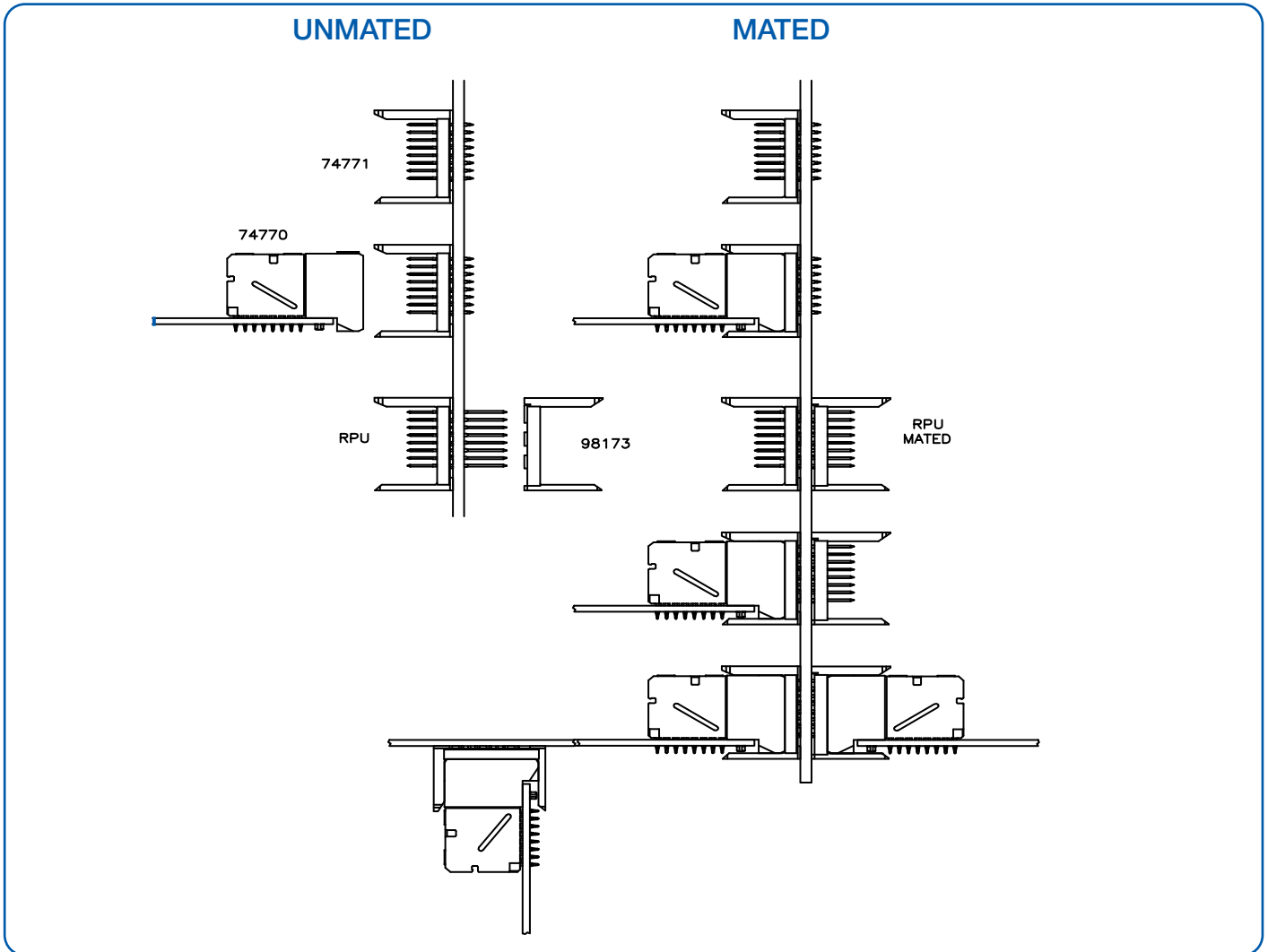

## METRAL® DIN High Power assemblies

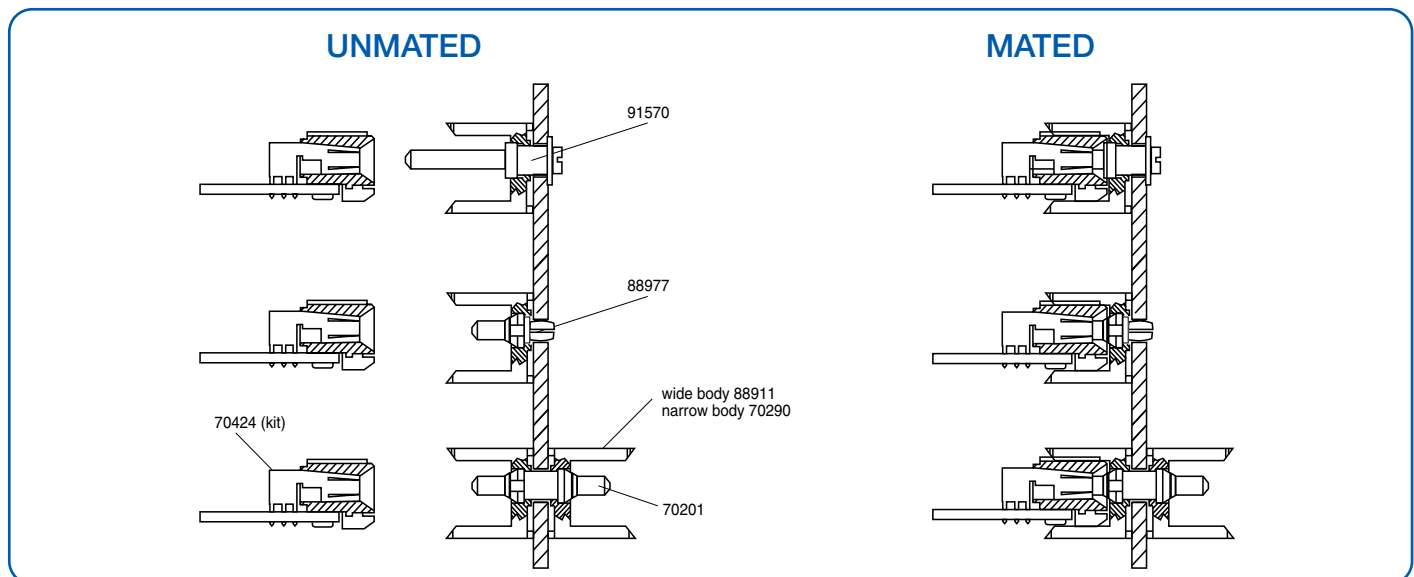



## METRAL® DIN standard Coax assemblies

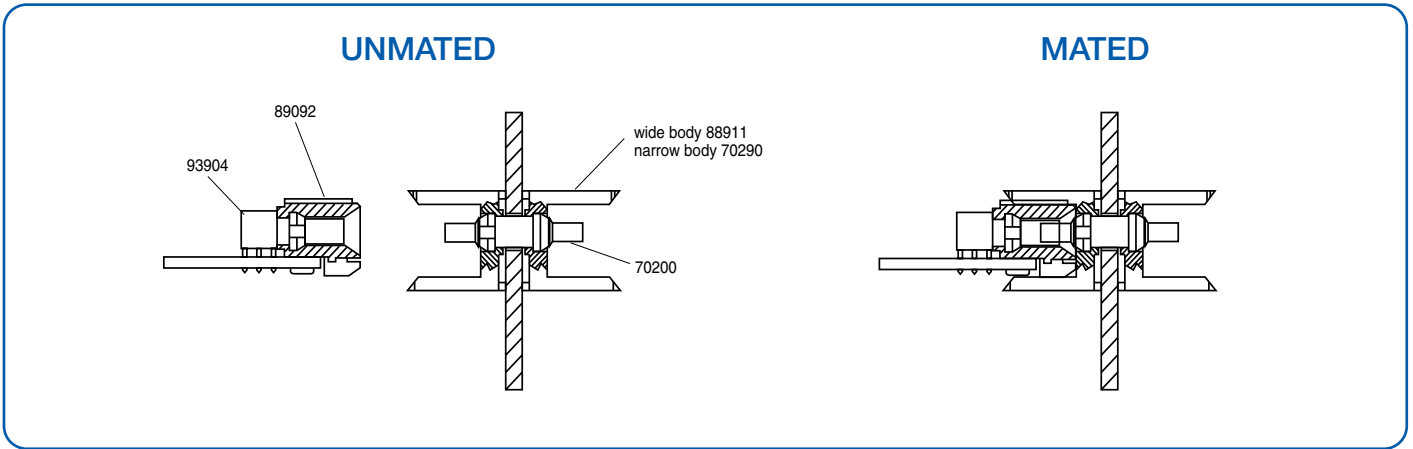

## METRAL® Mini Power assemblies

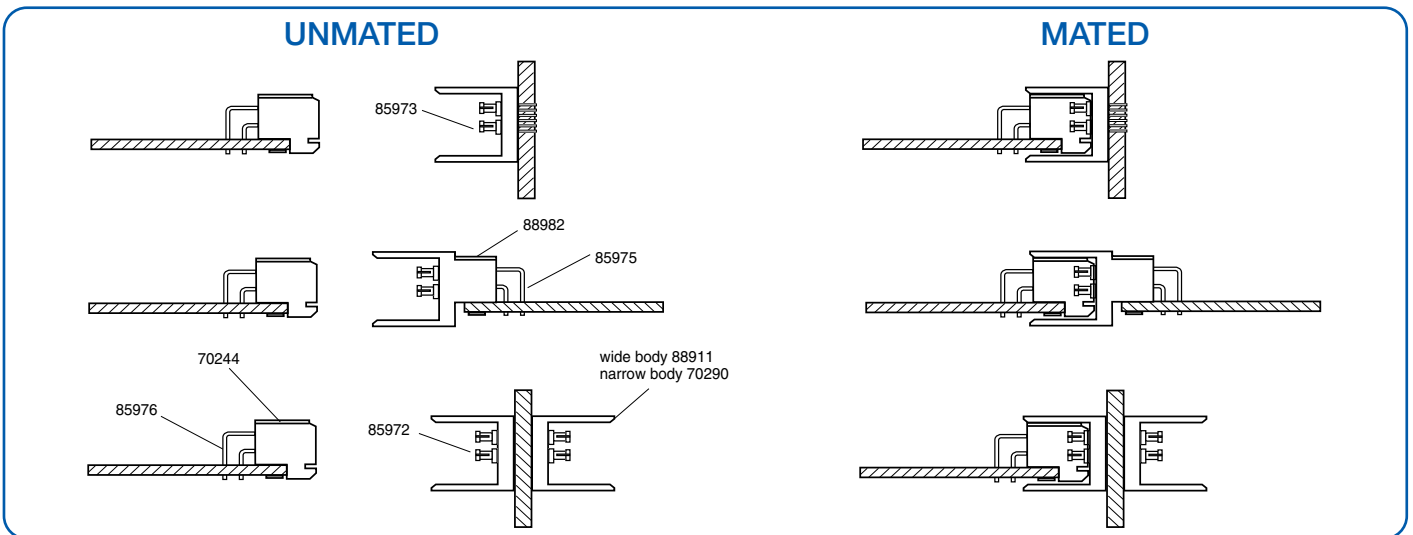

## METRAL® Mini Coax assemblies

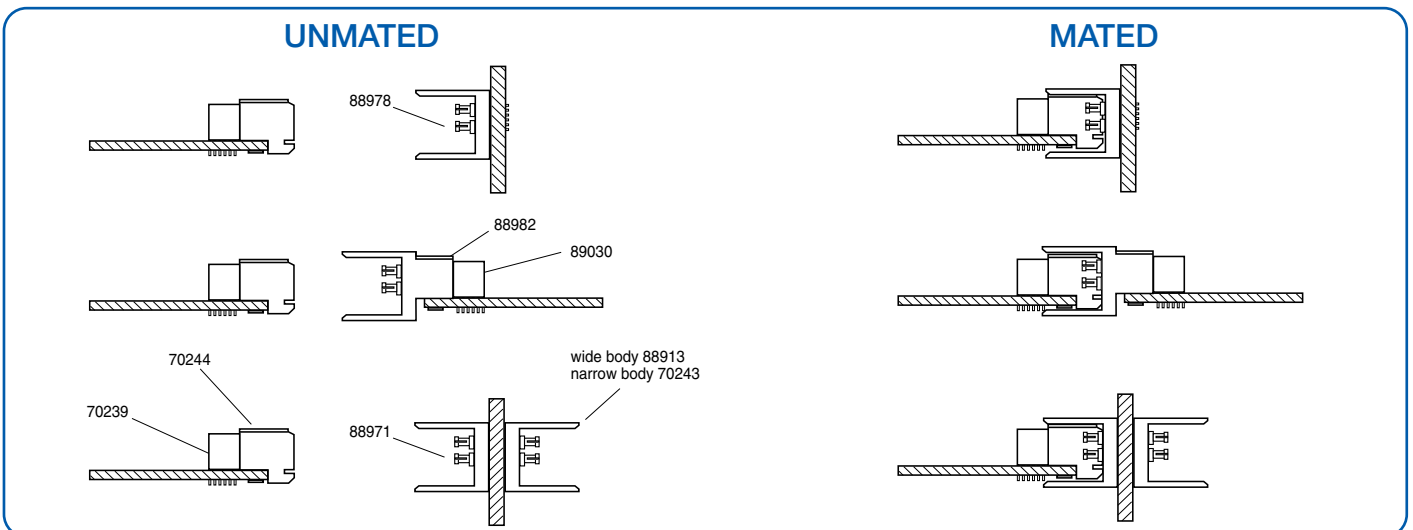



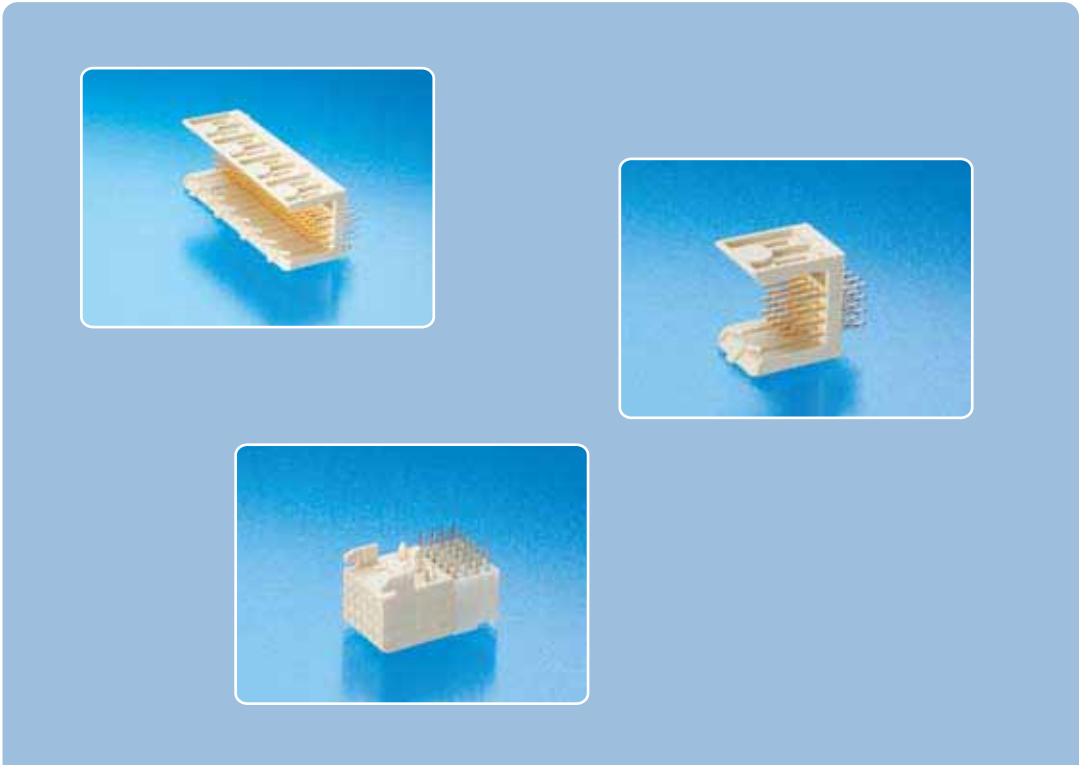

## METRAL® SIGNAL CONNECTORS STANDARD

- Header, 4 row, straight, wide body
- Header, 4 row, straight, narrow body
- Receptacle, 4 row, right angle
- Header, 5 row, straight, wide body
- Header, 5 row, straight, narrow body
- Receptacle, 5 row, right angle
- Header, 8 row, straight, wide body
- Receptacle, 8 row, right angle

# Header, 4 row, signal, straight, solder to board, wide body

## FEATURES

- In accordance with IEC 60917 and IEC 61076-4-104 (Futurebus+)
- 4 Rows and 2 mm pitch permit high signal density (200 contacts per 100 mm connector length).
- Stackable end-to-end without loss of positions.
- Stackable with other METRAL™ function modules (e.g. power, coax, guide pin).
- First Make Last Break options.

## TECHNICAL DATA

### PHYSICAL

- spacing: 2,00 mm x 2,00 mm
- housing: glass-filled LCP, colour natural
- flammability rating: UL 94 V-0
- pin material: phosphor bronze
- performance level: Telcordia CO

### ELECTRICAL

- current rating: 1 A
- insulation resistance: 5x10<sup>3</sup> MΩ initially, 1x10<sup>3</sup> MΩ after tests
- withstanding voltage: 1000 V rms (sea level)

### MECHANICAL PERFORMANCE

- insertion force: 0,45 N max. per individual signal contact (mating)
- withdrawal force: 0,15 N max. per individual signal contact (unmating)
- recommended hole diameter: 0,65-0,80 mm

### ENVIRONMENTAL

- Operating temperature range: -55°C to +125°C
- RoHs information, this product is compatible according to the European Union Directive 2002/95/IEC

### PACKAGING

- standard: tubes

### PROCESSING INFORMATION

- applicable soldering process: wave, IR, vapor phase

### REFERENCE DATA

- product specification.: GS-12-180

### APPLICATION EQUIPMENT

- for application equipment, check out the application equipment table on page 217-223



## MATING DATA

### Receptacle, right angle, press-fit, page 34

- 1 mod – part number 88945-102LF
- 2 mod – part number 88946-102LF
- 4 mod – part number 88947-102LF
- 8 mod – part number 88948-102LF

### Receptacle, right angle, solder-to-board, page 32

- 1 mod – part numbers 89035-102LF
- 2 mod – part numbers 89036-102LF
- 4 mod – part numbers 89037-102LF
- 8 mod - part numbers 89038-102LF

### Receptacle, right angle, Pin-in-Paste, page 36

- 1 mod – part numbers 52048-101LF

## TYPICAL APPLICATIONS

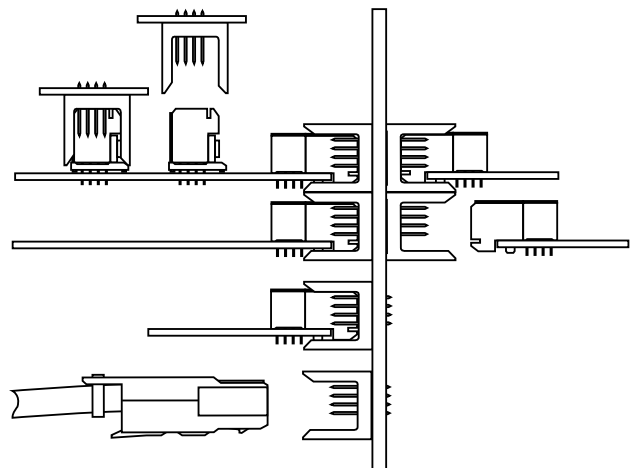

# Header, 4 row, signal, straight, solder to board, wide body

## PRODUCT

1 Module  
88951-1yyLF

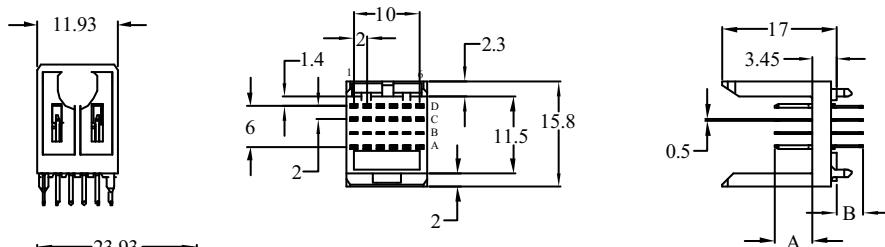

2 Module  
88952-1yyLF

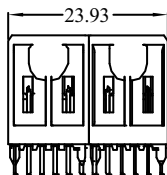

4 Module  
88953-1yyLF

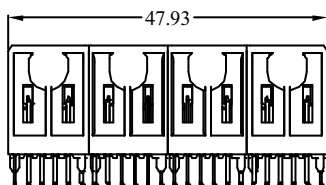

8 Module  
88954-1yyLF

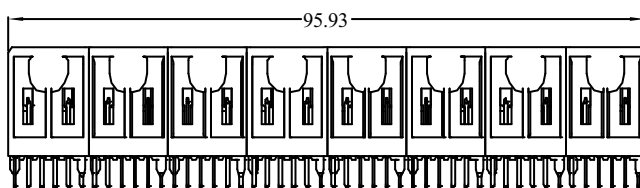

PCB pattern P5, see chapter PCB layouts

## PARTNUMBERS

8895x - 1yyLF

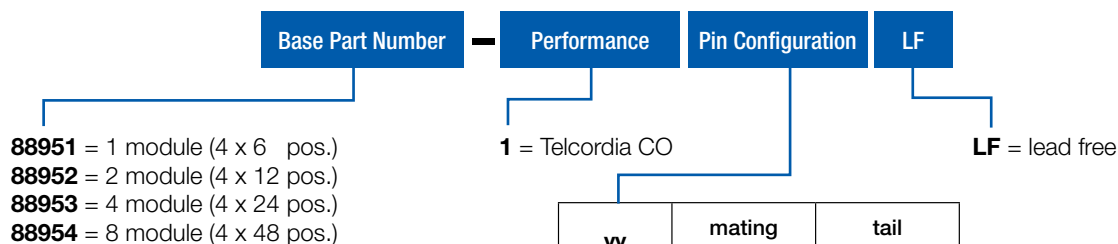

yy	mating length (A)	tail length(B)
01	5,00 mm	4,25 mm
05	6,50 mm	4,25 mm
31	5,00 mm	3,30 mm
35	6,50 mm	3,30 mm
61	5,00 mm	2,65 mm

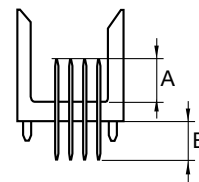

**Note:** for other special patterns or loadings, please check drawings, all other configurations on request only

## Header, 4 row, signal, straight, press-fit, wide body

### FEATURES

- In accordance with IEC 60917 and IEC 61076-4-104 (Futurebus+)
- 4 row and 2 mm pitch permit high signal density ( 200 contacts per 100mm connector length)
- Modular design guarantees flexibility
- Eye of the needle press-fit contact

### TECHNICAL DATA

#### PHYSICAL

- spacing: 2,00 mm x 2,00 mm
- housing: glass-filled LCP, colour natural
- flammability rating: UL 94 V-0
- pin material: phosphor bronze
- performance level: Telcordia CO

#### ELECTRICAL

- current rating: 1 A
- insulation resistance: 5x10<sup>3</sup> MΩ initially, 1x10<sup>3</sup> MΩ after tests
- withstanding voltage: 1000 V rms (sea level)

#### MECHANICAL PERFORMANCE

- insertion force: 0,45 N max. per individual signal contact (mating)
- withdrawal force: 0,15 N max. per individual signal contact (unmating)
- press-fit contact insertion: 65 N max. per pin
- press-fit pin withdrawal: 15 N min. per pin
- recommended hole diameter: 0,65-0,80 mm

#### ENVIRONMENTAL

- Operating temperature range: -55°C to +125°C
- RoHs information, this product is compatible according to the European Union Directive 2002/95/IEC

#### PACKAGING

- standard: tubes

#### PROCESSING INFORMATION

- Applicable process: press-fit

#### REFERENCE DATA

- product specification.: GS-12-180

#### APPLICATION EQUIPMENT

- for application equipment, check out the application equipment table on page 217-223.



### MATING DATA

#### ■ Receptacle, right angle, press-fit, page 34

- 1 mod – part number 88945-102LF
- 2 mod – part number 88946-102LF
- 4 mod – part number 88947-102LF
- 8 mod – part number 88948-102LF

#### ■ Receptacle, right angle, solder-to-board, page 32

- 1 mod – part numbers 89035-101LF
- 2 mod – part numbers 89036-101LF
- 4 mod – part numbers 89037-101LF
- 8 mod - part numbers 89038-101LF

#### ■ Receptacle right angle, Pin-in-Paste, page 36

- 1 mod – part numbers 52048-101LF

### TYPICAL APPLICATIONS

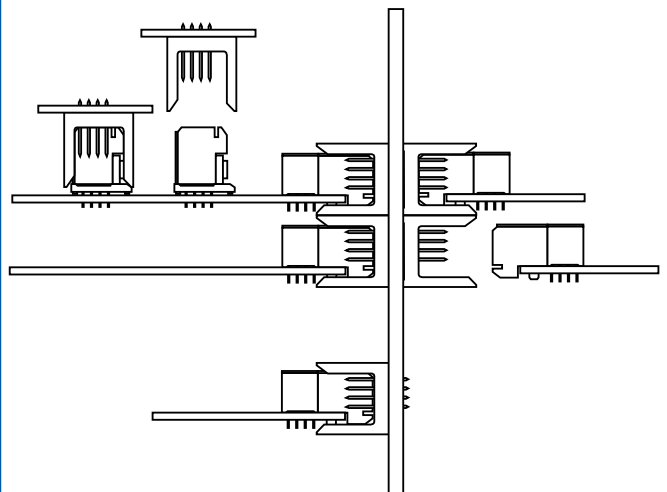



# Header, 4 row, signal, straight, press-fit, wide body

## PRODUCT

1 Module  
70232-1yyLF

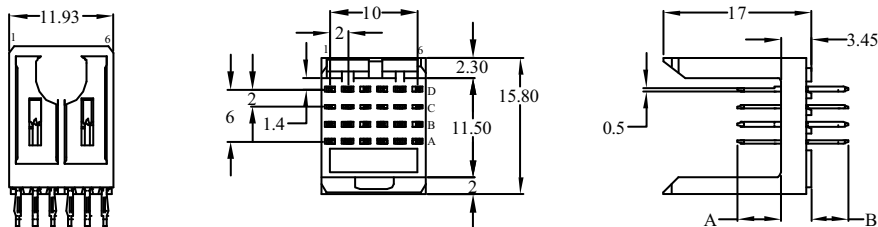

2 Module  
70233-1yyLF

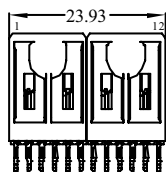

4 Module  
70234-1yyLF

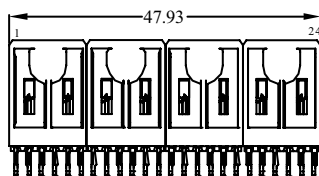

8 Module  
70235-1yyLF

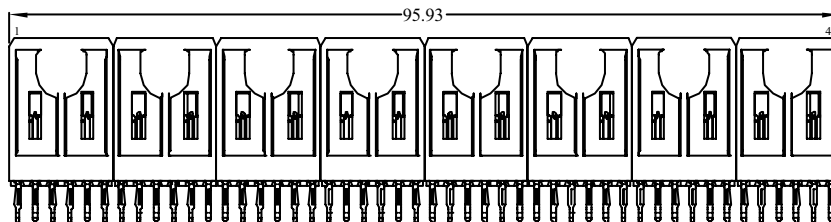

PCB pattern P6, see chapter PCB layouts

## PARTNUMBERS

7023x - 1yyLF

Base Part Number

Performance

Pin Configuration

LF

70232 = 1 module (4 x 6 pos.)  
70233 = 2 module (4 x 12 pos.)  
70234 = 4 module (4 x 24 pos.)  
70235 = 8 module (4 x 48 pos.)

1 = Telcordia CO

LF = lead free

yy	mating length (A)	tail length (B)
11	5,00 mm	4,30 mm
16	5,75 mm	4,30 mm
15	6,50 mm	4,30 mm
21	5,00 mm	13,60 mm
26	5,75 mm	13,60 mm
25	6,50 mm	13,60 mm

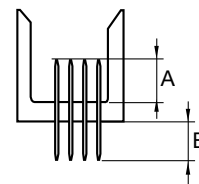

**Note:** blue marked in **pin configuration** is the preferred recommended standard  
for other special patterns or loadings, please check drawings, all other configurations on request only

## Header, 4 row, signal, straight, solder to board, narrow body

### FEATURES

- In accordance with IEC 60917 and IEC 61076-4-104 (Futurebus+)
- 4 Rows and 2 mm pitch permit high signal density (200 contacts per 100 mm connector length).
- Stackable end-to-end without loss of positions.
- Stackable with other METRAL™ function modules (e.g. power, coax, guide pin).
- First Make Last Break options.

### TECHNICAL DATA

#### PHYSICAL

- spacing: 2,00 mm x 2,00 mm
- housing: glass-filled LCP, colour natural
- flammability rating: UL 94 V-0
- pin material: phosphor bronze
- performance level: Telcordia CO

#### ELECTRICAL

- current rating: 1 A
- insulation resistance:  $5 \times 10^3 \text{ M}\Omega$  initially,  $1 \times 10^3 \text{ M}\Omega$  after tests
- withstanding voltage: 1000 V rms (sea level)

#### MECHANICAL PERFORMANCE

- insertion force: 0,45 N max. per individual signal contact (mating)
- withdrawal force: 0,15 N max. per individual signal contact (unmating)
- recommended hole diameter: 0,65-0,80 mm

#### ENVIRONMENTAL

- Operating temperature range: -55°C to +125°C
- RoHs information, this product is compatible according to the European Union Directive 2002/95/IEC

#### PACKAGING

- standard: tubes

#### PROCESSING INFORMATION

- applicable soldering process: wave, IR, vapor phase

#### REFERENCE DATA

- product specification.: GS-12-180

#### APPLICATION EQUIPMENT

- for application equipment, check out the application equipment table on page 217-223



### MATING DATA

#### Receptacle, straight

- 1 mod – pf - part number 85757-1101LF, page 69
- 1 mod – stb -part nr HM1S41FRR000H6PLF, page 67

#### Receptacle, right angle

- 1 mod – pf - part number 88945-102LF, page 35
- 1 mod – stb -part number 89035-102LF, page 33
- 1 mod – pip -part number 52048-101LF, page 37

### TYPICAL APPLICATIONS

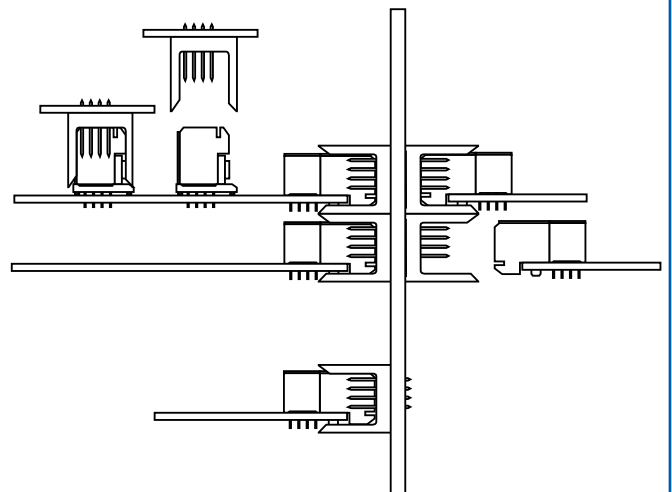

# Header, 4 row, signal, straight, solder to board, narrow body

## PRODUCT

1 Module  
70264-1yyLF

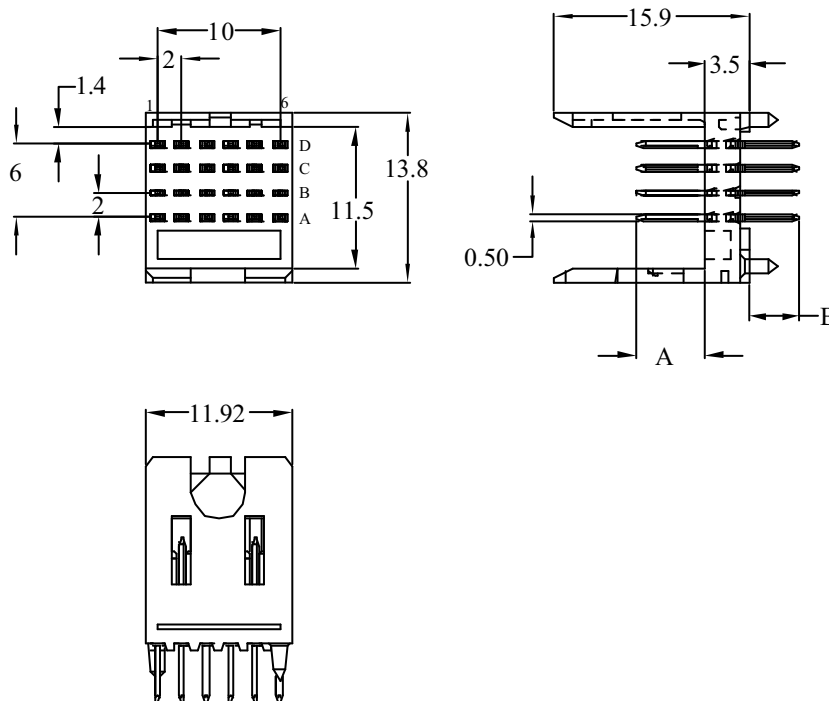

PCB pattern P3, see chapter PCB layouts

## PARTNUMBERS

70264 - 1yyLF

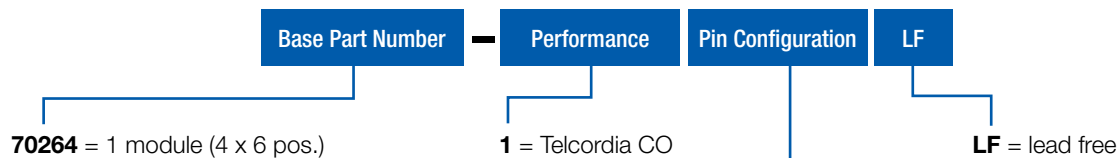

yy	mating length (A)	tail length (B)
01	5,00 mm	4,25 mm
05	6,50 mm	4,25 mm

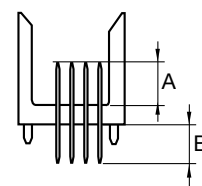

**Note:** for other special patterns or loadings, please check drawings, all other configurations on request only

## Header, 4 row, signal, straight, press-fit, narrow body

### FEATURES

- In accordance with IEC 60917 and IEC 61076-4-104 (Futurebus+)
- 4 Rows and 2 mm pitch permit high signal density (200 contacts per 100 mm connector length).
- Stackable end-to-end without loss of positions.
- Stackable with other METRAL™ function modules (e.g. power, coax, guide pin).
- First Make Last Break options.
- Eye the needle press-fit contact

### TECHNICAL DATA

#### PHYSICAL

- spacing: 2,00 mm x 2,00 mm
- housing: glass-filled LCP, colour natural
- flammability rating: UL 94 V-0
- pin material: phosphor bronze
- performance level: Telcordia CO

#### ELECTRICAL

- current rating: 1 A
- insulation resistance:  $5 \times 10^3 \text{ M}\Omega$  initially,  $1 \times 10^3 \text{ M}\Omega$  after tests
- withstanding voltage: 1000 V rms (sea level)

#### MECHANICAL PERFORMANCE

- insertion force: 0,45 N max. per individual signal contact (mating)
- withdrawal force: 0,15 N max. per individual signal contact (unmating)
- press-fit contact insertion: 65 N max. per pin
- press-fit pin withdrawal: 15 N min. per pin
- recommended hole diameter: 0,65-0,80 mm

#### ENVIRONMENTAL

- Operating temperature range: -55°C to +125°C
- RoHs information, this product is compatible according to the European Union Directive 2002/95/IEC

#### PACKAGING

- standard: tubes

#### PROCESSING INFORMATION

- press fit

#### REFERENCE DATA

- product specification.: GS-12-180

#### APPLICATION EQUIPMENT

- for application equipment, check out the application equipment table on page 217-223



### MATING DATA

#### Receptacle, straight

- 1 mod – pf - part number 85757-1101LF, page 69
- 1 mod – stb -part nr HM1S41FRR000H6PLF, page 67

#### Receptacle, right angle

- 1 mod – pf - part number 88945-102LF, page 35
- 1 mod – stb -part number 89035-102LF, page 33
- 1 mod – pip -part number 52048-101LF, page 37

### TYPICAL APPLICATIONS

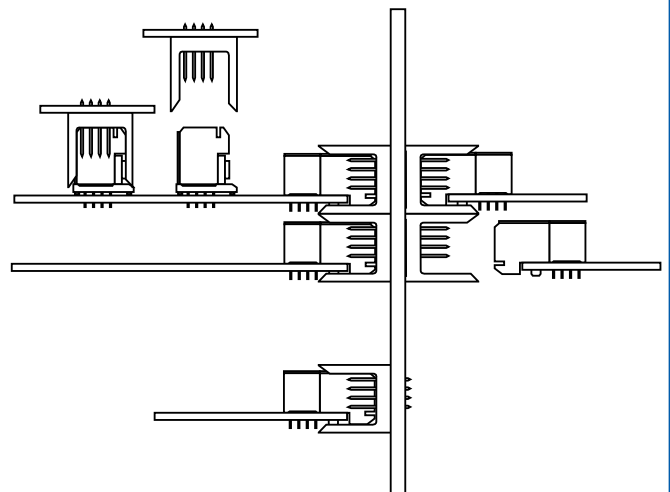

# Header, 4 row, signal, straight, press-fit, narrow body

## PRODUCT

1 Module  
85826-1yyLF

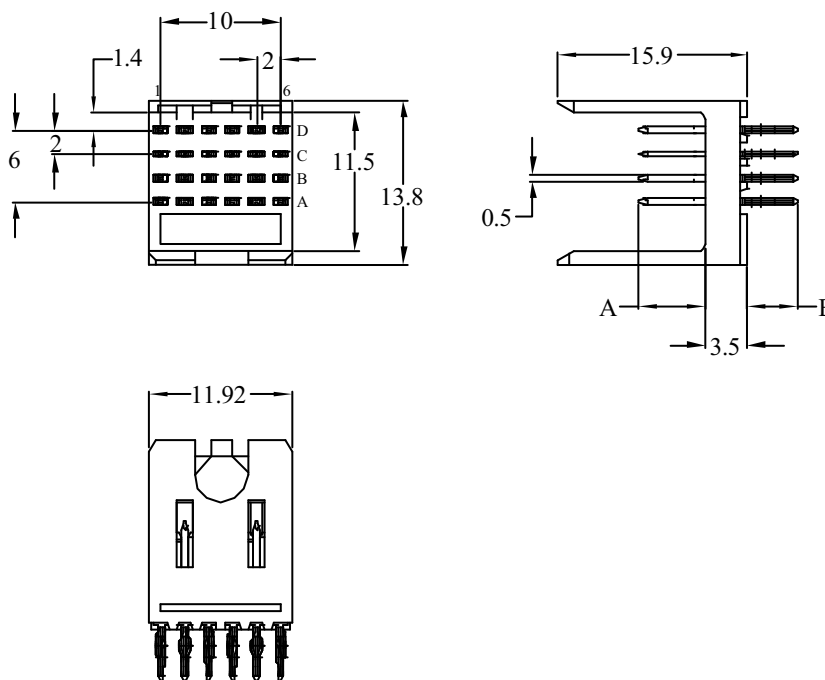

PCB pattern P4, see chapter PCB layouts

## PARTNUMBERS

85826 - 1yyLF

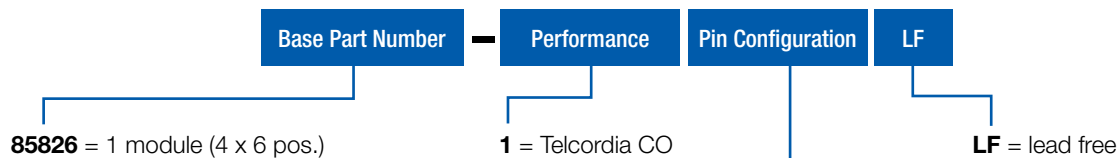

yy	mating length (A)	tail length (B)
01	5,00 mm	4,25 mm

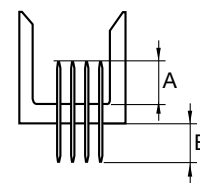

**Note:** for other special patterns or loadings, please check drawings, all other configurations on request only

## Receptacle, 4 row, signal, right angle, solder to board

### FEATURES

- In accordance with IEC 60917 and IEC 61076-4-104 (Futurebus+)
- 4 row and 2 mm pitch permit high signal density (200 contacts per 100mm connector length)
- Modular design guarantees flexibility
- Stackable end-to-end without loss of position
- Stackable with other METRAL® function modules (power, I/O)
- Reliable dual beam box contact
- Stable PCB fixation device
- Low profile allows PCB spacing of 14mm

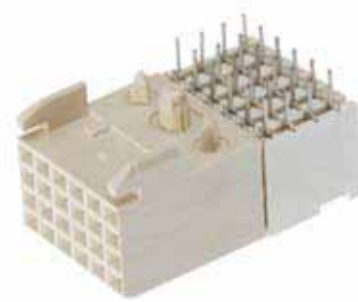

### TECHNICAL DATA

#### PHYSICAL

- spacing: 2,00 mm x 2,00 mm
- housing: glass-filled LCP, colour natural
- flammability rating: UL 94 V-0
- contact material: phosphor bronze
- performance level: Telcordia CO

#### ELECTRICAL

- current rating: 1 A
- insulation resistance: 5x10<sup>3</sup> MΩ initially, 1x10<sup>3</sup> MΩ after tests
- withstanding voltage: 1000 V rms (sea level)

#### MECHANICAL PERFORMANCE

- insertion force: 0,45 N max. per individual signal contact (mating)
- withdrawal force: 0,15 N max. per individual signal contact (unmating)
- Recommended hole diameter: 0,65 – 0,80 mm

#### ENVIRONMENTAL

- Operating temperature range: -55°C to +125°C
- RoHs information, this product is compatible according to the European Union Directive 2002/95/IEC

#### PACKAGING

- standard: tubes

#### PROCESSING INFORMATION

- Applicable process: wave, IR, vapor phase

#### REFERENCE DATA

- Press-peg application, TA-0941
- product specification.: GS-12-453

#### APPLICATION EQUIPMENT

- for application equipment, check out the application equipment table on page 217-223

### MATING DATA

#### Header, straight, press-fit, page 27

- 1 module – part number 70232-116LF
- 2 modules – part number 70233-116LF
- 4 modules – part number 70234-116LF
- 8 modules – part number 70235-116LF

#### Headerstraight, solder-to-board, page 25

- 1 module – part number 88951-101LF
- 2 modules – part number 88952-101LF
- 4 modules – part number 88953-101LF
- 8 modules – part number 88954-101LF

### TYPICAL APPLICATIONS

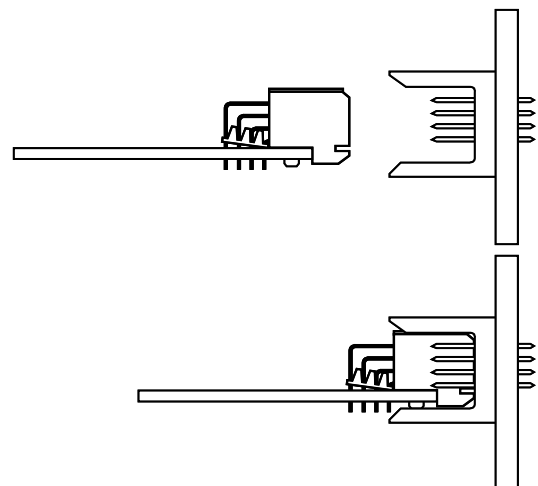

# Receptacle, 4 row, signal, right angle, solder to board

## PRODUCT

**1 Module**  
89035-1yyLF

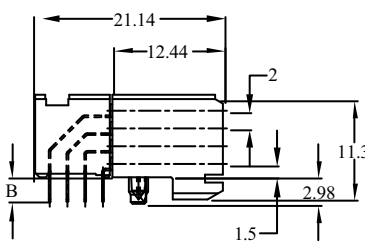
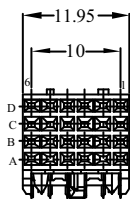

**2 Module**  
89036-1yyLF

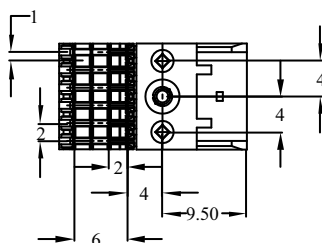
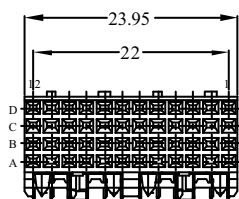

**4 Module**  
89037-1yyLF

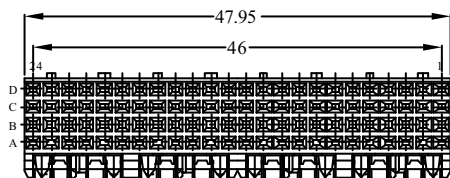

**8 Module**  
89038-1yyLF

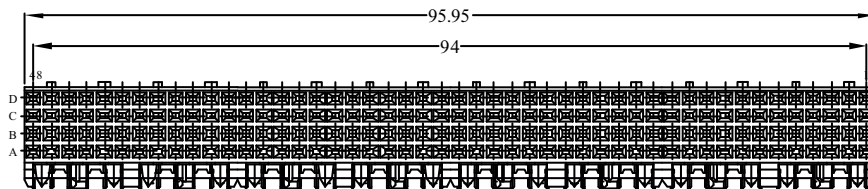

PCB pattern P1, see chapter PCB layouts

## PARTNUMBERS

8903x - 1yyLF

Base Part Number

Performance

Pin Configuration

LF

89035 = 1 module (4 x 6 pos.)  
89036 = 2 module (4 x 12 pos.)  
89037 = 4 module (4 x 24 pos.)  
89038 = 8 module (4 x 48 pos.)

1 = Telcordia CO

LF = lead free

yy	tail length (B)	PCB thickness
02	2,90 mm	1,60 mm
12	3,53 mm	2,40 mm

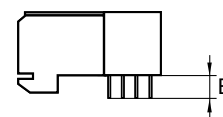

## Receptacle, 4 row, signal, right angle, press fit

### FEATURES

- In accordance with IEC 60917 and IEC 61076-4-104 (Futurebus+)
- 4 row and 2 mm pitch permit high signal density (200 contacts per 100mm connector length)
- Modular design guarantees flexibility
- Stackable end-to-end without loss of position
- Stackable with other METRAL® function modules (power, I/O)
- Reliable dual beam box contact
- Stable PCB fixation device
- Press block ensures accurate position of press-fit tails for easy mounting
- Eye the needle press-fit contact
- Low profile allows PCB spacing of 14mm



### TECHNICAL DATA

#### PHYSICAL

- spacing: 2,00 mm x 2,00 mm
- housing: glass-filled LCP, colour natural
- flammability rating: UL 94 V-0
- contact material: phosphor bronze
- performance level: Telcordia CO

#### ELECTRICAL

- current rating: 1 A
- insulation resistance:  $5 \times 10^3 \text{ M}\Omega$  initially,  $1 \times 10^3 \text{ M}\Omega$  after tests
- withstanding voltage: 1000 V rms (sea level)

#### MECHANICAL PERFORMANCE

- insertion force: 0,45 N max. per individual signal contact (mating)
- withdrawal force: 0,15 N max. per individual signal contact (unmating)
- press-fit contact insertion: 55 N max. per pin
- press-fit pin withdrawal: 15 N min. per pin
- recommended hole diameter: 0,65-0,80 mm

#### ENVIRONMENTAL

- Operating temperature range:  $-55^\circ\text{C}$  to  $+125^\circ\text{C}$
- RoHs information, this product is compatible according to the European Union Directive 2002/95/IEC

#### PACKAGING

- standard: tubes

#### PROCESSING INFORMATION

- press fit

#### REFERENCE DATA

- Press-peg application, TA-0941
- product specification.: GS-12-453

#### APPLICATION EQUIPMENT

- for application equipment, check out the application equipment table on page 217-223

### MATING DATA

#### Header, straight, press-fit, page 27

- 1 module – part number 70232-116LF
- 2 modules – part number 70233-116LF
- 4 modules – part number 70234-116LF
- 8 modules – part number 70235-116LF

#### Header, straight, solder-to-board, page 25

- 1 module – part number 88951-101LF
- 2 modules – part number 88952-101LF
- 4 modules – part number 88953-101LF
- 8 modules – part number 88954-101LF

### TYPICAL APPLICATIONS

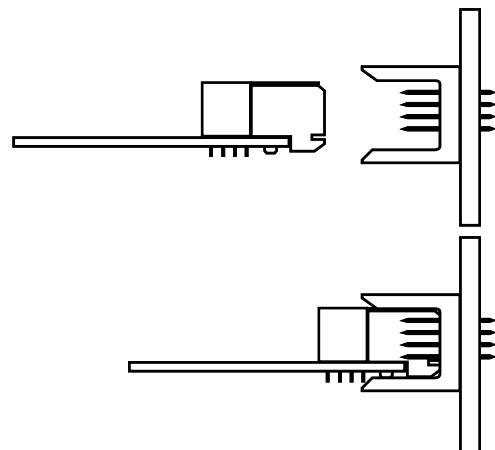



# Receptacle, 4 row, signal, right angle, press fit

## PRODUCT

1 Module  
88945-1yyLF

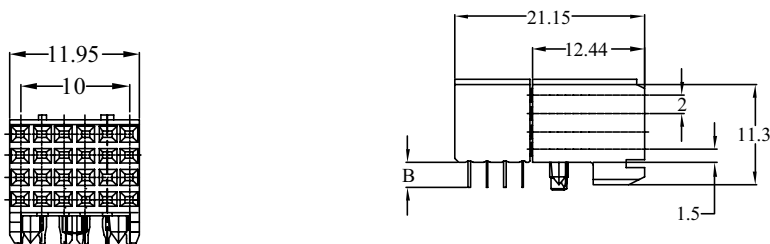

2 Module  
88946-1yyLF

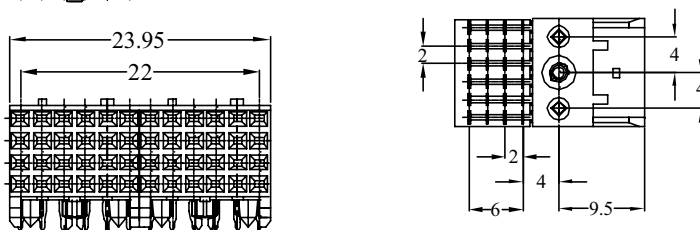

4 Module  
88947-1yyLF

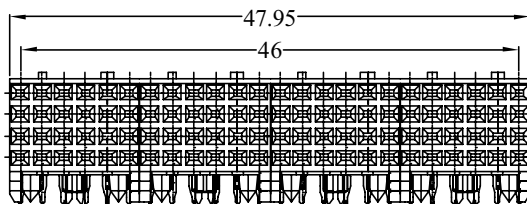

8 Module  
88948-1yyLF

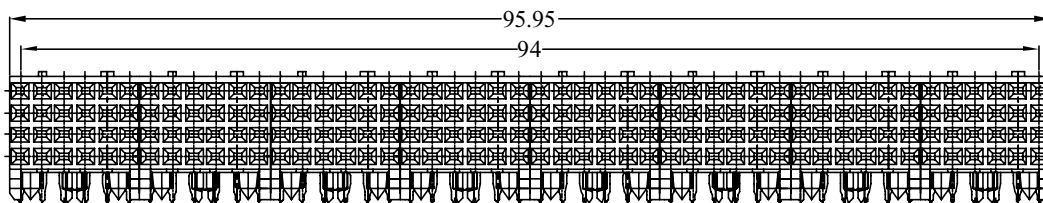

PCB pattern P1, see chapter PCB layouts

## PARTNUMBERS

8894x - 1yyLF

Base Part Number

Performance

Pin Configuration

LF

88945 = 1 module (4 x 6 pos.)  
88946 = 2 module (4 x 12 pos.)  
88947 = 4 module (4 x 24 pos.)  
88948 = 8 module (4 x 48 pos.)

1 = Telcordia CO

LF = lead free

yy	tail length (B)	PCB thickness
02	2,90 mm	1,60 mm
12	3,53 mm	2,40 mm

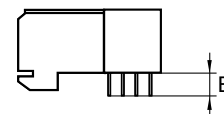

**Note:** blue marked in pin configuration is the preferred recommended standard  
for other special patterns or loadings, please check drawings, all other configurations on request only

## Receptacle, 4 row, signal, right angle, pin-in-paste

### FEATURES

- In accordance with IEC 60917 and IEC 61076-4-104 (Futurebus+)
- 4 row and 2 mm pitch permit high signal density, 1 module (4 x 6 positions)
- Modular design guarantees flexibility
- Stackable end-to-end without loss of position
- Stackable with other METRAL® function modules (power, I/O)
- Tuning fork, forced controlled contact
- Stable PCB fixation device
- Low profile allows PCB spacing of 14mm



### TECHNICAL DATA

- **PHYSICAL**
  - spacing: 2,00 mm x 2,00 mm
  - housing: glass-filled LCP (30% glass), colour natural
  - flammability rating: UL 94 V-0
  - contact material: phosphor bronze
  - performance level: Telcordia CO
- **ELECTRICAL**
  - current rating: 1 A
  - insulation resistance: 5x10<sup>3</sup> MΩ initially, 1x10<sup>3</sup> MΩ after tests
  - withstanding voltage: 1000 V rms (sea level)
- **MECHANICAL PERFORMANCE**
  - Maximum mounting force, 20 N per connector
  - insertion force: 0,45 N max. per individual signal contact (mating)
  - withdrawal force: 0,15 N max. per individual signal contact (unmating)
  - Recommended hole diameter: 0,65 – 0,80 mm
- **ENVIRONMENTAL**
  - Operating temperature -55°C to + 125°C
  - Max. temperature 260°C for 30 seconds
  - RoHs information, this product is compatible according to the European Union Directive 2002/95/IEC
- **PACKAGING**
  - Tape&reel
- **PROCESSING INFORMATION**
  - Pick&place by vacuum nozzle or mechanical gripper
  - automatic Surface-mount reflow process, resistance for Lead Free reflow temperature
- **REFERENCE DATA**
  - Product specification GS-12-215
- **APPLICATION EQUIPMENT**
  - for application equipment, check out the application equipment table on page 217-223

### MATING DATA

- Header, straight, press-fit, page 27
  - 1 module – part number 70232-116LF
- Header, straight, solder-to-board, page 25
  - 1 module – part number 88951-101LF

### TYPICAL APPLICATIONS

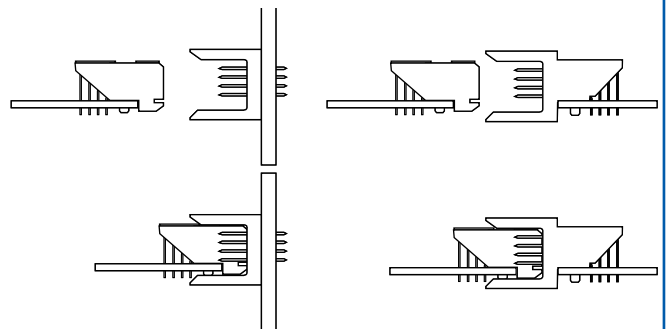

# Receptacle, 4 row, signal, right angle, pin-in-paste

## PRODUCT

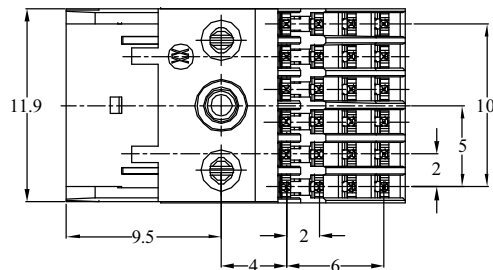
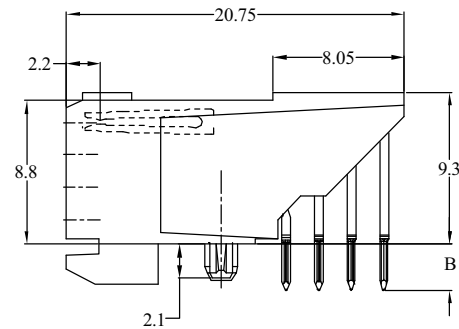
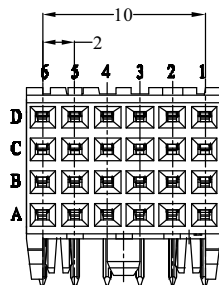

PCB pattern P1, see chapter PCB layouts

## PARTNUMBERS

52048 - 1yyLF

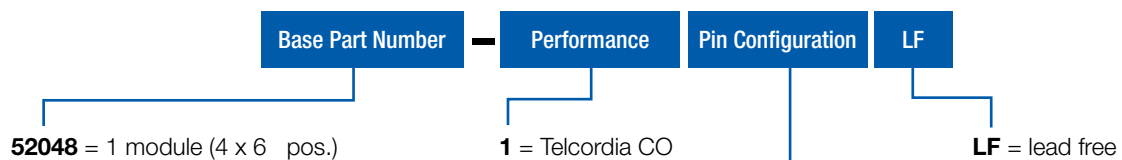

yy	tail length (B)	PCB thickness
01	2,80 mm	1,60 mm

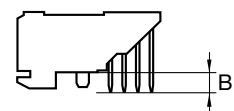

**Note:** blue marked in **pin configuration** is the preferred recommended standard for other special patterns or loadings, please check drawings, all other configurations on request only

## Header, 5 row, signal, straight, solder to board, wide body

### FEATURES

- In accordance with IEC 60917 and IEC 61076-4-104 (Futurebus+)
- 5 Rows and 2 mm pitch permit high signal density (200 contacts per 100 mm connector length).
- Stackable end-to-end without loss of positions.
- Stackable with other METRAL™ function modules (e.g. power, coax, guide pin).
- First Make Last Break options.

### TECHNICAL DATA

#### PHYSICAL

- spacing: 2,00 mm x 2,00 mm
- housing: glass-filled LCP, colour natural
- flammability rating: UL 94 V-0
- pin material: phosphor bronze
- performance level: Telcordia CO

#### ELECTRICAL

- current rating: 1 A
- insulation resistance:  $5 \times 10^3 \text{ M}\Omega$  initially,  $1 \times 10^3 \text{ M}\Omega$  after tests
- withstanding voltage: 1000 V rms (sea level)

#### MECHANICAL PERFORMANCE

- insertion force: 0,45 N max. per individual signal contact (mating)
- withdrawal force: 0,15 N max. per individual signal contact (unmating)
- recommended hole diameter: 0,65-0,80 mm

#### ENVIRONMENTAL

- Operating temperature range:  $-55^\circ\text{C}$  to  $+125^\circ\text{C}$
- RoHs information, this product is compatible according to the European Union Directive 2002/95/IEC

#### PACKAGING

- standard: tubes

#### PROCESSING INFORMATION

- applicable soldering process: wave, IR, vapor phase

#### REFERENCE DATA

- product specification.: GS-12-180

#### APPLICATION EQUIPMENT

- for application equipment, check out the application equipment table on page 217-223



### MATING DATA

#### ■ Receptacle, right angle, press-fit, page 45

- 1 mod – part number 89047-102LF
- 2 mod – part number 89093-102LF
- 4 mod – part number 89094-102LF
- 8 mod – part number 89095-102LF

#### ■ Receptacle, right angle, solder-to-board, page 43

- 1 mod – part numbers 85863-102LF
- 2 mod – part numbers 85864-102LF
- 4 mod – part numbers 85865-102LF
- 8 mod - part numbers 85866-102LF

### TYPICAL APPLICATIONS

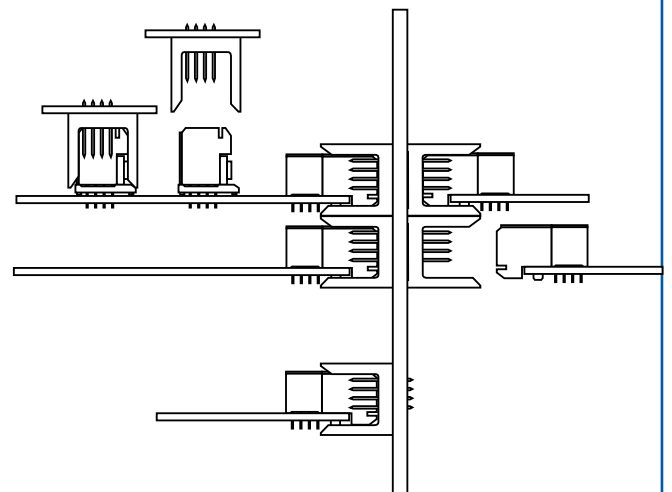

# Header, 5 row, signal, straight, solder to board, wide body

## PRODUCT

**1 Module**  
74741-1yyLF

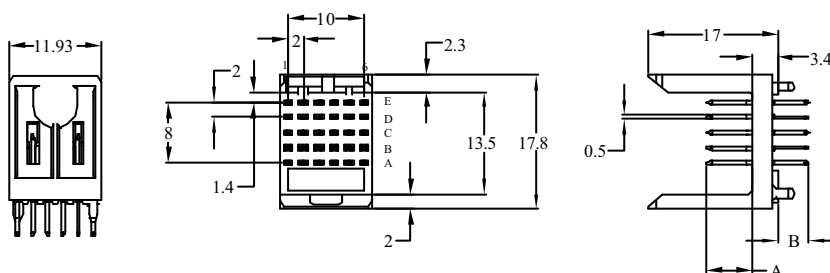

**2 Module**  
7474x-1yyLF  
*on request only*

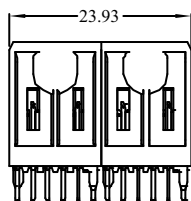

**4 Module**  
7474x-1yyLF  
*on request only*

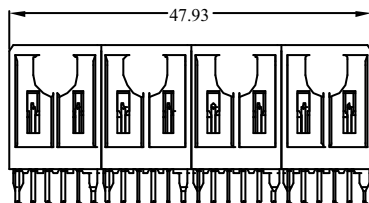

**8 Module**  
7474x-1yyLF  
*on request only*

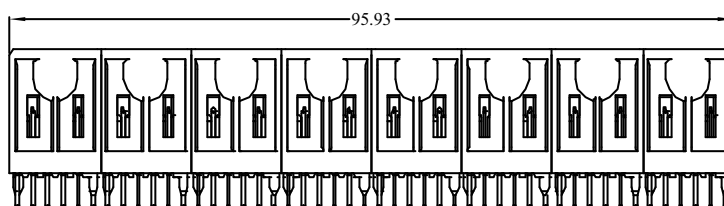

PCB pattern P16, see chapter PCB layouts

## PARTNUMBERS

74741 - 1yyLF

Base Part Number

Performance

Pin Configuration

LF

**74741**  
*on request only*  
*on request only*  
*on request only*  
*on request only*

- = 1 module (5 x 6 pos.)
- = 2 module (5 x 12 pos.)
- = 4 module (5 x 24 pos.)
- = 8 module (5 x 48 pos.)

**1** = Telcordia CO

**LF** = lead free

yy	mating length (A)	tail length (B)
63	5,00 mm	4,25 mm
01	6,50 mm	4,25 mm
79	5,00 mm	3,30 mm
31	6,50 mm	3,30 mm

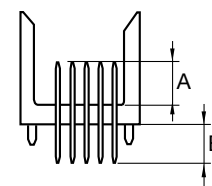

**Note:** for other special patterns or loadings, please check drawings, all other configurations on request only

## Header, 5 row, signal, straight, press-fit, wide body

### FEATURES

- In accordance with IEC 60917 and IEC 61076-4-104 (Futurebus+).
- 5 Rows and 2 mm pitch permit high signal density (200 contacts per 100 mm connector length).
- Stackable end-to-end without loss of positions.
- Stackable with other METRAL™ function modules (e.g. power, coax, guide pin).
- First Make Last Break options.
- Eye the needle press-fit contact

### TECHNICAL DATA

#### PHYSICAL

- spacing: 2,00 mm x 2,00 mm
- housing: glass-filled LCP, colour natural
- flammability rating: UL 94 V-0
- pin material: phosphor bronze
- performance level: Telcordia CO

#### ELECTRICAL

- current rating: 1 A
- insulation resistance:  $5 \times 10^3 \text{ M}\Omega$  initially,  $1 \times 10^3 \text{ M}\Omega$  after tests
- withstanding voltage: 1000 V rms (sea level)

#### MECHANICAL PERFORMANCE

- insertion force: 0,45 N max. per individual signal contact (mating)
- withdrawal force: 0,15 N max. per individual signal contact (unmating)
- press-fit contact insertion: 65 N max. per pin
- press-fit pin withdrawal: 15 N min. per pin
- recommended hole diameter: 0,65-0,80 mm

#### ENVIRONMENTAL

- Operating temperature range:  $-55^\circ\text{C}$  to  $+125^\circ\text{C}$
- RoHs information, this product is compatible according to the European Union Directive 2002/95/IEC

#### PACKAGING

- standard: tubes

#### PROCESSING INFORMATION

- press fit

#### REFERENCE DATA

- product specification.: GS-12-180

#### APPLICATION EQUIPMENT

- for application equipment, check out the application equipment table on page 217-223



### MATING DATA

#### ■ Receptacle, right angle, press-fit, page 45

- 1 mod – part number 89047-102LF
- 2 mod – part number 89093-102LF
- 4 mod – part number 89094-102LF
- 8 mod – part number 89095-102LF

#### ■ Receptacle, right angle, solder-to-board, page 43

- 1 mod – part numbers 85863-102LF
- 2 mod – part numbers 85864-102LF
- 4 mod – part numbers 85865-102LF
- 8 mod - part numbers 85866-102LF

### TYPICAL APPLICATIONS

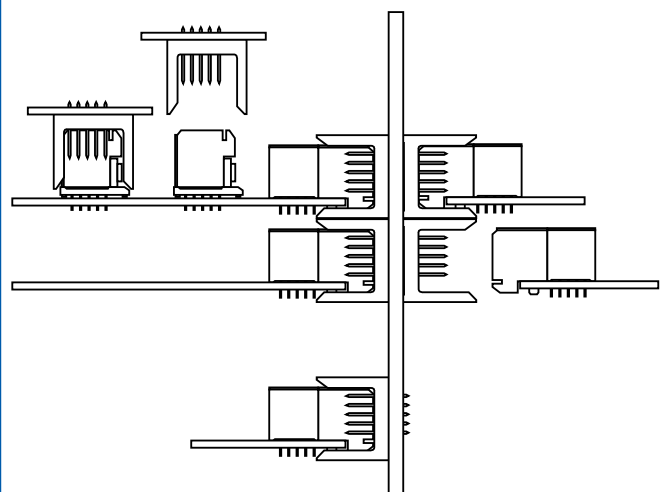

# Header, 5 row, signal, straight, press-fit, wide body

## PRODUCT

1 Module  
89006-1yyLF

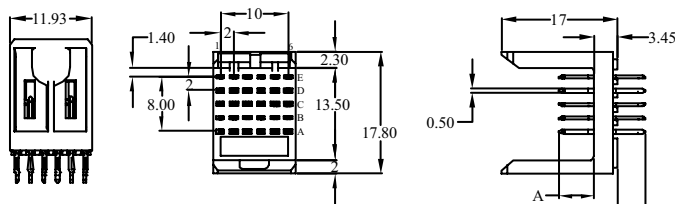

2 Module  
89007-1yyLF

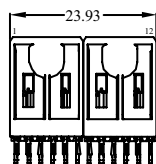

4 Module  
89008-1yyLF

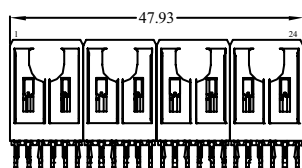

8 Module  
89009-1yyLF

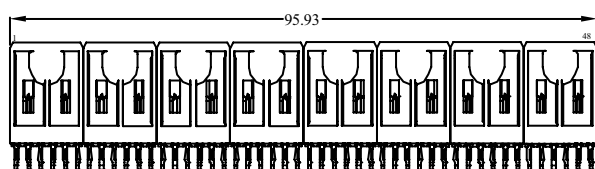

PCB pattern P7, see chapter PCB layouts

## PARTNUMBERS

8900x - 1yyLF



- 89006** = 1 module (5 x 6 pos.)
- 89007** = 2 module (5 x 12 pos.)
- 89008** = 4 module (5 x 24 pos.)
- 89009** = 8 module (5 x 48 pos.)

**1** = Telcordia CO

**LF** = lead free

yy	mating length (A)	tail length (B)
<b>11</b>	5,00 mm	4,30 mm
<b>16</b>	5,75 mm	4,30 mm
<b>15</b>	6,50 mm	4,30 mm
<b>21</b>	5,00 mm	13,60 mm
<b>26</b>	5,75 mm	13,60 mm
<b>25</b>	6,50 mm	13,60 mm
first-make last-brake <b>44</b>	row A = 5,00 mm	4,30 mm
	row B = 6,50 mm	4,30 mm
	row C = 7,25 mm	4,30 mm
	row D = 6,50 mm	4,30 mm
	row E = 5,00 mm	4,30 mm

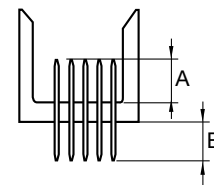

**Note:** blue marked in **pin configuration** is the preferred recommended standard for other special patterns or loadings, please check drawings, all other configurations on request only

## Receptacle, 5 row, signal, right angle, solder to board

### FEATURES

- In accordance with IEC 60917 and IEC 61076-4-104 (Futurebus+)
- 5 row and 2 mm pitch permit high signal density (250 contacts per 100 mm connector length)
- Modular design guarantees flexibility
- Stackable end-to-end without loss of position
- Stackable with other METRAL® function modules (power, I/O)
- Reliable dual beam box contact
- Stable PCB fixation device

### TECHNICAL DATA

#### PHYSICAL

- spacing: 2,00 mm x 2,00 mm
- housing: glass-filled LCP, colour natural
- flammability rating: UL 94 V-0
- contact material: phosphor bronze
- performance level: Telcordia CO

#### ELECTRICAL

- current rating: 1 A
- insulation resistance:  $5 \times 10^3 \text{ M}\Omega$  initially,  $1 \times 10^3 \text{ M}\Omega$  after tests
- withstanding voltage: 1000 V rms (sea level)

#### MECHANICAL PERFORMANCE

- insertion force: 0,45 N max. per individual signal contact (mating)
- withdrawal force: 0,15 N max. per individual signal contact (unmating)
- Recommended hole diameter: 0,65 – 0,80 mm

#### ENVIRONMENTAL

- Operating temperature range:  $-55^\circ\text{C}$  to  $+125^\circ\text{C}$
- RoHs information, this product is compatible according to the European Union Directive 2002/95/IEC

#### PACKAGING

- standard: tubes

#### PROCESSING INFORMATION

- Applicable process: wave, IR, vapor phase

#### REFERENCE DATA

- Press-peg application, TA-0941
- product specification.: GS-12-453

#### APPLICATION EQUIPMENT

- for application equipment, check out the application equipment table on page 217-223

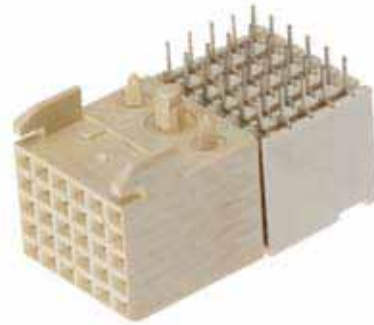

### MATING DATA

#### Header straight, press-fit, page 41

- 1 module – part number 89006-116LF
- 2 modules – part number 89007-116LF
- 4 modules – part number 89008-116LF
- 8 modules – part number 89009-116LF

#### Header straight, solder-to-board, page 39

- 1 module – part number 74741-101LF
- 2 modules – *on request only*
- 4 modules – *on request only*
- 8 modules – *on request only*

### TYPICAL APPLICATIONS

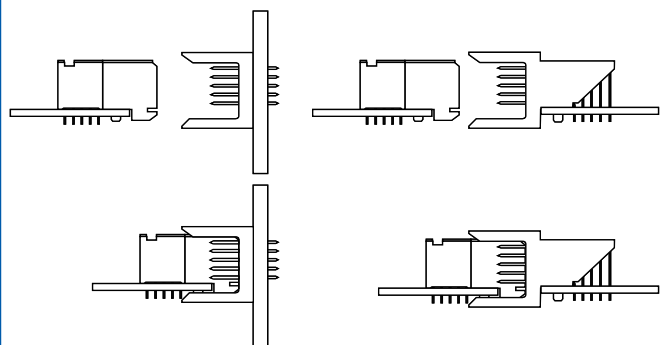



# Receptacle, 5 row, signal, right angle, solder to board

## PRODUCT

1 Module  
85863-1yyLF

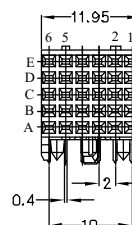
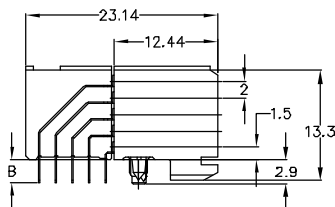
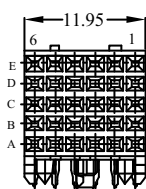

2 Module  
85864-1yyLF

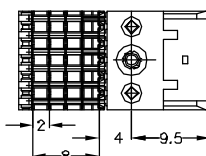
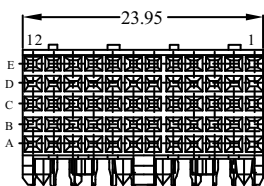

4 Module  
85865-1yyLF

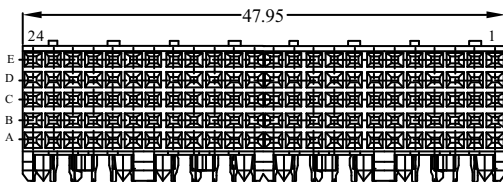

8 Module  
85866-1yyLF

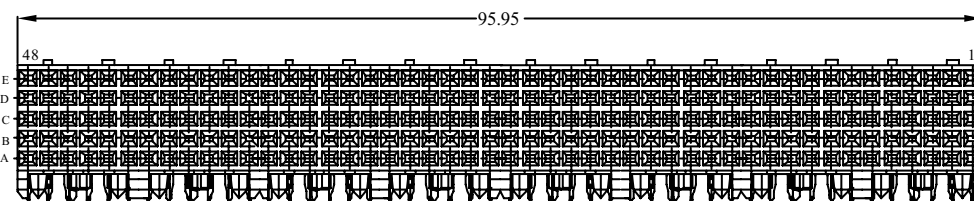

PCB pattern P2, see chapter PCB layouts

## PARTNUMBERS

8586x - 1yyLF

Base Part Number

Performance

Pin Configuration

LF

85863 = 1 module (5 x 6 pos.)

85864 = 2 module (5 x 12 pos.)

85865 = 4 module (5 x 24 pos.)

85866 = 8 module (5 x 48 pos.)

1 = Telcordia CO

LF = lead free

yy	tail length (B)	PCB thickness
02	2,90 mm	1,60 mm
12	3,53 mm	2,40 mm

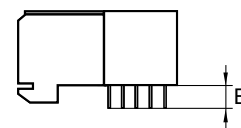

## Receptacle, 5 row, signal, right angle, press fit

### FEATURES

- In accordance with IEC 60917 and IEC 61076-4-104 (Futurebus+)
- 5 row and 2 mm pitch permit high signal density (250 contacts per 100 mm connector length)
- Modular design guarantees flexibility
- Stackable end-to-end without loss of position
- Stackable with other METRAL® function modules (power, I/O)
- Reliable dual beam box contact
- Stable PCB fixation device
- Press block ensures accurate position of press-fit tails for easy mounting
- Eye the needle press-fit contact



### TECHNICAL DATA

#### PHYSICAL

- spacing: 2,00 mm x 2,00 mm
- housing: glass-filled LCP, colour natural
- flammability rating: UL 94 V-0
- contact material: phosphor bronze
- performance level: Telcordia CO

#### ELECTRICAL

- current rating: 1 A
- insulation resistance: 5x10<sup>3</sup> MΩ initially, 1x10<sup>3</sup> MΩ after tests
- withstanding voltage: 1000 V rms (sea level)

#### MECHANICAL PERFORMANCE

- insertion force: 0,45 N max. per individual signal contact (mating)
- withdrawal force: 0,15 N max. per individual signal contact (unmating)
- press-fit contact insertion: 55 N max. per pin
- press-fit pin withdrawal: 15 N min. per pin
- recommended hole diameter: 0,65-0,80 mm

#### ENVIRONMENTAL

- Operating temperature range: -55°C to +125°C
- RoHs information, this product is compatible according to the European Union Directive 2002/95/IEC

#### PACKAGING

- standard: tubes

#### PROCESSING INFORMATION

- press fit

#### REFERENCE DATA

- Press-peg application, TA-0941
- product specification.: GS-12-453

#### APPLICATION EQUIPMENT

- for application equipment, check out the application equipment table on page 217-223.

### MATING DATA

#### Header straight, press-fit, page 41

- 1 module – part number 89006-116LF
- 2 modules – part number 89007-116LF
- 4 modules – part number 89008-116LF
- 8 modules – part number 89009-116LF

#### Header straight, solder-to-board, page 39

- 1 module – part number 74741-101LF
- 2 modules – *on request only*
- 4 modules – *on request only*
- 8 modules – *on request only*

### TYPICAL APPLICATIONS

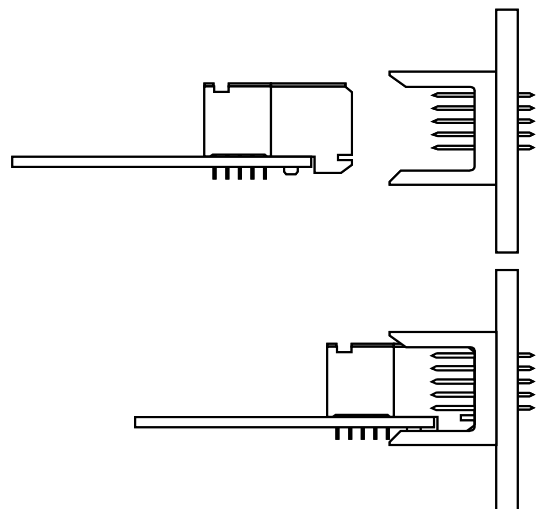

# Receptacle, 5 row, signal, right angle, press fit

## PRODUCT

1 Module  
89047-1yyLF

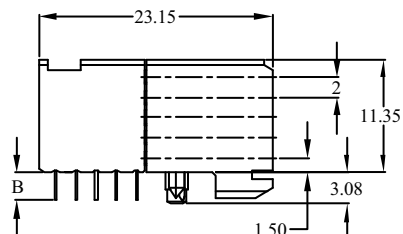
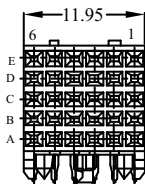

2 Module  
89093-1yyLF

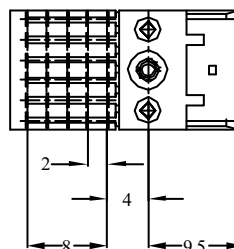
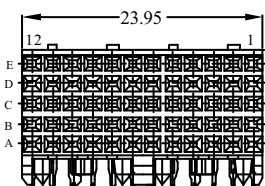

4 Module  
89094-1yyLF

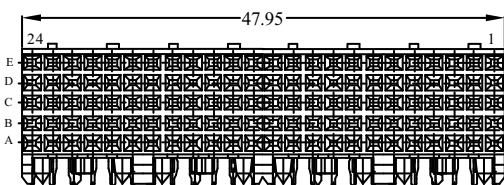

8 Module  
89095-1yyLF

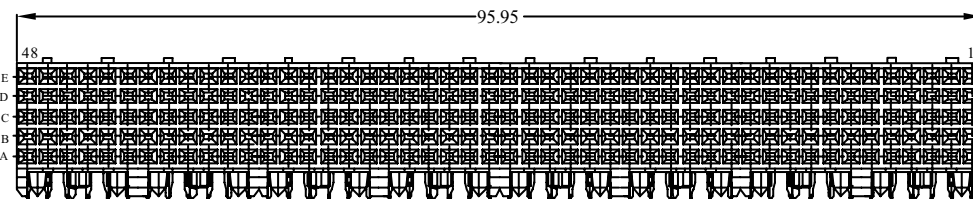

PCB pattern P2, see chapter PCB layouts

## PARTNUMBERS

8904x - 1yyLF

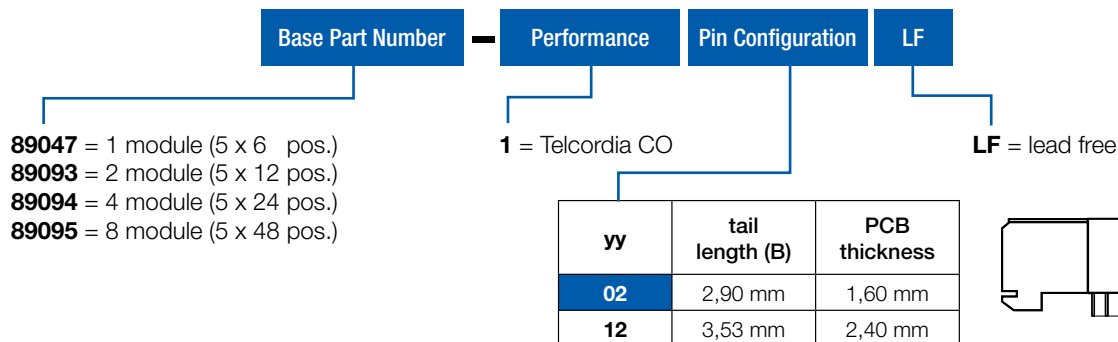

**Note:** blue marked in **pin configuration** is the preferred recommended standard  
for other special patterns or loadings, please check drawings, all other configurations on request only

## Receptacle, 5 row, signal, right angle, pin-in-paste

### FEATURES

- In accordance with IEC 60917 and IEC 61076-4-104 (Futurebus+)
- 5 row and 2 mm pitch permit high signal density, 1 module (5 x 6 positions)
- Modular design guarantees flexibility
- Stackable end-to-end without loss of position
- Stackable with other METRAL® function modules (power, I/O)
- Tuning fork, forced controlled contact
- Stable PCB fixation device
- Low profile allows PCB spacing of 14mm



### TECHNICAL DATA

#### PHYSICAL

- spacing: 2,00 mm x 2,00 mm
- housing: glass-filled LCP (30% glass), colour natural
- flammability rating: UL 94 V-0
- contact material: phosphor bronze
- performance level: Telcordia CO

#### ELECTRICAL

- current rating: 1 A
- insulation resistance:  $5 \times 10^3 \text{ M}\Omega$  initially,  $1 \times 10^3 \text{ M}\Omega$  after tests
- withstanding voltage: 1000 V rms (sea level)

#### MECHANICAL PERFORMANCE

- Maximum mounting force, 20 N per connector
- insertion force: 0,45 N max. per individual signal contact (mating)
- withdrawal force: 0,15 N max. per individual signal contact (unmating)
- Recommended hole diameter: 0,65 – 0,80 mm

#### ENVIRONMENTAL

- Operating temperature -55°C to + 125°C
- Max. temperature 260°C for 30 seconds
- RoHs information, this product is compatible according to the European Union Directive 2002/95/IEC

#### PACKAGING

- Tape&reel

#### PROCESSING INFORMATION

- Pick&place by vacuum nozzle or mechanical gripper
- automatic Surface-mount reflow process, resistance for Lead Free reflow temperature

#### REFERENCE DATA

- Product specification GS-12-215

#### APPLICATION EQUIPMENT

- for application equipment, check out the application equipment table on page 217-223

### MATING DATA

- Header, straight, press-fit, page 41

- 1 module – part number 89006-116LF

- Header, straight, solder-to-board, page 39

- 1 module – part number 74741-101LF

### TYPICAL APPLICATIONS

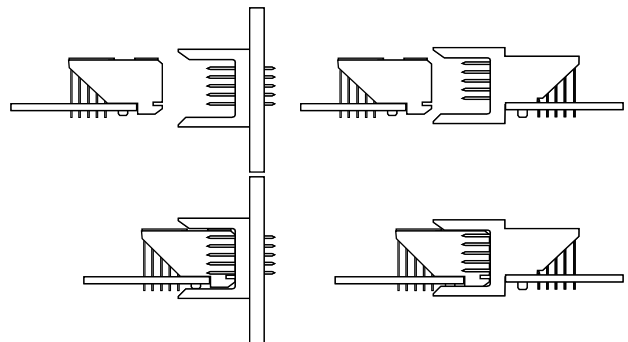

# Receptacle, 5 row, signal, right angle, pin-in-paste

## PRODUCT

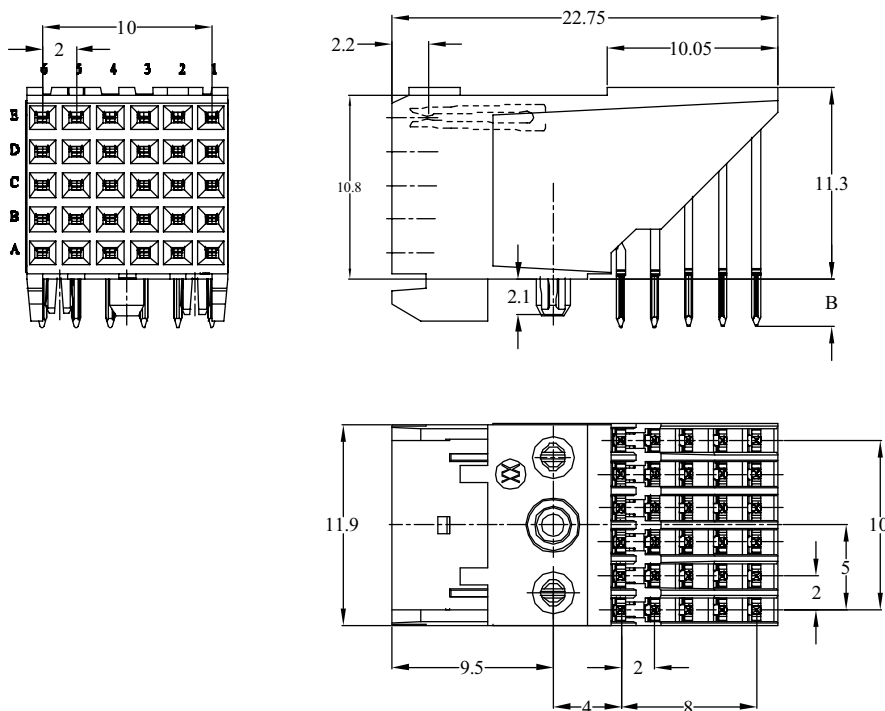

PCB pattern P2, see chapter PCB layouts

## PARTNUMBERS

52049 - 101LF

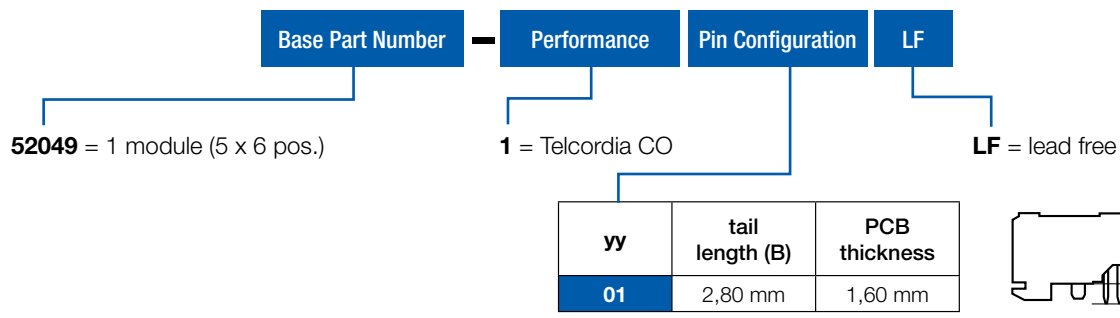

**Note:** blue marked in **pin configuration** is the preferred recommended standard for other special patterns or loadings, please check drawings, all other configurations on request only

## Header, 8 row, signal, straight, press fit, wide body

### FEATURES

- In accordance with IEC 60917 and IEC 61076-4-104 (Futurebus+)
- 8 row and 2 mm pitch permit high signal density ( 800 contacts per 100mm connector length)
- 2 modules header, 8 rows by 6 position
- Baby H-shape press-fit contact

### TECHNICAL DATA

#### PHYSICAL

- spacing: 2,00 mm x 2,00 mm
- housing: glass-filled LCP, colour natural
- flammability rating: UL 94 V-0
- pin material: phosphor bronze
- performance level: Telcordia CO

#### ELECTRICAL

- current rating: 1 A
- insulation resistance:  $5 \times 10^3 \text{ M}\Omega$  initially,  $1 \times 10^3 \text{ M}\Omega$  after tests
- withstanding voltage: 1000 V rms (sea level)

#### MECHANICAL PERFORMANCE

- insertion force: 0,45 N max. per individual signal contact (mating)
- withdrawal force: 0,15 N max. per individual signal contact (unmating)

- press-fit contact insertion: 65 N max. per pin
- press-fit pin withdrawal: 15 N min. per pin
- recommended hole diameter: 0,65-0,80 mm

#### ENVIRONMENTAL

- Operating temperature range:  $-55^\circ\text{C}$  to  $+125^\circ\text{C}$
- RoHs information, this product is compatible according to the European Union Directive 2002/95/IEC

#### PACKAGING

- standard: tubes

#### PROCESSING INFORMATION

- press fit

#### REFERENCE DATA

- product specification.: GS-12-134
- application specification: GS-20-010

#### APPLICATION EQUIPMENT

- for application equipment, check out the application equipment table on page 217-223



### MATING DATA

- Receptacle, right angle, press-fit, page 51
- part number 74770-102LF

### TYPICAL APPLICATIONS

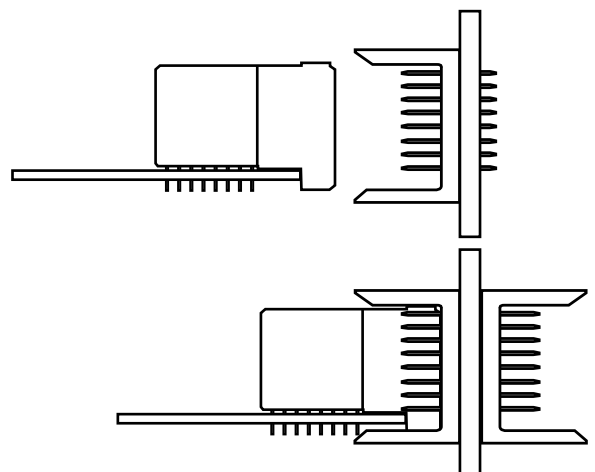

# Header, 8 row, signal, straight, press fit, wide body

## PRODUCT

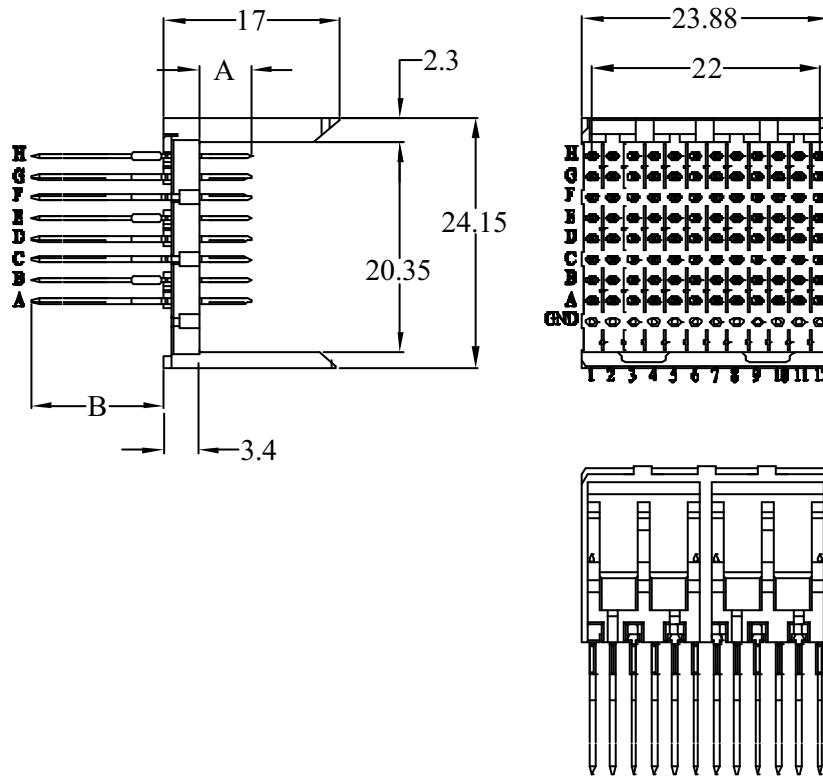

PCB pattern P21, see chapter PCB layouts

## PARTNUMBERS

74771 - 102011LF

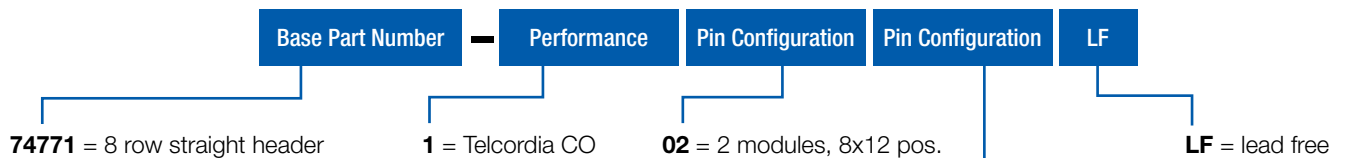

yyy	mating length (A)	tail length (B)
011	6,50 mm	17,10 mm

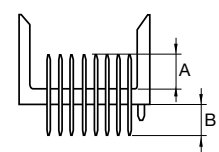

**Note:** blue marked in **pin configuration** is the preferred recommended standard for other special patterns or loadings, please check drawings, all other configurations on request only

## Receptacle, 8 row, signal, right angle, press fit

### FEATURES

- In accordance with IEC 60917 and IEC 61076-4-104 (Futurebus+)
- 8 row and 2 mm pitch permit high signal density ( 800 contacts per 100mm connector length)
- 2 modules header, 8 rows by 6 position
- Eye of the needle press-fit contact
- Tuning fork, forced controlled contact

### TECHNICAL DATA

#### PHYSICAL

- spacing: 2,00 mm x 2,00 mm
- housing: glass-filled LCP, colour natural
- flammability rating: UL 94 V-0
- pin material: phosphor bronze
- performance level: Telcordia CO

#### ELECTRICAL

- current rating: 1 A
- insulation resistance:  $5 \times 10^3 \text{ M}\Omega$  initially,  $1 \times 10^3 \text{ M}\Omega$  after tests
- withstanding voltage: 1000 V rms (sea level)

#### MECHANICAL PERFORMANCE

- insertion force: 0,45 N max. per individual signal contact (mating)
- withdrawal force: 0,15 N max. per individual signal contact (unmating)
- press-fit contact insertion: 55 N max. per pin
- press-fit pin withdrawal: 15 N min. per pin
- recommended hole diameter: 0,65-0,80 mm

#### ENVIRONMENTAL

- Operating temperature range:  $-55^\circ\text{C}$  to  $+125^\circ\text{C}$
- RoHs information, this product is compatible according to the European Union Directive 2002/95/IEC

#### PACKAGING

- standard: tubes

#### PROCESSING INFORMATION

- press fit

#### REFERENCE DATA

- product spec.: GS-12-134
- application specification: GS-20-010

#### APPLICATION EQUIPMENT

- for application equipment, check out the application equipment table on page 217-223



### MATING DATA

- Receptacle, right angle, press-fit, page 49
- part number 74771-102011LF

### TYPICAL APPLICATIONS

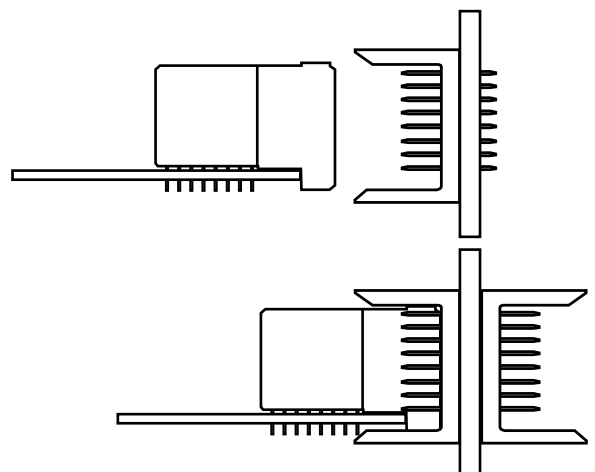



# Receptacle, 8 row, signal, right angle, press fit

## PRODUCT

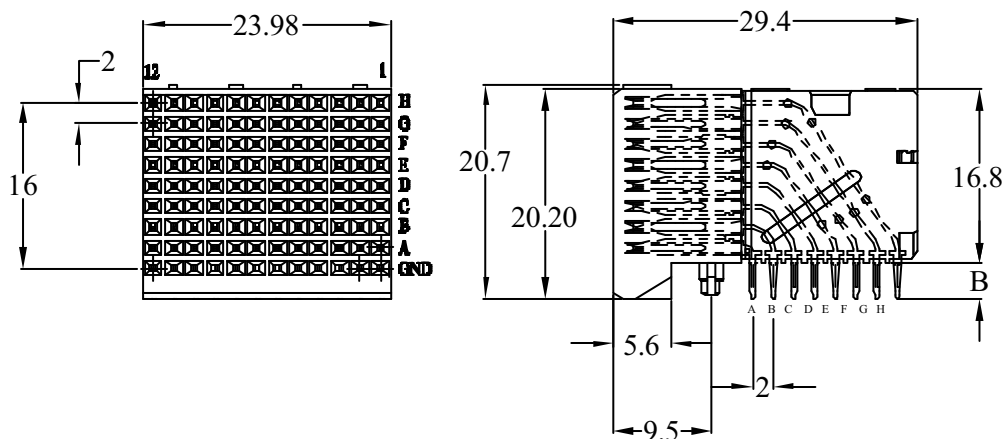

PCB pattern P22, see chapter PCB layouts

## PARTNUMBERS

74770 - 102LF

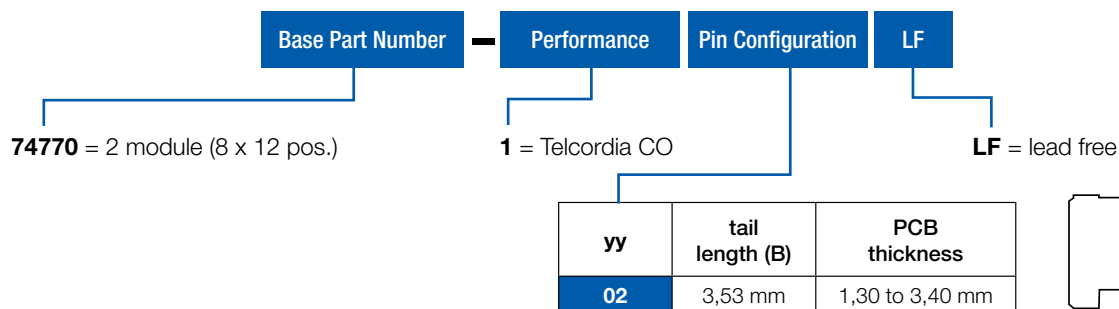







**Note:** blue marked in **pin configuration** is the preferred recommended standard for other special patterns or loadings, please check drawings, all other configurations on request only





## METRAL® SIGNAL CONNECTORS REVERSED

-  Header, 4 row, right angle, wide body
-  Header, 4 row, right angle, narrow body
-  Receptacle, 4 row, straight
-  Header, 5 row, right angle, wide body
-  Header, 5 row, right angle, narrow body
-  Receptacle, 4 row, straight

# Header, 4 row, signal, right angle, solder to board, wide body

## FEATURES

- In accordance with IEC 60917 and IEC 61076-4-104 (Futurebus+)
- 4 row and 2 mm pitch permit high signal density ( 200 contacts per 100mm connector length)
- Modular design guarantees flexibility



## TECHNICAL DATA

### PHYSICAL

- spacing: 2,00 mm x 2,00 mm
- housing: glass-filled LCP, colour natural
- flammability rating: UL 94 V-0
- pin material: phosphor bronze
- performance level: Telcordia CO

### ELECTRICAL

- current rating: 1 A
- insulation resistance: 5x10<sup>3</sup> MΩ initially, 1x10<sup>3</sup> MΩ after tests
- withstanding voltage: 1000 V rms (sea level)

### MECHANICAL PERFORMANCE

- insertion force: 0,45 N max. per individual signal contact (mating)
- withdrawal force: 0,15 N max. per individual signal contact (unmating)
- recommended hole diameter: 0,65-0,80 mm

### ENVIRONMENTAL

- Operating temperature range: -55°C to +125°C
- RoHs information, this product is compatible according to the European Union Directive 2002/95/IEC

### PACKAGING

- standard: trays

### PROCESSING INFORMATION

- applicable soldering process: wave, IR, vapor phase

### REFERENCE DATA

- Product specification: GS-12-446

### APPLICATION EQUIPMENT

- for application equipment, check out the application equipment table on page 217-223

## MATING DATA

### Receptacle, straight, press-fit, page 69

- 1 mod – part number 85757-1101LF
- 2 mod – part number 85758-1101LF
- 4 mod – part number 85759-1101LF
- 8 mod – part number 85760-1101LF

### Receptacle, straight, solder-to-board, page 67

- 1 mod – part numbers HM1S41FRR000H6PLF
- 2 mod – part numbers HM1S42FRR000H6PLF
- 4 mod – part numbers HM1S43FRR000H6PLF
- 8 mod - part numbers HM1S44FRR000H6PLF

## TYPICAL APPLICATIONS

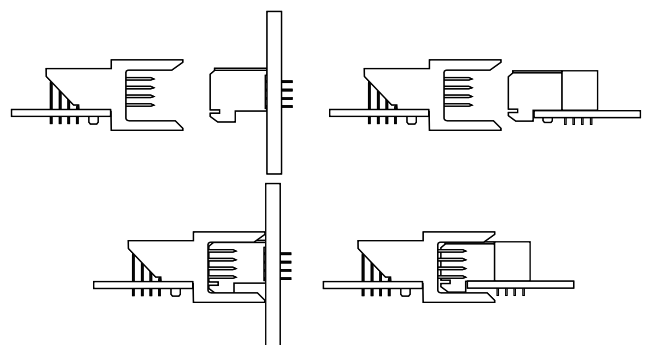

# Header, 4 row, signal, right angle, solder to board, wide body

## PRODUCT

### 1 Module

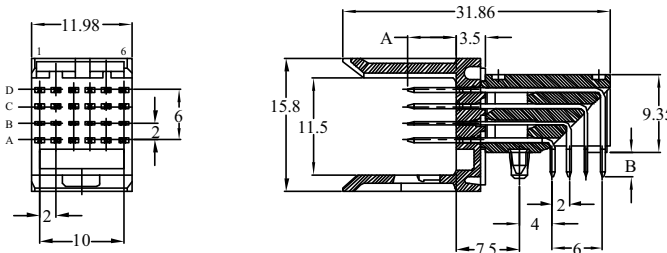

### 2 Module

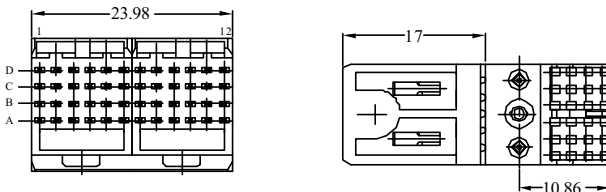

### 4 Module

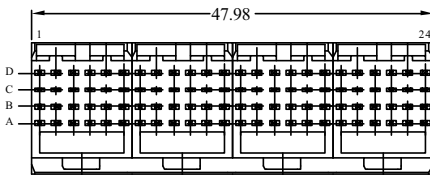

### 8 Module

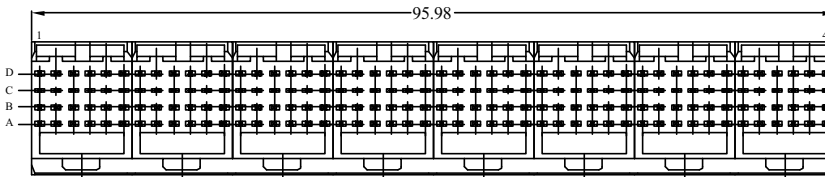

PCB pattern P1, see chapter PCB layouts

## PARTNUMBERS

HM1L4 x LAP000H6PLF

Base Part Number	Type	no. of rows	no. of pos.	Configuration	000	Performance	Packaging	LF
HM1	L = Signal header right angle, wide body	4 = 4 row		LAP = solder to board		H6 = Telcordia CO		LF = lead free
							P = trays	

mating length (A)	tail length (B)
5,75 mm	2,90 mm
1,6 mm PCB thickness	

**Note:** For other special patterns or loadings, please check drawings, all other configurations on request only

## Header, 4 row, signal, right angle, press fit, wide body

### FEATURES

- In accordance with IEC 60917 and IEC 61076-4-104 (Futurebus+)
- 4 row and 2 mm pitch permit high signal density ( 200 contacts per 100mm connector length)
- Modular design guarantees flexibility
- Eye of the needle press-fit contact

### TECHNICAL DATA

#### PHYSICAL

- spacing: 2,00 mm x 2,00 mm
- housing: glass-filled LCP, colour natural
- flammability rating: UL 94 V-0
- pin material: phosphor bronze
- performance level: Telcordia CO

#### ELECTRICAL

- current rating: 1 A
- insulation resistance: 5x10<sup>3</sup> MΩ initially, 1x10<sup>3</sup> MΩ after tests
- withstanding voltage: 1000 V rms (sea level)

#### MECHANICAL PERFORMANCE

- insertion force: 0,45 N max. per individual signal contact (mating)
- withdrawal force: 0,15 N max. per individual signal contact (unmating)
- press-fit contact insertion: 55 N max. per pin
- press-fit pin withdrawal: 15 N min. per pin
- recommended hole diameter: 0,65-0,80 mm

#### ENVIRONMENTAL

- Operating temperature range: -55°C to +125°C
- RoHs information, this product is compatible according to the European Union Directive 2002/95/IEC

#### PACKAGING

- standard: trays

#### PROCESSING INFORMATION

- press-fit

#### REFERENCE DATA

- Product specification: GS-12-445

#### APPLICATION EQUIPMENT

- for application equipment, check out the application equipment table on page 217-223



### MATING DATA

#### ■ Receptacle, press-fit, page 69

- 1 mod – part number 85757-1101LF
- 2 mod – part number 85758-1101LF
- 4 mod – part number 85759-1101LF
- 8 mod – part number 85760-1101LF

#### ■ Receptacle, solder-to-board, page 67

- 1 mod – part numbers HM1S41FRR000H6PLF
- 2 mod – part numbers HM1S42FRR000H6PLF
- 4 mod – part numbers HM1S43FRR000H6PLF
- 8 mod - part numbers HM1S44FRR000H6PLF

### TYPICAL APPLICATIONS

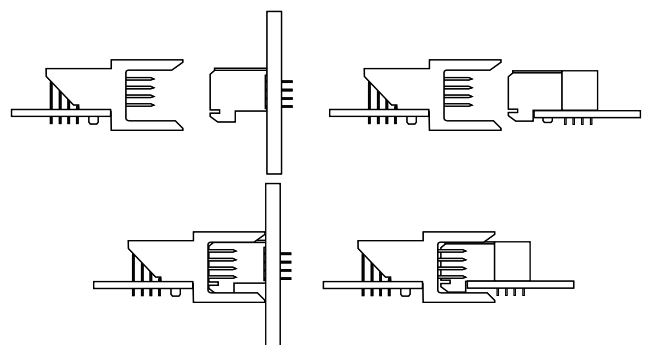

# Header, 4 row, signal, right angle, press fit, wide body

## PRODUCT

### 1 Module

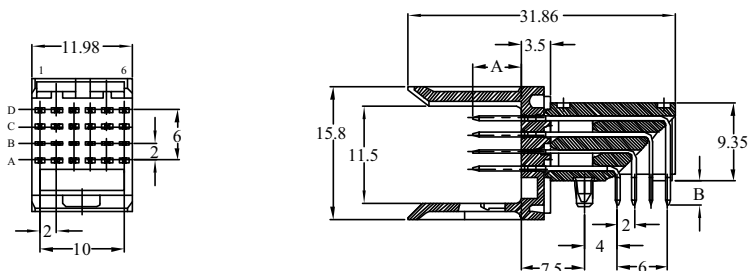

### 2 Module

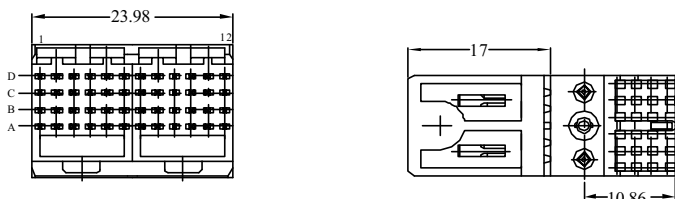

### 4 Module

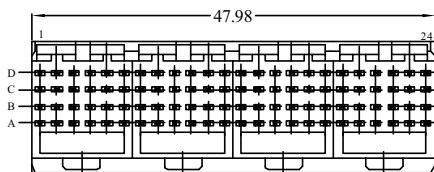

### 8 Module

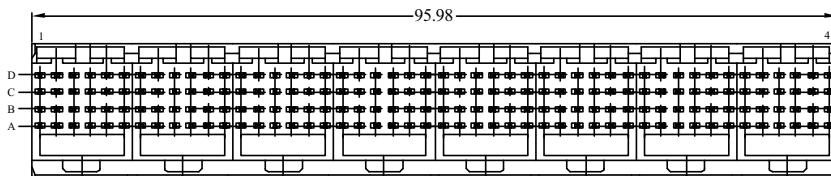

PCB pattern P1, see chapter PCB layouts

## PARTNUMBERS

HM1L4 x LDP000H6PLF

Base Part Number	Type	no. of rows	no. of pos.	Configuration	000	Performance	Packaging	LF						
HM1	L = Signal header right angle, wide body	4 = 4 row	LDP = Press fit	<table border="1"> <thead> <tr> <th>mating length (A)</th> <th>tail length (B)</th> </tr> </thead> <tbody> <tr> <td>5,75 mm</td> <td>2,90 mm</td> </tr> <tr> <td colspan="2">1,6 mm PCB thickness</td> </tr> </tbody> </table>	mating length (A)	tail length (B)	5,75 mm	2,90 mm	1,6 mm PCB thickness			H6 = Telcordia CO	P = trays	LF = lead free
mating length (A)	tail length (B)													
5,75 mm	2,90 mm													
1,6 mm PCB thickness														
		1 = 1 module (4 x 6 pos.) 2 = 2 module (4 x 12 pos.) 3 = 4 module (4 x 24 pos.) 4 = 8 module (4 x 48 pos.)												

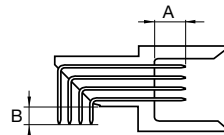

**Note:** for other special patterns or loadings, please check drawings, all other configurations on request only

## Header, 4 row, signal, right angle, pin-in-paste, wide body

### FEATURES

- In accordance with IEC 60917 and IEC 61076-4-104 (Futurebus+)
- 4 row and 2 mm pitch permit high signal density ( 200 contacts per 100mm connector length)
- Modular design guarantees flexibility

### TECHNICAL DATA

#### PHYSICAL

- spacing: 2,00 mm x 2,00 mm
- housing: glass-filled LCP, colour natural
- flammability rating: UL 94 V-0
- pin material: phosphor bronze
- performance level: Telcordia CO

#### ELECTRICAL

- current rating: 1 A
- insulation resistance:  $5 \times 10^3 \text{ M}\Omega$  initially,  $1 \times 10^3 \text{ M}\Omega$  after tests
- withstanding voltage: 1000 V rms (sea level)

#### MECHANICAL PERFORMANCE

- insertion force: 0,45 N max. per individual signal contact (mating)
- withdrawal force: 0,15 N max. per individual signal contact (unmating)
- recommended hole diameter: 0,65-0,80 mm

#### ENVIRONMENTAL

- Operating temperature range:  $-55^\circ\text{C}$  to  $+125^\circ\text{C}$
- RoHs information, this product is compatible according to the European Union Directive 2002/95/IEC

#### PACKAGING

- standard: trays

#### PROCESSING INFORMATION

- Pick&place by vacuum nozzle or mechanical gripper
- automatic Surface-mount reflow process, resistance for Lead Free reflow temperature

#### REFERENCE DATA

- Product specification: GS-12-446

#### APPLICATION EQUIPMENT

- for application equipment, check out the application equipment table on page 217-223



### MATING DATA

- Receptacle, straight, press-fit, page 69
  - 1 mod – part number 85757-101LF
- Receptacle, straight, solder-to-board, page 67
  - 1 mod – part numbers HM1S41FRR000H6PLF

### TYPICAL APPLICATIONS

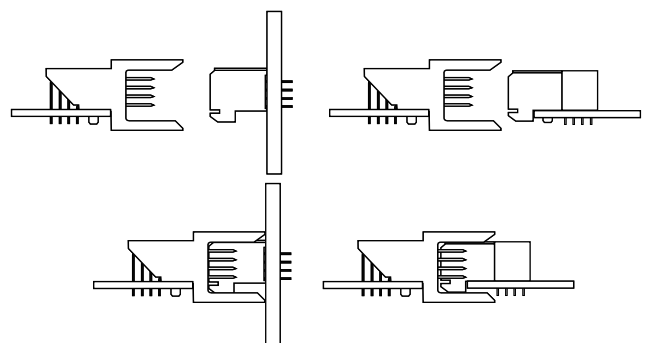



# Header, 4 row, signal, right angle, pin-in-paste, wide body

## PRODUCT

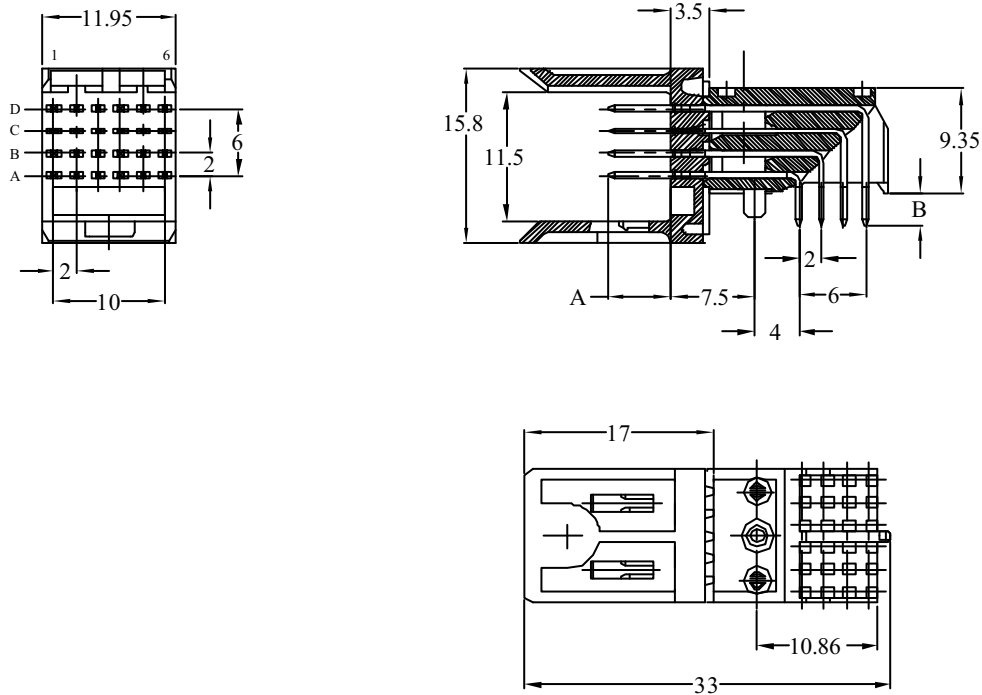

PCB pattern P1, see chapter PCB layouts

## PARTNUMBERS

**HM1L4 x LFP000H6PLF**

Base Part Number	Type	no. of rows	no. of pos.	Configuration	000	Performance	Packaging	LF						
<b>HM1</b>	<b>L</b> = Signal header right angle, wide body	<b>4</b> = 4 row	<b>1</b> = 1 module (4 x 6 pos.)	<b>LFP</b> = Pin-in-Paste <table border="1"> <thead> <tr> <th>mating length (A)</th> <th>tail length (B)</th> </tr> </thead> <tbody> <tr> <td>5,75 mm</td> <td>2,90 mm</td> </tr> <tr> <td colspan="2">1,6 mm PCB thickness</td> </tr> </tbody> </table>	mating length (A)	tail length (B)	5,75 mm	2,90 mm	1,6 mm PCB thickness			<b>H6</b> = Telcordia CO	<b>P</b> = trays	<b>LF</b> = lead free
mating length (A)	tail length (B)													
5,75 mm	2,90 mm													
1,6 mm PCB thickness														

**Note:** for other special patterns or loadings, please check drawings, all other configurations on request only

# Header, 4 row, signal, right angle, solder to board, narrow body

## FEATURES

- In accordance with IEC 60917 and IEC 61076-4-104 (Futurebus+)
- 4 row and 2 mm pitch permit high signal density ( 200 contacts per 100mm connector length)
- Modular design guarantees flexibility
- Narrow body housing

## TECHNICAL DATA

### PHYSICAL

- spacing: 2,00 mm x 2,00 mm
- housing: glass-filled LCP, colour natural
- flammability rating: UL 94 V-0
- pin material: phosphor bronze
- performance level: Telcordia CO

### ELECTRICAL

- current rating: 1 A
- insulation resistance: 5x10<sup>3</sup> MΩ initially, 1x10<sup>3</sup> MΩ after tests
- withstanding voltage: 1000 V rms (sea level)

### MECHANICAL PERFORMANCE

- insertion force: 0,45 N max. per individual signal contact (mating)
- withdrawal force: 0,15 N max. per individual signal contact (unmating)
- recommended hole diameter: 0,65-0,80 mm

### ENVIRONMENTAL

- Operating temperature range: -55°C to +125°C
- RoHs information, this product is compatible according to the European Union Directive 2002/95/IEC

### PACKAGING

- standard: tubes

### PROCESSING INFORMATION

- applicable soldering process: wave, IR, vapor phase

### REFERENCE DATA

- Product specification: GS-12-446

### APPLICATION EQUIPMENT

- for application equipment, check out the application equipment table on page 217-223

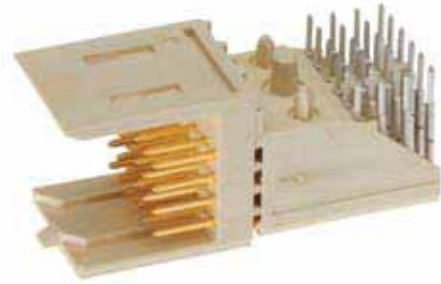

## MATING DATA

- Receptacle, straight, press-fit, page 69
  - 1 mod – part number 85757-1101LF
- Receptacle, straight, solder-to-board, page 67
  - 1 mod – part numbers HM1S41FRR000H6PLF

## TYPICAL APPLICATIONS

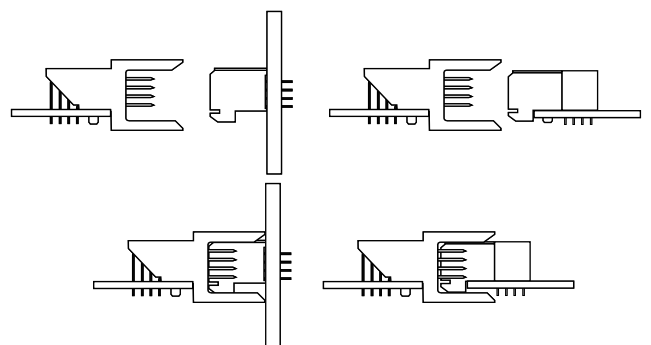

# Header, 4 row, signal, right angle, solder to board, narrow body

## PRODUCT

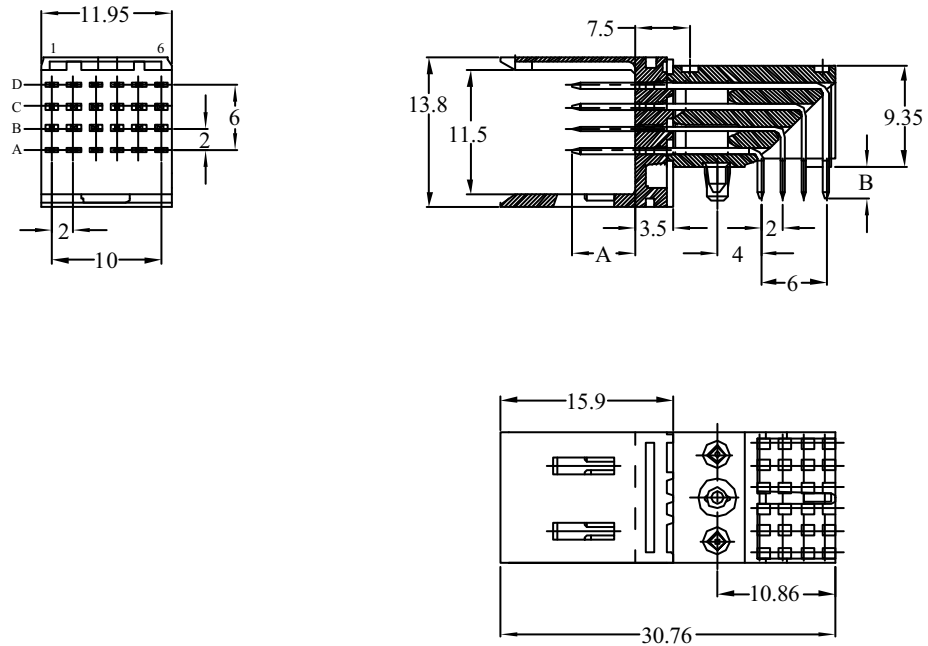

PCB pattern P1, see chapter PCB layouts

## PARTNUMBERS

85822 - 1yyLF

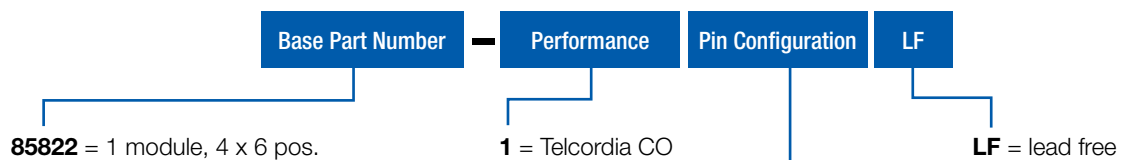

yy	mating length (A)	tail length (B)
01	5,00 mm	2,90 mm
05	5,75 mm	2,90 mm
10	5,75 mm	3,70 mm

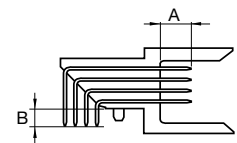

**Note:** for other special patterns or loadings, please check drawings, all other configurations on request only

## Header, 4 row, signal, right angle, press fit, narrow body

### FEATURES

- In accordance with IEC 60917 and IEC 61076-4-104 (Futurebus+)
- 5 row and 2 mm pitch permit high signal density ( 250 contacts per 100mm connector length)
- Modular design guarantees flexibility
- Narrow body housing
- Eye of the needle press-fit contact

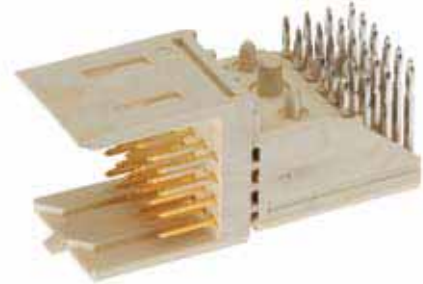

### TECHNICAL DATA

#### PHYSICAL

- spacing: 2,00 mm x 2,00 mm
- housing: glass-filled LCP, colour natural
- flammability rating: UL 94 V-0
- pin material: phosphor bronze
- performance level: Telcordia CO

#### ELECTRICAL

- current rating: 1 A
- insulation resistance:  $5 \times 10^3 \text{ M}\Omega$  initially,  $1 \times 10^3 \text{ M}\Omega$  after tests
- withstanding voltage: 1000 V rms (sea level)

#### MECHANICAL PERFORMANCE

- insertion force: 0,45 N max. per individual signal contact (mating)
- withdrawal force: 0,15 N max. per individual signal contact (unmating)
- press-fit contact insertion: 55 N max. per pin
- press-fit pin withdrawal: 15 N min. per pin
- recommended hole diameter: 0,65-0,80 mm

#### ENVIRONMENTAL

- Operating temperature range: -55°C to +125°C
- RoHs information, this product is compatible according to the European Union Directive 2002/95/IEC

#### PACKAGING

- standard: tubes

#### PROCESSING INFORMATION

- press fit

#### REFERENCE DATA

- Product specification: GS-12-445

#### APPLICATION EQUIPMENT

- for application equipment, check out the application equipment table on page 217-223

### MATING DATA

- Receptacle, straight, press-fit, page 69
  - 1 mod – part number 85757-1101LF
- Receptacle, straight, solder-to-board, page 67
  - 1 mod – part numbers HM1S41FRR000H6PLF

### TYPICAL APPLICATIONS

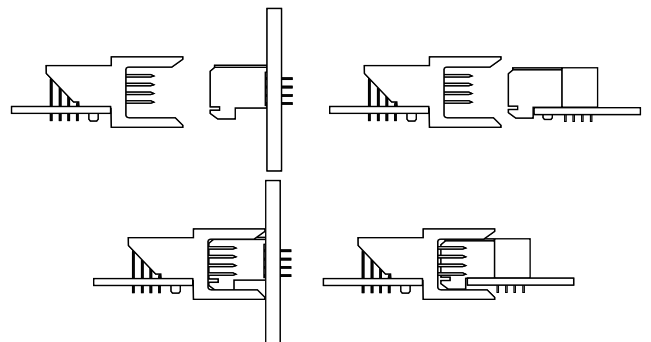

# Header, 4 row, signal, right angle, press fit, narrow body

## PRODUCT

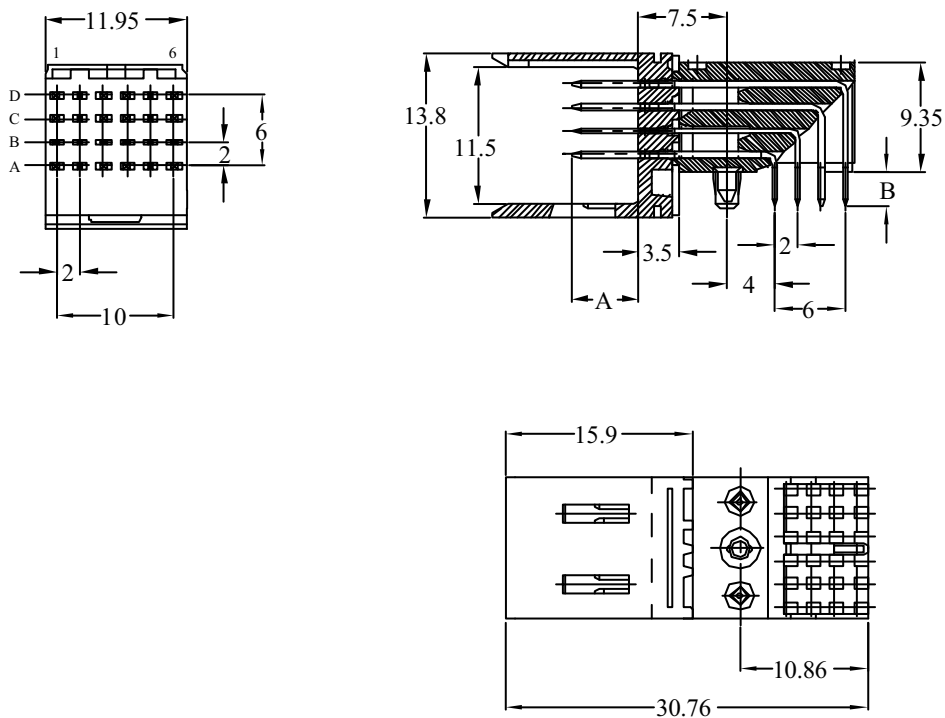

PCB pattern P1, see chapter PCB layouts

## PARTNUMBERS

58363 - 1yyLF

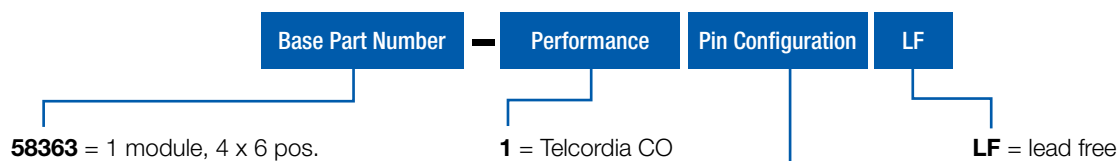

yy	mating length (A)	tail length (B)
01	5,00 mm	2,90 mm
05	5,75 mm	2,90 mm

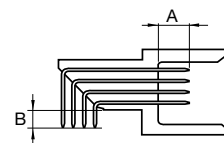

**Note:** for other special patterns or loadings, please check drawings, all other configurations on request only

## Header, 4 row, signal, right angle, pin-in-paste, narrow body

### FEATURES

- In accordance with IEC 60917 and IEC 61076-4-104 (Futurebus+)
- 4 row and 2 mm pitch permit high signal density ( 200 contacts per 100mm connector length)
- Modular design guarantees flexibility
- Narrow body housing

### TECHNICAL DATA

#### PHYSICAL

- spacing: 2,00 mm x 2,00 mm
- housing: glass-filled LCP, colour natural
- flammability rating: UL 94 V-0
- pin material: phosphor bronze
- performance level: Telcordia CO

#### ELECTRICAL

- current rating: 1 A
- insulation resistance: 5x10<sup>3</sup> MΩ initially, 1x10<sup>3</sup> MΩ after tests
- withstanding voltage: 1000 V rms (sea level)

#### MECHANICAL PERFORMANCE

- insertion force: 0,45 N max. per individual signal contact (mating)
- withdrawal force: 0,15 N max. per individual signal contact (unmating)
- recommended hole diameter: 0,65-0,80 mm

#### ENVIRONMENTAL

- Operating temperature range: -55°C to +125°C
- RoHs information, this product is compatible according to the European Union Directive 2002/95/IEC

#### PACKAGING

- standard: tape&reel

#### PROCESSING INFORMATION

- Pick&place by vacuum nozzle or mechanical gripper
- automatic Surface-mount reflow process, resistance for Lead Free reflow temperature

#### REFERENCE DATA

- Product specification: GS-12-446

#### APPLICATION EQUIPMENT

- for application equipment, check out the application equipment table on page 217-223



### MATING DATA

- Receptacle, straight, press-fit, page 69
  - 1 mod – part number 85757-1101LF
- Receptacle, straight, solder-to-board, page 67
  - 1 mod – part numbers HM1S41FRR000H6PLF

### TYPICAL APPLICATIONS

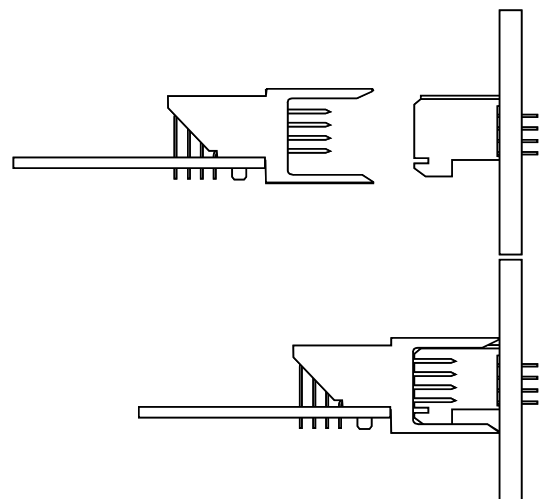

# Header, 4 row, signal, right angle, pin-in-paste, narrow body

## PRODUCT

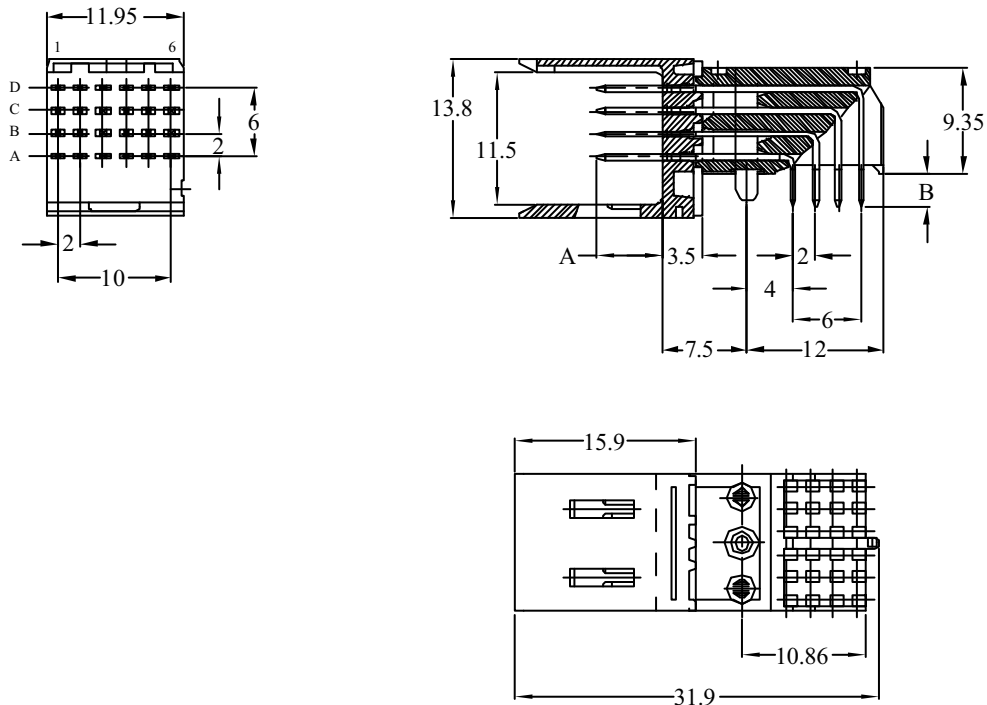

PCB pattern P1, see chapter PCB layouts

## PARTNUMBERS

**58361 - 101LF**

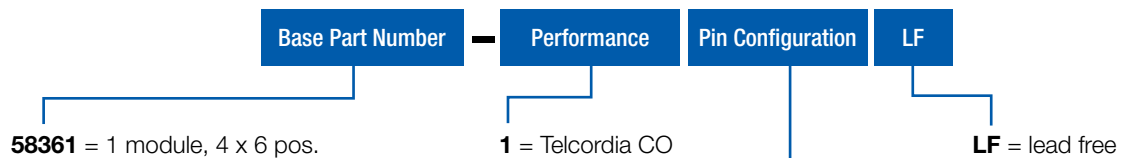

yy	mating length (A)	tail length (B)
01	5,75 mm	2,90 mm

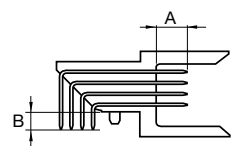

**Note:** for other special patterns or loadings, please check drawings, all other configurations on request only

## Receptacle, 4 row, signal, straight, solder to board

### FEATURES

- In accordance with IEC 60917 and IEC 61076-4-104 (Futurebus+)
- 4 row and 2 mm pitch permit high signal density (200 contacts per 100mm connector length)
- Modular design guarantees flexibility
- Parallel board applications
- Tuning fork contact

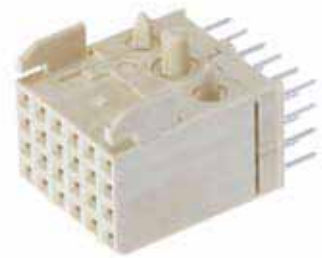

### TECHNICAL DATA

#### PHYSICAL

- spacing: 2,00 mm x 2,00 mm
- housing: glass-filled LCP, colour natural
- flammability rating: UL 94 V-0
- contact material: phosphor bronze
- performance level: Telcordia CO

#### ELECTRICAL

- current rating: 1 A
- insulation resistance: 5x10<sup>3</sup> MΩ initially, 1x10<sup>3</sup> MΩ after tests
- withstanding voltage: 1000 V rms (sea level)

#### MECHANICAL PERFORMANCE

- insertion force: 0,45 N max. per individual signal contact (mating)
- withdrawal force: 0,15 N max. per individual signal contact (unmating)
- recommended hole diameter: 0,65-0,80 mm

#### ENVIRONMENTAL

- Operating temperature range: -55°C to +125°C
- RoHs information, this product is compatible according to the European Union Directive 2002/95/IEC

#### PACKAGING

- standard: trays

#### PROCESSING INFORMATION

- Applicable process: wave, IR, vapor phase

#### REFERENCE DATA

- Product specification: GS-12-448

#### APPLICATION EQUIPMENT

- for application equipment, check out the application equipment table on page 217-223

### MATING DATA

#### Header, right angle, press-fit, page 57

- 1 module-part number HM1L41LDP000H6PLF
- 2 module-part number HM1L42LDP000H6PLF
- 4 module-part number HM1L43LDP000H6PLF
- 8 module-part number HM1L44LDP000H6PLF

#### Header, right angle, solder-to-board, page 55

- 1 module-part number HM1L41LAP000H6PLF
- 2 module-part number HM1L42LAP000H6PLF
- 4 module-part number HM1L43LAP000H6PLF
- 8 module-part number HM1L44LAP000H6PLF

#### Header, right angle, Pin-in-Paste, page 59

- 1 module-part number HM1L41LFP000H6PLF

### TYPICAL APPLICATIONS

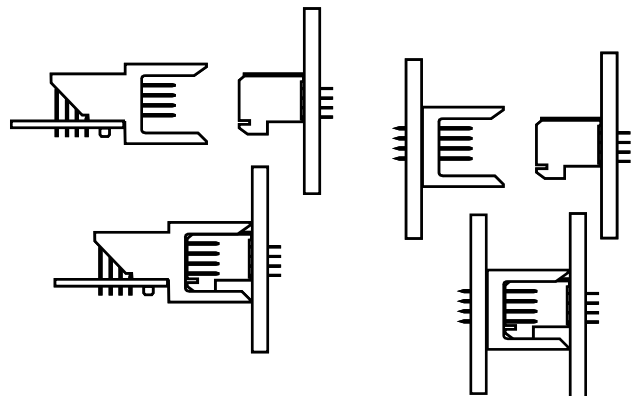



# Receptacle, 4 row, signal, straight, solder to board

## PRODUCT

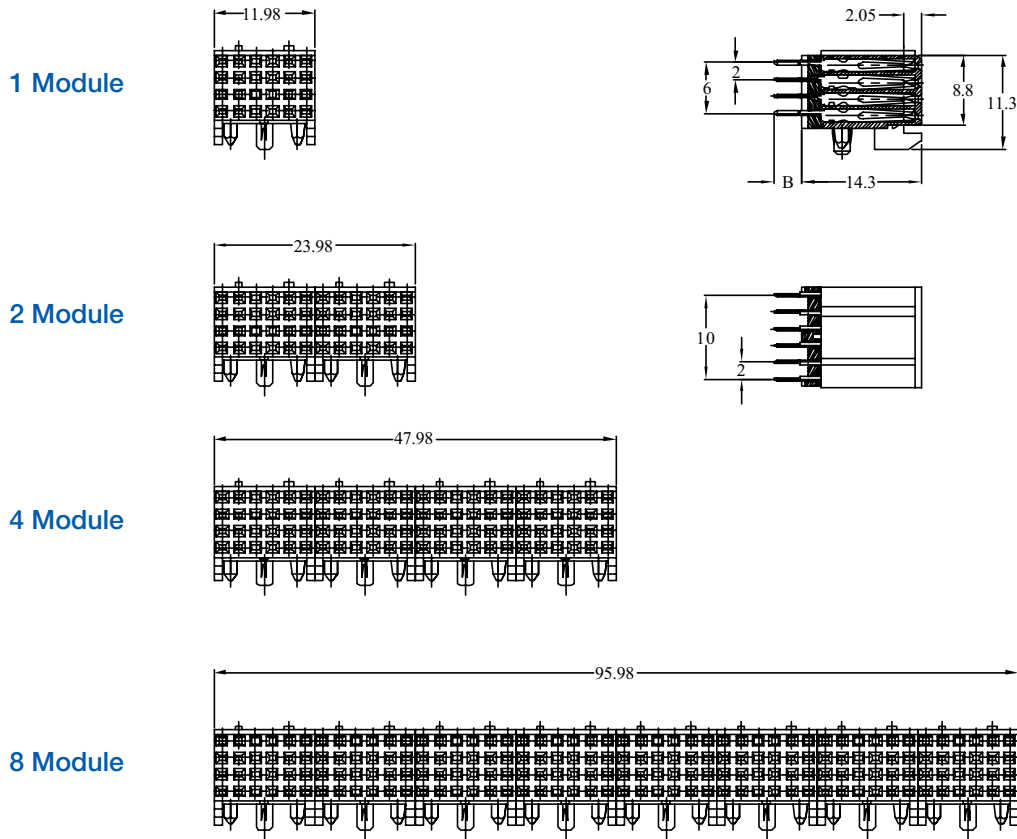

PCB pattern P5, see chapter PCB layouts

## PARTNUMBERS

HM1S4 x FRR000H6PLF

Base Part Number	Type	no. of rows	no. of pos.	Configuration	000	Performance	Packaging	LF
HM1	S = signal receptacle straight	4 = 4 row		FRR = solder to board		H6 = Telcordia CO		LF = lead free
				tail length (B) 3,30 mm			P = trays	
			1 = 1 module (4 x 6 pos.) 2 = 2 module (4 x 12 pos.) 3 = 4 module (4 x 24 pos.) 4 = 8 module (4 x 48 pos.)					

**Note:** for other special patterns or loadings, please check drawings, all other configurations on request only

## Receptacle, 4 row, signal, straight, press fit

### FEATURES

- In accordance with IEC 60917 and IEC 61076-4-104 (Futurebus+)
- 4 row and 2 mm pitch permit high signal density (200 contacts per 100mm connector length)
- Modular design guarantees flexibility
- Parallel board applications
- Tuning fork contact
- Baby H-shape press-fit contact
- Flat rock design; can be pressed on PCB with flat press block

### TECHNICAL DATA

#### PHYSICAL

- spacing: 2,00 mm x 2,00 mm
- housing: glass-filled LCP, colour natural
- flammability rating: UL 94 V-0
- contact material: phosphor bronze
- performance level: Telcordia CO

#### ELECTRICAL

- current rating: 1 A
- insulation resistance:  $5 \times 10^3 \text{ M}\Omega$  initially,  $1 \times 10^3 \text{ M}\Omega$  after tests
- withstanding voltage: 1000 V rms (sea level)

#### MECHANICAL PERFORMANCE

- insertion force: 0,45 N max. per individual signal contact (mating)
- withdrawal force: 0,15 N max. per individual signal contact (unmating)
- press-fit contact insertion: 100 N max. per pin
- press-fit pin withdrawal: 20 N min. per pin
- recommended hole diameter: 0,65-0,80 mm

#### ENVIRONMENTAL

- Operating temperature range:  $-55^\circ\text{C}$  to  $+125^\circ\text{C}$
- RoHs information, this product is compatible according to the European Union Directive 2002/95/IEC

#### PACKAGING

- standard: tubes

#### PROCESSING INFORMATION

- press fit

#### REFERENCE DATA

- Product specification: GS-12-447

#### APPLICATION EQUIPMENT

- for application equipment, check out the application equipment table on page 217-223



### MATING DATA

#### Header, right angle, press-fit, page 57

- 1 module-part number HM1L41LDP000H6PLF
- 2 module-part number HM1L42LDP000H6PLF
- 4 module-part number HM1L43LDP000H6PLF
- 8 module-part number HM1L44LDP000H6PLF

#### Header, right angle, solder-to-board, page 55

- 1 module-part number HM1L41LAP000H6PLF
- 2 module-part number HM1L42LAP000H6PLF
- 4 module-part number HM1L43LAP000H6PLF
- 8 module-part number HM1L44LAP000H6PLF

#### Header, right angle, Pin-in-Paste, page 59

- 1 module-part number HM1L41LFP000H6PLF

### TYPICAL APPLICATIONS

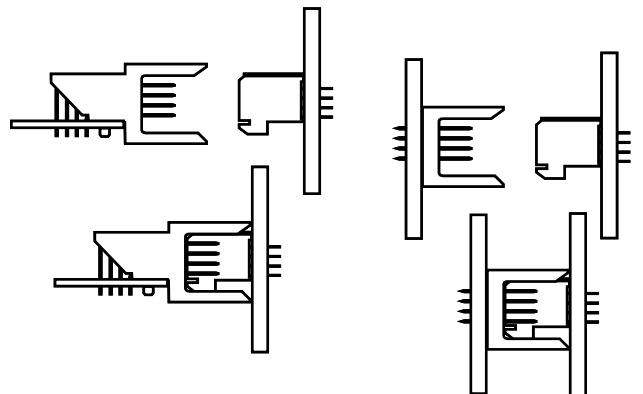

# Receptacle, 4 row, signal, straight, press fit

## PRODUCT

### 1 Module

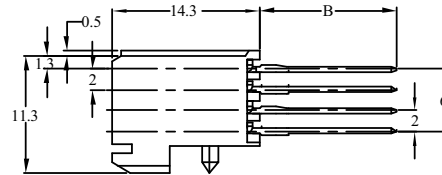
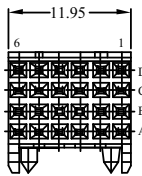

### 2 Module

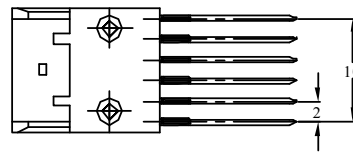
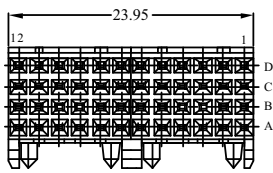

### 4 Module

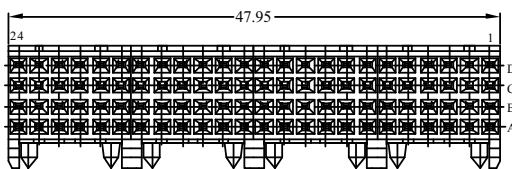

### 8 Module

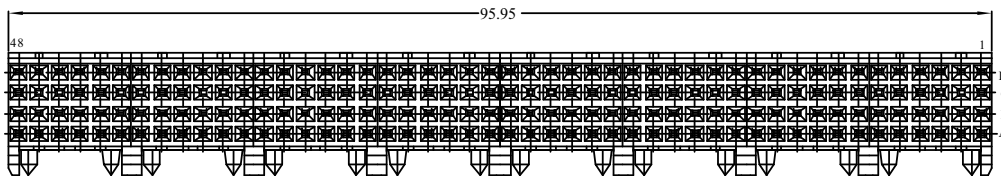

PCB pattern P6, see chapter PCB layouts

## PARTNUMBERS

8575x - 1y01LF



**85757** = 1 module (4 x 6 pos.)  
**85758** = 2 module (4 x 12 pos.)  
**85759** = 4 module (4 x 24 pos.)  
**85760** = 8 module (4 x 48 pos.)

**1** = Telcordia CO

**01** = fully loaded

**LF** = lead free

y	tail length (B)
<b>1</b>	4,3 mm
2	13,6 mm
3	17,1 mm

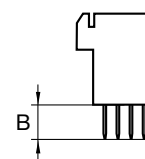

**Note:** blue marked in **tail length** is the preferred recommended standard  
for other special patterns or loadings, please check drawings, all other configurations on request only

## Header, 5 row, signal, right angle, solder to board, wide body

### FEATURES

- In accordance with IEC 60917 and IEC 61076-4-104 (Futurebus+)
- 5 row and 2 mm pitch permit high signal density ( 250 contacts per 100mm connector length)
- Modular design guarantees flexibility

### TECHNICAL DATA

#### PHYSICAL

- spacing: 2,00 mm x 2,00 mm
- housing: glass-filled LCP, colour natural
- flammability rating: UL 94 V-0
- pin material: phosphor bronze
- performance level: Telcordia CO

#### ELECTRICAL

- current rating: 1 A
- insulation resistance:  $5 \times 10^3 \text{ M}\Omega$  initially,  $1 \times 10^3 \text{ M}\Omega$  after tests
- withstanding voltage: 1000 V rms (sea level)

#### MECHANICAL PERFORMANCE

- insertion force: 0,45 N max. per individual signal contact (mating)
- withdrawal force: 0,15 N max. per individual signal contact (unmating)
- recommended hole diameter: 0,65-0,80 mm

#### ENVIRONMENTAL

- Operating temperature range: -55°C to +125°C
- RoHs information, this product is compatible according to the European Union Directive 2002/95/IEC

#### PACKAGING

- standard: trays

#### PROCESSING INFORMATION

- applicable soldering process: wave, IR, vapor phase

#### REFERENCE DATA

- Product specification: GS-12-446

#### APPLICATION EQUIPMENT

- for application equipment, check out the application equipment table on page 217-223



### MATING DATA

#### ■ Receptacle, straight, press-fit, page 79

- 1 mod – part number 85761-1101LF
- 2 mod – on request only
- 4 mod – part number 85763-1101LF
- 8 mod – on request only

#### ■ Receptacle, straight, solder-to-board, page 77

- 1 mod – part numbers HM1S51FRR000H6PLF
- 2 mod – part numbers HM1S52FRR000H6PLF
- 4 mod – part numbers HM1S53FRR000H6PLF
- 8 mod - part numbers HM1S54FRR000H6PLF

### TYPICAL APPLICATIONS

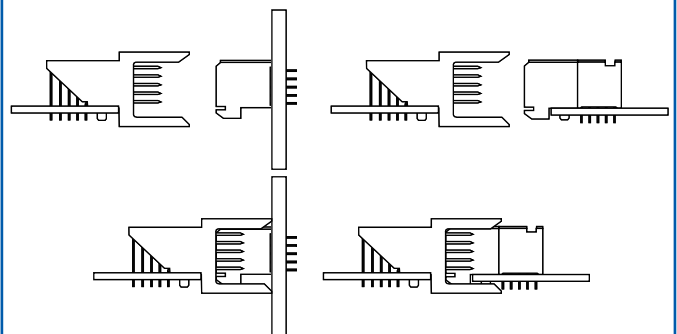

# Header, 5 row, signal, right angle, solder to board, wide body

## PRODUCT

### 1 Module

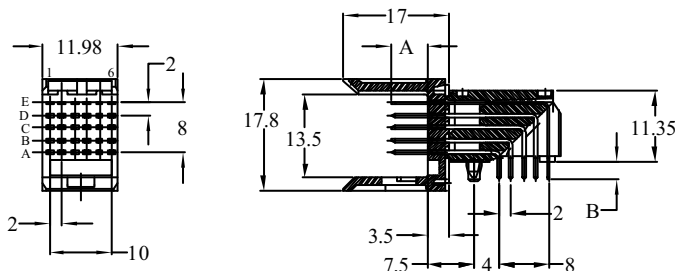

### 2 Module

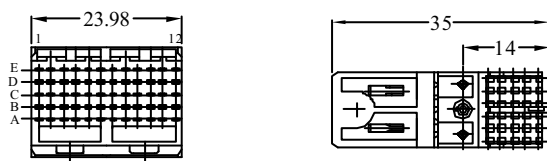

### 4 Module

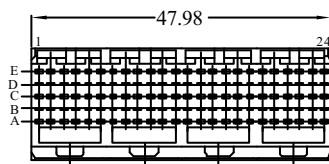

### 8 Module

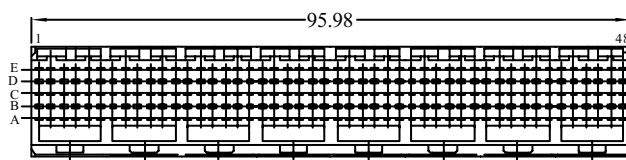

PCB pattern P2, see chapter PCB layouts

## PARTNUMBERS

HM1L5 x LAP000H6PLF

Base Part Number	Type	no. of rows	no. of pos.	Configuration	000	Performance	Packaging	LF						
HM1	L = Signal header right angle, wide body	5 = 5 row	LAP = solder to board <table border="1"> <thead> <tr> <th>mating length (A)</th> <th>tail length (B)</th> </tr> </thead> <tbody> <tr> <td>5,75 mm</td> <td>2,90 mm</td> </tr> <tr> <td colspan="2">1,6 mm PCB thickness</td> </tr> </tbody> </table>	mating length (A)	tail length (B)	5,75 mm	2,90 mm	1,6 mm PCB thickness				H6 = Telcordia CO	P = trays	LF = lead free
mating length (A)	tail length (B)													
5,75 mm	2,90 mm													
1,6 mm PCB thickness														
		1 = 1 module (5 x 6 pos.) 2 = 2 module (5 x 12 pos.) 3 = 4 module (5 x 24 pos.) 4 = 8 module (5 x 48 pos.)												

**Note:** for other special patterns or loadings, please check drawings, all other configurations on request only

## Header, 5 row, signal, right angle, press fit, wide body

### FEATURES

- In accordance with IEC 60917 and IEC 61076-4-104 (Futurebus+)
- 5 row and 2 mm pitch permit high signal density ( 250 contacts per 100mm connector length)
- Modular design guarantees flexibility
- Eye of the needle press-fit contact

### TECHNICAL DATA

#### PHYSICAL

- spacing: 2,00 mm x 2,00 mm
- housing: glass-filled LCP, colour natural
- flammability rating: UL 94 V-0
- pin material: phosphor bronze
- performance level: Telcordia CO

#### ELECTRICAL

- current rating: 1 A
- insulation resistance:  $5 \times 10^3 \text{ M}\Omega$  initially,  $1 \times 10^3 \text{ M}\Omega$  after tests
- withstanding voltage: 1000 V rms (sea level)

#### MECHANICAL PERFORMANCE

- insertion force: 0,45 N max. per individual signal contact (mating)
- withdrawal force: 0,15 N max. per individual signal contact (unmating)
- press-fit contact insertion: 55 N max. per pin
- press-fit pin withdrawal: 15 N min. per pin
- recommended hole diameter: 0,65-0,80 mm

#### ENVIRONMENTAL

- Operating temperature range:  $-55^\circ\text{C}$  to  $+125^\circ\text{C}$
- RoHs information, this product is compatible according to the European Union Directive 2002/95/IEC

#### PACKAGING

- standard: trays

#### PROCESSING INFORMATION

- press fit

#### REFERENCE DATA

- Product specification: GS-12-445

#### APPLICATION EQUIPMENT

- for application equipment, check out the application equipment table on page 217-223



### MATING DATA

#### ■ Receptacle, straight, press-fit, page 79

- 1 mod – part number 85761-1101LF
- 2 mod – on request only
- 4 mod – part number 85763-1101LF
- 8 mod – on request only

#### ■ Receptacle, straight, solder-to-board, page 77

- 1 mod – part numbers HM1S51FRR000H6PLF
- 2 mod – part numbers HM1S52FRR000H6PLF
- 4 mod – part numbers HM1S53FRR000H6PLF
- 8 mod - part numbers HM1S54FRR000H6PLF

### TYPICAL APPLICATIONS

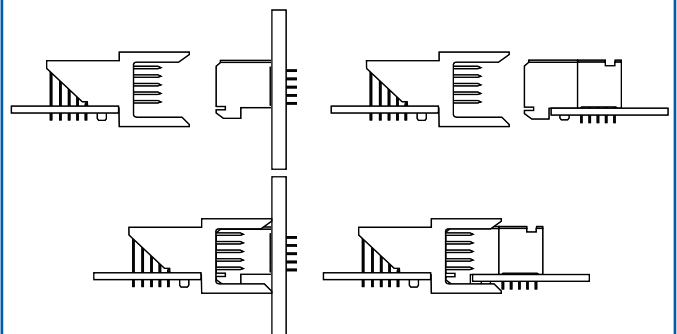



## Header, 5 row, signal, right angle, pin-in-paste, wide body

### FEATURES

- In accordance with IEC 60917 and IEC 61076-4-104 (Futurebus+)
- 5 row and 2 mm pitch permit high signal density ( 250 contacts per 100mm connector length)
- Modular design guarantees flexibility

### TECHNICAL DATA

#### PHYSICAL

- spacing: 2,00 mm x 2,00 mm
- housing: glass-filled LCP, colour natural
- flammability rating: UL 94 V-0
- pin material: phosphor bronze
- performance level: Telcordia CO

#### ELECTRICAL

- current rating: 1 A
- insulation resistance: 5x10<sup>3</sup> MΩ initially, 1x10<sup>3</sup> MΩ after tests
- withstanding voltage: 1000 V rms (sea level)

#### MECHANICAL PERFORMANCE

- insertion force: 0,45 N max. per individual signal contact (mating)
- withdrawal force: 0,15 N max. per individual signal contact (unmating)
- recommended hole diameter: 0,65-0,80 mm

#### ENVIRONMENTAL

- Operating temperature range: -55°C to +125°C
- RoHs information, this product is compatible according to the European Union Directive 2002/95/IEC

#### PACKAGING

- standard: trays

#### PROCESSING INFORMATION

- Pick&place by vacuum nozzle or mechanical gripper
- automatic Surface-mount reflow process, resistance for Lead Free reflow temperature

#### REFERENCE DATA

- Product specification: GS-12-446

#### APPLICATION EQUIPMENT

- for application equipment, check out the application equipment table on page 217-223



### MATING DATA

- Receptacle, straight, press-fit, page 79
  - 1 mod – part number 85761-1101LF
- Receptacle, straight, solder-to-board, page 77
  - 1 mod – part numbers HM1S51FRR000H6PLF

### TYPICAL APPLICATIONS

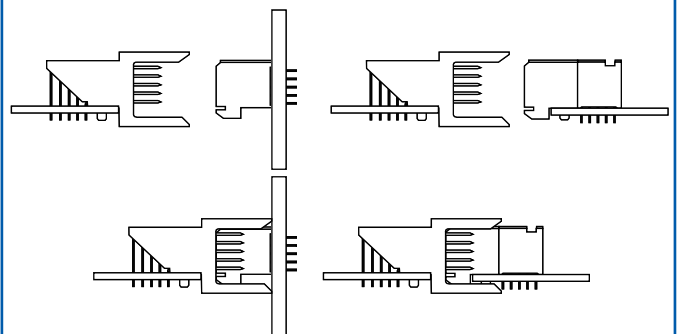



# Header, 5 row, signal, right angle, pin-in-paste, wide body

## PRODUCT

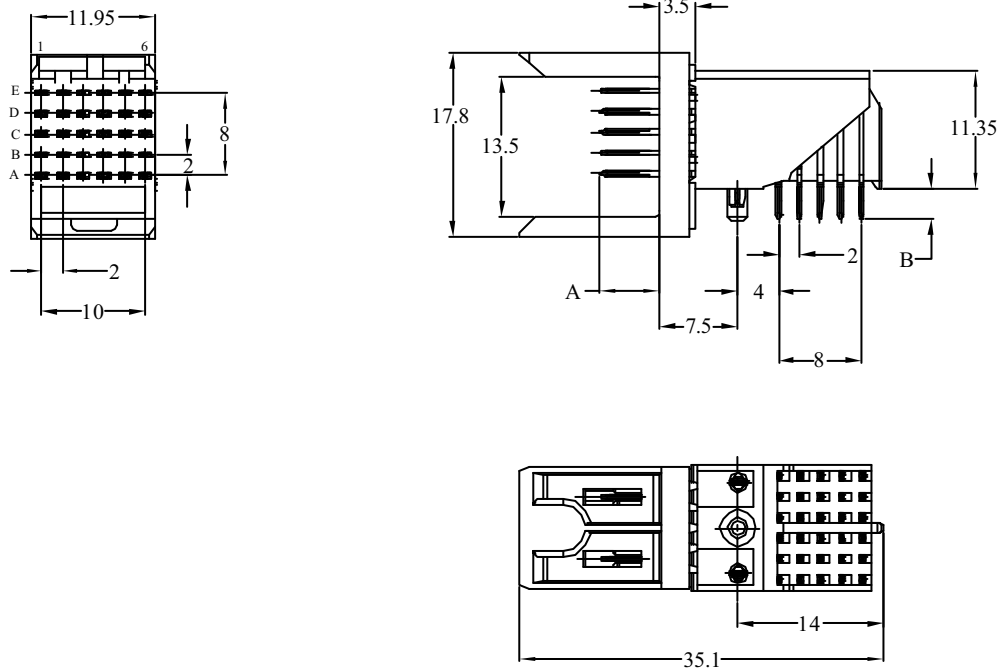

PCB pattern P2, see chapter PCB layouts

## PARTNUMBERS

HM1L5 x LFP000H6PLF

Base Part Number	Type	no. of rows	no. of pos.	Configuration	000	Performance	Packaging	LF						
HM1	L = Signal header right angle, wide body	5 = 5 row	1 = 1 module (5 x 6 pos.)	LFP = Pin-in-Paste	000	H6 = Telcordia CO	P = trays	LF = lead free						
				<table border="1"> <thead> <tr> <th>mating length (A)</th> <th>tail length (B)</th> </tr> </thead> <tbody> <tr> <td>5,75 mm</td> <td>2,90 mm</td> </tr> <tr> <td colspan="2">1,6 mm PCB thickness</td> </tr> </tbody> </table>	mating length (A)	tail length (B)	5,75 mm	2,90 mm	1,6 mm PCB thickness					
mating length (A)	tail length (B)													
5,75 mm	2,90 mm													
1,6 mm PCB thickness														

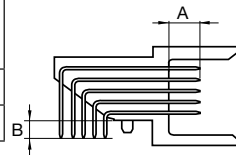

**Note:** for other special patterns or loadings, please check drawings, all other configurations on request only

## Receptacle, 5 row, signal, straight, solder to board

### FEATURES

- In accordance with IEC 60917 and IEC 61076-4-104 (Futurebus+)
- 5 row and 2 mm pitch permit high signal density (250 contacts per 100mm connector length)
- Modular design guarantees flexibility
- Parallel board applications
- Tuning fork contact



### TECHNICAL DATA

#### PHYSICAL

- spacing: 2,00 mm x 2,00 mm
- housing: glass-filled LCP, colour natural
- flammability rating: UL 94 V-0
- contact material: phosphor bronze
- performance level: Telcordia CO

#### ELECTRICAL

- current rating: 1 A
- insulation resistance:  $5 \times 10^3 \text{ M}\Omega$  initially,  $1 \times 10^3 \text{ M}\Omega$  after tests
- withstanding voltage: 1000 V rms (sea level)

#### MECHANICAL PERFORMANCE

- insertion force: 0,45 N max. per individual signal contact (mating)
- withdrawal force: 0,15 N max. per individual signal contact (unmating)
- recommended hole diameter: 0,65-0,80 mm

#### ENVIRONMENTAL

- Operating temperature range:  $-55^\circ\text{C}$  to  $+125^\circ\text{C}$
- RoHs information, this product is compatible according to the European Union Directive 2002/95/IEC

#### PACKAGING

- standard: trays

#### PROCESSING INFORMATION

- Applicable process: wave, IR, vapor phase

#### REFERENCE DATA

- Product specification: GS-12-448

#### APPLICATION EQUIPMENT

- for application equipment, check out the application equipment table on page 217-223

### MATING DATA

#### Header, right angle, press-fit, page 73

- 1 module-part number HM1L51LDP000H6PLF
- 2 module-part number HM1L52LDP000H6PLF
- 4 module-part number HM1L53LDP000H6PLF
- 8 module-part number HM1L54LDP000H6PLF

#### Header, right angle, solder-to-board, page 71

- 1 module-part number HM1L51LAP000H6PLF
- 2 module-part number HM1L52LAP000H6PLF
- 4 module-part number HM1L53LAP000H6PLF
- 8 module-part number HM1L54LAP000H6PLF

#### Header, right angle, Pin-in-Paste, page 75

- 1 module-part number HM1L51LFP000H6PLF

### TYPICAL APPLICATIONS

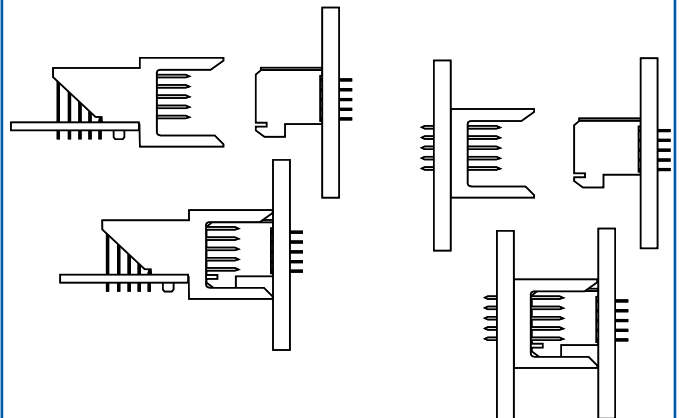

# Receptacle, 5 row, signal, straight, solder to board

## PRODUCT

1 Module

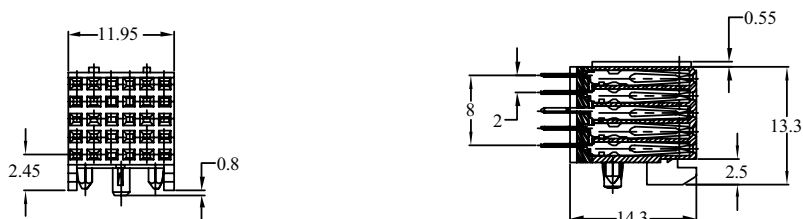

2 Module

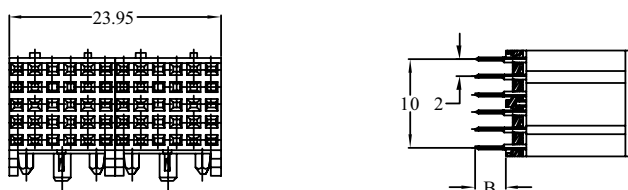

4 Module

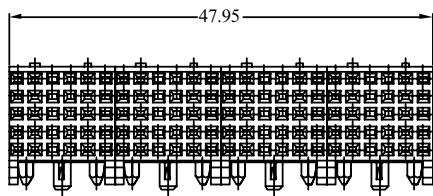

8 Module

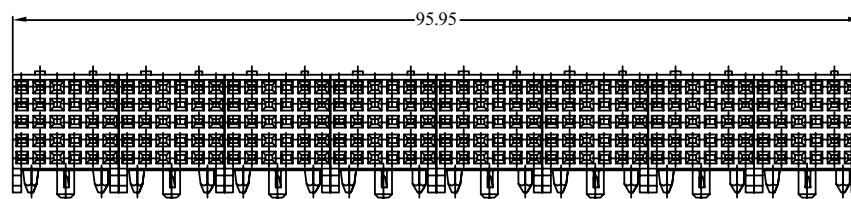

PCB pattern P7, see chapter PCB layouts

## PARTNUMBERS

HM1S5 x FRR000H6PLF

Base Part Number	Type	no. of rows	no. of pos.	Configuration	000	Performance	Packaging	LF
HM1	S = signal receptacle straight	5 = 5 row		FRR = solder to board		H6 = Telcordia CO		LF = lead free
				tail length (B)				P = trays
				3,30 mm				

1 = 1 module (5 x 6 pos.)  
 2 = 2 module (5 x 12 pos.)  
 3 = 4 module (5 x 24 pos.)  
 4 = 8 module (5 x 48 pos.)

**Note:** for other special patterns or loadings, please check drawings, all other configurations on request only

## Receptacle, 5 row, signal, straight, press fit

### FEATURES

- In accordance with IEC 60917 and IEC 61076-4-104 (Futurebus+)
- 5 row and 2 mm pitch permit high signal density (250 contacts per 100mm connector length)
- Modular design guarantees flexibility
- Parallel board applications
- Tuning fork contact
- baby H-shape press-fit contact
- Flat rock design; can be pressed on PCB with flat press block

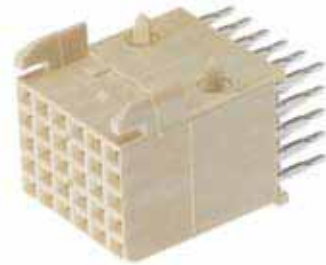

### TECHNICAL DATA

#### PHYSICAL

- spacing: 2,00 mm x 2,00 mm
- housing: glass-filled LCP, colour natural
- flammability rating: UL 94 V-0
- contact material: phosphor bronze
- performance level: Telcordia CO

#### ELECTRICAL

- current rating: 1 A
- insulation resistance:  $5 \times 10^3 \text{ M}\Omega$  initially,  $1 \times 10^3 \text{ M}\Omega$  after tests
- withstanding voltage: 1000 V rms (sea level)

#### MECHANICAL PERFORMANCE

- insertion force: 0,45 N max. per individual signal contact (mating)
- withdrawal force: 0,15 N max. per individual signal contact (unmating)
- press-fit contact insertion: 100 N max. per pin
- press-fit pin withdrawal: 20 N min. per pin
- recommended hole diameter: 0,65-0,80 mm

#### ENVIRONMENTAL

- Operating temperature range: -55°C to +125°C
- RoHs information, this product is compatible according to the European Union Directive 2002/95/IEC

#### PACKAGING

- standard: tubes

#### PROCESSING INFORMATION

- press fit

#### REFERENCE DATA

- Product specification: GS-12-447

#### APPLICATION EQUIPMENT

- for application equipment, check out the application equipment table on page 217-223

### MATING DATA

#### Header, right angle, press-fit, page 73

- 1 module-part number HM1L51LDP000H6PLF
- 2 module-part number HM1L52LDP000H6PLF
- 4 module-part number HM1L53LDP000H6PLF
- 8 module-part number HM1L54LDP000H6PLF

#### Header, right angle, solder-to-board, page 71

- 1 module-part number HM1L51LAP000H6PLF
- 2 module-part number HM1L52LAP000H6PLF
- 4 module-part number HM1L53LAP000H6PLF
- 8 module-part number HM1L54LAP000H6PLF

#### Header, right angle, Pin-in-Paste, page 75

- 1 module-part number HM1L51LFP000H6PLF

### TYPICAL APPLICATIONS

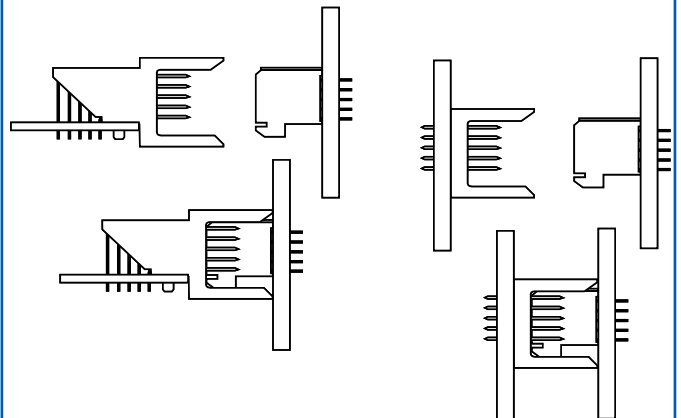

# Receptacle, 5 row, signal, straight, press fit

## PRODUCT

### 1 Module

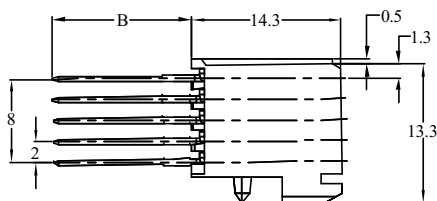
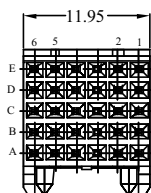

### 2 Module

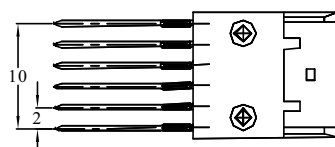
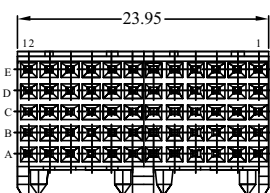

### 4 Module

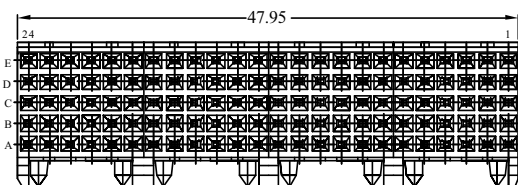

### 8 Module

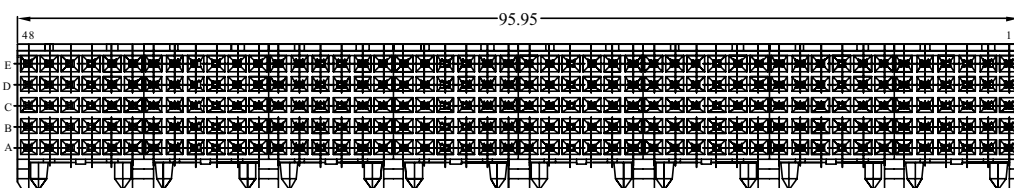

PCB pattern P7, see chapter PCB layouts

## PARTNUMBERS

8576x - 1y01LF

Base Part Number

Performance

Tail length

Pin Configuration

LF

**85761**

= 1 module (5 x 6 pos.)

*on request only*

= 2 module (5 x 12 pos.)

**85763**

= 4 module (5 x 24 pos.)

*on request only*

= 8 module (5 x 48 pos.)

**1** = Telcordia CO

**01** = fully loaded

**LF** = lead free

y	tail length (B)
<b>1</b>	4,3 mm
2	13,6 mm
3	17,1 mm

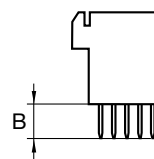



**Note:** blue marked in **tail length** is the preferred recommended standard

for other special patterns or loadings, please check drawings, all other configurations on request only





## METRAL® SHROUDS

-  Shroud, 4 row, wide body
-  Shroud, 5 row, wide body
-  Shroud, 8 row, wide body

# Shroud, 4 row, wide body

## FEATURES

- In accordance with IEC 60917 and IEC 61076-4-104 (Futurebus+)
- Different stand-off versions for rear-plug-up
- Easy direct mounting of the shroud on the pins without need of mounting shroud to PCB.
- Retention force from the shroud on the press-connector is on the non-contact side of the pin.
- Wide lead-in for easy mating of female connectors
- Designed-in polarization.
- Optional coding.



## TECHNICAL DATA

### PHYSICAL

- housing: glass-filled LCP, colour natural
- flammability rating: UL 94 V-0

### ELECTRICAL

- withstanding voltage: 1000 V rms (sea level)

### MECHANICAL PERFORMANCE

- insertion force: 0,45 N max. per individual signal contact (mating)
- withdrawal force: 0,15 N max. per individual signal contact (unmating)

### ENVIRONMENTAL

- Operating temperature range: -55°C to +105°C
- RoHs information, this product is compatible according to the European Union Directive 2002/95/IEC

### PROCESSING INFORMATION

- used over pins previously staked into the pc board

### REFERENCE DATA

- product specification: GS-12-180

### APPLICATION EQUIPMENT

- for application equipment, check out the application equipment table on page 217-223.

## MATING DATA

- 4 row Header, straight, press-fit, page 27

- 1 mod 70232-116LF
- 2 mod 70233-116LF
- 4 mod 70234-116LF
- 8 mod 70235-116LF

## TYPICAL APPLICATIONS

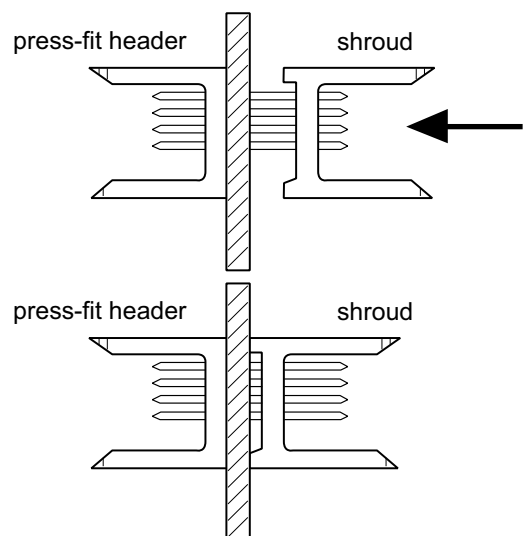



# Shroud, 4 row, wide body

## PRODUCT

**1 Module**  
70203-111LF

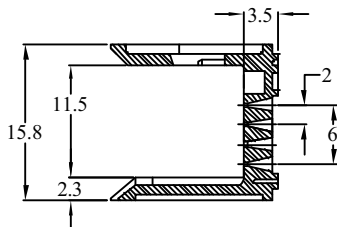
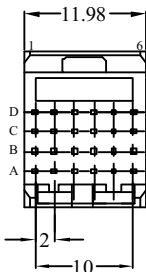

**2 Module**  
70203-112LF

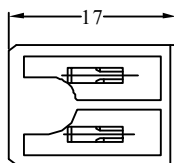
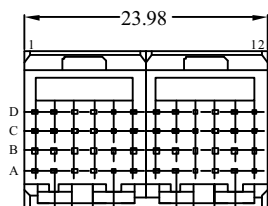

**4 Module**  
70203-113LF

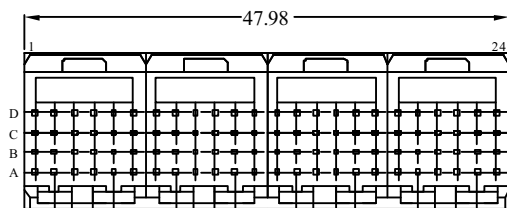

**8 Module**  
70203-114LF

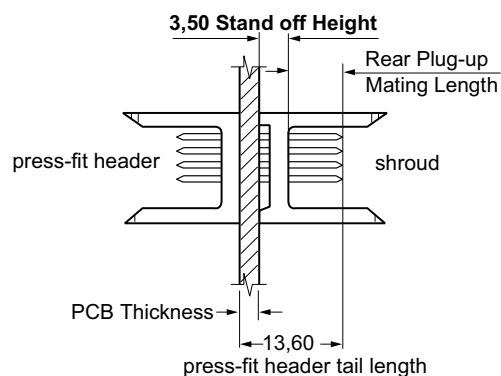
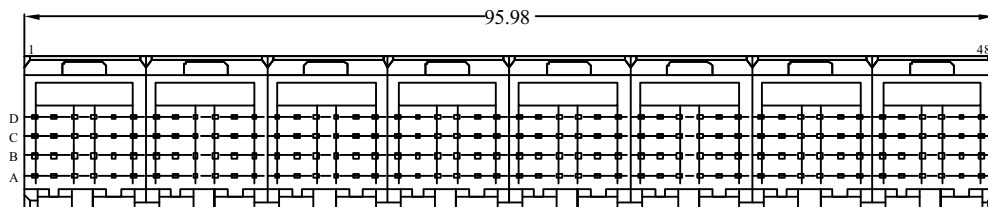

## PARTNUMBERS

70203 - yyyLF

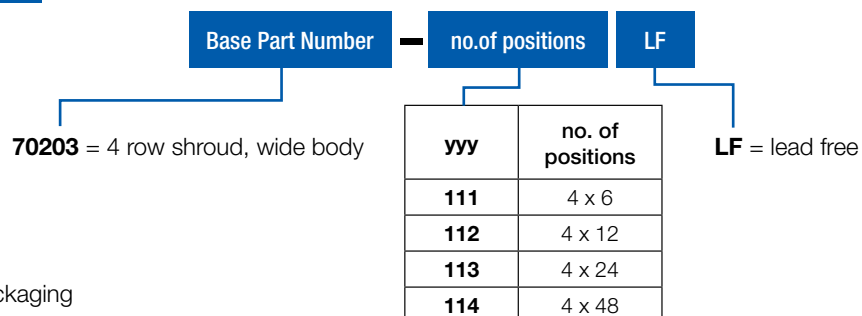

Note: Box packaging

# Shroud, 5 row, wide body

## FEATURES

- In accordance with IEC 60917 and IEC 61076-4-104 (Futurebus+)
- Different stand-off versions for rear-plug-up
- Easy direct mounting of the shroud on the pins without need of mounting shroud to PCB.
- Retention force from the shroud on the press-connector is on the non-contact side of the pin.
- Wide lead-in for easy mating of female connectors
- Designed-in polarization.
- Optional coding.



## TECHNICAL DATA

### PHYSICAL

- housing: glass-filled LCP, colour natural
- flammability rating: UL 94 V-0

### ELECTRICAL

- withstanding voltage: 1000 V rms (sea level)

### MECHANICAL PERFORMANCE

- insertion force: 0,45 N max. per individual signal contact (mating)
- withdrawal force: 0,15 N max. per individual signal contact (unmating)

### ENVIRONMENTAL

- Operating temperature range: -55°C to +105°C
- RoHs information, this product is compatible according to the European Union Directive 2002/95/IEC

### PROCESSING INFORMATION

- used over pins previously staked into the pc board

### REFERENCE DATA

- product specification: GS-12-180

### APPLICATION EQUIPMENT

- for application equipment, check out the application equipment table on page 217-223

## MATING DATA

- 4 row Header, straight, press-fit, page 41

- 1 mod 89006-116LF
- 2 mod 89007-116LF
- 4 mod 89008-116LF
- 8 mod 89009-116LF

## TYPICAL APPLICATIONS

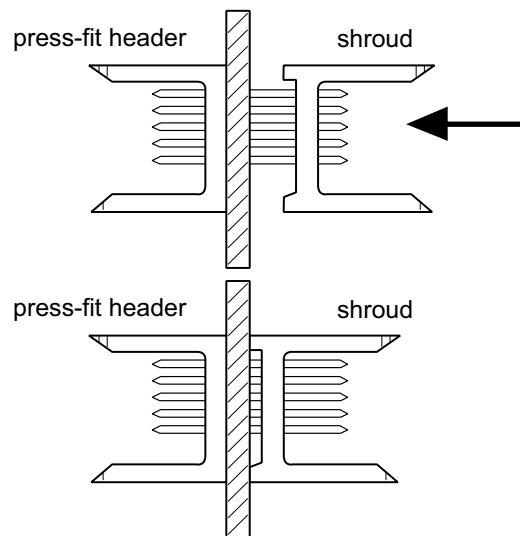

# Shroud, 5 row, wide body

## PRODUCT

**1 Module**  
89055-111LF

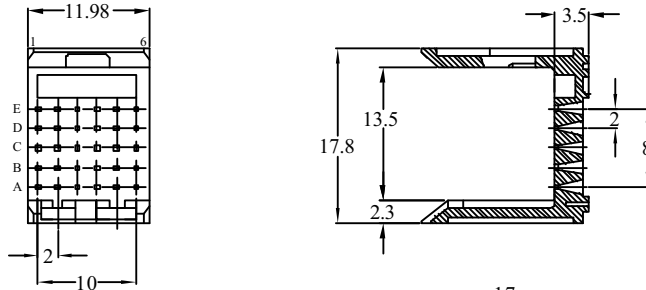

**2 Module**  
89055-112LF

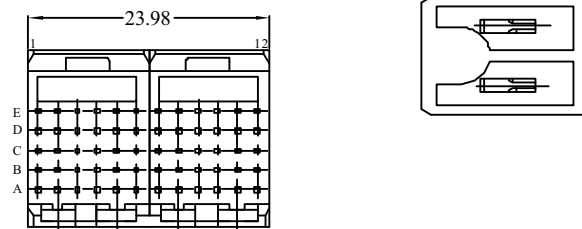

**4 Module**  
89055-113LF

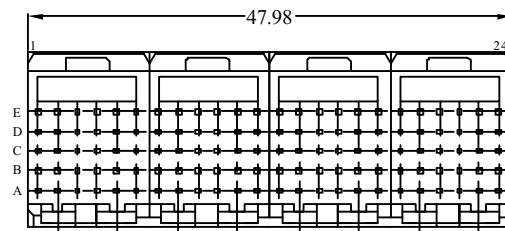

**8 Module**  
89055-114LF

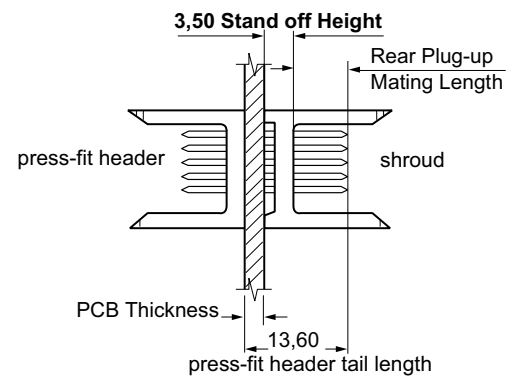
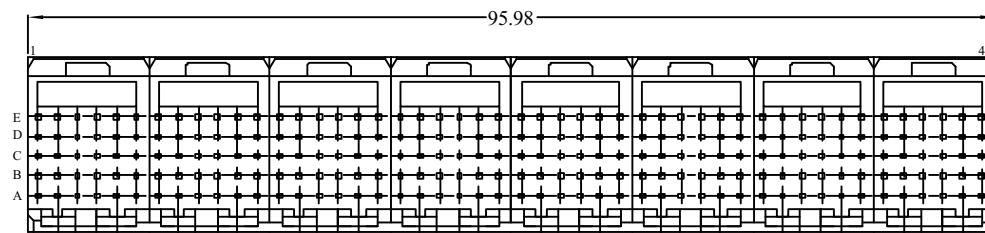

## PARTNUMBERS

89055 - yyLF

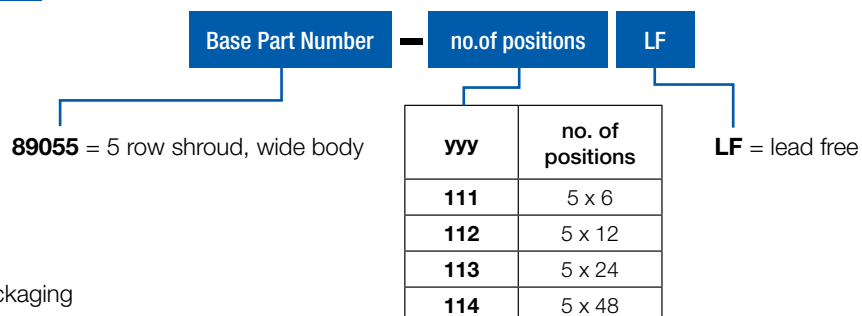

Note: Box packaging

# Shroud, 8 row, wide body

## FEATURES

- In accordance with IEC 60917 and IEC 61076-4-104 (Futurebus+)
- 8 row and 2 mm pitch permit high signal density ( 800 contacts per 100mm connector length)
- Stackable with other METRAL® function modules (power, I/O)
- 2 modules shroud, 8 rows by 6 position

## TECHNICAL DATA

### PHYSICAL

- spacing: 2,00 mm x 2,00 mm
- housing: glass-filled LCP, colour natural
- flammability rating: UL 94 V-0
- pin material: phosphor bronze
- performance level: Telcordia CO

### ELECTRICAL

- current rating: 1 A
- insulation resistance:  $5 \times 10^3 \text{ M}\Omega$  initially,  $1 \times 10^3 \text{ M}\Omega$  after tests
- withstanding voltage: 1000 V rms (sea level)

### MECHANICAL PERFORMANCE

- insertion force: 0,45 N max. per individual signal contact (mating)
- withdrawal force: 0,15 N max. per individual signal contact (unmating)

### ENVIRONMENTAL

- Operating temperature range:  $-55^\circ\text{C}$  to  $+125^\circ\text{C}$
- RoHs information, this product is compatible according to the European Union Directive 2002/95/IEC

### PACKAGING

- standard: tubes

### PROCESSING INFORMATION

- used over pins previously staked into the pc board

### REFERENCE DATA

- Product specification: GS-12-134

### APPLICATION EQUIPMENT

- for application equipment, check out the application equipment table on page 217-223



## MATING DATA

- Header, straight, press-fit, page 49

- part number 74771-102011LF (used opposite board side)

- Receptacle, straight, press-fit, page 51

- part number 74770-102LF

## TYPICAL APPLICATIONS

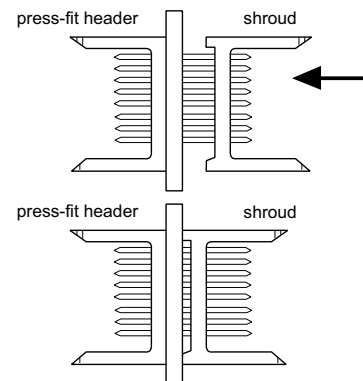

# Shroud, 8 row, wide body

## PRODUCT

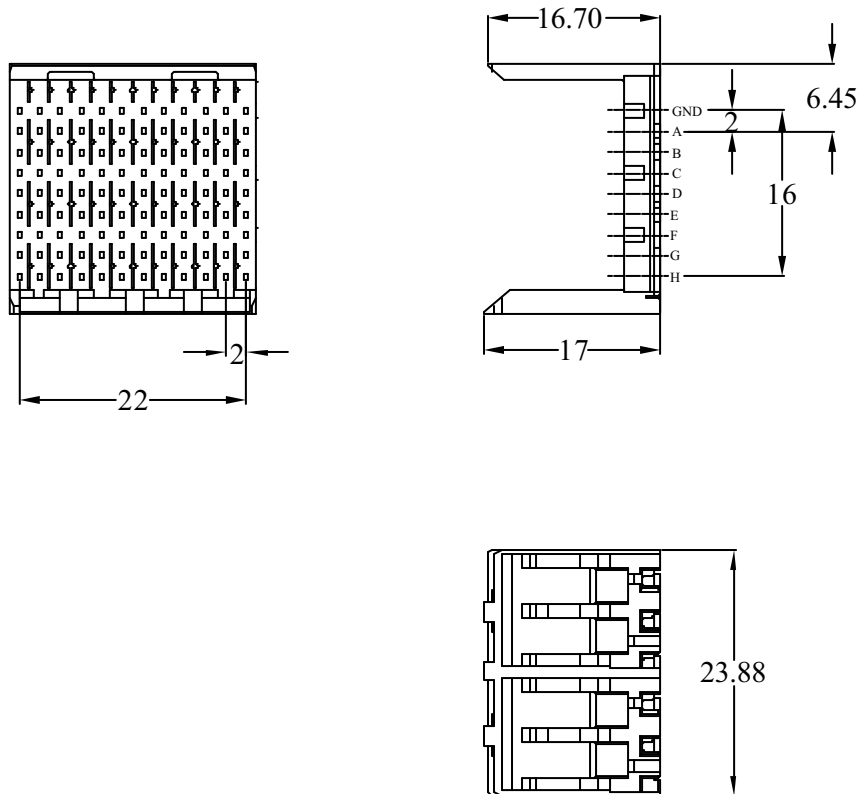

## PARTNUMBERS

**98173 - 102LF**

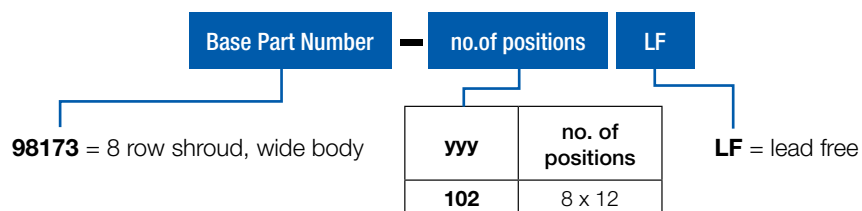



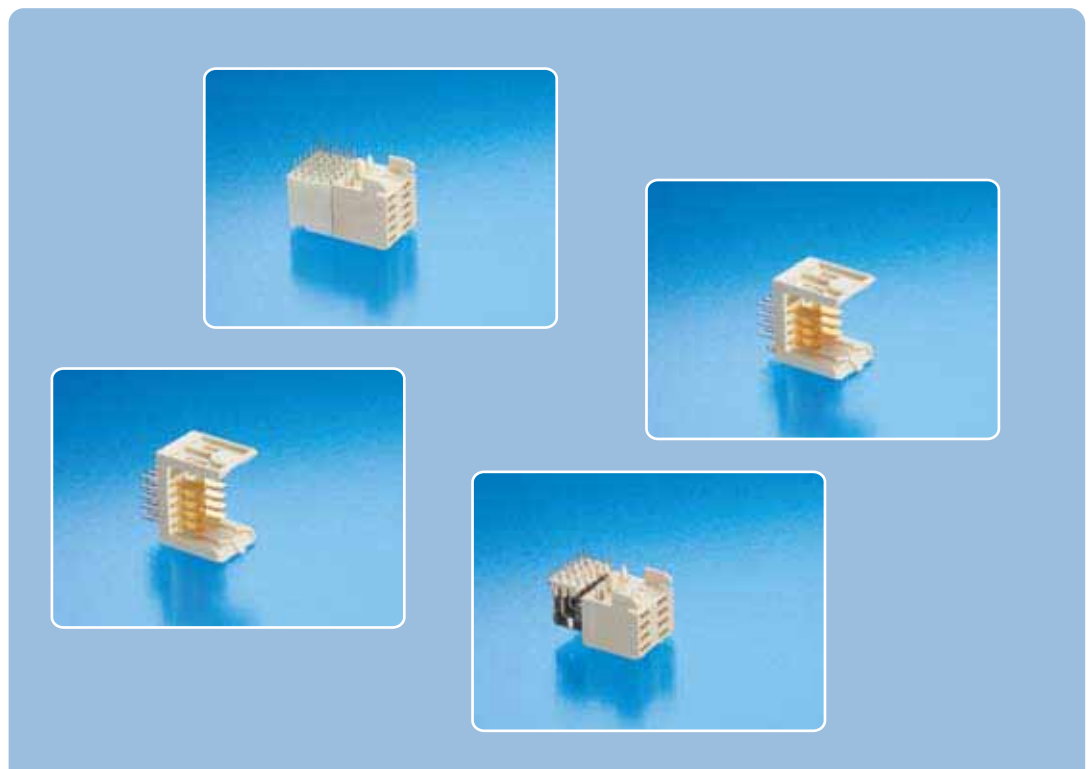

**Note:** Box packaging





## METRAL® POWER CONNECTORS STANDARD

-  Header, 4 row, straight, wide body
-  Header, 4 row, straight, narrow body
-  Receptacle, 4 row, right angle
-  Header, 5 row, straight, wide body
-  Receptacle, 5 row, right angle

## Header, 4 row power, straight, solder to board, wide body

### FEATURES

- In accordance with IEC 60917 and IEC 61076-4-104 (Futurebus+)
- 4 x 2 power blades contacts
- 12 mm power modules are form- and fit interchangeable with signal modules on same footprint

### TECHNICAL DATA

#### PHYSICAL

- spacing: 2,00 mm x 2,00 mm
- housing: glass-filled LCP (30% glass), colour natural
- flammability rating: UL 94 V-0
- contact material: phosphor bronze
- performance level: Telcordia CO

#### ELECTRICAL

- current rating: 3 A
- insulation resistance:  $5 \times 10^3 \text{ M}\Omega$  initially,  $1 \times 10^3 \text{ M}\Omega$  after tests
- withstanding voltage: 1000 V rms (sea level)

#### MECHANICAL PERFORMANCE

- insertion force: 1,50 N max. per individual power contact (mating)
- withdrawal force: 0,30 N max. per individual power contact (unmating)
- recommended hole diameter: 0,65-0,80 mm

#### ENVIRONMENTAL

- Operating temperature  $-55^\circ\text{C}$  to  $+125^\circ\text{C}$
- RoHs information, this product is compatible according to the European Union Directive 2002/95/IEC

#### PACKAGING

- Standard Tubes

#### PROCESSING INFORMATION

- Applicable process: wave, IR, vapor phase

#### REFERENCE DATA

- Product Specification GS-12-180
- Application Specification BUS-20-075

#### APPLICATION EQUIPMENT

- for application equipment, check out the application equipment table on page 217-223

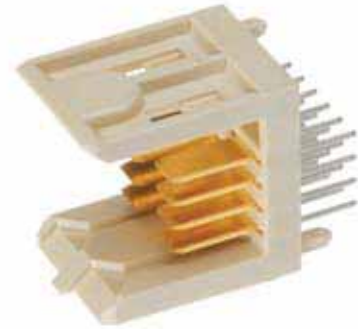

### MATING DATA

- Receptacle, right angle, press-fit, page 101
  - part number 88949-102LF
- Receptacle, right angle, solder-to-board, page 99
  - part number 89039-101LF
- Receptacle, right angle, Pin-in-Paste, page 103
  - part number 72651-101LF

### TYPICAL APPLICATIONS

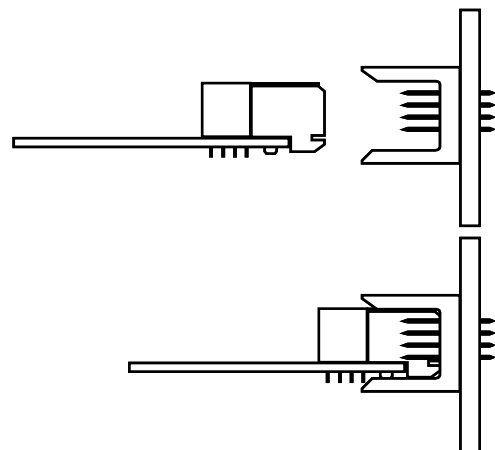



# Header, 4 row power, straight, solder to board, wide body

## PRODUCT

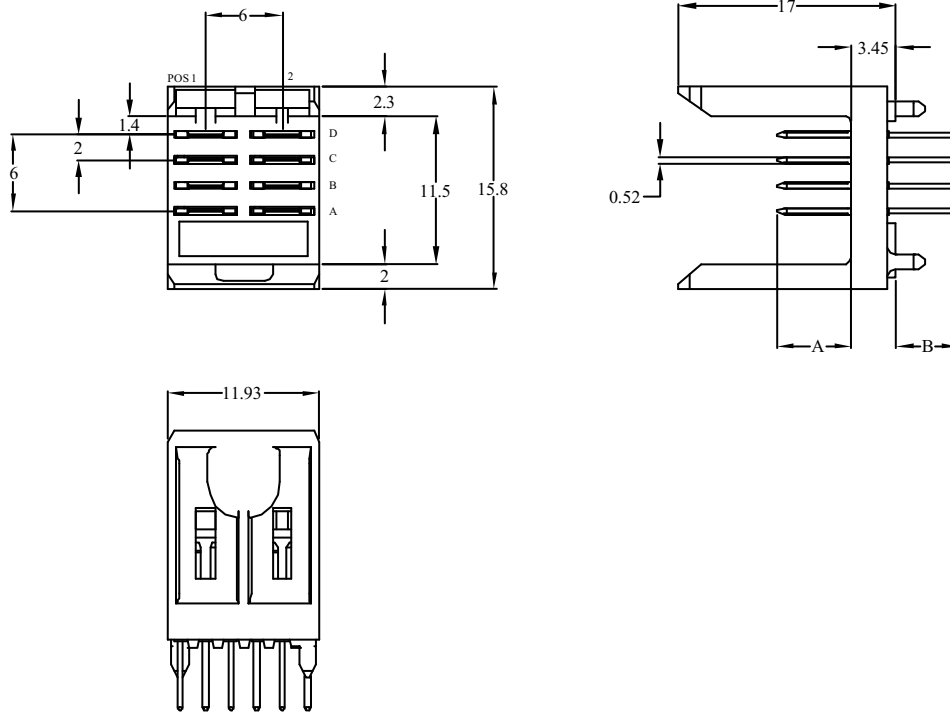

PCB pattern P5, see chapter PCB layouts

## PARTNUMBERS

**88960 - 101LF**

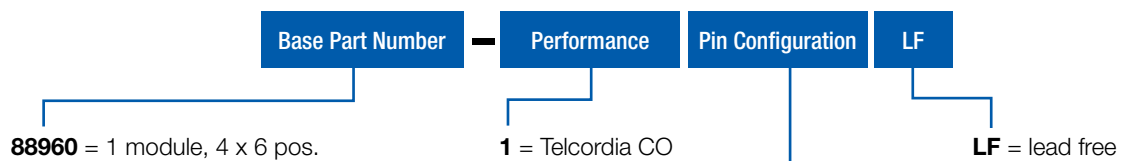

yy	mating length (A)	tail length (B)
01	6,50 mm	4,25 mm

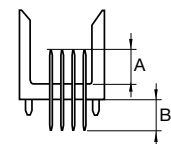

**Note:** for other special patterns or loadings, please check drawings, all other configurations on request only

## Header, 4 row power, straight, press-fit, wide body

### FEATURES

- In accordance with IEC 60917 and IEC 61076-4-104 (Futurebus+)
- 4 x 2 power blades contacts
- 12 mm power modules are form- and fit interchangeable with signal modules on same footprint
- Eye the needle press-fit contac

### TECHNICAL DATA

#### PHYSICAL

- spacing: 2,00 mm x 2,00 mm
- housing: glass-filled LCP (30% glass), colour natural
- flammability rating: UL 94 V-0
- contact material: phosphor bronze
- performance level: Telcordia CO

#### ELECTRICAL

- current rating: 3 A
- insulation resistance:  $5 \times 10^3 \text{ M}\Omega$  initially,  $1 \times 10^3 \text{ M}\Omega$  after tests
- withstanding voltage: 1000 V rms (sea level)

#### MECHANICAL PERFORMANCE

- insertion force: 1,50 N max. per individual power contact (mating)
- withdrawal force: 0,30 N max. per individual power contact (unmating)
- press-fit contact insertion: 65 N max. per pin
- press-fit pin withdrawal: 15 N min. per pin
- recommended hole diameter: 0,65-0,80 mm

#### ENVIRONMENTAL

- Operating temperature -55°C to + 125°C
- RoHs information, this product is compatible according to the European Union Directive 2002/95/IEC

#### PACKAGING

- Standard Tubes

#### PROCESSING INFORMATION

- Applicable process: press fit

#### REFERENCE DATA

- Product Specification GS-12-180
- Application Specification BUS-20-075

#### APPLICATION EQUIPMENT

- for application equipment, check out the application equipment table on page 217-223



### MATING DATA

- Receptacle, right angle, press-fit, page 101
  - part number 88949-102LF
- Receptacle, right angle, solder-to-board, page 99
  - part number 89039-101LF
- Receptacle, right angle, Pin-in-Paste, page 103
  - part number 72651-101LF

### TYPICAL APPLICATIONS

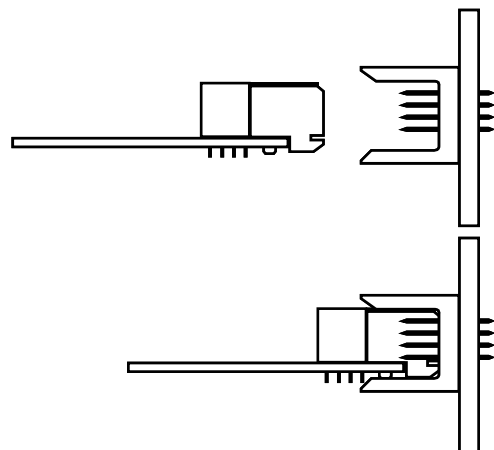

# Header, 4 row power, straight, press-fit, wide body

## PRODUCT

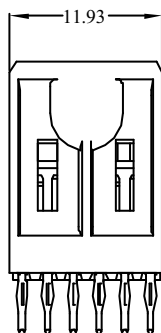
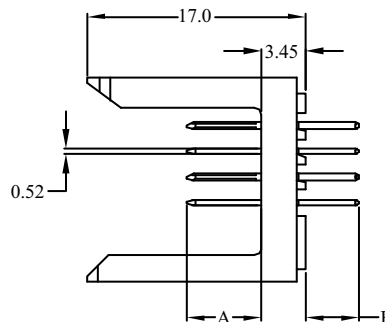
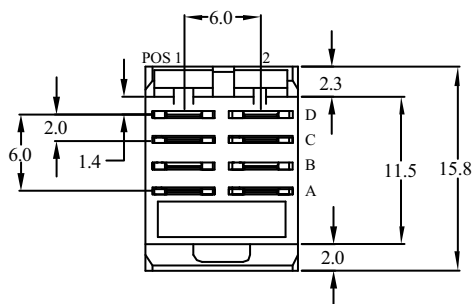

PCB pattern P6, see chapter PCB layouts

## PARTNUMBERS

**70236 - 101LF**

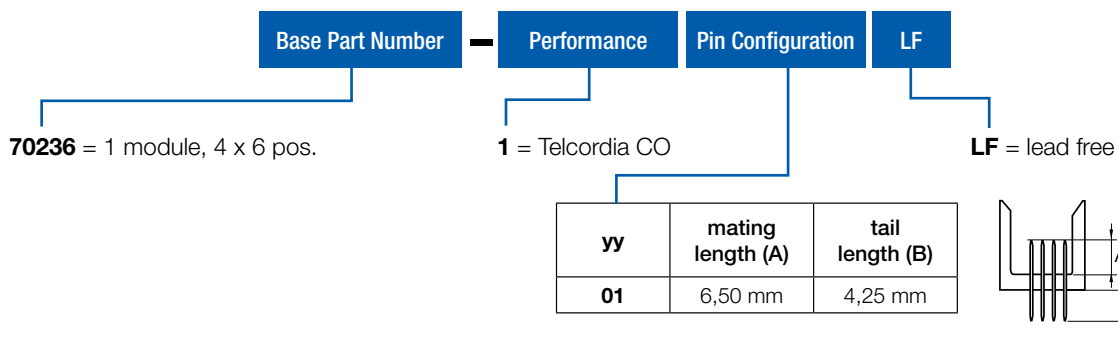

**Note:** for other special patterns or loadings, please check drawings, all other configurations on request only

## Header, 4 row, power, straight, solder to board, narrow body

### FEATURES

- In accordance with IEC 60917 and IEC 61076-4-104 (Futurebus+)
- 4 row 2 power blades contacts
- Narrow body housing
- 12 mm power modules are form- and fit interchangeable with signal modules on same footprint



### TECHNICAL DATA

#### PHYSICAL

- spacing: 2,00 mm x 2,00 mm
- housing: glass-filled LCP (30% glass), colour natural
- flammability rating: UL 94 V-0
- contact material: phosphor bronze
- performance level: Telcordia CO

#### ELECTRICAL

- current rating: 3 A
- insulation resistance:  $5 \times 10^3 \text{ M}\Omega$  initially,  $1 \times 10^3 \text{ M}\Omega$  after tests
- withstanding voltage: 1000 V rms (sea level)

#### MECHANICAL PERFORMANCE

- insertion force: 1,50 N max. per individual power contact (mating)
- withdrawal force: 0,30 N max. per individual power contact (unmating)
- recommended hole diameter: 0,65-0,80 mm

#### ENVIRONMENTAL

- Operating temperature  $-55^\circ\text{C}$  to  $+125^\circ\text{C}$
- RoHs information, this product is compatible according to the European Union Directive 2002/95/IEC

#### PACKAGING

- Standard Tubes

#### PROCESSING INFORMATION

- Applicable process: wave, IR, vapor phase

#### REFERENCE DATA

- Product Specification GS-12-180
- Application Specification BUS-20-075

#### APPLICATION EQUIPMENT

- for application equipment, check out the application equipment table on page 217-223

### MATING DATA

- Receptacle, right angle, press-fit, page 101
  - part number 88949-102LF
- Receptacle, right angle, solder-to-board, page 99
  - part number 89039-101LF
- Receptacle, right angle, Pin-in-Paste, page 103
  - part number 72651-101LF

### TYPICAL APPLICATIONS

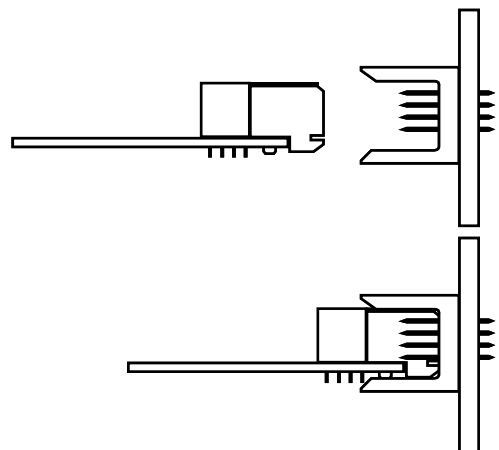

# Header, 4 row, power, straight, solder to board, narrow body

## PRODUCT

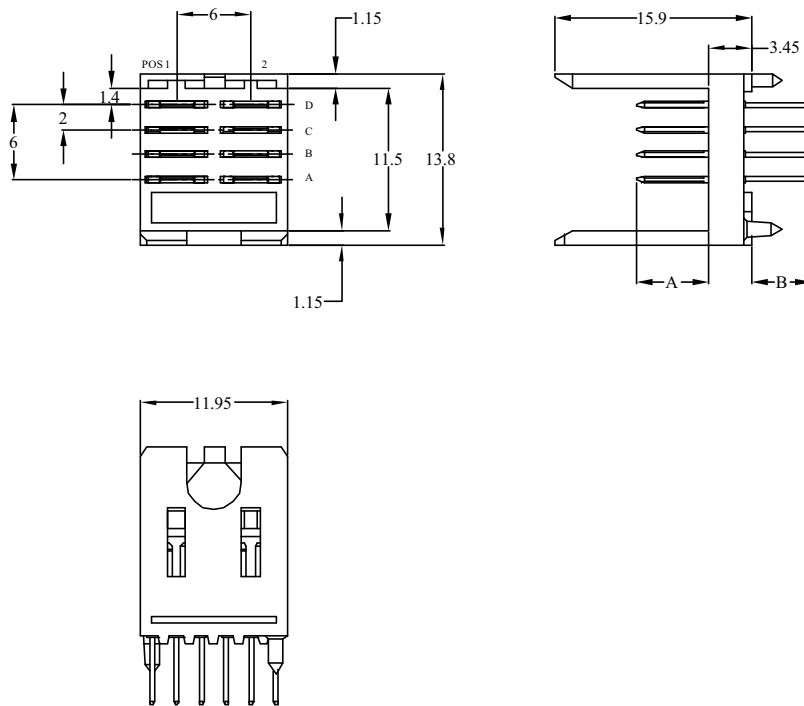

PCB pattern P3, see chapter PCB layouts

## PARTNUMBERS

70278 - 101LF

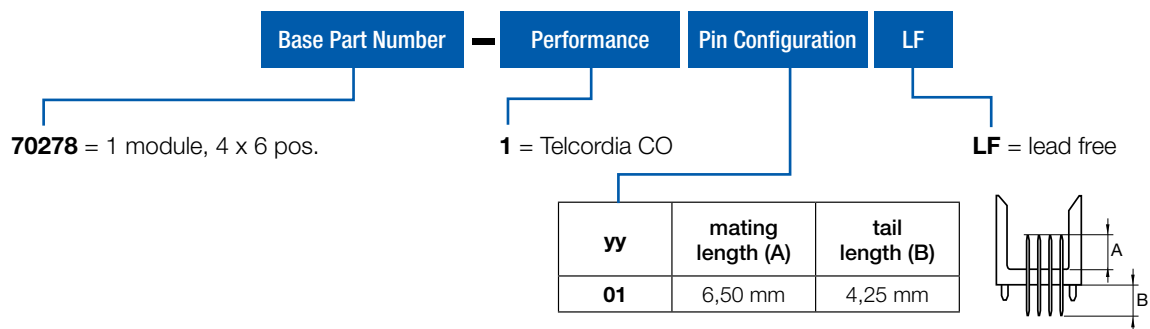

**Note:** for other special patterns or loadings, please check drawings, all other configurations on request only

## Header, 4 row, power, straight, press-fit, narrow body

### FEATURES

- In accordance with IEC 60917 and IEC 61076-4-104 (Futurebus+)
- 4 x 2 power blades contacts
- Narrow body housing
- 12 mm power modules are form- and fit interchangeable with signal modules on same footprint
- Eye the needle press-fit contact

### TECHNICAL DATA

#### PHYSICAL

- spacing: 2,00 mm x 2,00 mm
- housing: glass-filled LCP (30% glass), colour natural
- flammability rating: UL 94 V-0
- contact material: phosphor bronze
- performance level: Telcordia CO

#### ELECTRICAL

- current rating: 3 A
- insulation resistance:  $5 \times 10^3 \text{ M}\Omega$  initially,  $1 \times 10^3 \text{ M}\Omega$  after tests
- withstanding voltage: 1000 V rms (sea level)

#### MECHANICAL PERFORMANCE

- insertion force: 1,50 N max. per individual power contact (mating)
- withdrawal force: 0,30 N max. per individual power contact (unmating)
- press-fit contact insertion: 65 N max. per pin
- press-fit pin withdrawal: 15 N min. per pin
- recommended hole diameter: 0,65-0,80 mm

#### ENVIRONMENTAL

- Operating temperature  $-55^\circ\text{C}$  to  $+125^\circ\text{C}$
- RoHs information, this product is compatible according to the European Union Directive 2002/95/IEC

#### PACKAGING

- Standard Tubes

#### PROCESSING INFORMATION

- Applicable process: press fit

#### REFERENCE DATA

- Product Specification GS-12-180
- Application Specification BUS-20-075

#### APPLICATION EQUIPMENT

- for application equipment, check out the application equipment table on page 217-223

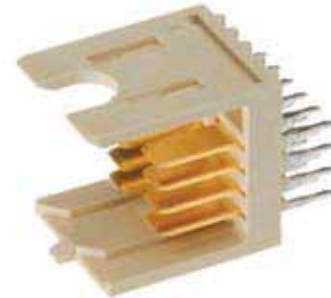

### MATING DATA

- Receptacle, right angle, press-fit, page 101
  - part number 88949-102LF
- Receptacle, right angle, solder-to-board, page 99
  - part number 89039-101LF
- Receptacle, right angle, Pin-in-Paste, page 103
  - part number 72651-101LF

### TYPICAL APPLICATIONS

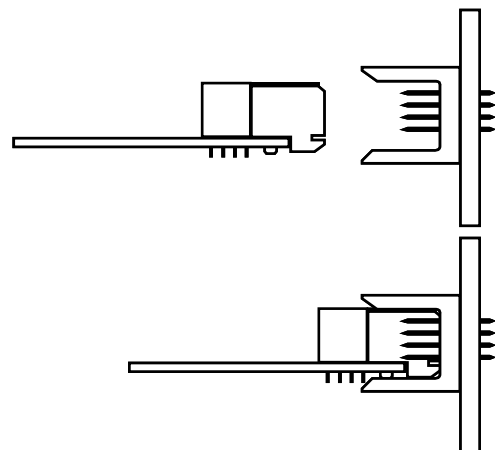

# Header, 4 row, power, straight, press-fit, narrow body

## PRODUCT

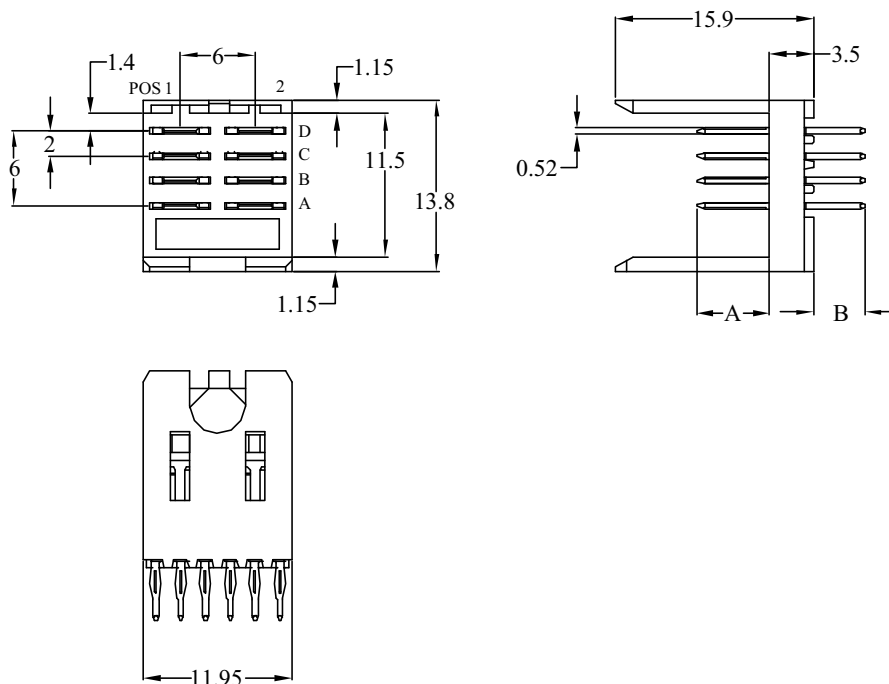

PCB pattern P4, see chapter PCB layouts

## PARTNUMBERS

85830 - 101LF

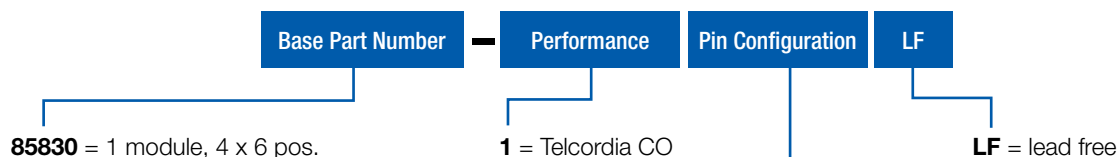

yy	mating length (A)	tail length (B)
01	6,50 mm	4,30 mm

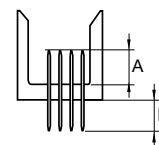

**Note:** for other special patterns or loadings, please check drawings, all other configurations on request only

## Receptacle, 4 row, power, right angle, solder to board

### FEATURES

- In accordance with IEC 60917 and IEC 61076-4-104 (Futurebus+)
- 4 x 2 dual beam power blades contacts
- 12 mm power modules are form- and fit interchangeable with signal modules on same footprint
- Modular design guarantees flexibility
- Stackable end-to-end without loss of position
- Stackable with other METRAL® function modules (power, I/O)

### TECHNICAL DATA

#### PHYSICAL

- spacing: 2,00 mm x 2,00 mm
- housing: glass-filled LCP (30% glass), colour natural
- flammability rating: UL 94 V-0
- contact material: phosphor bronze
- performance level: Telcordia CO

#### ELECTRICAL

- current rating: 3 A
- insulation resistance:  $5 \times 10^3 \text{ M}\Omega$  initially,  $1 \times 10^3 \text{ M}\Omega$  after tests
- withstanding voltage: 1000 V rms (sea level)

#### MECHANICAL PERFORMANCE

- insertion force: 1,50 N max. per individual power contact (mating)
- withdrawal force: 0,30 N max. per individual power contact (unmating)
- recommended hole diameter: 0,65-0,80 mm

#### ENVIRONMENTAL

- Operating temperature -55°C to + 125°C
- RoHs information, this product is compatible according to the European Union Directive 2002/95/IEC

#### PACKAGING

- Standard Tubes

#### PROCESSING INFORMATION

- Applicable process: wave, IR, vapor phase

#### REFERENCE DATA

- Product Specification GS-12-453

#### APPLICATION EQUIPMENT

- for application equipment, check out the application equipment table on page 217-223



### MATING DATA

#### Header, straight, press-fit, page 93

- 1 module – part number 70236-101LF

#### Header, straight, solder-to-board, page 91

- 1 module – part number 88960-101LF

### TYPICAL APPLICATIONS

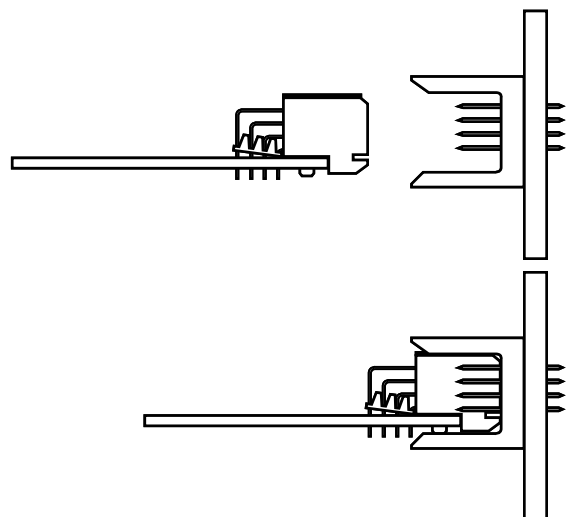



# Receptacle, 4 row, power, right angle, solder to board

## PRODUCT

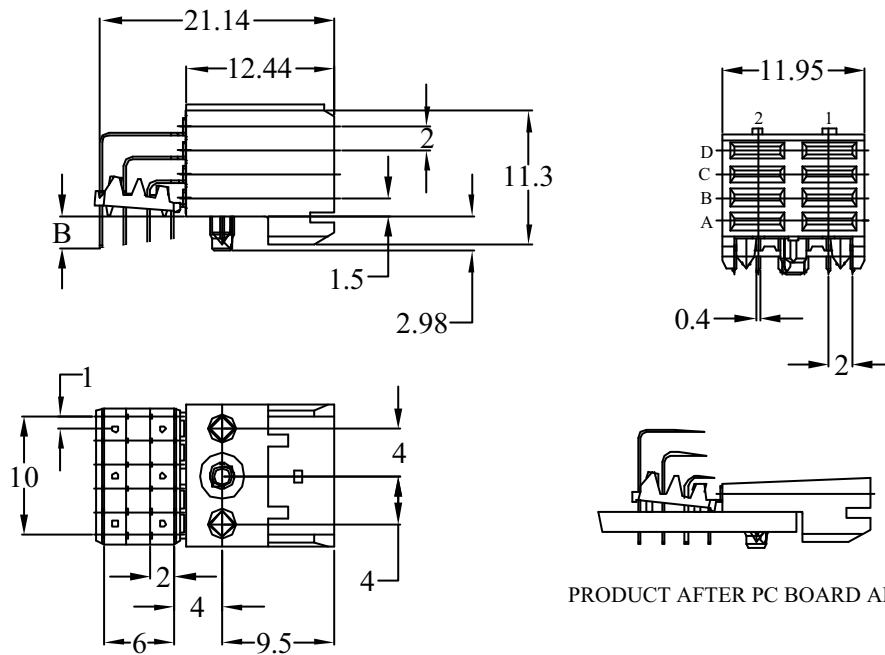

PRODUCT AFTER PC BOARD APPLICATION.

PCB pattern P1, see chapter PCB layouts

## PARTNUMBERS

89039 - 1yyLF

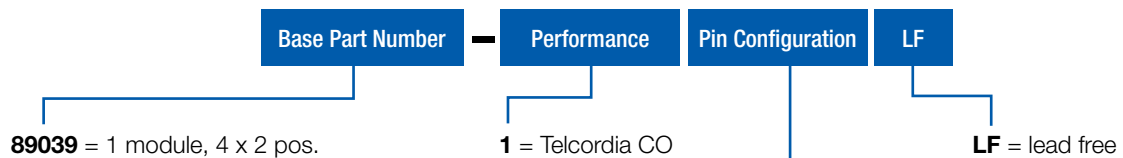

yy	Tail length (B)	PCB Thickness
02	2,73 mm	1,60 mm
11	3,53 mm	2,40 mm

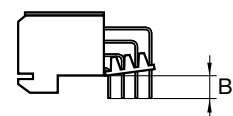

**Note:** for other special patterns or loadings, please check drawings, all other configurations on request only

## Receptacle, 4 row, power, right angle, press-fit

### FEATURES

- In accordance with IEC 60917 and IEC 61076-4-104 (Futurebus+)
- 4 x 2 dual beam power blades contacts
- 12 mm power modules are form- and fit interchangeable with signal modules on same footprint
- Modular design guarantees flexibility
- Stackable end-to-end without loss of position
- Stackable with other METRAL® function modules (power, I/O)
- Press block ensures accurate position of press-fit tails for easy mounting
- Eye the needle press-fit contact



### TECHNICAL DATA

#### PHYSICAL

- spacing: 2,00 mm x 2,00 mm
- housing: glass-filled LCP (30% glass), colour natural
- flammability rating: UL 94 V-0
- contact material: phosphor bronze
- performance level: Telcordia CO

#### ELECTRICAL

- current rating: 3 A
- insulation resistance:  $5 \times 10^3 \text{ M}\Omega$  initially,  $1 \times 10^3 \text{ M}\Omega$  after tests
- withstanding voltage: 1000 V rms (sea level)

#### MECHANICAL PERFORMANCE

- insertion force: 1,50 N max. per individual power contact (mating)
- withdrawal force: 0,30 N max. per individual power contact (unmating)
- press-fit contact insertion: 55 N max. per pin
- press-fit pin withdrawal: 15 N min. per pin
- recommended hole diameter: 0,65-0,80 mm

#### ENVIRONMENTAL

- Operating temperature  $-55^\circ\text{C}$  to  $+125^\circ\text{C}$
- RoHs information, this product is compatible according to the European Union Directive 2002/95/IEC

#### PACKAGING

- Standard Tubes

#### PROCESSING INFORMATION

- Applicable process: press fit

#### REFERENCE DATA

- Press-peg application, TA-0941
- Product Specification GS-12-453

#### APPLICATION EQUIPMENT

- for application equipment, check out the application equipment table on page 217-223

### MATING DATA

- Header, straight, press-fit, page 93
  - 1 module – part number 70236-101LF
- Header, straight, solder-to-board, page 91
  - 1 module – part number 88960-101LF

### TYPICAL APPLICATIONS

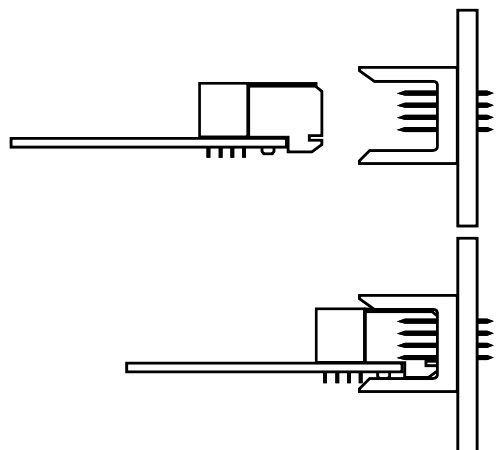

# Receptacle, 4 row, power, right angle, press-fit

## PRODUCT

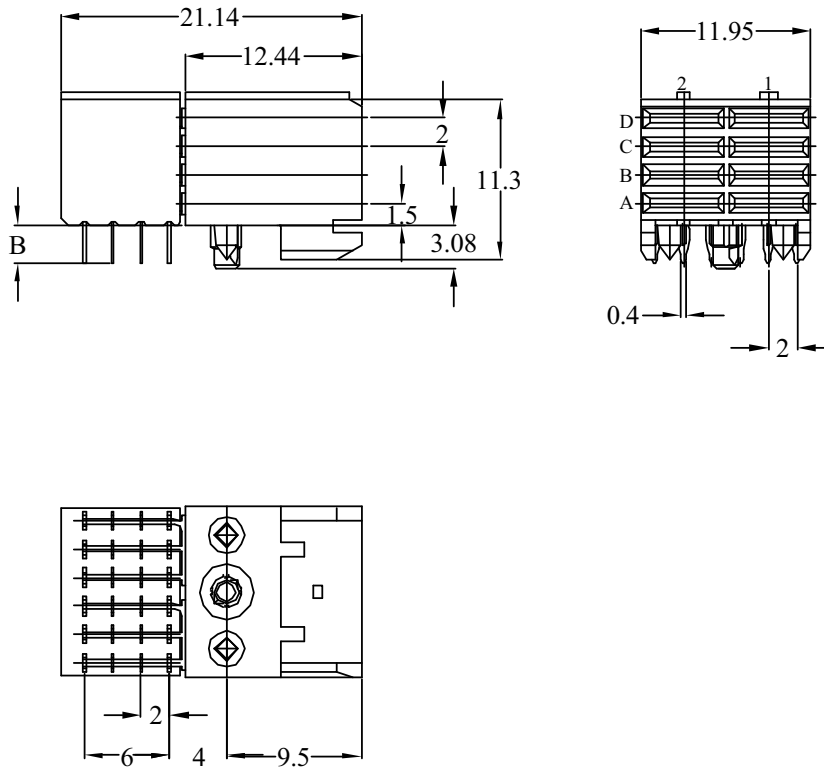

PCB pattern P1, see chapter PCB layouts

## PARTNUMBERS

88949 - 1yyLF

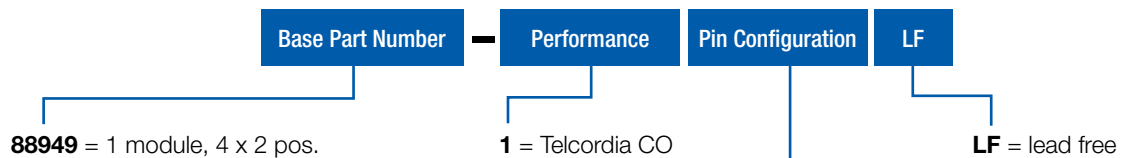

yy	Tail length (B)	PCB Thickness
<b>02</b>	2,73 mm	1,60 mm
<b>12</b>	3,53 mm	2,40 mm

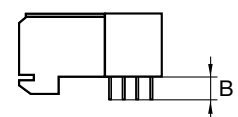

**Note:** blue marked in **tail length** is the preferred recommended standard for other special patterns or loadings, please check drawings, all other configurations on request only

## Receptacle, 4 row, power, right angle, pin-in-paste

### FEATURES

- In accordance with IEC 60917 and IEC 61076-4-104 (Futurebus+)
- 4 x 2 dual beam power blades contacts
- 12 mm power modules are form- and fit interchangeable with signal modules on same footprint
- Modular design guarantees flexibility
- Stackable end-to-end without loss of position
- Stackable with other METRAL® function modules (power, I/O)

### TECHNICAL DATA

#### PHYSICAL

- spacing: 2,00 mm x 2,00 mm
- housing: glass-filled LCP (30% glass), colour natural
- flammability rating: UL 94 V-0
- contact material: phosphor bronze
- performance level: Telcordia CO

#### ELECTRICAL

- current rating: 3 A
- insulation resistance:  $5 \times 10^3 \text{ M}\Omega$  initially,  $1 \times 10^3 \text{ M}\Omega$  after tests
- withstanding voltage: 1000 V rms (sea level)

#### MECHANICAL PERFORMANCE

- insertion force: 1,50 N max. per individual power contact (mating)
- withdrawal force: 0,30 N max. per individual power contact (unmating)
- recommended hole diameter: 0,65-0,80 mm

#### ENVIRONMENTAL

- Operating temperature -55°C to + 125°C
- RoHs information, this product is compatible according to the European Union Directive 2002/95/IEC

#### PACKAGING

- Standard Tubes

#### PROCESSING INFORMATION

- automatic Surface-mount reflow process, resistance for Lead Free reflow temperature

#### REFERENCE DATA

- Packaging specification GS-14-920
- Product Specification GS-12-453

#### APPLICATION EQUIPMENT

- for application equipment, check out the application equipment table on page 217-223

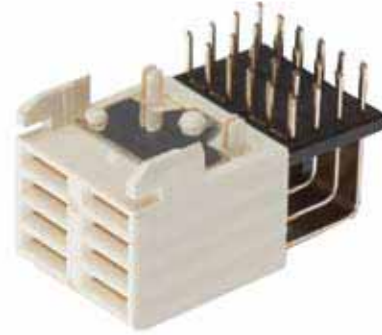

### MATING DATA

#### Header, straight, press-fit, page 93

- 1 module – part number 70236-101LF

#### Header, straight, solder-to-board, page 91

- 1 module – part number 88960-101LF

### TYPICAL APPLICATIONS

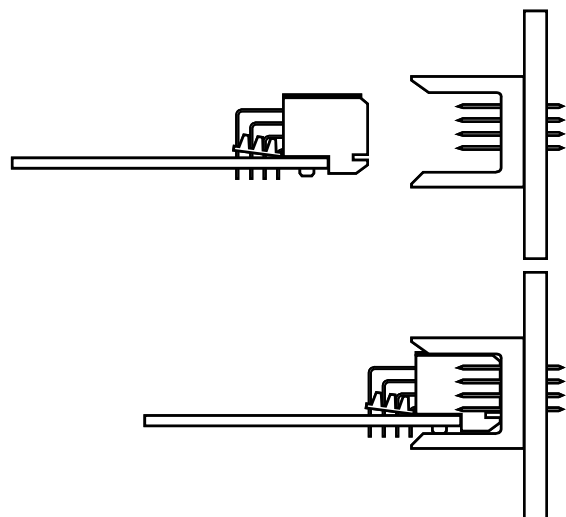

# Receptacle, 4 row, power, right angle, pin-in-paste

## PRODUCT

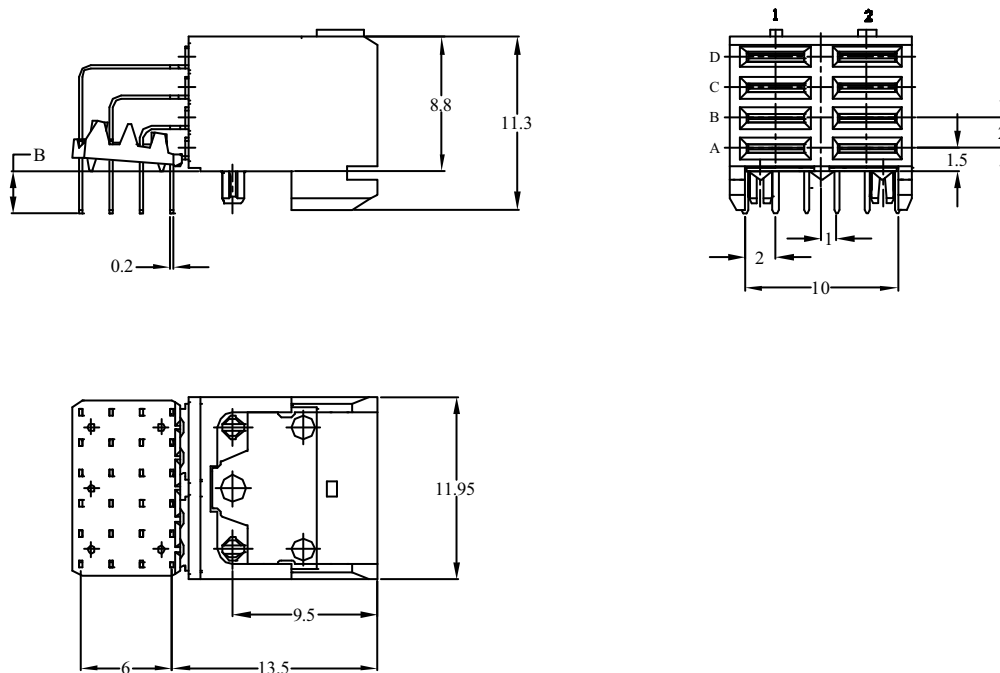

PCB pattern P1, see chapter PCB layouts

## PARTNUMBERS

72651 - 1yyLF

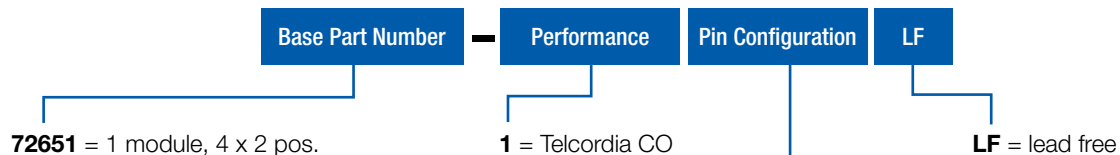

yy	Tail length (B)	PCB Thickness
02	2,73 mm	1,60 mm
11	3,53 mm	2,40 mm

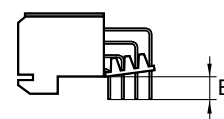

**Note:** blue marked in **tail length** is the preferred recommended standard for other special patterns or loadings, please check drawings, all other configurations on request only

## Header, 5 row, power, straight, solder to board, wide body

### FEATURES

- In accordance with IEC 60917 and IEC 61076-4-104 (Futurebus+)
- 5 x 2 power blades contacts
- 12 mm power modules are form- and fit interchangeable with signal modules on same footprint

### TECHNICAL DATA

#### PHYSICAL

- spacing: 2,00 mm x 2,00 mm
- housing: glass-filled LCP (30% glass), colour natural
- flammability rating: UL 94 V-0
- contact material: phosphor bronze
- performance level: Telcordia CO

#### ELECTRICAL

- current rating: 3 A
- insulation resistance: 5x10<sup>3</sup> MΩ initially, 1x10<sup>3</sup> MΩ after tests
- withstanding voltage: 1000 V rms (sea level)

#### MECHANICAL PERFORMANCE

- insertion force: 1,50 N max. per individual power contact (mating)
- withdrawal force: 0,30 N max. per individual power contact (unmating)
- recommended hole diameter: 0,65-0,80 mm

#### ENVIRONMENTAL

- Operating temperature -55°C to + 125°C
- RoHs information, this product is compatible according to the European Union Directive 2002/95/IEC

#### PACKAGING

- Standard Tubes

#### PROCESSING INFORMATION

- Applicable process: wave, IR, vapor phase

#### REFERENCE DATA

- Product Specification GS-12-180
- Application Specification BUS-20-075

#### APPLICATION EQUIPMENT

- for application equipment, check out the application equipment table on page 217-223



### MATING DATA

- Receptacle, right angle, press-fit, page 109
  - part number 85876-1yyLF
- Receptacle, right angle, solder-to-board, page 111
  - part number 89096-1yyLF
- Receptacle, right angle, Pin-in-Paste, page 113
  - part number 63793-101LF

### TYPICAL APPLICATIONS

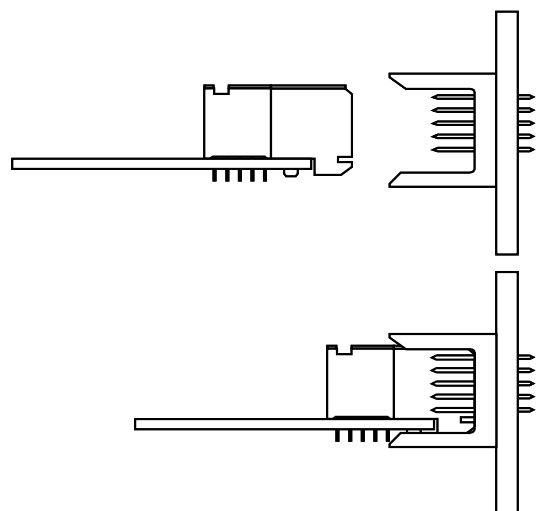

# Header, 5 row, power, straight, solder to board, wide body

## PRODUCT

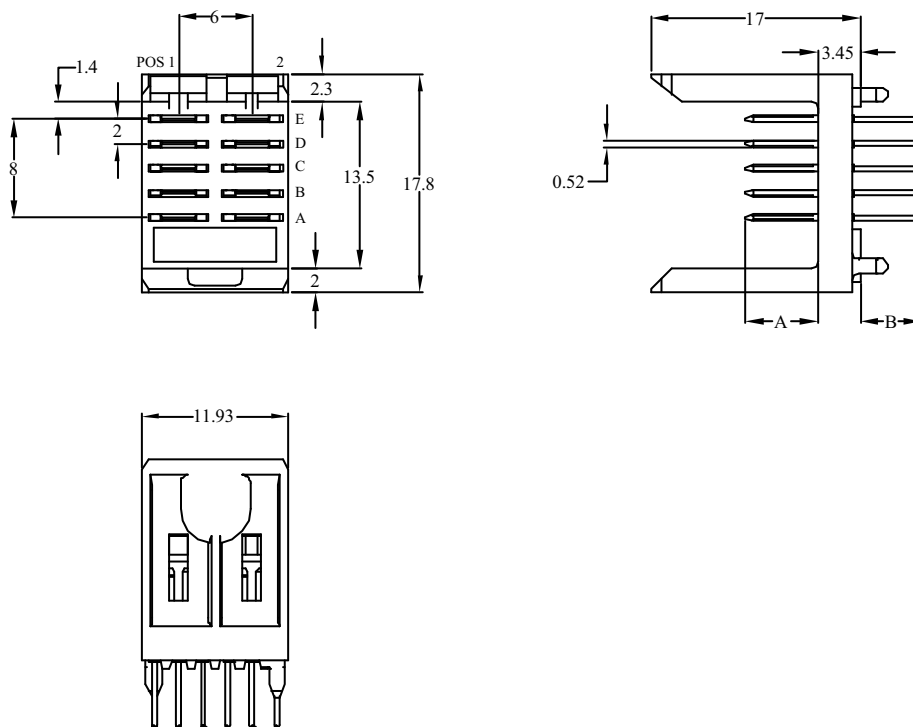

PCB pattern P16, see chapter PCB layouts

## PARTNUMBERS

63346 - 104LF

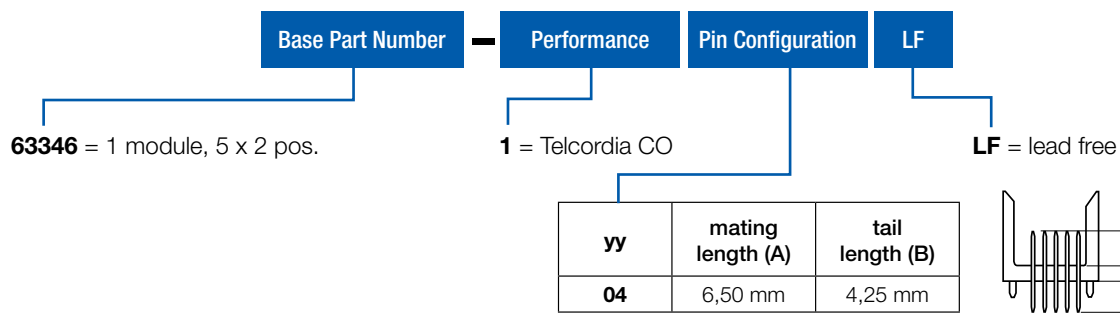

**Note:** for other special patterns or loadings, please check drawings, all other configurations on request only

## Header, 5 row, power, straight, press-fit, wide body

### FEATURES

- In accordance with IEC 60917 and IEC 61076-4-104 (Futurebus+)
- 5 x 2 power blades contacts
- 12 mm power modules are form- and fit interchangeable with signal modules on same footprint
- Eye the needle press-fit contac

### TECHNICAL DATA

#### PHYSICAL

- spacing: 2,00 mm x 2,00 mm
- housing: glass-filled LCP (30% glass), colour natural
- flammability rating: UL 94 V-0
- contact material: phosphor bronze
- performance level: Telcordia CO

#### ELECTRICAL

- current rating: 3 A
- insulation resistance: 5x10<sup>3</sup> MΩ initially, 1x10<sup>3</sup> MΩ after tests
- withstanding voltage: 1000 V rms (sea level)

#### MECHANICAL PERFORMANCE

- insertion force: 1,50 N max. per individual power contact (mating)
- withdrawal force: 0,30 N max. per individual power contact (unmating)
- press-fit contact insertion: 65 N max. per pin
- press-fit pin withdrawal: 15 N min. per pin
- recommended hole diameter: 0,65-0,80 mm

#### ENVIRONMENTAL

- Operating temperature -55°C to + 125°C
- RoHs information, this product is compatible according to the European Union Directive 2002/95/IEC

#### PACKAGING

- Standard Tubes

#### PROCESSING INFORMATION

- Applicable process: press fit

#### REFERENCE DATA

- Product Specification GS-12-180
- Application Specification BUS-20-075

#### APPLICATION EQUIPMENT

- for application equipment, check out the application equipment table on page 217-223



### MATING DATA

- Receptacle, right angle, press-fit, page 109
  - part number 85876-1yyLF
- Receptacle, right angle, solder-to-board, page 111
  - part number 89096-1yyLF
- Receptacle, right angle, Pin-in-Paste, page 113
  - part number 63793-101LF

### TYPICAL APPLICATIONS

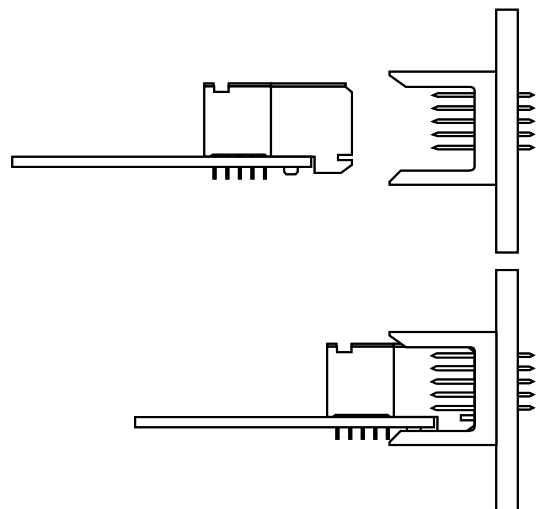



# Header, 5 row, power, straight, press-fit, wide body

## PRODUCT

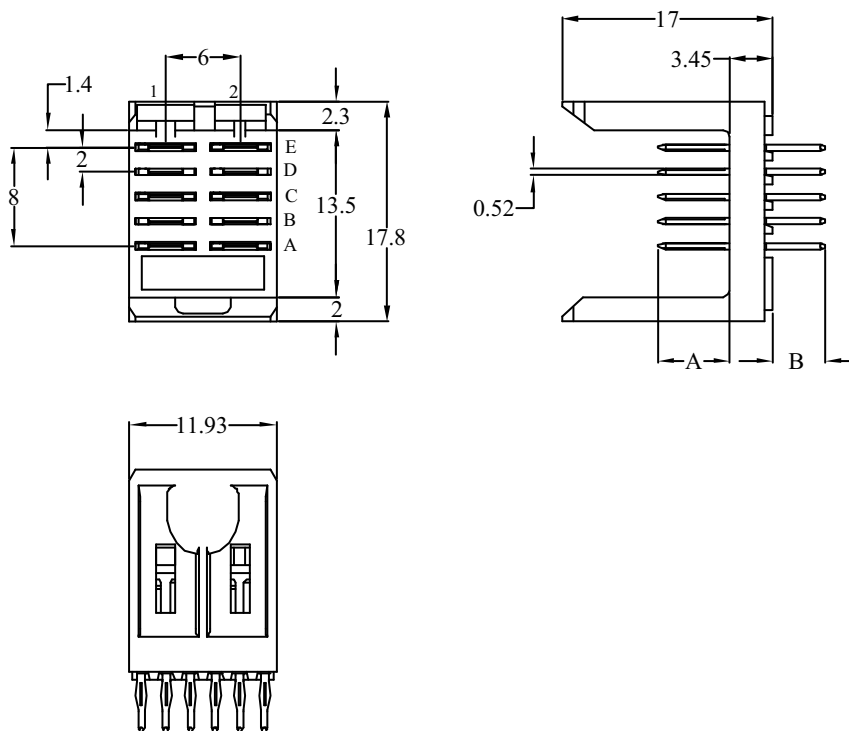

PCB pattern P7, see chapter PCB layouts

## PARTNUMBERS

89099 - 111LF

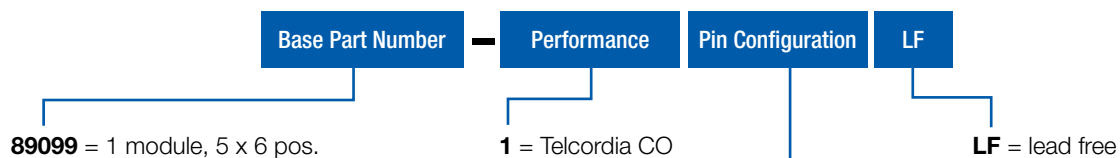

yy	mating length (A)	tail length (B)
11	6,50 mm	4,30 mm

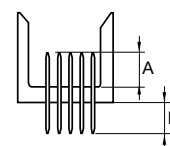

**Note:** for other special patterns or loadings, please check drawings, all other configurations on request only

## Receptacle, 5 row, power, right angle, solder to board

### FEATURES

- In accordance with IEC 60917 and IEC 61076-4-104 (Futurebus+)
- 5 x 2 dual beam power blades contacts
- 12 mm power modules are form- and fit interchangeable with signal modules on same footprint
- Modular design guarantees flexibility
- Stackable end-to-end without loss of position
- Stackable with other METRAL® function modules (power, I/O)

### TECHNICAL DATA

#### PHYSICAL

- spacing: 2,00 mm x 2,00 mm
- housing: glass-filled LCP (30% glass), colour natural
- flammability rating: UL 94 V-0
- contact material: phosphor bronze
- performance level: Telcordia CO

#### ELECTRICAL

- current rating: 3 A
- insulation resistance:  $5 \times 10^3 \text{ M}\Omega$  initially,  $1 \times 10^3 \text{ M}\Omega$  after tests
- withstanding voltage: 1000 V rms (sea level)

#### MECHANICAL PERFORMANCE

- insertion force: 1,50 N max. per individual power contact (mating)
- withdrawal force: 0,30 N max. per individual power contact (unmating)
- press-fit contact insertion: 55 N max. per pin
- press-fit pin withdrawal: 15 N min. per pin
- recommended hole diameter: 0,65-0,80 mm

#### ENVIRONMENTAL

- Operating temperature -55°C to + 125°C
- RoHs information, this product is compatible according to the European Union Directive 2002/95/IEC

#### PACKAGING

- Standard Tubes

#### PROCESSING INFORMATION

- Applicable process: wave, IR, vapor phase

#### REFERENCE DATA

- Product Specification GS-12-453

#### APPLICATION EQUIPMENT

- for application equipment, check out the application equipment table on page 217-223



### MATING DATA

- Header, straight, press-fit, page 107

- 1 module – part number 89099-111LF

- Header, straight, solder-to-board, page 105

- 1 module – part number 63346-104LF

### TYPICAL APPLICATIONS

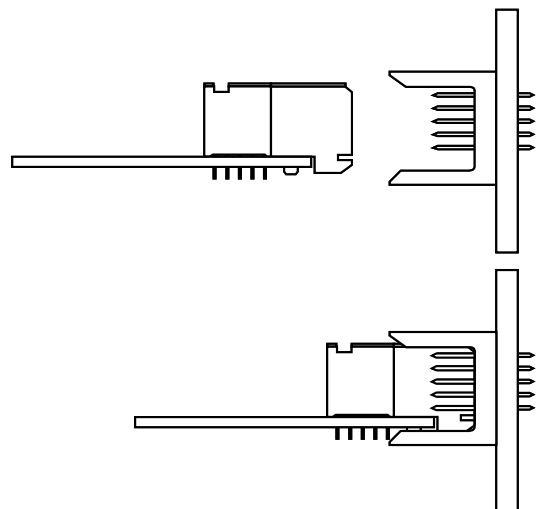

# Receptacle, 5 row, power, right angle, solder to board

## PRODUCT

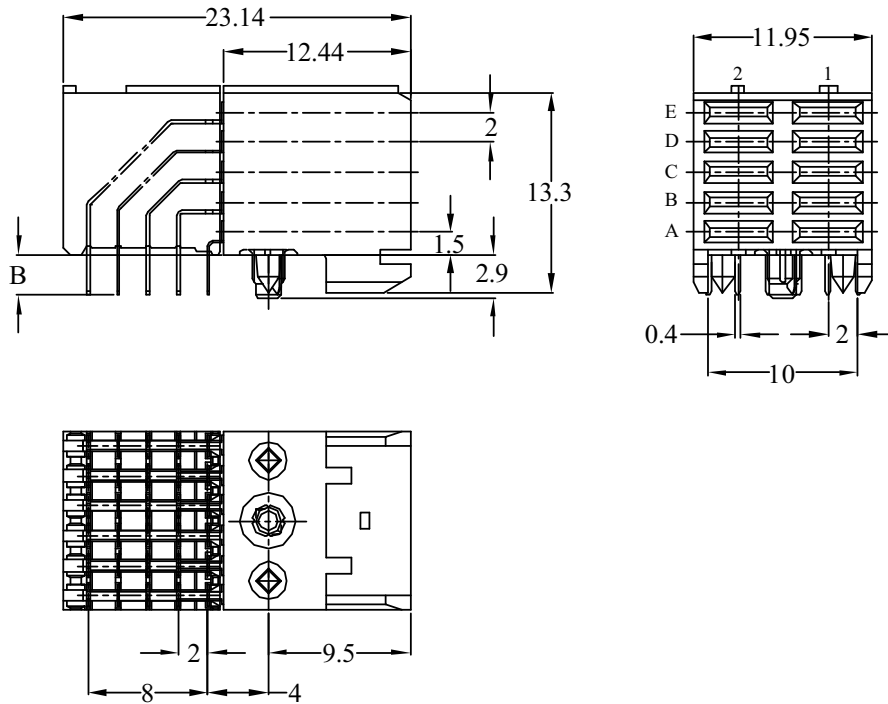

PCB pattern P2, see chapter PCB layouts

## PARTNUMBERS

85876 - 1yyLF

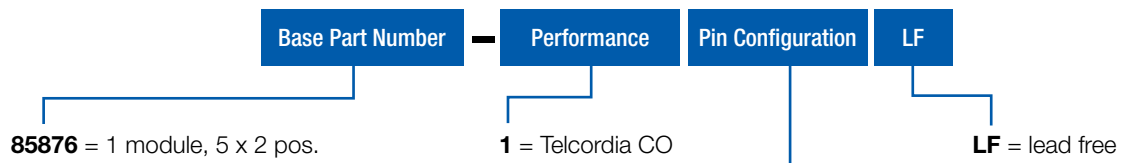

yy	Tail length (B)	PCB Thickness
02	2,73 mm	1,60 mm
12	3,53	2,40

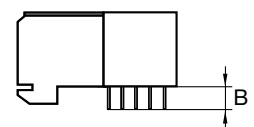

**Note:** blue marked in **tail length** is the preferred recommended standard for other special patterns or loadings, please check drawings, all other configurations on request only

## Receptacle, 5 row, power, right angle, press-fit

### FEATURES

- In accordance with IEC 60917 and IEC 61076-4-104 (Futurebus+)
- 5 x 2 dual beam power blades contacts
- 12 mm power modules are form- and fit interchangeable with signal modules on same footprint
- Modular design guarantees flexibility
- Stackable end-to-end without loss of position
- Stackable with other METRAL® function modules (power, I/O)
- Press block ensures accurate position of press-fit tails for easy mounting
- Eye the needle press-fit contact

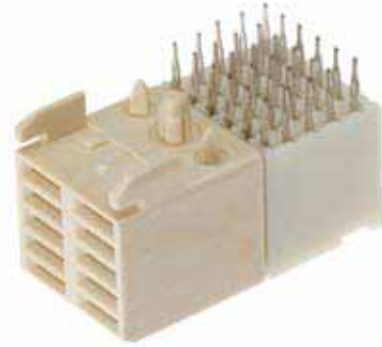

### TECHNICAL DATA

#### PHYSICAL

- spacing: 2,00 mm x 2,00 mm
- housing: glass-filled LCP (30% glass), colour natural
- flammability rating: UL 94 V-0
- contact material: phosphor bronze
- performance level: Telcordia CO

#### ELECTRICAL

- current rating: 3 A
- insulation resistance:  $5 \times 10^3 \text{ M}\Omega$  initially,  $1 \times 10^3 \text{ M}\Omega$  after tests
- withstanding voltage: 1000 V rms (sea level)

#### MECHANICAL PERFORMANCE

- insertion force: 1,50 N max. per individual power contact (mating)
- withdrawal force: 0,30 N max. per individual power contact (unmating)

- press-fit contact insertion: 55 N max. per pin
- press-fit pin withdrawal: 15 N min. per pin
- recommended hole diameter: 0,65-0,80 mm

#### ENVIRONMENTAL

- Operating temperature -55°C to + 125°C
- RoHs information, this product is compatible according to the European Union Directive 2002/95/IEC

#### PACKAGING

- Standard Tubes

#### PROCESSING INFORMATION

- Applicable process: press fit

#### REFERENCE DATA

- Press-peg application, TA-0941
- Product Specification GS-12-453

#### APPLICATION EQUIPMENT

- for application equipment, check out the application equipment table on page 217-223

### MATING DATA

- Header, straight, press-fit, page 107

- 1 module – part number 89099-111LF

- Header, straight, solder-to-board, page 105

- 1 module – part number 63346-104LF

### TYPICAL APPLICATIONS

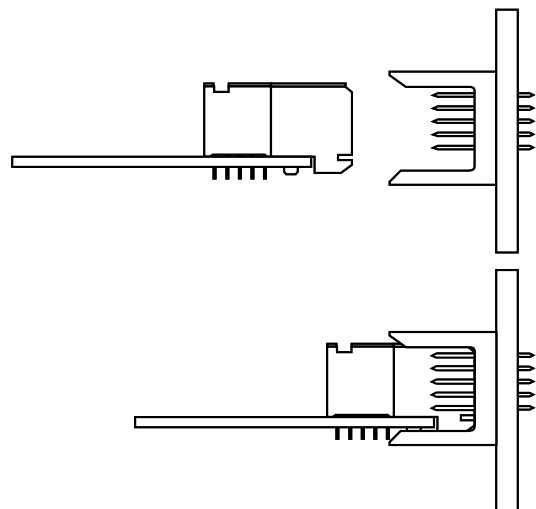

# Receptacle, 5 row, power, right angle, press-fit

## PRODUCT

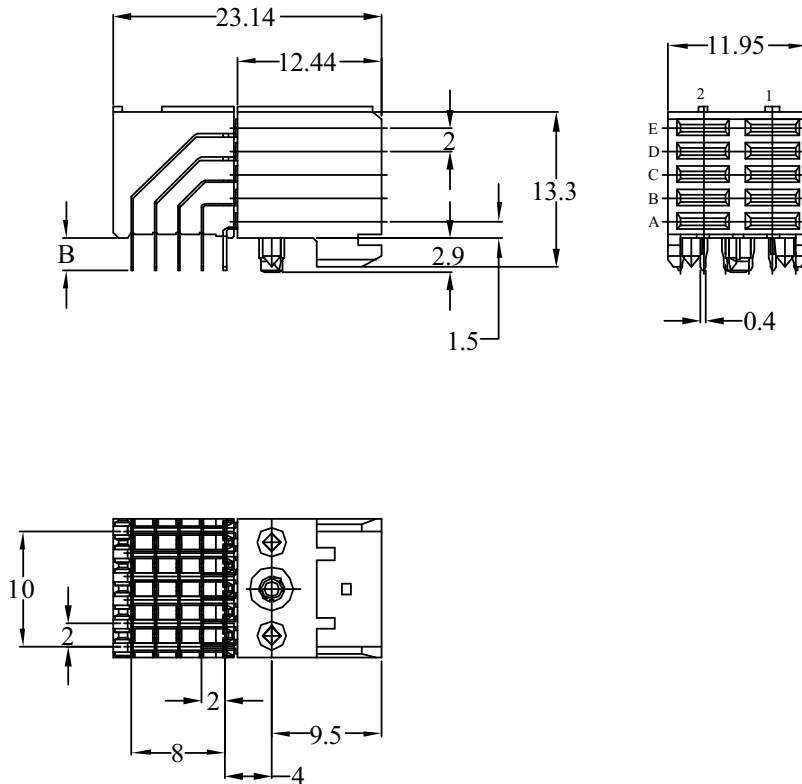

PCB pattern P2, see chapter PCB layouts

## PARTNUMBERS

89096 - 1yyLF

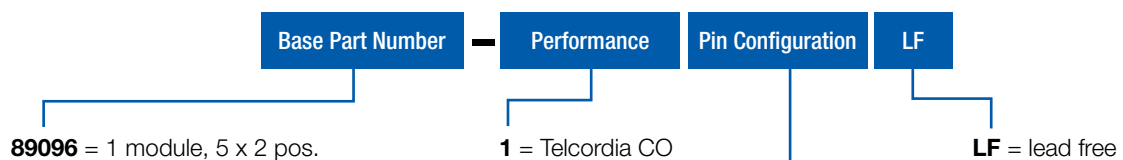

yy	Tail length (B)	PCB Thickness
02	2,73 mm	1,60 mm
12	3,53 mm	2,40 mm

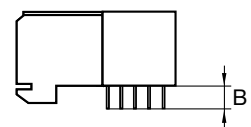

**Note:** blue marked in **tail length** is the preferred recommended standard for other special patterns or loadings, please check drawings, all other configurations on request only

## Receptacle, 5 row, power, right angle, pin-in-paste

### FEATURES

- In accordance with IEC 60917 and IEC 61076-4-104 (Futurebus+)
- 5 x 2 dual beam power blades contacts
- 12 mm power modules are form- and fit interchangeable with signal modules on same footprint
- Modular design guarantees flexibility
- Stackable end-to-end without loss of position
- Stackable with other METRAL® function modules (power, I/O)

### TECHNICAL DATA

#### PHYSICAL

- spacing: 2,00 mm x 2,00 mm
- housing: glass-filled LCP (30% glass), colour natural
- flammability rating: UL 94 V-0
- contact material: phosphor bronze
- performance level: Telcordia CO

#### ELECTRICAL

- current rating: 3 A
- insulation resistance:  $5 \times 10^3 \text{ M}\Omega$  initially,  $1 \times 10^3 \text{ M}\Omega$  after tests
- withstanding voltage: 1000 V rms (sea level)

#### MECHANICAL PERFORMANCE

- insertion force: 1,50 N max. per individual power contact (mating)
- withdrawal force: 0,30 N max. per individual power contact (unmating)
- recommended hole diameter: 0,65-0,80 mm

#### ENVIRONMENTAL

- Operating temperature -55°C to + 125°C
- RoHs information, this product is compatible according to the European Union Directive 2002/95/IEC

#### PACKAGING

- Standard Tubes

#### PROCESSING INFORMATION

- automatic Surface-mount reflow process, resistance for Lead Free reflow temperature

#### REFERENCE DATA

- Packaging specification GS-14-920
- Product Specification GS-12-453

#### APPLICATION EQUIPMENT

- for application equipment, check out the application equipment table on page 217-223

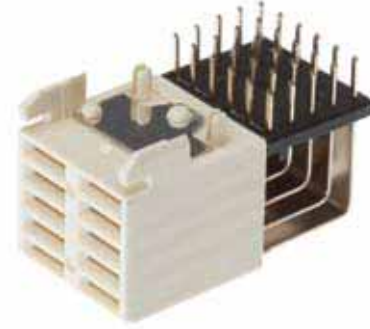

### MATING DATA

#### Header, straight, press-fit, page 107

- 1 module – part number 89099-111LF

#### Header, straight, solder-to-board, page 105

- 1 module – part number 63346-104LF

### TYPICAL APPLICATIONS

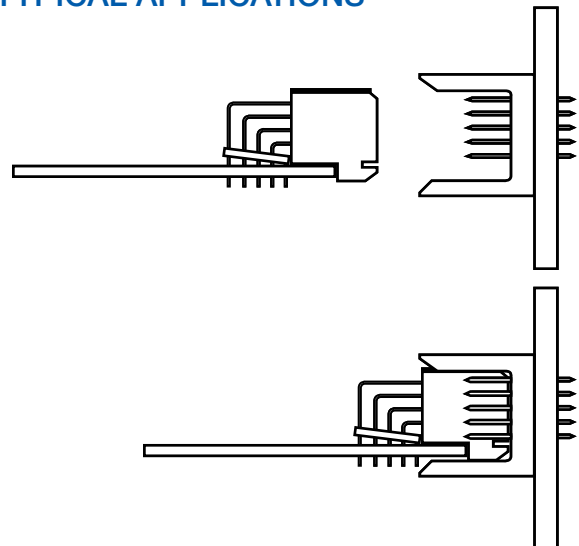

# Receptacle, 5 row, power, right angle, pin-in-paste

## PRODUCT

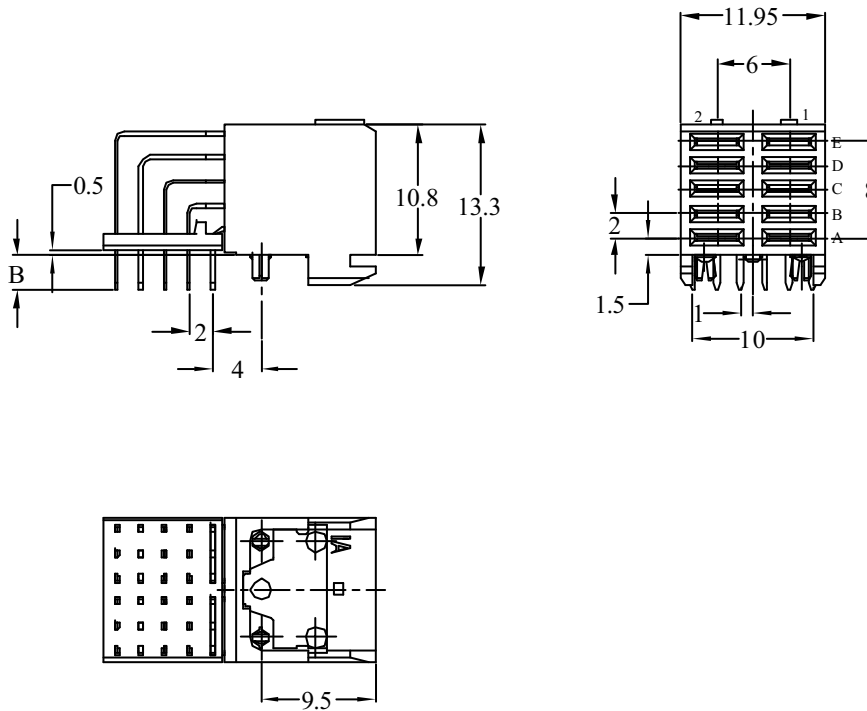

PCB pattern P2, see chapter PCB layouts

## PARTNUMBERS

**63793 - 101LF**

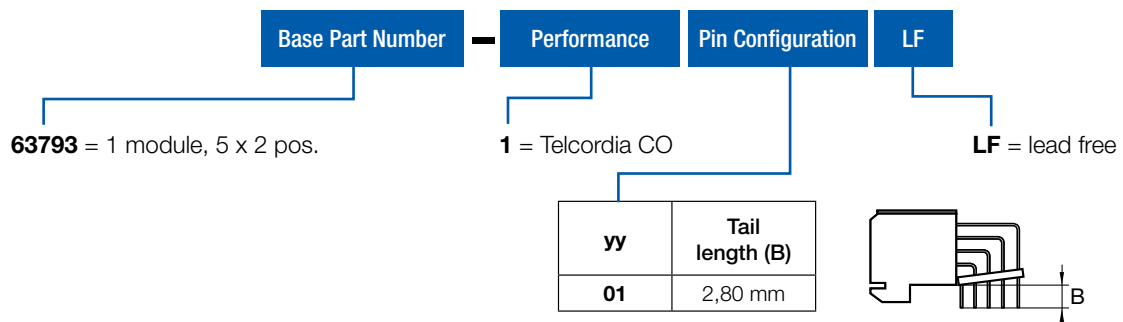





**Note:** for other special patterns or loadings, please check drawings, all other configurations on request only







## METRAL® POWER CONNECTORS REVERSED

-  Header, 4 row, right angle, wide body
-  Header, 4 row, right angle, narrow body
-  Receptacle, 4 row, straight
-  Header, 5 row, right angle, wide body
-  Receptacle, 5 row, straight

## Header, 4 row, power, right angle, solder to board, wide body

### FEATURES

- In accordance with IEC 60917 and IEC 61076-4-104 (Futurebus+)
- 4 x 2 power blades contacts
- 12 mm power modules are form- and fit interchangeable with signal modules on same footprint

### TECHNICAL DATA

#### PHYSICAL

- spacing: 2,00 mm x 2,00 mm
- housing: glass-filled LCP (30% glass), colour natural
- flammability rating: UL 94 V-0
- contact material: phosphor bronze
- performance level: Telcordia CO

#### ELECTRICAL

- current rating: 3 A
- insulation resistance:  $5 \times 10^3 \text{ M}\Omega$  initially,  $1 \times 10^3 \text{ M}\Omega$  after tests
- withstanding voltage: 1000 V rms (sea level)

#### MECHANICAL PERFORMANCE

- insertion force: 1,50 N max. per individual power contact (mating)
- withdrawal force: 0,30 N max. per individual power contact (unmating)
- recommended hole diameter: 0,65-0,80 mm

#### ENVIRONMENTAL

- Operating temperature  $-55^\circ\text{C}$  to  $+125^\circ\text{C}$
- RoHs information, this product is compatible according to the European Union Directive 2002/95/IEC

#### PACKAGING

- Standard Tubes

#### PROCESSING INFORMATION

- Applicable process: wave, IR, vapor phase

#### REFERENCE DATA

- Product specification: GS-12-446
- Application Specification BUS-20-075

#### APPLICATION EQUIPMENT

- for application equipment, check out the application equipment table on page 217-223



### MATING DATA

- Receptacle, straight, solder-to-board, page 123
- part number 85968-101LF

### TYPICAL APPLICATIONS

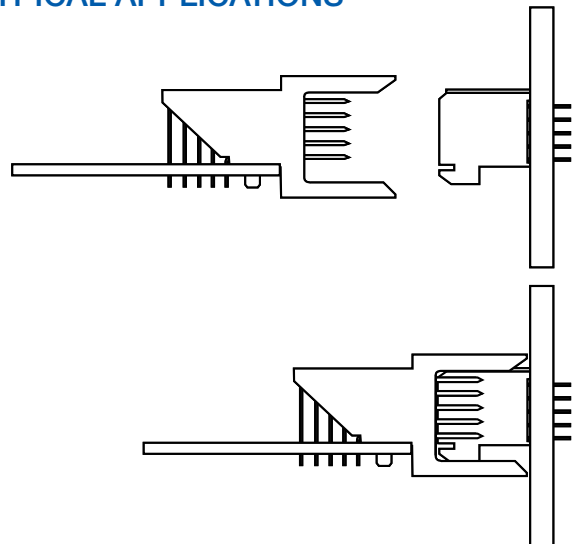

# Header, 4 row, power, right angle, solder to board, wide body

## PRODUCT

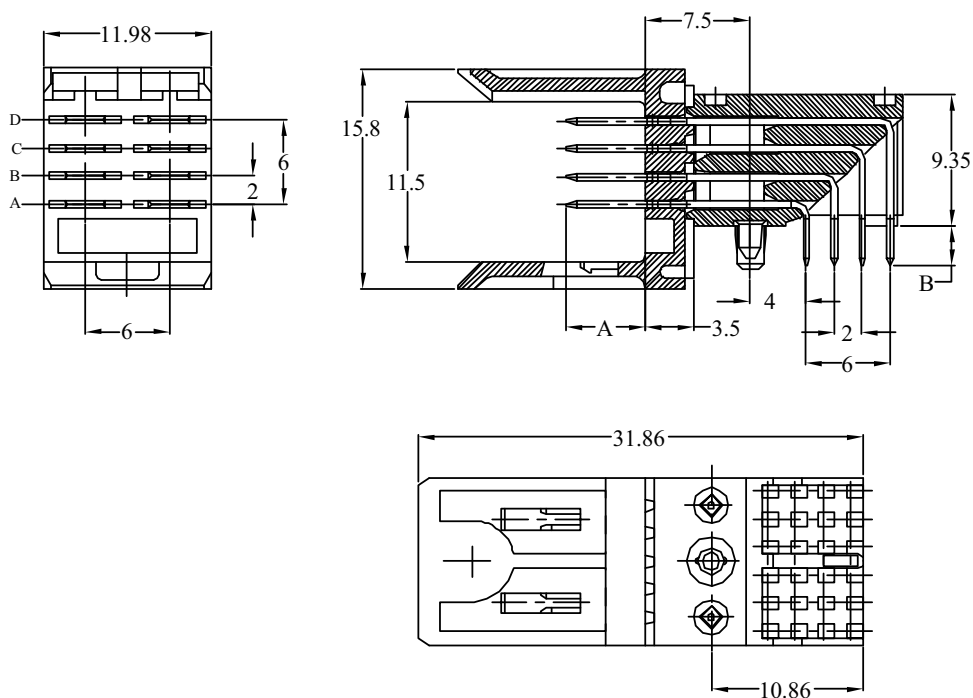

PCB pattern P1, see chapter PCB layouts

## PARTNUMBERS

**HM1K4 1 DAP000H6PLF**

Base Part Number	Type	no. of rows	no. of pos.	Configuration	000	Performance	Packaging	LF						
<b>HM1</b>	<b>K</b> = power header right angle	<b>4</b> = 4 row	<b>1</b> = 1 module (4 x 2 pos.)	<b>DAP</b> = solder to board <table border="1"> <thead> <tr> <th>mating length (A)</th> <th>tail length (B)</th> </tr> </thead> <tbody> <tr> <td>6,50 mm</td> <td>2,90 mm</td> </tr> <tr> <td colspan="2">1,6 mm PCB thickness</td> </tr> </tbody> </table>	mating length (A)	tail length (B)	6,50 mm	2,90 mm	1,6 mm PCB thickness			<b>H6</b> = Telcordia CO	<b>P</b> = trays	<b>LF</b> = lead free
mating length (A)	tail length (B)													
6,50 mm	2,90 mm													
1,6 mm PCB thickness														

**Note:** for other special patterns or loadings, please check drawings, all other configurations on request only

## Header, 4 row, power, right angle, press-fit, wide body

### FEATURES

- In accordance with IEC 60917 and IEC 61076-4-104 (Futurebus+)
- 4 x 2 power blades contacts
- 12 mm power modules are form- and fit interchangeable with signal modules on same footprint
- Eye the needle press-fit contact

### TECHNICAL DATA

#### PHYSICAL

- spacing: 2,00 mm x 2,00 mm
- housing: glass-filled LCP (30% glass), colour natural
- flammability rating: UL 94 V-0
- contact material: phosphor bronze
- performance level: Telcordia CO

#### ELECTRICAL

- current rating: 3 A
- insulation resistance:  $5 \times 10^3 \text{ M}\Omega$  initially,  $1 \times 10^3 \text{ M}\Omega$  after tests
- withstanding voltage: 1000 V rms (sea level)

#### MECHANICAL PERFORMANCE

- insertion force: 1,50 N max. per individual power contact (mating)
- withdrawal force: 0,30 N max. per individual power contact (unmating)
- press-fit contact insertion: 55 N max. per pin
- press-fit pin withdrawal: 15 N min. per pin
- recommended hole diameter: 0,65-0,80 mm

#### ENVIRONMENTAL

- Operating temperature -55°C to + 125°C
- RoHs information, this product is compatible according to the European Union Directive 2002/95/IEC

#### PACKAGING

- Trays

#### PROCESSING INFORMATION

- Applicable process: press fit

#### REFERENCE DATA

- Product specification: GS-12-445
- Application Specification BUS-20-075

#### APPLICATION EQUIPMENT

- for application equipment, check out the application equipment table on page 217-223



### MATING DATA

- Receptacle, straight, solder-to-board, page 123
- part number 85968-101LF

### TYPICAL APPLICATIONS

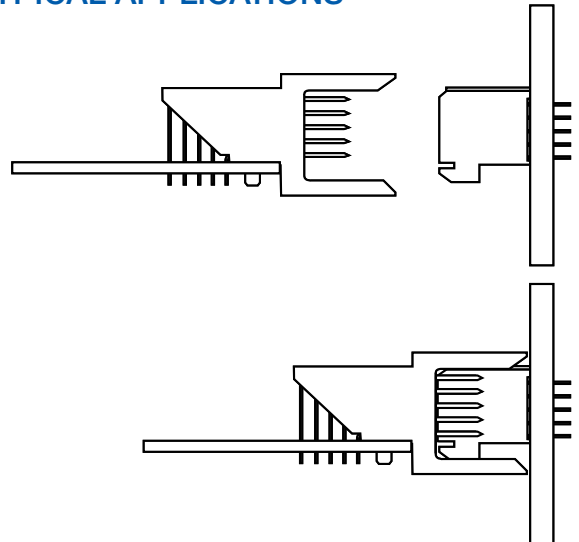

# Header, 4 row, power, right angle, press-fit, wide body

## PRODUCT

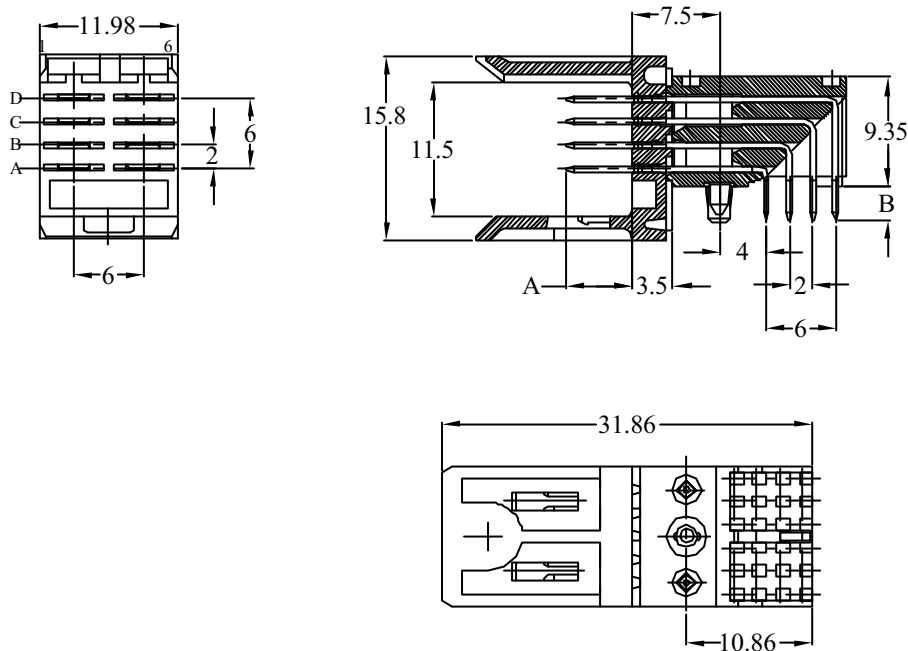

PCB pattern P1, see chapter PCB layouts

## PARTNUMBERS

**HM1K4 1 DDP000H6PLF**

Base Part Number	Type	no. of rows	no. of pos.	Configuration	000	Performance	Packaging	LF
------------------	------	-------------	-------------	---------------	-----	-------------	-----------	----

**HM1**

**K** = power header right angle

**4** = 4 row

**DDP** = press fit

mating length (A)	tail length (B)
6,50 mm	2,90 mm
1,6 mm PCB thickness	

**H6** = Telcordia CO

**LF** = lead free

**P** = trays

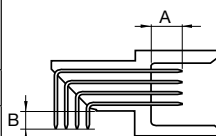

**1** = 1 module (4 x 2 pos.)

**Note:** for other special patterns or loadings, please check drawings, all other configurations on request only

## Header, 4 row, power, right angle, pin-in-paste, wide body

### FEATURES

- In accordance with IEC 60917 and IEC 61076-4-104 (Futurebus+)
- 4 x 2 power blades contacts
- 12 mm power modules are form- and fit interchangeable with signal modules on same footprint

### TECHNICAL DATA

#### PHYSICAL

- spacing: 2,00 mm x 2,00 mm
- housing: glass-filled LCP (30% glass), colour natural
- flammability rating: UL 94 V-0
- contact material: phosphor bronze
- performance level: Telcordia CO

#### ELECTRICAL

- current rating: 3 A
- insulation resistance:  $5 \times 10^3 \text{ M}\Omega$  initially,  $1 \times 10^3 \text{ M}\Omega$  after tests
- withstanding voltage: 1000 V rms (sea level)

#### MECHANICAL PERFORMANCE

- insertion force: 1,50 N max. per individual power contact (mating)
- withdrawal force: 0,30 N max. per individual power contact (unmating)
- recommended hole diameter: 0,65-0,80 mm

#### ENVIRONMENTAL

- Operating temperature  $-55^\circ\text{C}$  to  $+125^\circ\text{C}$
- RoHs information, this product is compatible according to the European Union Directive 2002/95/IEC

#### PACKAGING

- Trays

#### PROCESSING INFORMATION

- Pick&place by vacuum nozzle or mechanical gripper
- automatic Surface-mount reflow process, resistance for Lead Free reflow temperature

#### REFERENCE DATA

- Product specification: GS-12-446
- Application Specification BUS-20-075

#### APPLICATION EQUIPMENT

- for application equipment, check out the application equipment table on page 217-223



### MATING DATA

- Receptacle, straight, solder-to-board, page 123
- part number 85968-101LF

### TYPICAL APPLICATIONS

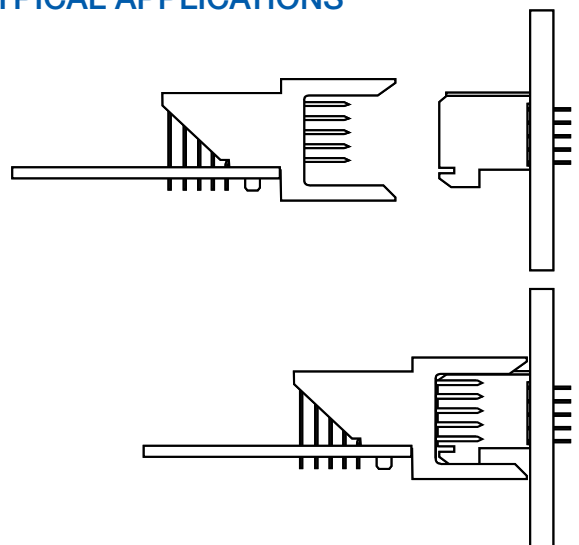

# Header, 4 row, power, right angle, pin-in-paste, wide body

## PRODUCT

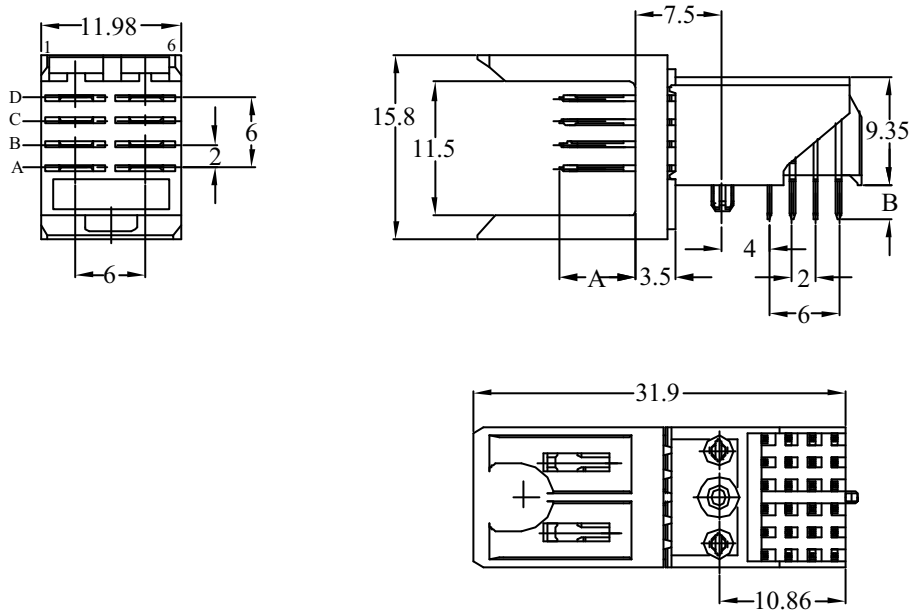

PCB pattern P1, see chapter PCB layouts

## PARTNUMBERS

HM1K4 1 DFP000H6PLF

Base Part Number	Type	no. of rows	no. of pos.	Configuration	000	Performance	Packaging	LF						
HM1	K = power header right angle	4 = 4 row	1 = 1 module (4 x 2 pos.)	DFP = Pin-in-Paste		H6 = Telcordia CO	P = trays	LF = lead free						
				<table border="1"> <thead> <tr> <th>mating length (A)</th> <th>tail length (B)</th> </tr> </thead> <tbody> <tr> <td>6,50 mm</td> <td>2,90 mm</td> </tr> <tr> <td colspan="2">1,6 mm PCB thickness</td> </tr> </tbody> </table>	mating length (A)	tail length (B)	6,50 mm	2,90 mm	1,6 mm PCB thickness					
mating length (A)	tail length (B)													
6,50 mm	2,90 mm													
1,6 mm PCB thickness														

**Note:** for other special patterns or loadings, please check drawings, all other configurations on request only

## Receptacle, 4 row, power, straight, solder to board

### FEATURES

- In accordance with IEC 60917 and IEC 61076-4-104 (Futurebus+)
- 4 x 2 dual beam power blades contacts
- 12 mm power modules are form- and fit interchangeable with signal modules on same footprint
- Modular design guarantees flexibility
- Stackable end-to-end without loss of position
- Stackable with other METRAL® function modules (power, I/O)

### TECHNICAL DATA

#### PHYSICAL

- spacing: 2,00 mm x 2,00 mm
- housing: glass-filled LCP (30% glass), colour natural
- flammability rating: UL 94 V-0
- contact material: phosphor bronze
- performance level: Telcordia CO

#### ELECTRICAL

- current rating: 3 A
- insulation resistance:  $5 \times 10^3 \text{ M}\Omega$  initially,  $1 \times 10^3 \text{ M}\Omega$  after tests
- withstanding voltage: 1000 V rms (sea level)

#### MECHANICAL PERFORMANCE

- insertion force: 1,50 N max. per individual power contact (mating)
- withdrawal force: 0,30 N max. per individual power contact (unmating)
- recommended hole diameter: 0,65-0,80 mm

#### ENVIRONMENTAL

- Operating temperature  $-55^\circ\text{C}$  to  $+125^\circ\text{C}$
- RoHs information, this product is compatible according to the European Union Directive 2002/95/IEC

#### PACKAGING

- Trays

#### PROCESSING INFORMATION

- Applicable process: wave, IR, vapor phase

#### REFERENCE DATA

- Product Specification GS-12-453

#### APPLICATION EQUIPMENT

- for application equipment, check out the application equipment table on page 217-223

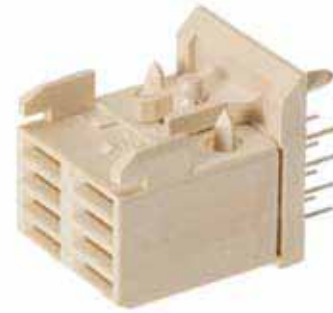

### MATING DATA

- Header, right angle, press-fit, page 119
  - part number HM1K41DDP000H6PLF
- Header, right angle, solder-to-board, page 117
  - part number HM1K41DAP000H6PLF
- Header, right angle, Pin-in-Paste, page 121
  - part number HM1K41DFP000H6PLF

### TYPICAL APPLICATIONS

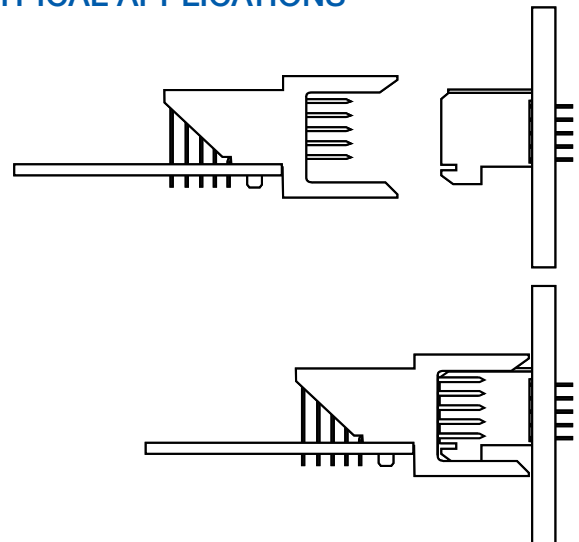



# Receptacle, 4 row, power, straight, solder to board

## PRODUCT

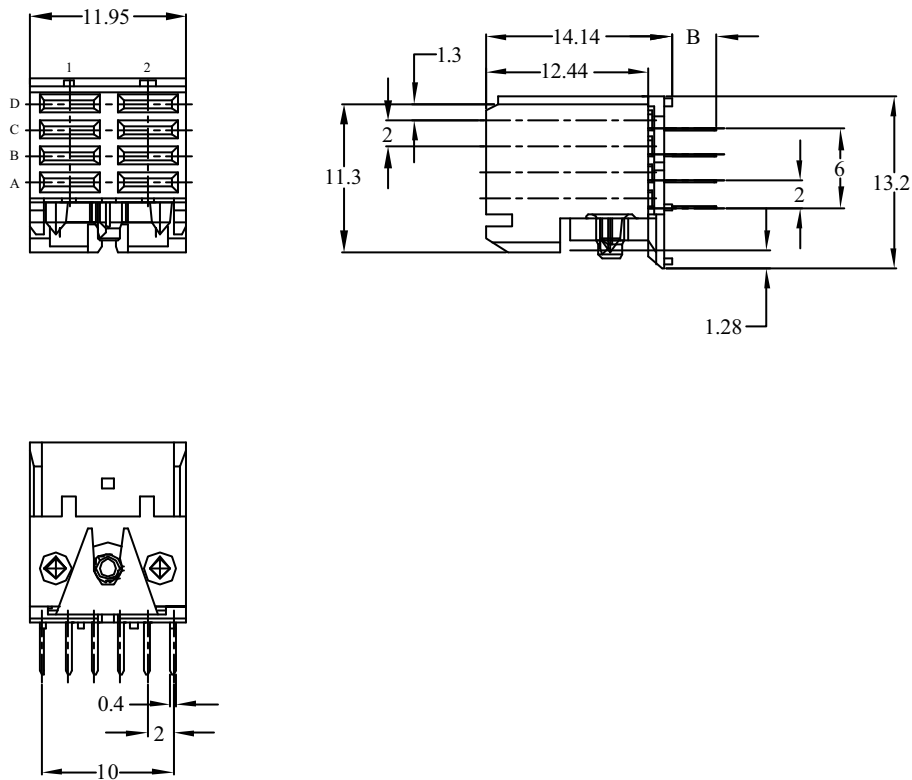

PCB pattern P5, see chapter PCB layouts

## PARTNUMBERS

85968 - 101LF

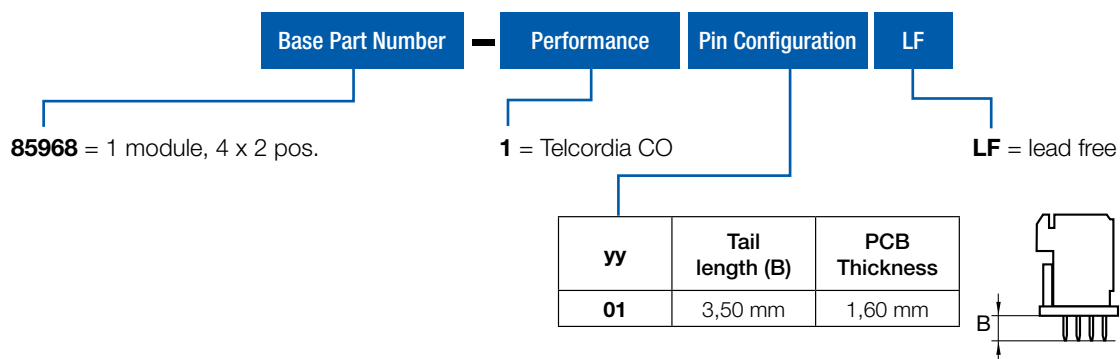

**Note:** for other special patterns or loadings, please check drawings, all other configurations on request only

## Header, 5 row, power, right angle, solder to board, wide body

### FEATURES

- In accordance with IEC 60917 and IEC 61076-4-104 (Futurebus+)
- 5 x 2 power blades contacts
- 12 mm power modules are form- and fit interchangeable with signal modules on same footprint

### TECHNICAL DATA

#### PHYSICAL

- spacing: 2,00 mm x 2,00 mm
- housing: glass-filled LCP (30% glass), colour natural
- flammability rating: UL 94 V-0
- contact material: phosphor bronze
- performance level: Telcordia CO

#### ELECTRICAL

- current rating: 3 A
- insulation resistance: 5x10<sup>3</sup> MΩ initially, 1x10<sup>3</sup> MΩ after tests
- withstanding voltage: 1000 V rms (sea level)

#### MECHANICAL PERFORMANCE

- insertion force: 1,50 N max. per individual power contact (mating)
- withdrawal force: 0,30 N max. per individual power contact (unmating)
- recommended hole diameter: 0,65-0,80 mm

#### ENVIRONMENTAL

- Operating temperature -55°C to + 125°C
- RoHs information, this product is compatible according to the European Union Directive 2002/95/IEC

#### PACKAGING

- Trays

#### PROCESSING INFORMATION

- Applicable process: wave, IR, vapor phase

#### REFERENCE DATA

- Product specification: GS-12-446
- Application Specification BUS-20-075

#### APPLICATION EQUIPMENT

- for application equipment, check out the application equipment table on page 217-223



### MATING DATA

- Receptacle, straight, solder-to-board, page 131
- part number 94561-112LF

### TYPICAL APPLICATIONS

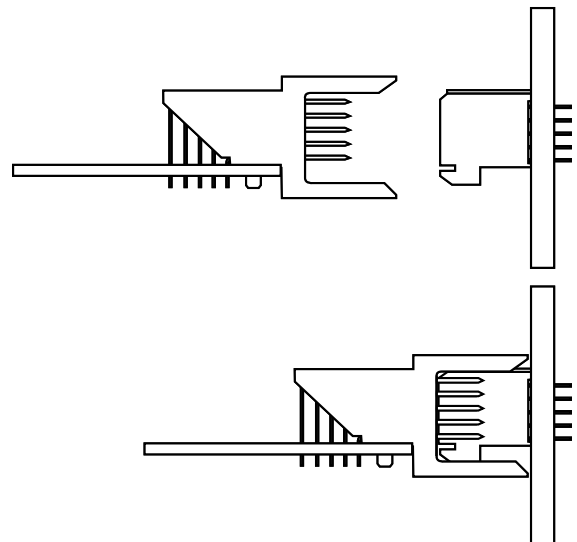

# Header, 5 row, power, right angle, solder to board, wide body

## PRODUCT

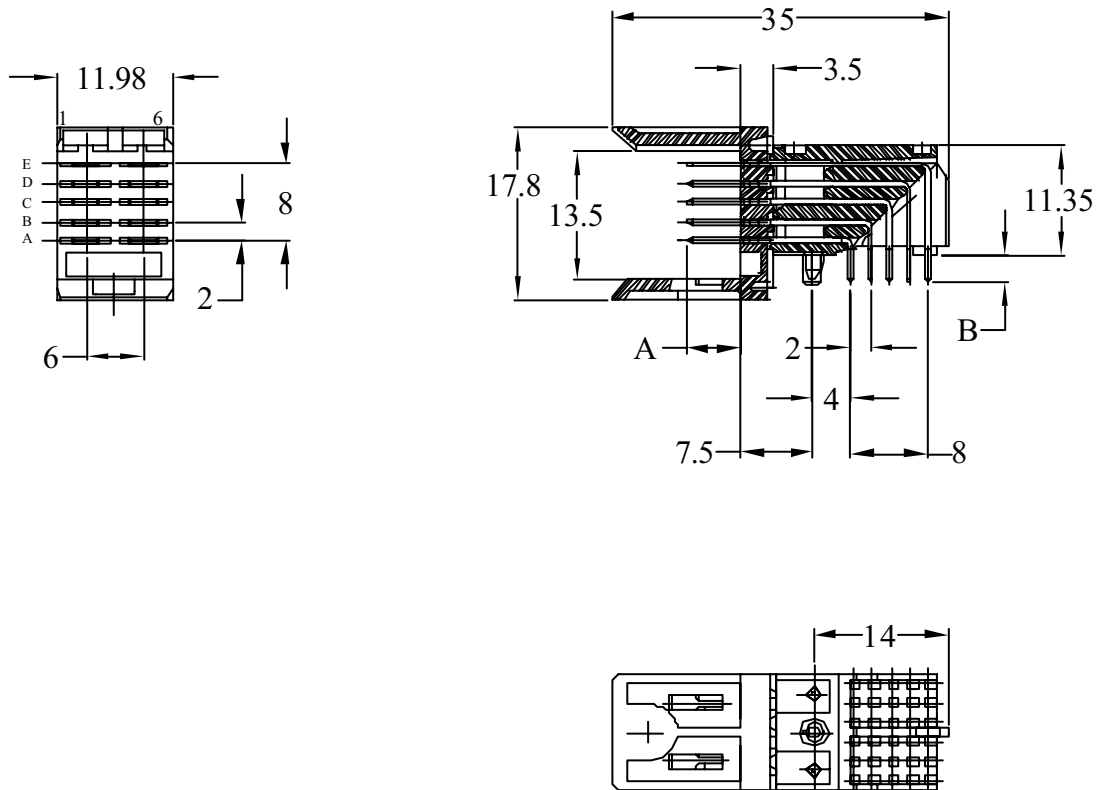

PCB pattern P2, see chapter PCB layouts

POWER CONNECTORS

## PARTNUMBERS

**HM1K5 1 DAP000H6PLF**

Base Part Number	Type	no. of rows	no. of pos.	Configuration	000	Performance	Packaging	LF						
<b>HM1</b>	<b>K</b> = power header right angle	<b>5</b> = 5 row	<b>1</b> = 1 module (5 x 2 pos.)	<b>DAP</b> = solder to board <table border="1"> <thead> <tr> <th>mating length (A)</th> <th>tail length (B)</th> </tr> </thead> <tbody> <tr> <td>6,50 mm</td> <td>2,90 mm</td> </tr> <tr> <td colspan="2">1,6 mm PCB thickness</td> </tr> </tbody> </table>	mating length (A)	tail length (B)	6,50 mm	2,90 mm	1,6 mm PCB thickness			<b>H6</b> = Telcordia CO	<b>P</b> = trays	<b>LF</b> = lead free
mating length (A)	tail length (B)													
6,50 mm	2,90 mm													
1,6 mm PCB thickness														

**Note:** for other special patterns or loadings, please check drawings, all other configurations on request only

## Header, 5 row, power, right angle, press-fit, wide body

### FEATURES

- In accordance with IEC 60917 and IEC 61076-4-104 (Futurebus+)
- 5 x 2 power blades contacts
- 12 mm power modules are form- and fit interchangeable with signal modules on same footprint
- Eye the needle press-fit contac

### TECHNICAL DATA

#### PHYSICAL

- spacing: 2,00 mm x 2,00 mm
- housing: glass-filled LCP (30% glass), colour natural
- flammability rating: UL 94 V-0
- contact material: phosphor bronze
- performance level: Telcordia CO

#### ELECTRICAL

- current rating: 3 A
- insulation resistance:  $5 \times 10^3 \text{ M}\Omega$  initially,  $1 \times 10^3 \text{ M}\Omega$  after tests
- withstanding voltage: 1000 V rms (sea level)

#### MECHANICAL PERFORMANCE

- insertion force: 1,50 N max. per individual power contact (mating)
- withdrawal force: 0,30 N max. per individual power contact (unmating)
- press-fit contact insertion: 55 N max. per pin
- press-fit pin withdrawal: 15 N min. per pin
- recommended hole diameter: 0,65-0,80 mm

#### ENVIRONMENTAL

- Operating temperature -55°C to + 125°C
- RoHs information, this product is compatible according to the European Union Directive 2002/95/IEC

#### PACKAGING

- Trays

#### PROCESSING INFORMATION

- Applicable process: press fit

#### REFERENCE DATA

- Product specification: GS-12-445
- Application Specification BUS-20-075

#### APPLICATION EQUIPMENT

- for application equipment, check out the application equipment table on page 217-223

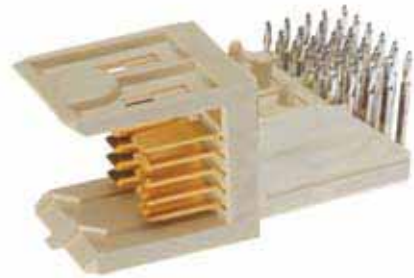

### MATING DATA

- Receptacle, straight, solder-to-board, page 131
- part number 94561-112LF

### TYPICAL APPLICATIONS

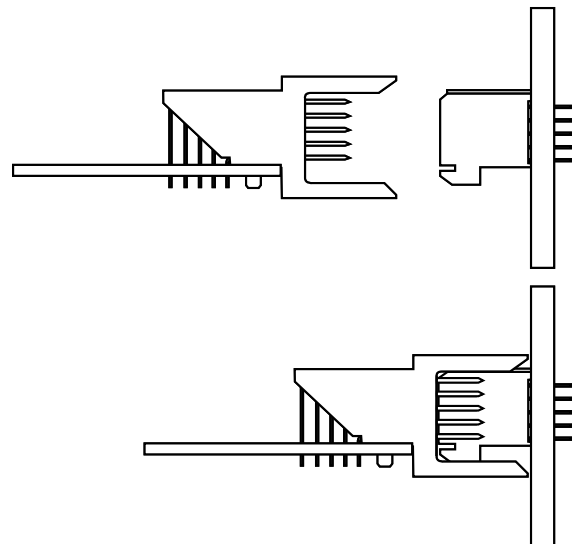

# Header, 5 row, power, right angle, press-fit, wide body

## PRODUCT

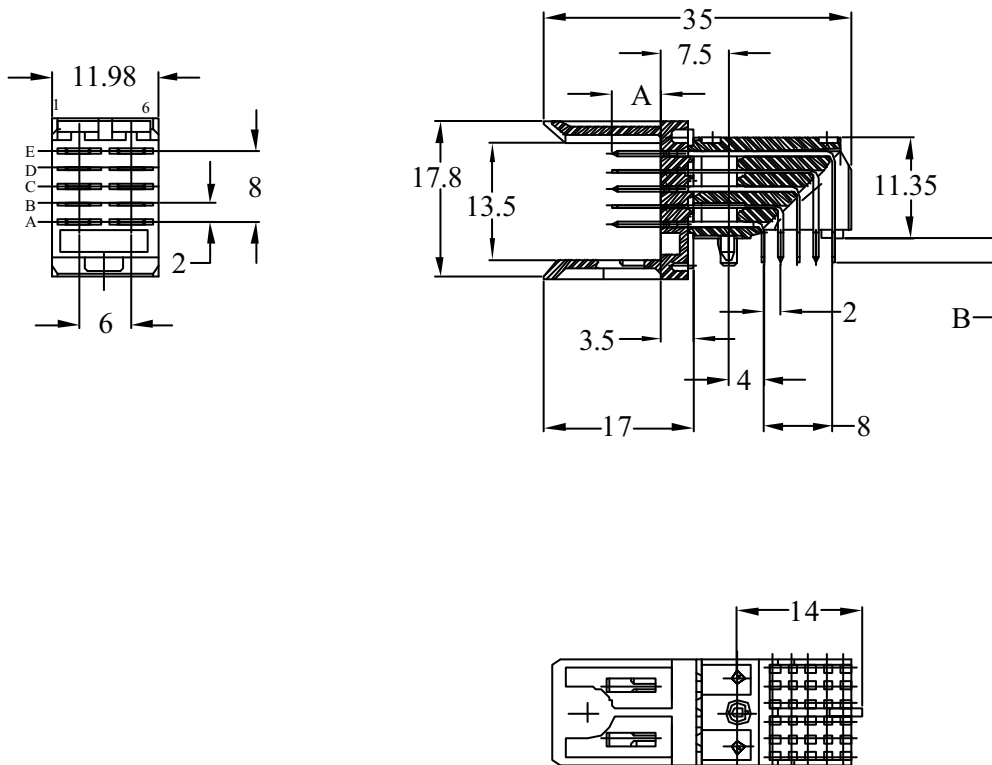

PCB pattern P2, see chapter PCB layouts

## PARTNUMBERS

HM1K5 1 DDP000H6PLF

Base Part Number	Type	no. of rows	no. of pos.	Configuration	000	Performance	Packaging	LF
------------------	------	-------------	-------------	---------------	-----	-------------	-----------	----

HM1

K = power header right angle

5 = 5 row

DDP = press fit

mating length (A)	tail length (B)
6,50 mm	2,90 mm
1,6 mm PCB thickness	

H6 = Telcordia CO

LF = lead free

P = trays

1 = 1 module (5 x 2 pos.)

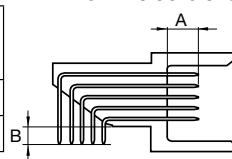

**Note:** for other special patterns or loadings, please check drawings, all other configurations on request only

## Header, 5 row, power, right angle, pin-in-paste, wide body

### FEATURES

- In accordance with IEC 60917 and IEC 61076-4-104 (Futurebus+)
- 5 x 2 power blades contacts
- 12 mm power modules are form- and fit interchangeable with signal modules on same footprint

### TECHNICAL DATA

#### PHYSICAL

- spacing: 2,00 mm x 2,00 mm
- housing: glass-filled LCP (30% glass), colour natural
- flammability rating: UL 94 V-0
- contact material: phosphor bronze
- performance level: Telcordia CO

#### ELECTRICAL

- current rating: 3 A
- insulation resistance:  $5 \times 10^3 \text{ M}\Omega$  initially,  $1 \times 10^3 \text{ M}\Omega$  after tests
- withstanding voltage: 1000 V rms (sea level)

#### MECHANICAL PERFORMANCE

- insertion force: 1,50 N max. per individual power contact (mating)
- withdrawal force: 0,30 N max. per individual power contact (unmating)
- recommended hole diameter: 0,65-0,80 mm

#### ENVIRONMENTAL

- Operating temperature -55°C to + 125°C
- RoHs information, this product is compatible according to the European Union Directive 2002/95/IEC

#### PACKAGING

- Trays

#### PROCESSING INFORMATION

- Pick&place by vacuum nozzle or mechanical gripper
- automatic Surface-mount reflow process, resistance for Lead Free reflow temperature

#### REFERENCE DATA

- Product specification: GS-12-446
- Application Specification BUS-20-075

#### APPLICATION EQUIPMENT

- for application equipment, check out the application equipment table on page 217-223



### MATING DATA

- Receptacle, straight, solder-to-board, page 131
- part number 94561-112LF

### TYPICAL APPLICATIONS

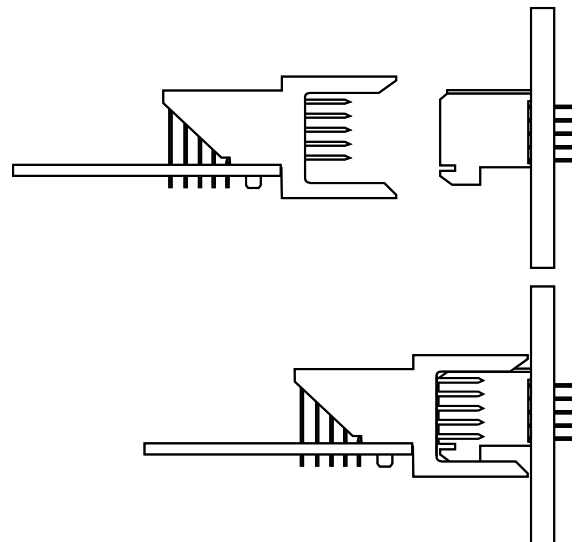

# Header, 5 row, power, right angle, pin-in-paste, wide body

## PRODUCT

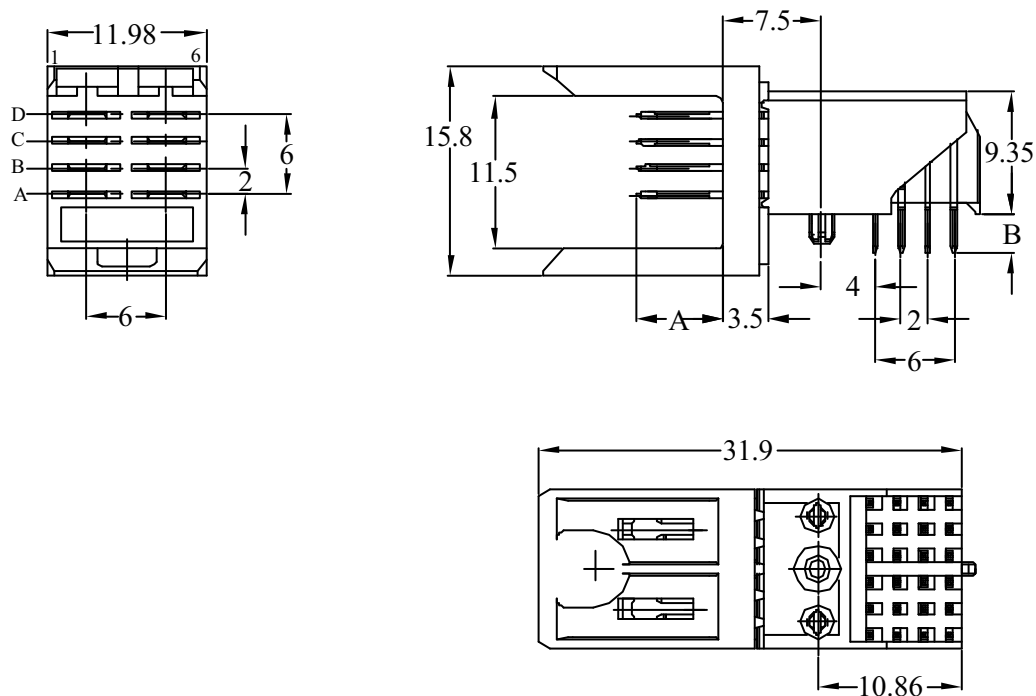

PCB pattern P2, see chapter PCB layouts

POWER CONNECTORS

## PARTNUMBERS

**HM1K5 1 DFP000H6PLF**

Base Part Number	Type	no. of rows	no. of pos.	Configuration	000	Performance	Packaging	LF						
<b>HM1</b>	<b>K</b> = power header right angle	<b>5</b> = 5 row	<b>1</b> = 1 module (5 x 2 pos.)	<b>DFP</b> = Pin-in-Paste <table border="1"> <thead> <tr> <th>mating length (A)</th> <th>tail length (B)</th> </tr> </thead> <tbody> <tr> <td>6,50 mm</td> <td>2,90 mm</td> </tr> <tr> <td colspan="2">1,6 mm PCB thickness</td> </tr> </tbody> </table>	mating length (A)	tail length (B)	6,50 mm	2,90 mm	1,6 mm PCB thickness			<b>H6</b> = Telcordia CO	<b>P</b> = trays	<b>LF</b> = lead free
mating length (A)	tail length (B)													
6,50 mm	2,90 mm													
1,6 mm PCB thickness														

**Note:** for other special patterns or loadings, please check drawings, all other configurations on request only

## Receptacle, 5 row, power, straight, solder to board

### FEATURES

- In accordance with IEC 60917 and IEC 61076-4-104 (Futurebus+)
- 5 x 2 dual beam power blades contacts
- 12 mm power modules are form- and fit interchangeable with signal modules on same footprint
- Modular design guarantees flexibility
- Stackable end-to-end without loss of position
- Stackable with other METRAL® function modules (power, I/O)

### TECHNICAL DATA

#### PHYSICAL

- spacing: 2,00 mm x 2,00 mm
- housing: glass-filled LCP (30% glass), colour natural
- flammability rating: UL 94 V-0
- contact material: phosphor bronze
- performance level: Telcordia CO

#### ELECTRICAL

- current rating: 3 A
- insulation resistance: 5x10<sup>3</sup> MΩ initially, 1x10<sup>3</sup> MΩ after tests
- withstanding voltage: 1000 V rms (sea level)

#### MECHANICAL PERFORMANCE

- insertion force: 1,50 N max. per individual power contact (mating)
- withdrawal force: 0,30 N max. per individual power contact (unmating)
- recommended hole diameter: 0,65-0,80 mm

#### ENVIRONMENTAL

- Operating temperature -55°C to + 125°C
- RoHs information, this product is compatible according to the European Union Directive 2002/95/IEC

#### PACKAGING

- Standard Tubes

#### PROCESSING INFORMATION

- Applicable process: wave, IR, vapor phase

#### REFERENCE DATA

- Product Specification GS-12-453

#### APPLICATION EQUIPMENT

- for application equipment, check out the application equipment table on page 217-223

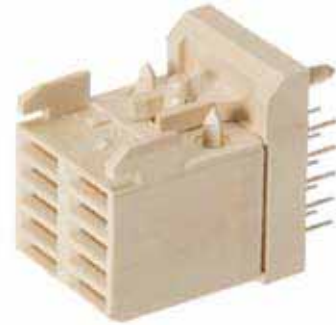

### MATING DATA

- Header, right angle, press-fit, page 127
  - part number HM1K451DDP000H6PLF
- Header, right angle, solder-to-board, page 125
  - part number HM1K51DAP000H6PLF
- Header, right angle, Pin-in-Paste, page 129
  - part number HM1K51DFP000H6PLF

### TYPICAL APPLICATIONS

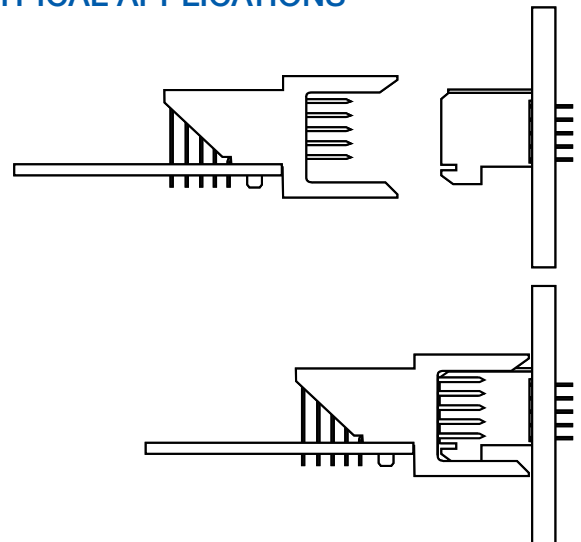



# Receptacle, 5 row, power, straight, solder to board

## PRODUCT

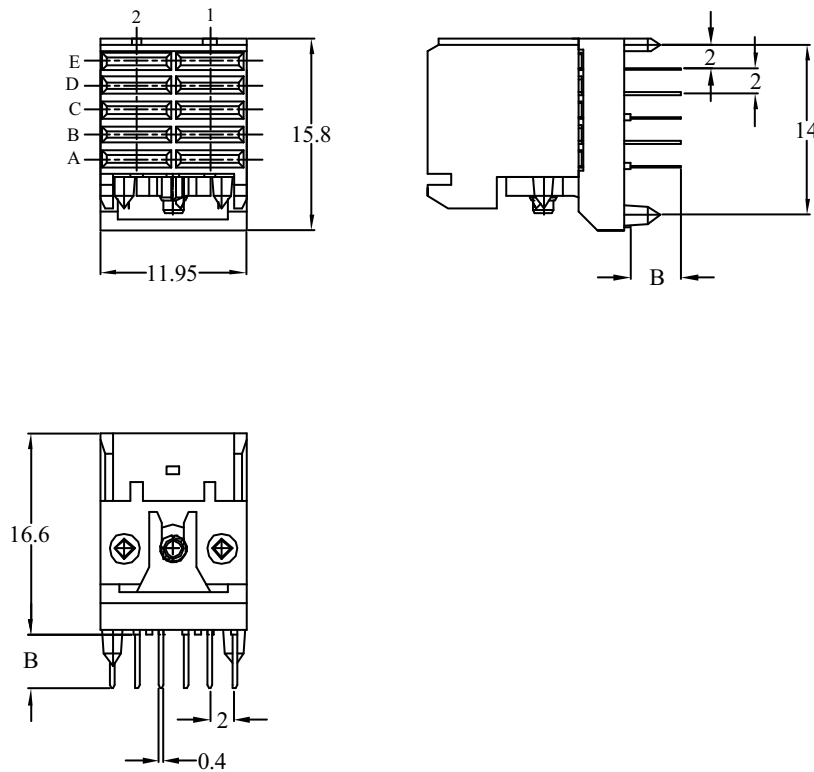

PCB pattern P16, see chapter PCB layouts

POWER CONNECTORS

## PARTNUMBERS

94561 - 1yyLF

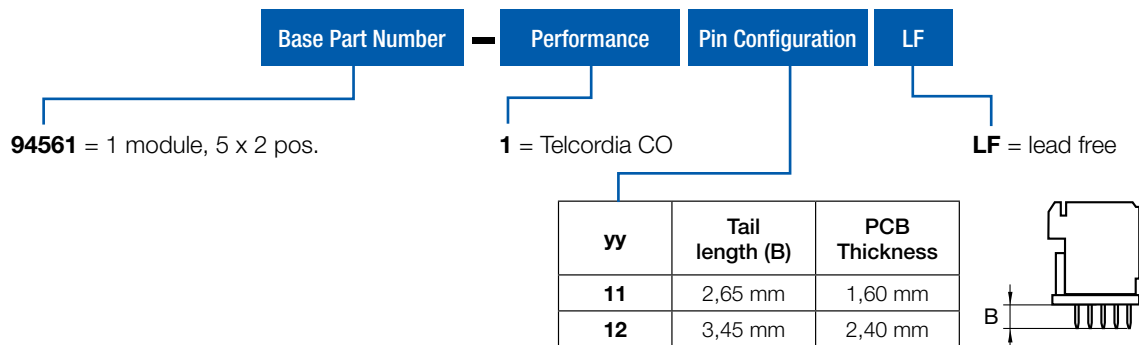



**Note:** for other special patterns or loadings, please check drawings, all other configurations on request only

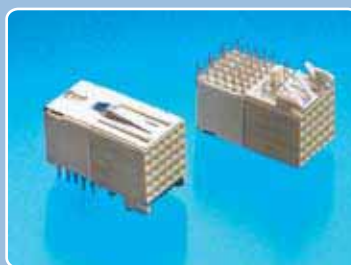



## METRAL® ELECTRICAL ENHANCED SIGNAL CONNECTORS

-  Header, Straight, 5 row
-  Shroud, 5 row
-  Receptacle, Right Angle, 5 row

## Header, 5+2 row, signal, straight, press-fit, wide body

### FEATURES

- ▶ 5 row Header
- ▶ 2 row Shielding, because of die-cast housing all signal pins are surrounded by a ground path, consequently reducing crosstalk and ground bounce.
- ▶ EMI of 15 dB
- ▶ Press-fit, eye of the needle contact



### TECHNICAL DATA

#### PHYSICAL

- ▶ Housing: Die-cast zinc alloy
- ▶ Wafer material: glass filled LCP, UL 94 V-0, color natural
- ▶ Contact material: Phosphor bronze
- ▶ Performance level: Telcordia CO

#### ELECTRICAL

- ▶ current rating: 1 A
- ▶ withstanding voltage: 1000 V rms (sea level)

#### MECHANICAL PERFORMANCE

- ▶ insertion force: 0,45 N max. per individual signal contact (mating)
- ▶ withdrawal force: 0,15 N max. per individual signal contact (unmating)
- ▶ press-fit contact insertion: 65 N max. per pin
- ▶ press-fit pin withdrawal: 20 N min. per pin
- ▶ recommended hole diameter: 0,65-0,80 mm

#### ENVIRONMENTAL

- ▶ Operating temperature range: -55°C to +125°C
- ▶ RoHs information, this product is compatible according to the European Union Directive 2002/95/IEC

#### PACKAGING

- ▶ standard: tubes

#### PROCESSING INFORMATION

- ▶ press fit

#### REFERENCE DATA

- ▶ Product specification GS-12-074
- ▶ Application specification TA-941

#### APPLICATION EQUIPMENT

- ▶ for application equipment, check out the application equipment table on page 217-223

### MATING DATA

#### Electrical Enhanced Receptacle, Signal, right angle

- ▶ part number 85847-102LF, page 139

#### Electrical Enhanced Shroud, wide body

- ▶ part numbers 70438-111LF, page 137

### TYPICAL APPLICATIONS

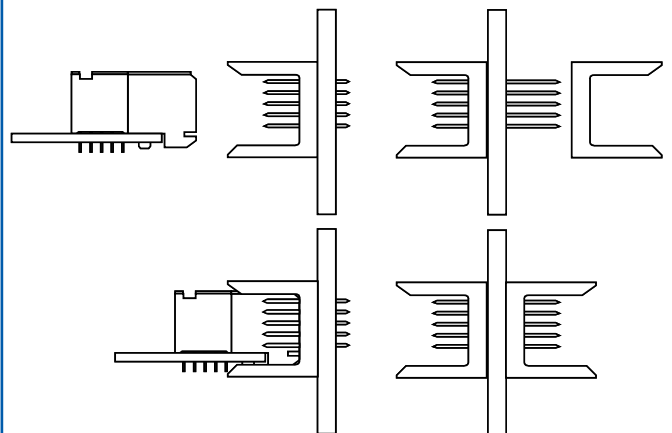

# Header, 5+2 row, signal, straight, press-fit, wide body

## PRODUCT

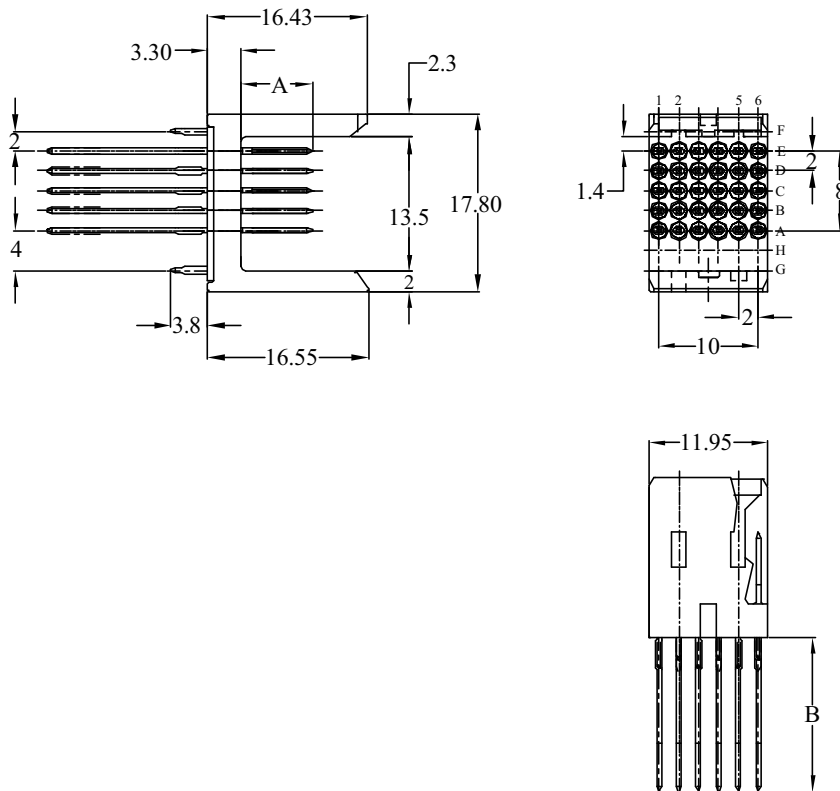

PCB pattern P15, see chapter PCB layouts

ELECTRICAL ENHANCED

## PARTNUMBERS

70437 - 1yyLF

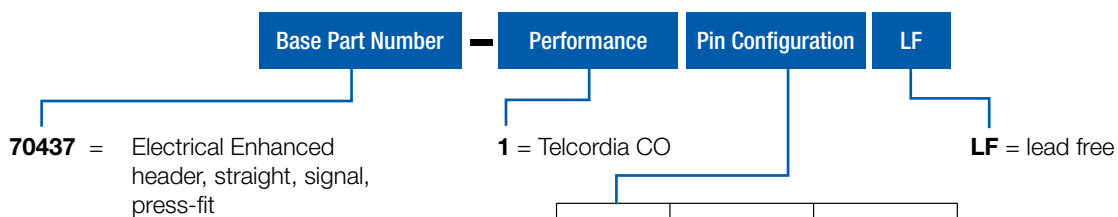

yy	mating length (A)	rear plug up length (B)
11	6,50 mm	4,30 mm
16	5,75 mm	4,30 mm
18	5,00 mm	4,30 mm
21	6,50 mm	13,60 mm
26	5,75 mm	13,60 mm
28	5,00 mm	13,60 mm

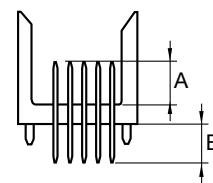

**Note:** for other special patterns or loadings, please check drawings, all other configurations on request only

## Shroud, 5+2 row, wide body

### FEATURES

- 5 row Shroud
- 2 row Shielding, because of die-cast housing all signal pins are surrounded by a ground path, consequently reducing crosstalk and ground bounce.
- EMI of 15 dB



### TECHNICAL DATA

#### PHYSICAL

- Housing: Die-cast zinc alloy
- Wafer material: glass filled LCP, UL 94 V-0, color natural

#### ELECTRICAL

- current rating: 1 A
- withstanding voltage: 1000 V rms (sea level)

#### MECHANICAL PERFORMANCE

- insertion force: 0,45 N max. per individual signal contact (mating)
- withdrawal force: 0,15 N max. per individual signal contact (unmating)

#### ENVIRONMENTAL

- Operating temperature range: -55°C to +125°C
- RoHs information, this product is compatible according to the European Union Directive 2002/95/IEC

#### PACKAGING

- standard: tubes

#### PROCESSING INFORMATION

- press fit

#### REFERENCE DATA

- Product specification GS-12-074

#### APPLICATION EQUIPMENT

- for application equipment, check out the application equipment table on page 217-223

### MATING DATA

- Rear plug up- Header, Signal, straight, press-fit, page 135
- partnumber 70437-121LF
- partnumber 70437-126LF
- partnumber 70437-128LF

### TYPICAL APPLICATIONS

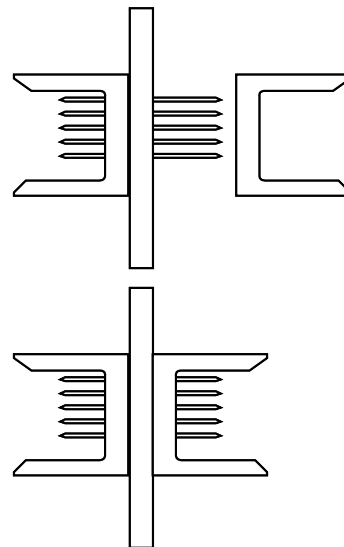

# Shroud, 5+2 row, wide body

## PRODUCT

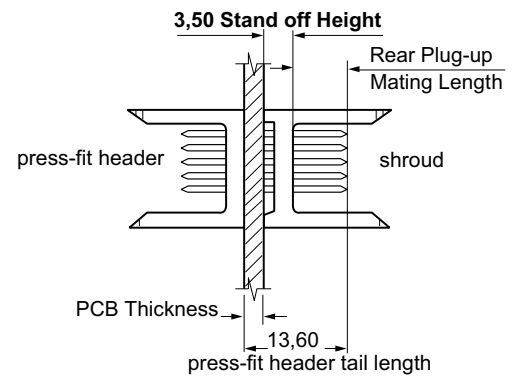
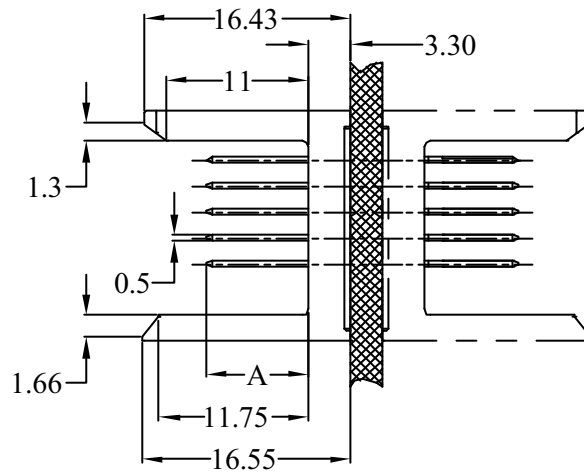
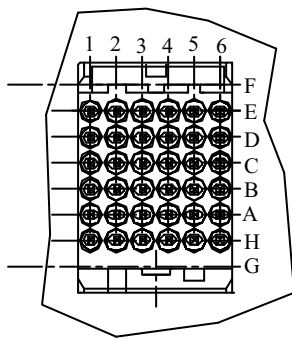

ELECTRICAL ENHANCED

## PARTNUMBERS

**70438 - 111LF**

**Base Part Number** - **no.of positions** **LF**

**70438** = Electrical Enhanced Shroud, wide body

**111** = 1 module, 5 x 6 positions

**LF** = lead free

## Receptacle, 5+2 row, signal, right angle, press fit

### FEATURES

- 5 row Receptacle
- 2 row Shielding, because of die-cast housing all signal pins are surrounded by a ground path, consequently reducing crosstalk and ground bounce.
- EMI of 15 dB
- Press-fit, eye of the needle contact

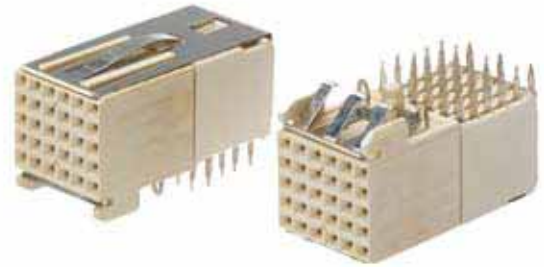

### TECHNICAL DATA

#### PHYSICAL

- Housing: glass-filled LCP, colour natural
- flammability rating: UL 94 V-0
- Contact material: Phosphor bronze
- Shielding material: Phosphor bronze
- Performance level: Telcordia CO

#### ELECTRICAL

- current rating: 1 A
- withstanding voltage: 1000 V rms (sea level)

#### MECHANICAL PERFORMANCE

- insertion force: 0,45 N max. per individual signal contact (mating)
- withdrawal force: 0,15 N max. per individual signal contact (unmating)
- press-fit contact insertion: 65 N max. per pin
- press-fit pin withdrawal: 20 N min. per pin
- recommended hole diameter: 0,65-0,80 mm

#### ENVIRONMENTAL

- Operating temperature range: -55°C to +125°C
- RoHs information, this product is compatible according to the European Union Directive 2002/95/IEC

#### PACKAGING

- standard: tubes

#### PROCESSING INFORMATION

- press fit

#### REFERENCE DATA

- Product specification GS-12-074
- Application specification TA-941

#### APPLICATION EQUIPMENT

- for application equipment, check out the application equipment table on page 217-223

### MATING DATA

- Electrical Enhanced Header, Signal, straight, page 135

- part number 70437-111LF
- part number 70437-116LF
- part number 70437-118LF

### TYPICAL APPLICATIONS

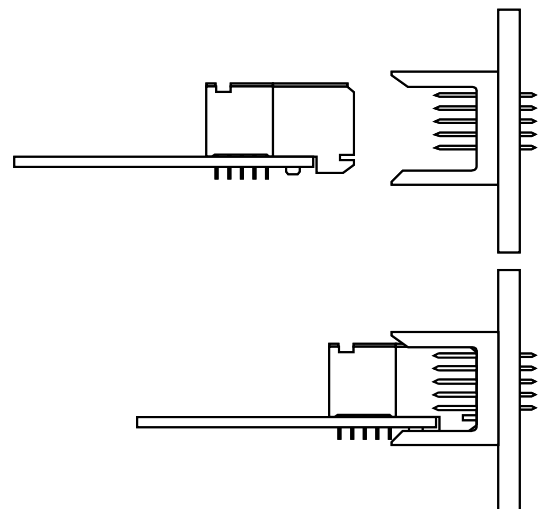



# Receptacle, 5+2 row, signal, right angle, press fit

## PRODUCT

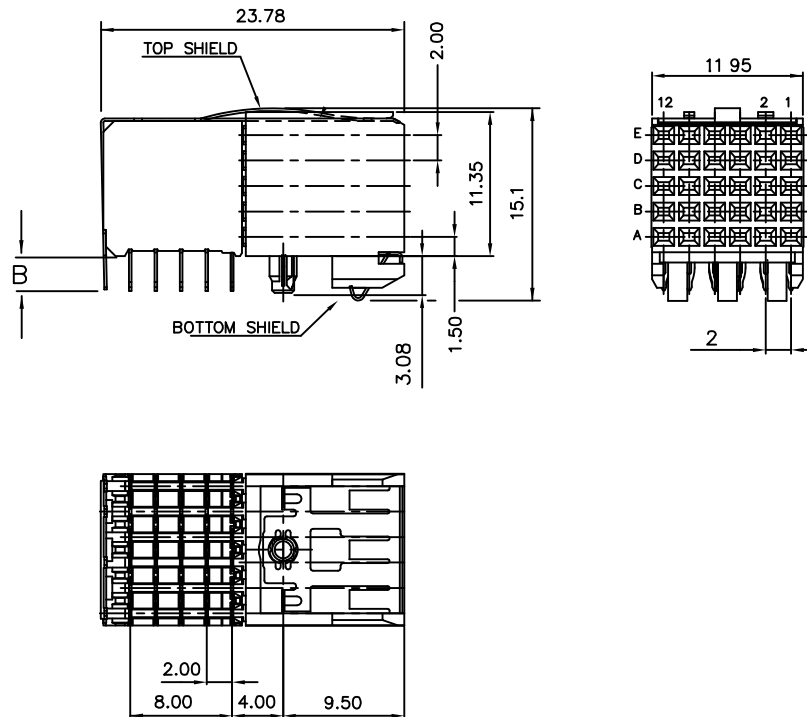

PCB pattern P2, see chapter PCB layouts

## PARTNUMBERS

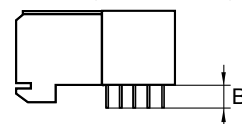
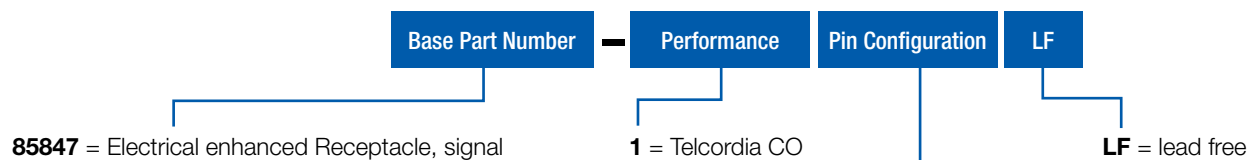

85847 - 102LF







## METRAL® SHIELDED SIGNAL CONNECTORS

-  Header, Straight, 5 row
-  Round cable connector

## Shielded Header, 5 row, signal, straight, press-fit

### FEATURES

- ▶ Because of die-cast housing all signal pins are surrounded by a ground path.
- ▶ EMI improved
- ▶ 5 row Header, 1 module
- ▶ active latching system
- ▶ Press-fit, eye of the needle contact



### TECHNICAL DATA

#### PHYSICAL

- ▶ Housing: Die-cast zinc alloy
- ▶ Wafer material: glass filled LCP, UL 94 V-0, color natural
- ▶ Contact material: Phosphor bronze
- ▶ Ground spring material : copper-nickel-tin alloy
- ▶ Performance level: Telcordia CO

#### ELECTRICAL

- ▶ current rating: 1 A
- ▶ withstanding voltage: 1000 V rms (sea level)

#### MECHANICAL PERFORMANCE

- ▶ insertion force: 0,45 N max. per individual signal contact (mating)
- ▶ withdrawal force: 0,15 N max. per individual signal contact (unmating)
- ▶ press-fit contact insertion: 65 N max. per pin
- ▶ press-fit pin withdrawal: 20 N min. per pin
- ▶ recommended hole diameter: 0,65-0,80 mm

#### ENVIRONMENTAL

- ▶ Operating temperature range: -55°C to +125°C
- ▶ RoHs information, this product is compatible according to the European Union Directive 2002/95/IEC

#### PACKAGING

- ▶ standard: tubes

#### PROCESSING INFORMATION

- ▶ press fit

#### REFERENCE DATA

- ▶ Product specification GS-12-135

#### APPLICATION EQUIPMENT

- ▶ for application equipment, check out the application equipment table on page 217-223

### MATING DATA

- ▶ **Round Cable connector, Shielded**
  - ▶ 5 x 6 pos. part number 85706-xxxxLF, page 145
- ▶ **Cable Connector**
  - ▶ 5 row, part number 72478-1111LF, page 175
- ▶ **Receptacle, 5 row**
  - ▶ Right angle, press-fit, part number 89047-102LF, page 45
  - ▶ Straight, press-fit, part number 85761-1101LF, page 79

### TYPICAL APPLICATIONS

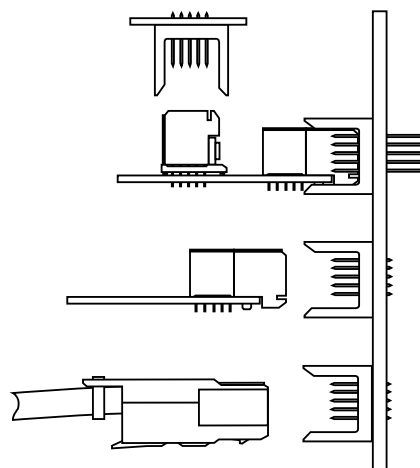

# Header, 5 row, signal, straight, press-fit

## PRODUCT

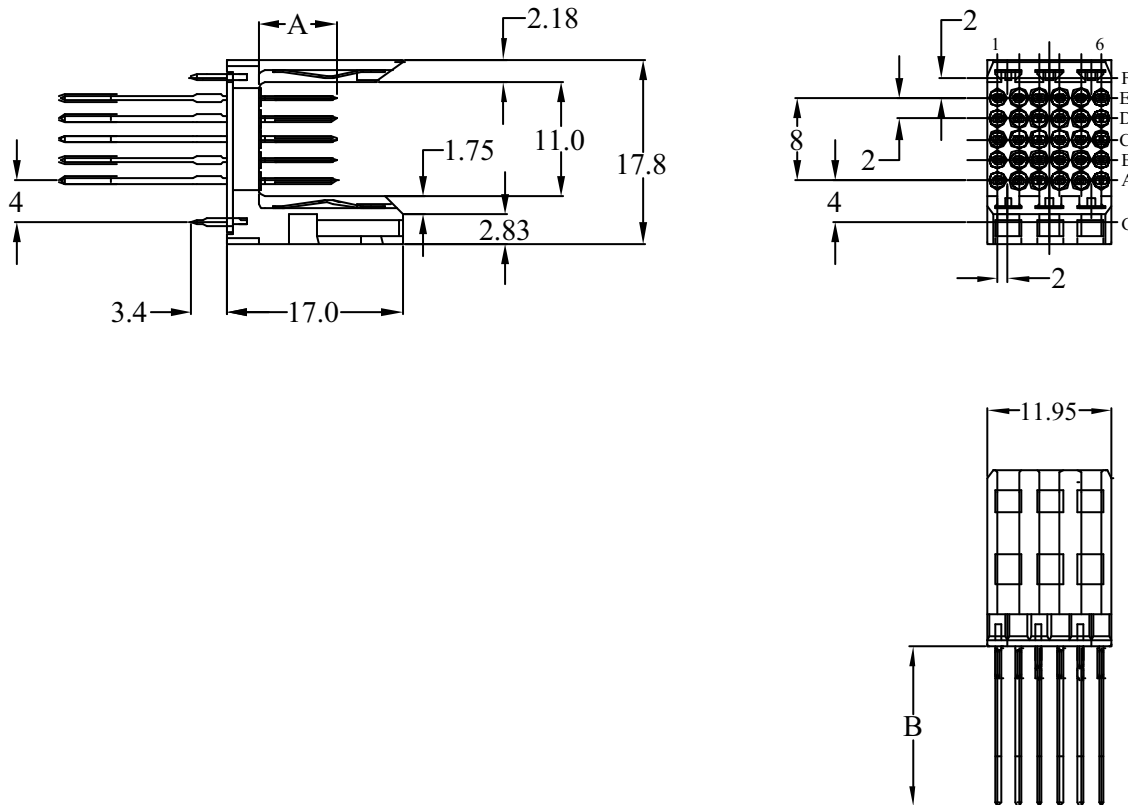

PCB pattern P15, see chapter PCB layouts

## PARTNUMBERS

72031 - 1yyLF

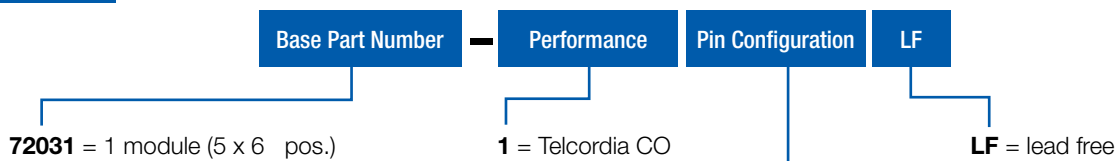

yy	mating length (A)	tail length (B)
11	6,50 mm	4,30 mm
16	5,75 mm	4,30 mm
first-make last-brake 14	row A = 5,75 mm	4,30 mm
	row B = 5,75 mm	4,30 mm
	row C = 7,25 mm	4,30 mm
	row D = 5,75 mm	4,30 mm
	row E = 5,75 mm	4,30 mm

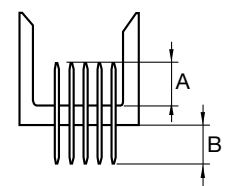

**Note:** for other special patterns or loadings, please check drawings, all other configurations on request only

## Shielded Cable Connector, 5 row, signal

### FEATURES

- ▶ 5 row , 1 module Round Cable Connector
- ▶ Heat Shrink or Crimp Ring version
- ▶ EMI improved
- ▶ Active latching system
- ▶ AWG size 24,26,28 and 30
- ▶ Reliable dual beam contact
- ▶ IDC wire termination

### TECHNICAL DATA

#### PHYSICAL

- ▶ Housing: glass filled thermoplastic polyester, color grey
- ▶ Latch: polycarbonate, color black, UL 94 V-0
- ▶ Cover: copper-nickel-tin alloy
- ▶ Contact material: Phosphor bronze
- ▶ Performance level: Telcordia CO

#### ELECTRICAL

- ▶ current rating: 1 A
- ▶ withstanding voltage: 1000 V rms (sea level)

#### MECHANICAL PERFORMANCE

- ▶ insertion force: 0,645 N max. per individual signal contact (mating)
- ▶ withdrawal force: 0,36 N max. per individual signal contact (unmating)

#### ENVIRONMENTAL

- ▶ Operating temperature range: -55°C to +125°C
- ▶ RoHs information, this product is compatible according to the European Union Directive 2002/95/IEC

#### PACKAGING

- ▶ Kits, bags of 100 pcs

#### REFERENCE DATA

- ▶ application specification GES-20-003

#### APPLICATION EQUIPMENT

- ▶ for application equipment, check out the application equipment table on page 217-223

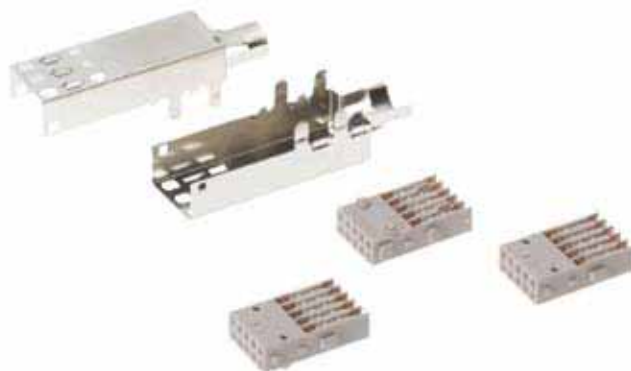

### MATING DATA

- ▶ Shielded Header, straight, press-fit, wide body, page 143
  - ▶ part number 72031-116LF
- ▶ Header, straight, press-fit, wide body, page 41
  - ▶ part number 89006-116LF
- ▶ Header, right angle, press-fit, wide body, page 73
  - ▶ part number HM151LDP000H6PLF

### TYPICAL APPLICATIONS

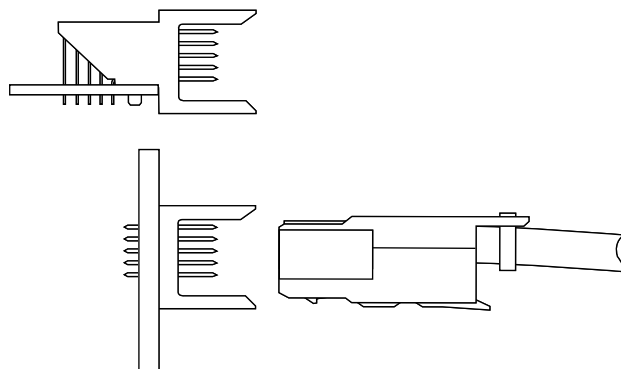

# Shielded Cable Connector, 5 row, signal

## PRODUCT

### Heat shrink version

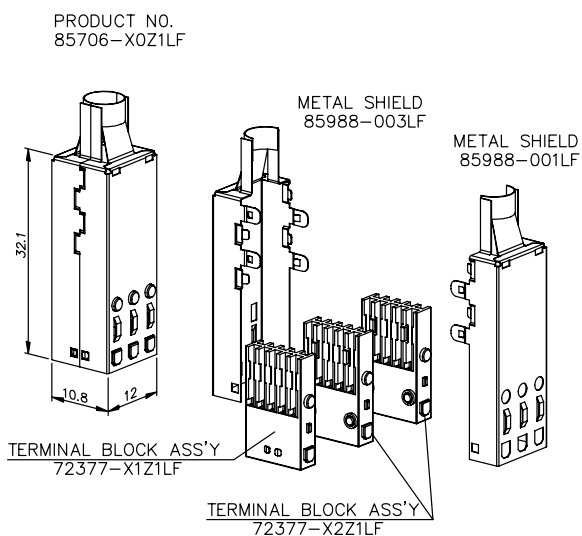

### Crimped version

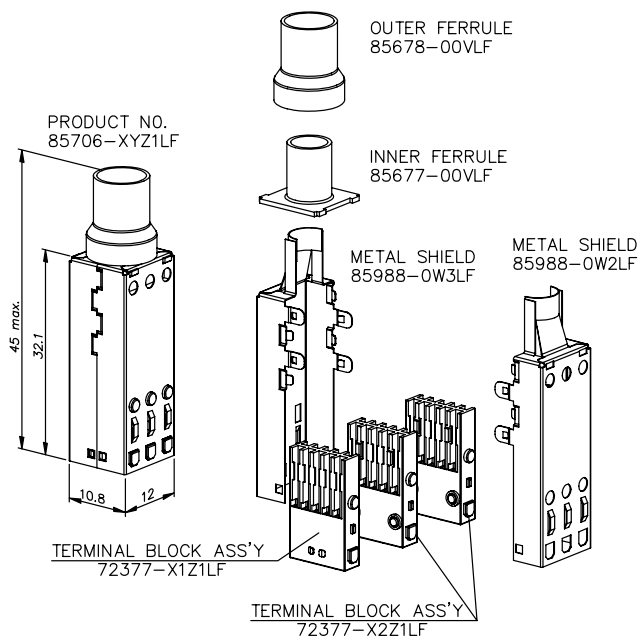

## PARTNUMBERS

**85706 - 1yz1LF**

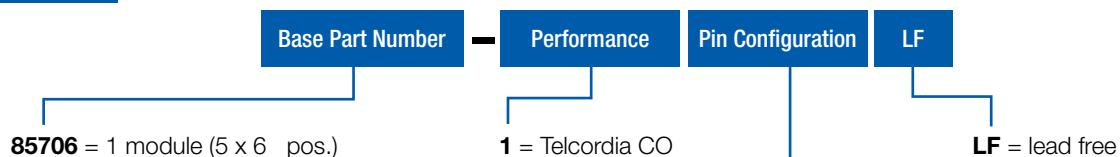



<b>yz1</b>	
<b>y = 0</b>	heat shrink version
<b>y = 2</b>	crimped version inner ferrule 8 mm dia. outer ferrule 10 mm dia.
<b>z = 1</b>	AWG size: 26 to 24 AWG
<b>z = 2</b>	AWG size: 30 to 28 AWG







## METRAL® HIGH POWER CONNECTORS

-  Header, High Power
-  Receptacle, High Power

## Header, High Power

### FEATURES

- Available in 1x2 or 2x2 contact configurations
- Rated for up to 80 Amps current for a single module
- Voltage Rating: 150V
- Receptacle connectors can be provided with two contact lengths to enable first-mate/last break sequencing
- Protected backplane receptacle connector is UL 60950 (Finger Probe) compliant
- Layout compatible with Metral 2mm backplane connector family
- Press-fit termination

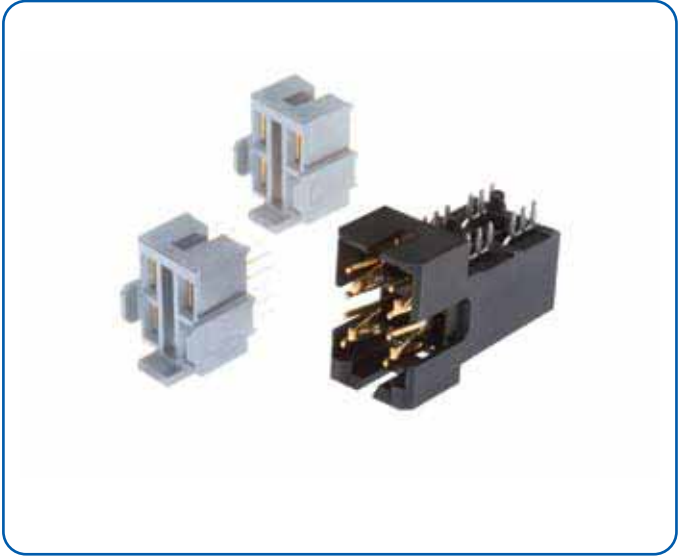

### TECHNICAL DATA

#### PHYSICAL

- Contacts: Copper Alloy
- Plating:
  - Gold over nickel on separable interface
  - Tin-lead over nickel on press-fit tails
- Housing: High temperature thermoplastic, UL 94V-0 compliant
- Performance level Telcordia CO

#### ELECTRICAL (see table below)

#### MECHANICAL PERFORMANCE

- Mating force: 31.2N max per connector
- Unmating force: 9.0N min per connector
- Press-fit insertion force: 67N max per individual contact tail

#### PACKAGING

- Tubes

#### PROCESSING INFORMATION

- Applicable process: wave/IR / vapor phase

#### REFERENCE DATA

- Product Specification GS-12-220
- Application Specification GS-20-023
- Safety UL 60950 & IEC 60950-1 Prevention of Operator Access to Energized Parts

### MATING DATA

#### Receptacle, page 151

- Vertical receptacle, 8,0 mm mating length, 10009536-001
- Vertical receptacle, 6,5 mm mating length, 10009536-002
- Vertical receptacle, fmlb, 10025058-XXXX

### ELECTRICAL

number of connectors, Fully powered	copper pad weight	Current ratings (max. Amps per contact)	
		1 x 2	2 x 2
1	5 oz, double sided	40	20
up to 5 adjacent	5 oz, double sided	32	14
1	2 oz, double sided	32	15
up to 5 adjacent	2 oz, double sided	27	12

# Header, High Power

## PRODUCT

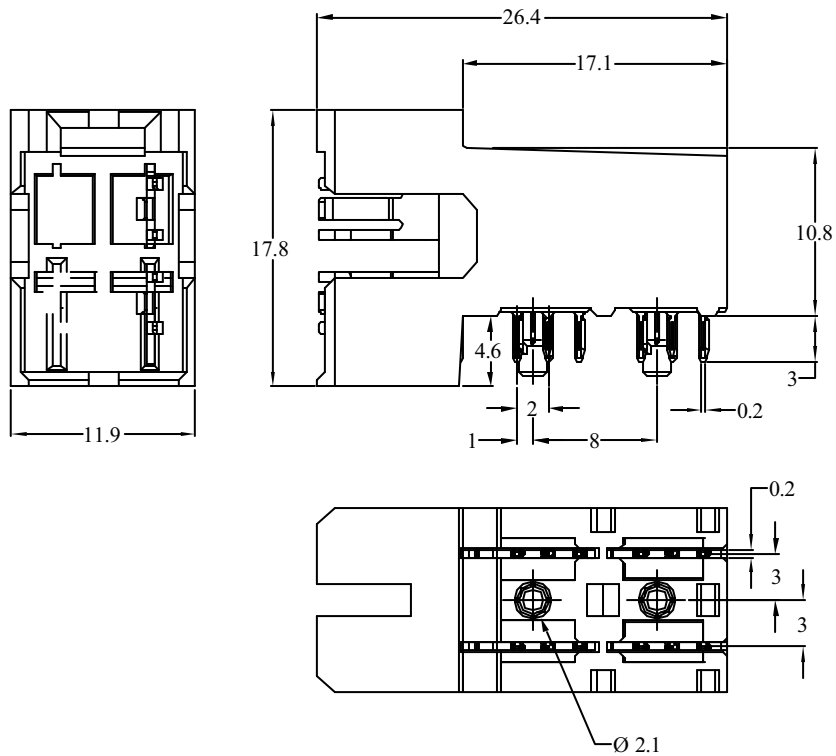

PCB pattern P23, see chapter PCB layouts

## PARTNUMBERS

10009542-001LF

10009556-001LF

Base Part Number

Configuration

LF

LF = lead free

part number	Description
10009542-001LF	Right-angle header, 2x2 Contacts
10009556-001LF	Right-angle header, 1x2 Contacts

## Receptacle, High Power

### FEATURES

- Available in 1x2 or 2x2 contact configurations
- Rated for up to 80 Amps current for a single module
- Voltage Rating: 150V
- Receptacle connectors can be provided with two contact lengths to enable first-mate/last break sequencing
- Protected backplane receptacle connector is UL 60950 (Finger Probe) compliant
- Layout compatible with Metral 2mm backplane connector family
- Press-fit termination

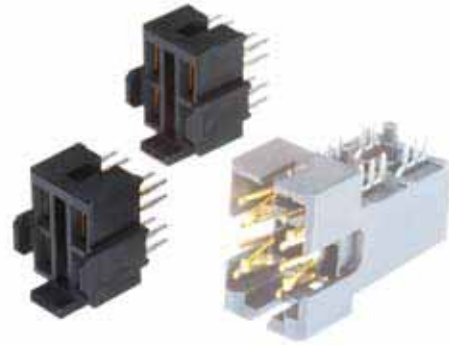

### TECHNICAL DATA

#### PHYSICAL

- Contacts: Copper Alloy
- Plating:
  - Gold over nickel on separable interface
  - Tin-lead over nickel on press-fit tails
- Housing: High temperature thermoplastic, UL 94V-0 compliant
- Performance level Telcordia CO

#### ELECTRICAL (see table below)

#### MECHANICAL PERFORMANCE

- Mating force: 31.2N max per connector
- Unmating force: 9.0N min per connector
- Press-fit insertion force: 67N max per individual contact tail

#### PACKAGING

- Tubes

#### PROCESSING INFORMATION

- Applicable process: wave/IR / vapor phase

#### REFERENCE DATA

- Product Specification GS-12-220
- Application Specification GS-20-023
- Safety UL 60950 & IEC 60950-1 Prevention of Operator Access to Energized Parts

### MATING DATA

#### Header, page 149

- right angle header, 2 x 2 contacts, partnumber, 10009452-001
- right angle header, 1 x 2 contacts, partnumber, 10009556-001

### ELECTRICAL

number of connectors, Fully powered	copper pad weight	Current ratings (max. Amps per contact)	
		1 x 2	2 x 2
1	5 oz, double sided	40	20
up to 5 adjacent	5 oz, double sided	32	14
1	2 oz, double sided	32	15
up to 5 adjacent	2 oz, double sided	27	12

# Receptacle, High Power

## PRODUCT

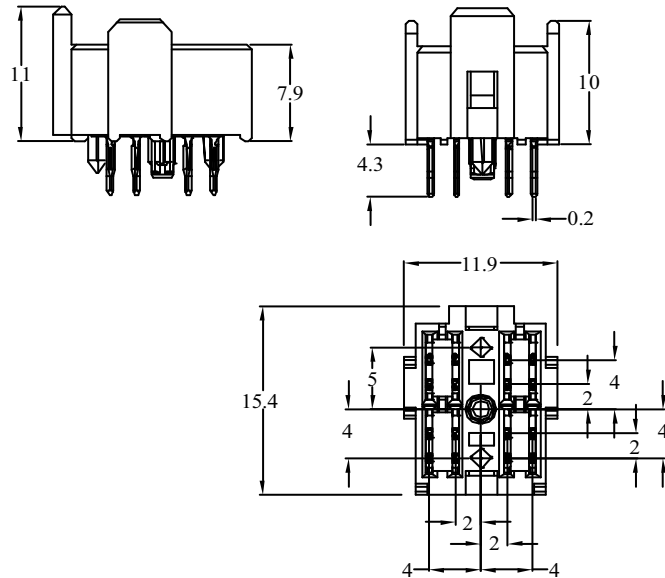

PCB pattern P24, see chapter PCB layouts

## PARTNUMBERS

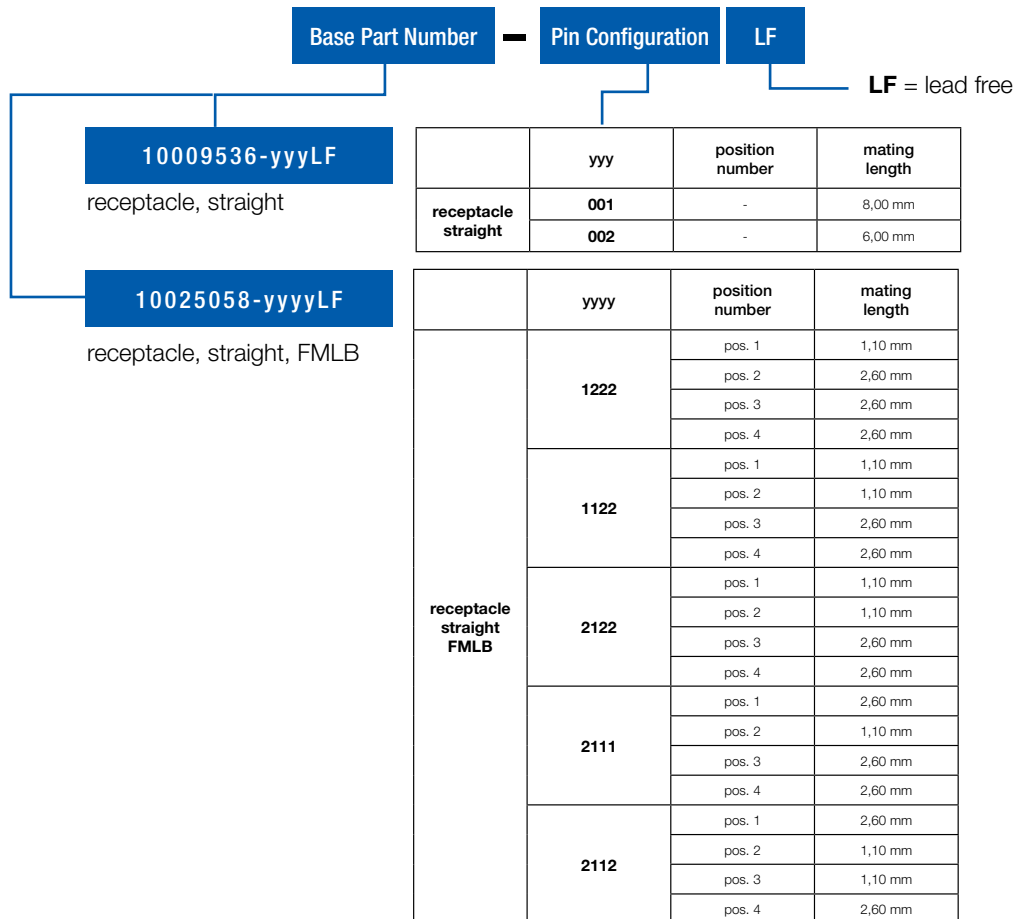





## METRAL® HYBRID CONNECTORS

-  DIN Standard High Power
-  Mini Power
-  DIN Standard Coax
-  Mini Coax

## Header, straight, DIN standard, High Power

### FEATURES

- In accordance with IEC 60917 and IEC 61076-4-104 (Futurebus+)
- Insert according to DIN 41626
- Insert quality tested according to MIL-Std-202 and BS 9525 F0011



### TECHNICAL DATA

#### PHYSICAL

- housing: glass-filled LCP, colour natural
- flammability rating: UL 94 V-0
- contact material: Beryllium Copper
- performance level: Telcordia CO

#### ELECTRICAL

- current rating: up to 40 A
- insulation resistance:  $5 \times 10^3 \text{ M}\Omega$  initially,  $1 \times 10^3 \text{ M}\Omega$  after tests
- withstanding voltage: 1000 V rms (sea level)

#### MECHANICAL PERFORMANCE

- Recommended hole diameter:  $1,00 \pm 0,1 \text{ mm}$

#### ENVIRONMENTAL

- Operating temperature  $-55^\circ\text{C}$  to  $+125^\circ\text{C}$
- RoHs information, this product is compatible according to the European Union Directive 2002/95/IEC

#### PACKAGING

- Standard boxes/bags

#### PROCESSING INFORMATION

- Applicable process: assemble to board

#### APPLICATION EQUIPMENT

- for application equipment, check out the application equipment table on page 217-223

### MATING DATA

- Hybrid DIN standard receptacle, High power right angle, page 157

- Receptacle power insert right angle, solder to board 85995-103LF
- Receptacle power insert, right angle, solder to board , feed-through 70424-003LF

### TYPICAL APPLICATIONS

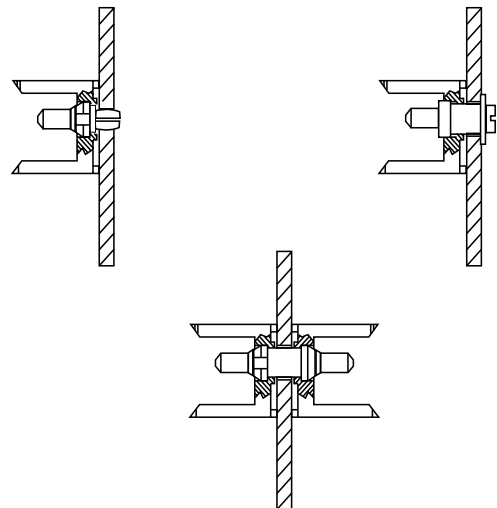



# Header, straight, DIN standard, High Power

## PRODUCT

### Wide Body Housing

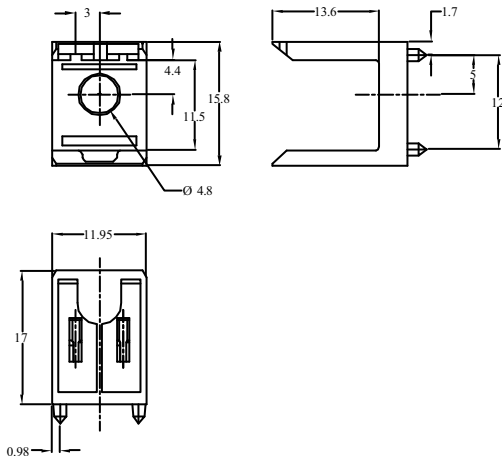

### Narrow Body Housing

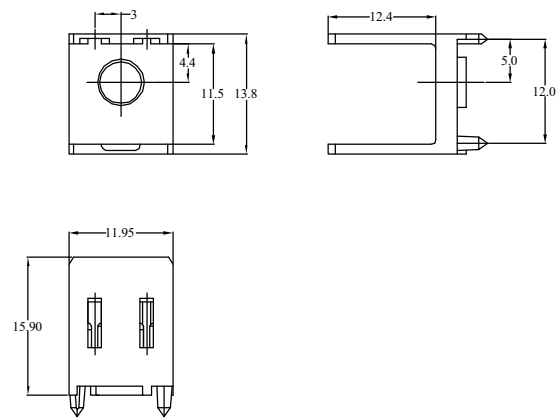

PCB pattern P9, see chapter PCB layouts

### Power insert, straight, press fit

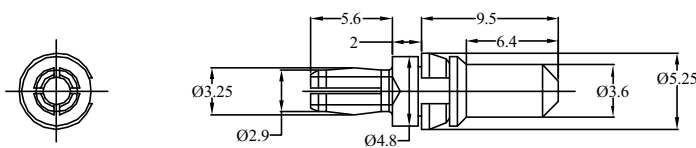

### Power coupler

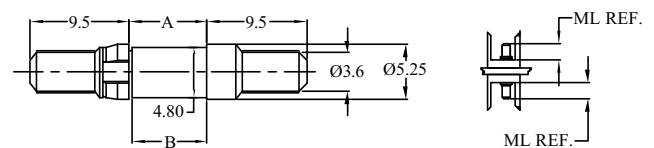

### Screw to board, high power straight plug

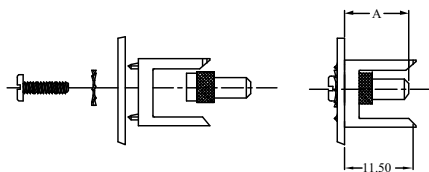

POWER PIN ASSEMBLY  
STYLE A

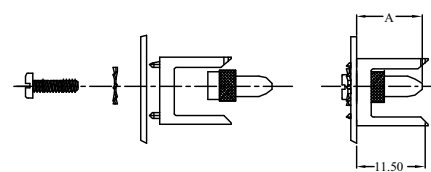

POWER PIN ASSEMBLY  
STYLE B

## PARTNUMBERS

### Housings

Partnumber	Description
70290-001LF	narrow body housing
88911-101LF	wide body housing

### Power inserts

Partnumber	Description	Current rating	PCB thickness
85977-001LF	power insert straight press-fit	30 A	-
70201-001LF	power coupler	40 A	1,6 mm

  

Partnumber	Description	mating length	dimension A
91570-001LF	screw to board high power straight plug	8,00 mm	11,50 mm

## Receptacle, Right angle, DIN standard, High Power

### FEATURES

- In accordance with IEC 60917 and IEC 61076-4-104 (Futurebus+)
- Insert according to DIN 41626
- Insert quality tested according to MIL-Std-202 and BS 9525 F0011

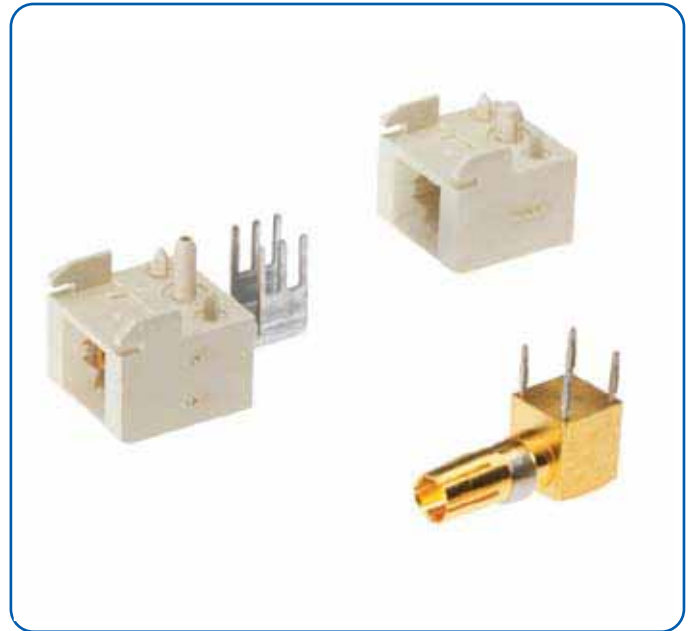

### TECHNICAL DATA

#### PHYSICAL

- housing: glass-filled LCP, colour natural
- flammability rating: UL 94 V-0
- contact material: Beryllium Copper
- performance level: Telcordia CO

#### ELECTRICAL

- current rating: up to 40 A
- insulation resistance:  $5 \times 10^3 \text{ M}\Omega$  initially,  $1 \times 10^3 \text{ M}\Omega$  after tests
- withstanding voltage: 1000 V rms (sea level)

#### MECHANICAL PERFORMANCE

- Recommended hole diameter:  $1,00 \pm 0,1 \text{ mm}$

#### ENVIRONMENTAL

- Operating temperature  $-55^\circ\text{C}$  to  $+125^\circ\text{C}$
- RoHs information, this product is compatible according to the European Union Directive 2002/95/IEC

#### PACKAGING

- Standard boxes/bags

#### PROCESSING INFORMATION

- Applicable process: wave / IR / vapor phase / press-fit

#### APPLICATION EQUIPMENT

- for application equipment, check out the application equipment table on page 217-223

### MATING DATA

- High power plug insert, page 155
- partnumber, 91570-001LF

### TYPICAL APPLICATIONS

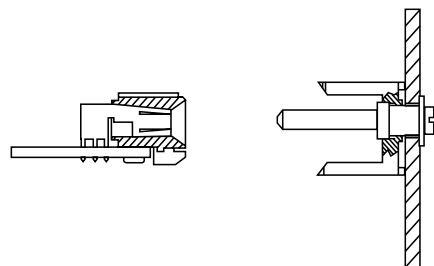

# Receptacle, Right angle, DIN standard, High Power

## PRODUCT

### Housings

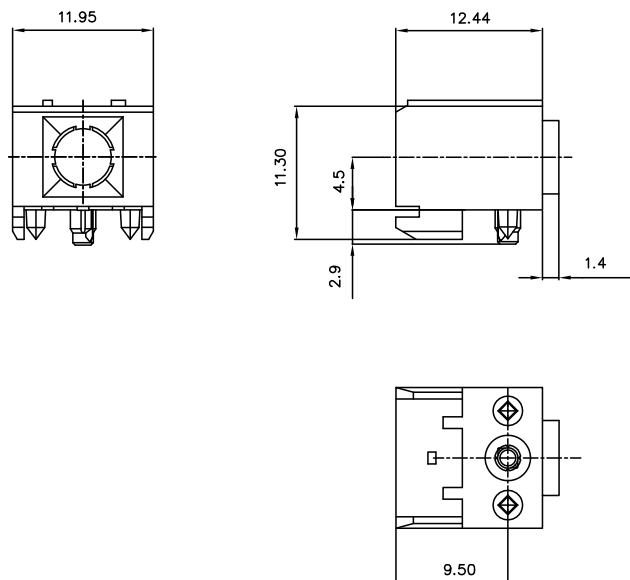

### Power inserts

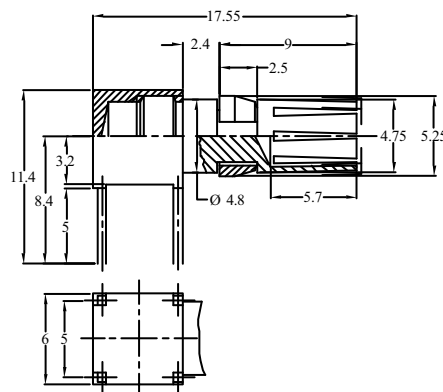

### KIT, pre-assembled housings & inserts

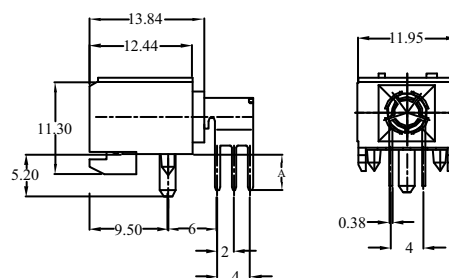

PCB pattern P8 / P10, see chapter PCB layouts

## PARTNUMBERS

### Housings

Partnumber	Description	Feature
89092-101LF	receptacle housing	press-peg

### Power inserts

Partnumber	Description	Current rating	PCB thickness
85995-103LF	receptacle power insert right angle solder to board	40 A	-

### KIT, pre-assembled housings & inserts

Partnumber	Description	Current rating	PCB thickness
70424-003LF	receptacle power insert RA solder to board, feed through	30 A	1,6 mm

## Header, Mini power

### FEATURES

- In accordance with IEC 60917 and IEC 61076-4-104 (Futurebus+)
- Insert according to DIN 41626
- Insert quality tested according to MIL-Std-202 and BS 9525 F0011

### TECHNICAL DATA

#### PHYSICAL

- Housing material: glass filled LCP
- Flammability rating: UL 94 V-0
- Insert material shell Copper zinc 39 Pb 2
- Spring : Beryllium copper
- Insulator: PTFE Teflon
- Clip: BerylliumCopper
- Performance level Telcordia CO

#### ELECTRICAL (see table below)

#### MECHANICAL PERFORMANCE

- Insertion force, 0.9 N
- Extraction Force 0.9 N

#### PACKAGING

- Standard boxes/bags

#### PROCESSING INFORMATION

- Applicable process: wave/IR / vapor phase / press-fit

#### REFERENCE DATA

- Application Specification TA-0941

#### APPLICATION EQUIPMENT

- for application equipment, check out the application equipment table on page 217-223

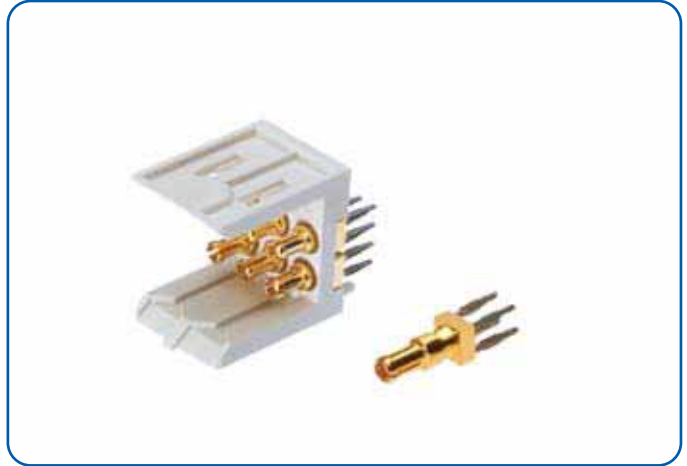

### MATING DATA

- Housing, page 161
  - partnumber 70244-102
- Insert, page 161
  - partnumber 85976-001LF
  - partnumber 85976-002 LF

### TYPICAL APPLICATIONS

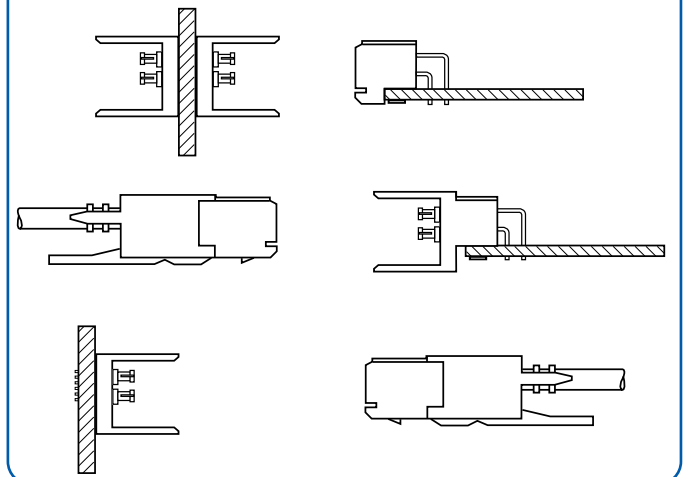

### ELECTRICAL

<b>Electrical characteristic impedance</b>	50 Ω	75 Ω
<b>Working frequency</b>	0 - 10 GHz	0 - 1,5 GHz
<b>Reflection coefficient</b>	max.0,05 up to 1 GHz; max. 0,01 up to 10 Ghz	max.0,01 up to 1,5 GHz
<b>Peak voltage</b>	750 V eff.	750 V eff.
<b>Operating voltage</b>	250 V eff.	250 V eff.
<b>Insulation resistance</b>	1 x 10 <sup>3</sup> MΩ initially,	1 x 10 <sup>3</sup> MΩ initially,
<b>Temperature range</b>	-65°C to +165°C	-65°C to +165°C

# Header, Mini power

## PRODUCT

### Housings Straight

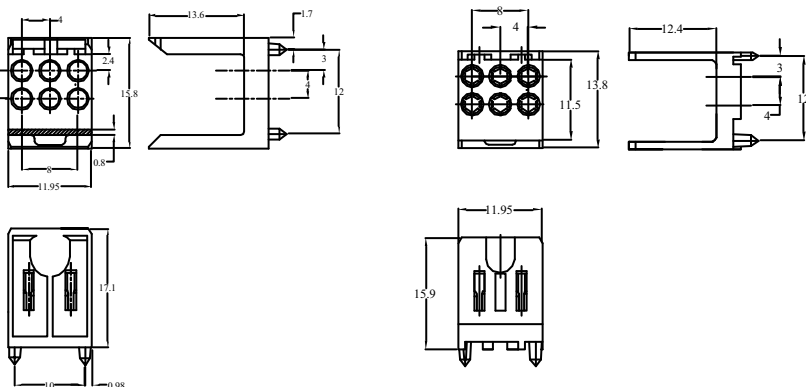

### Housings Right angle

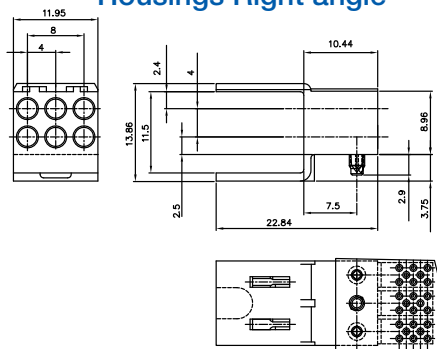

PCB pattern P12, see chapter PCB layouts

### Inserts Straight

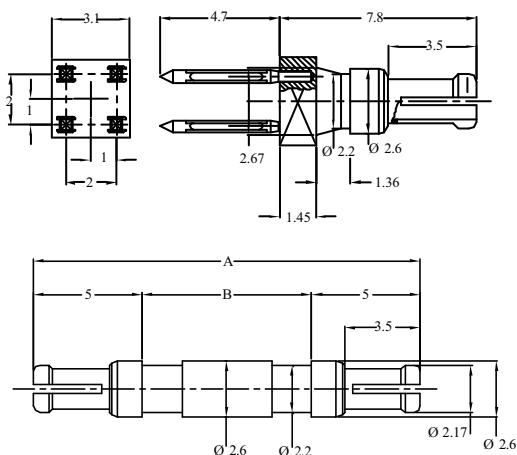

### Inserts Right angle

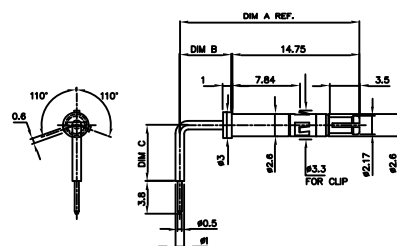

## PARTNUMBERS

### Housings Straight

Partnumber	Description
88913-111LF	6 position STR header-wide body-STB
70243-111LF	6 position STR header-narrow body-STB

### Inserts Straight

Partnumber	Description	(tail) length	PCB thickness
85973-001LF	Mini power STR insert- PF	4,45 mm	-
85972-001LF	Mini power plug/coupler	17,40 mm	1,6 mm

### Housings Right angle

Partnumber	Description
88982-102LF	6 position RA header-press peg

### Inserts Right angle

Partnumber	Description	Tail length	PCB thickness
85975-001LF	Mini power RA insert, row A	3,8 mm	2,4 mm
85975-002LF	Mini power RA insert, row B	3,8 mm	2,4 mm

RA = right angle, STR = straight, STB = solder-to-board, PF = press-fit

## Receptacle, Mini Power

### FEATURES

- In accordance with IEC 60917 and IEC 61076-4-104 (Futurebus+)
- Insert according to DIN 41626
- Insert quality tested according to MIL-Std-202 and BS 9525 F0011



### TECHNICAL DATA

#### PHYSICAL

- Housing material: glass filled LCP
- Flammability rating: UL 94 V-0
- Insert material shell Copper zinc 39 Pb 2
- Spring : Beryllium copper
- Insulator: PTFE Teflon
- Clip: BerylliumCopper
- Performance level Telcordia CO

#### ELECTRICAL (see table below)

#### MECHANICAL PERFORMANCE

- Insertion force, 0.9 N
- Extraction Force 0.9 N

#### PACKAGING

- Standard boxes/bags

#### PROCESSING INFORMATION

- Applicable process: wave/IR / vapor phase

#### REFERENCE DATA

- Application Specification TA-0941

#### APPLICATION EQUIPMENT

- for application equipment, check out the application equipment table on page 217-223

### MATING DATA

#### ■ Straight, page 159

- housing, partnumber 88913-111LF
- insert, partnumber 85973-001LF

#### ■ Right angle, page 159

- housing, partnumber 88982-102LF
- insert, partnumber 85975-001LF
- insert, partnumber 85975-002LF

### TYPICAL APPLICATIONS

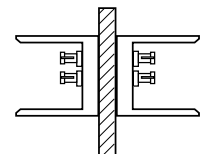
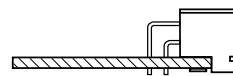

### ELECTRICAL

<b>Electrical characteristic impedance</b>	50 Ω	75 Ω
<b>Working frequency</b>	0 - 10 GHz	0 - 1,5 GHz
<b>Reflection coefficient</b>	max.0,05 up to 1 GHz; max. 0,01 up to 10 Ghz	max.0,01 up to 1,5 GHz
<b>Peak voltage</b>	750 V eff.	750 V eff.
<b>Operating voltage</b>	250 V eff.	250 V eff.
<b>Insulation resistance</b>	1 x 10 <sup>3</sup> MΩ initially,	1 x 10 <sup>3</sup> MΩ initially,
<b>Temperature range</b>	-65°C to +165°C	-65°C to +165°C

# Receptacle, Mini Power

## PRODUCT

### Housings

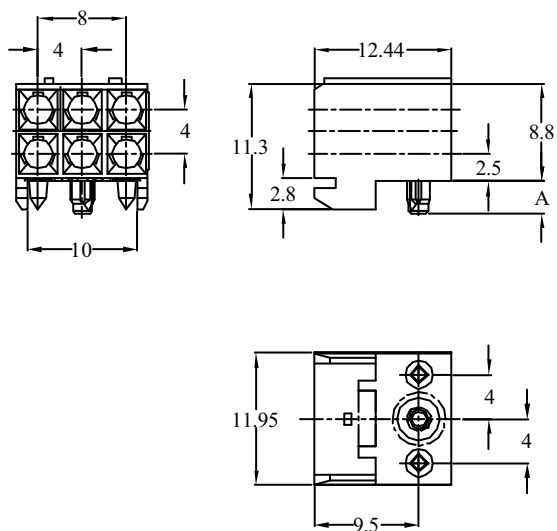

### Inserts

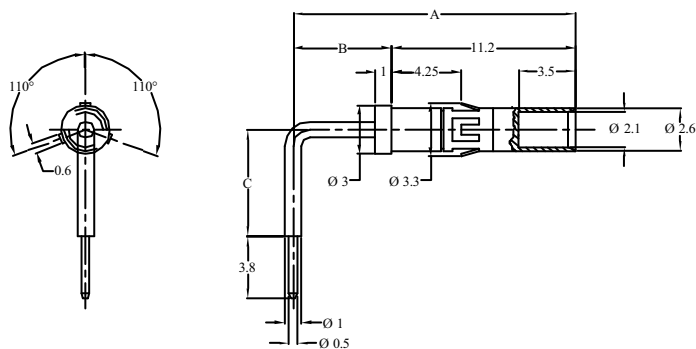

PCB pattern P20, see chapter PCB layouts

## PARTNUMBERS

### Housings

Partnumber	Description
70244-102LF	6 position RA housing

### Inserts

Partnumber	Description	tail length	PCB thickness
85976-001LF	Mini power RA insert- 2 position, row A	3,8 mm	2,6 mm
85976-002LF	Mini power RA insert- 2 position, row B	3,8 mm	2,4 mm

RA = right angle, STR = straight, STB = solder-to-board, PF = press-fit

## Header, straight, DIN standard, Coax

### FEATURES

- ▶ In accordance with IEC 60917 and IEC 61076-4-104 (Futurebus+)
- ▶ Insert according to DIN 41626
- ▶ Insert quality tested according to MIL-Std-202 and BS 9525 F0011



### TECHNICAL DATA

#### PHYSICAL

- ▶ Housing material: glass filled LCP
- ▶ Flammability rating: UL 94 V-0
- ▶ Insert material shell Copper zinc 39 Pb 2
- ▶ Spring : Beryllium copper
- ▶ Insulator: PTFE Teflon
- ▶ Clip: BerylliumCopper
- ▶ Performance level Telcordia CO

#### ELECTRICAL (see table below)

#### MECHANICAL PERFORMANCE

- ▶ Insertion force, 0.9 N
- ▶ Extraction Force 0.9 N

#### PACKAGING

- ▶ Standard boxes/bags

#### PROCESSING INFORMATION

- ▶ Applicable process: assemble to board

#### REFERENCE DATA

- ▶ Application Specification TA-0941

#### APPLICATION EQUIPMENT

- ▶ for application equipment, check out the application equipment table on page 217-223

### MATING DATA

#### ▶ Right angle, solder to board, page 165

- ▶ housing, partnumber 89092-101LF
- ▶ insert, partnumber 93904-001LF

#### ▶ Right angle, press-fit, page 165

- ▶ housing, partnumber 89082-101LF
- ▶ insert, partnumber 72096-101LF

### TYPICAL APPLICATIONS

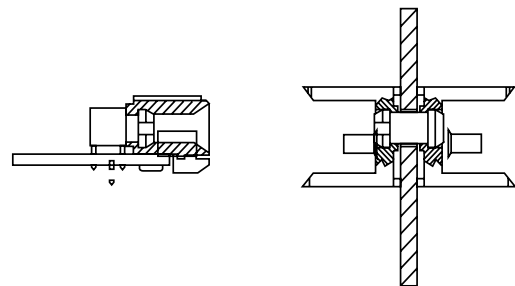

### ELECTRICAL

<b>Electrical characteristic impedance</b>	50 Ω	75 Ω
<b>Working frequency</b>	0 - 10 GHz	0 - 1,5 GHz
<b>Reflection coefficient</b>	max.0,05 up to 1 GHz; max. 0,01 up to 10 Ghz	max.0,01 up to 1,5 GHz
<b>Peak voltage</b>	750 V eff.	750 V eff.
<b>Operating voltage</b>	250 V eff.	250 V eff.
<b>Insulation resistance</b>	1 x 10 <sup>3</sup> MΩ initially,	1 x 10 <sup>3</sup> MΩ initially,
<b>Temperature range</b>	-65°C to +165°C	-65°C to +165°C



# Header, straight, DIN standard, Coax

## PRODUCT

### Wide Body Housing

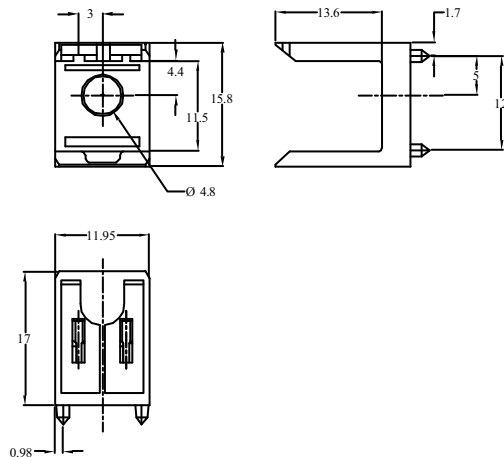

### Narrow Body Housing

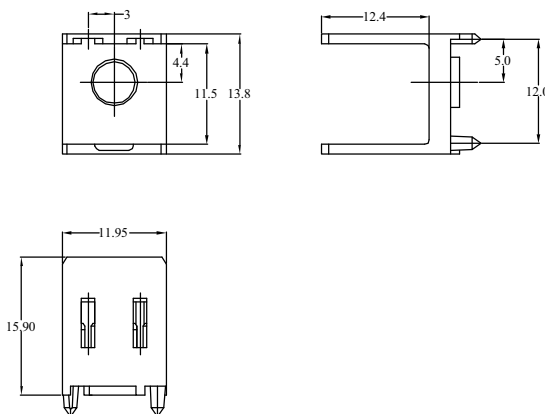

PCB pattern P9, see chapter PCB layouts

### Coax inserts

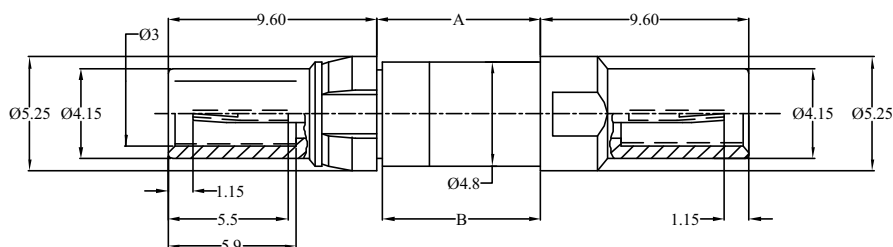

## PARTNUMBERS

### Housings

Partnumber	Description
<b>70290-001LF</b>	Header STR-narrow body
<b>88911-101LF</b>	Header STR-wide body

### Coax inserts

Partnumber	Description	impedance	length	PCB thickness
<b>70200-005LF</b>	receptacle/receptacle coax coupler	50 Ω	28,4 mm	4,8 mm
<b>70212-005LF</b>	receptacle/receptacle coax coupler	75 Ω	28,3 mm	4,8 mm

RA = right angle, STR = straight, STB = solder-to-board, PF = press-fit

## Receptacle, right angle, DIN standard, Coax

### FEATURES

- In accordance with IEC 60917 and IEC 61076-4-104 (Futurebus+)
- Insert according to DIN 41626
- Insert quality tested according to MIL-Std-202 and BS 9525 F0011

### TECHNICAL DATA

#### PHYSICAL

- Housing material: glass filled LCP
- Flammability rating: UL 94 V-0
- Insert material shell Copper zinc 39 Pb 2
- Spring : Beryllium copper
- Insulator: PTFE Teflon
- Clip: BerylliumCopper
- Performance level Telcordia CO

#### ELECTRICAL (see table below)

#### MECHANICAL PERFORMANCE

- Insertion force, 0.9 N
- Extraction Force 0.9 N

#### PACKAGING

- Standard boxes/bags

#### PROCESSING INFORMATION

- Applicable process: wave/IR / vapor phase / press-fit

#### REFERENCE DATA

- Application Specification TA-0941

#### APPLICATION EQUIPMENT

- for application equipment, check out the application equipment table on page 217-223



### MATING DATA

- Hybrid DIN standard receptacle, coax, page 163

- housing, partnumber 88911-101LF
- coupler, partnumber 70200-001LF

### TYPICAL APPLICATIONS

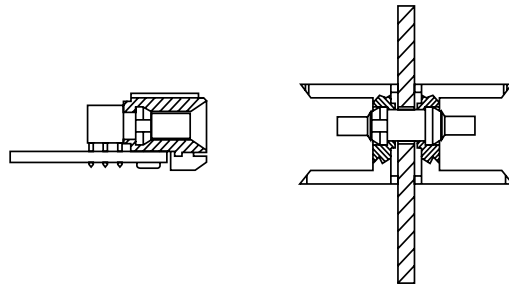

### ELECTRICAL

<b>Electrical characteristic impedance</b>	50 Ω	75 Ω
<b>Working frequency</b>	0 - 10 GHz	0 - 1,5 GHz
<b>Reflection coefficient</b>	max.0,05 up to 1 GHz; max. 0,01 up to 10 Ghz	max.0,01 up to 1,5 GHz
<b>Peak voltage</b>	750 V eff.	750 V eff.
<b>Operating voltage</b>	250 V eff.	250 V eff.
<b>Insulation resistance</b>	1 x 10 <sup>3</sup> MΩ initially,	1 x 10 <sup>3</sup> MΩ initially,
<b>Temperature range</b>	-65°C to +165°C	-65°C to +165°C

# Receptacle, right angle, DIN standard, Coax

## PRODUCT

### Housings

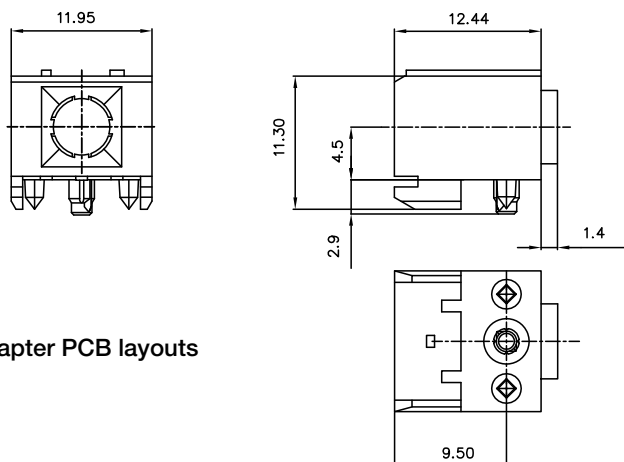

PCB pattern P10, see chapter PCB layouts

### Coax inserts

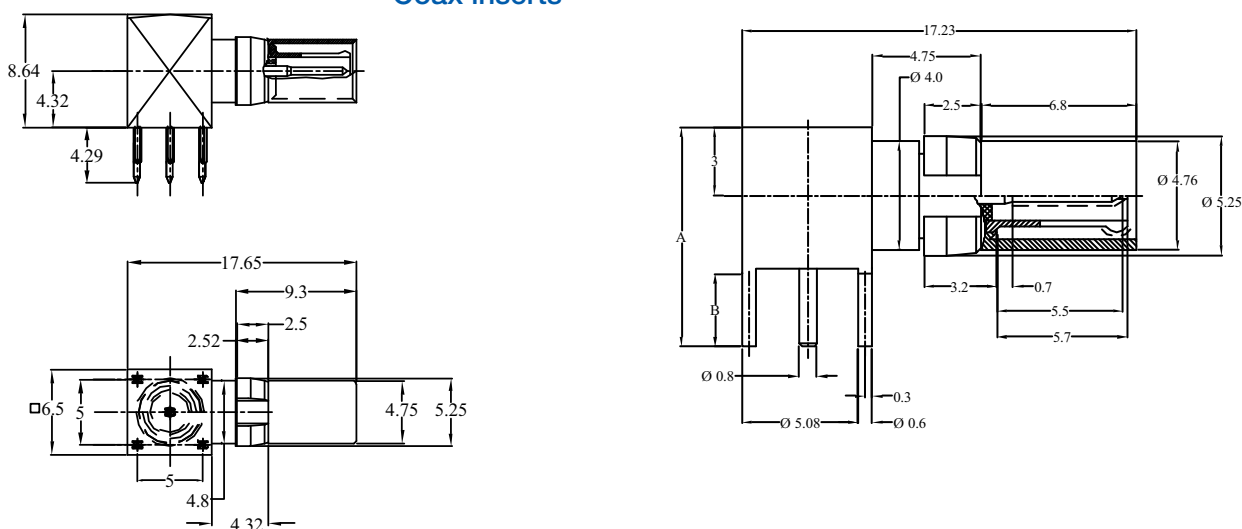

## PARTNUMBERS

### Housings

Partnumber	Description
89092-101LF	receptacle housing STR

### Coax inserts

Partnumber	Description	impedance
93904-001LF	header coax insert STR stb	50 Ω
93903-001LF	header coax insert STR stb	75 Ω
72096-101LF	header coax insert STR pf	50 Ω

RA = right angle, STR = straight, STB = solder-to-board, PF = press-fit

## Header, Mini Coax

### FEATURES

- In accordance with IEC 60917 and IEC 61076-4-104 (Futurebus+)
- Insert according to DIN 41626
- Insert quality tested according to MIL-Std-202 and BS 9525 F0011

### TECHNICAL DATA

#### PHYSICAL

- Housing material: glass filled LCP
- Flammability rating: UL 94 V-0
- Insert material shell Copper zinc 39 Pb 2
- Spring : Beryllium copper
- Insulator: PTFE Teflon
- Clip: BerylliumCopper
- Performance level Telcordia CO

#### ELECTRICAL (see table below)

#### MECHANICAL PERFORMANCE

- Insertion force, 0.9 N
- Extraction Force 0.9 N

#### PACKAGING

- Standard boxes/bags

#### PROCESSING INFORMATION

- Applicable process: wave/IR / vapor phase / press-fit

#### REFERENCE DATA

- Application Specification TA-0941

#### APPLICATION EQUIPMENT

- for application equipment, check out the application equipment table on page 217-223



### MATING DATA

#### Right angle, page 169

- housing, partnumber 70244-102LF
- insert, partnumber 70239-001LF

### TYPICAL APPLICATIONS

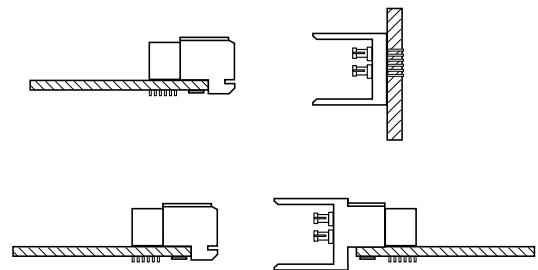

### ELECTRICAL

<b>Electrical characteristic impedance</b>	50 Ω	75 Ω
<b>Working frequency</b>	0 - 10 GHz	0 - 1,5 GHz
<b>Reflection coefficient</b>	max.0,05 up to 1 GHz; max. 0,01 up to 10 Ghz	max.0,01 up to 1,5 GHz
<b>Peak voltage</b>	750 V eff.	750 V eff.
<b>Operating voltage</b>	250 V eff.	250 V eff.
<b>Insulation resistance</b>	1 x 10 <sup>3</sup> MΩ initially,	1 x 10 <sup>3</sup> MΩ initially,
<b>Temperature range</b>	-65°C to +165°C	-65°C to +165°C

# Header, Mini Coax

## PRODUCT

### Housings Straight

### Housings Right angle

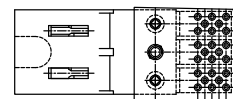
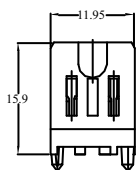
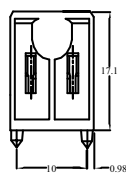
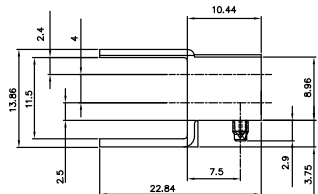
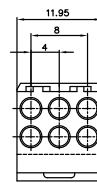
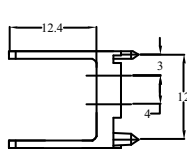
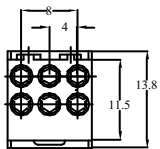
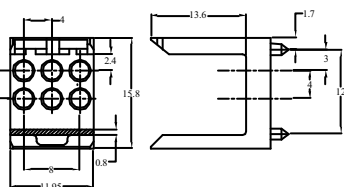

PCB pattern P12, see chapter PCB layouts

### Inserts Straight

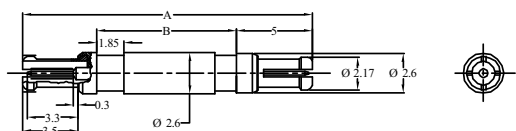
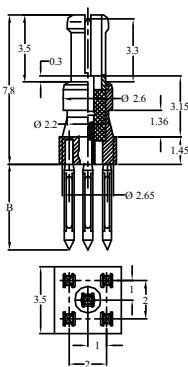
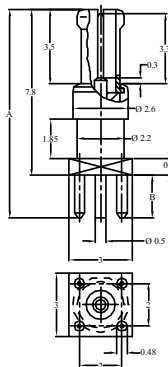

### Inserts Right angle

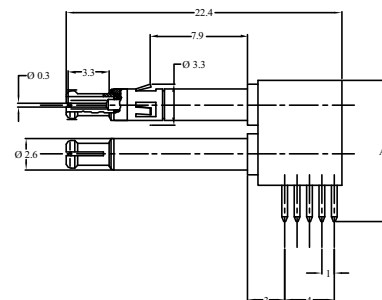
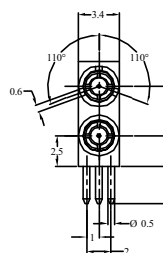

## PARTNUMBERS

### Housings Straight

Partnumber	Description
88913-101LF	6 position STR header-wide body-STB
88913-111LF	6 position STR header-wide body-PF
70243-101LF	6 position STR header-narrow body-STB
70243-111LF	6 position STR header-narrow body-PF

### Inserts Straight

Partnumber	Description	length	PCB thickness
88980-002LF	Mini Coax STR insert- STB	-	1,6 mm
88978-001LF	Mini Coax STR insert- PF	-	-
88971-003LF	Mini Coax STR plug/plug coupler	17,40 mm	1,6 mm

### Housings Right angle

Partnumber	Description
88982-102LF	6 position RA header-press peg

### Inserts Right angle

Partnumber	Description	Tail length	PCB thickness
88983-001LF	Mini Coax RA insert- STB	2,80 mm	1,6 mm

RA = right angle, STR = straight, STB = solder-to-board, PF = press-fit

## Receptacle, Mini Coax

### FEATURES

- ▶ In accordance with IEC 60917 and IEC 61076-4-104 (Futurebus+)
- ▶ Insert according to DIN 41626
- ▶ Insert quality tested according to MIL-Std-202 and BS 9525 F0011

### TECHNICAL DATA

#### PHYSICAL

- ▶ Housing material: glass filled LCP
- ▶ Flammability rating: UL 94 V-0
- ▶ Insert material shell Copper zinc 39 Pb 2
- ▶ Spring : Beryllium copper
- ▶ Insulator: PTFE Teflon
- ▶ Clip: BerylliumCopper
- ▶ Performance level Telcordia CO

#### ELECTRICAL (see table below)

#### MECHANICAL PERFORMANCE

- ▶ Insertion force, 0.9 N
- ▶ Extraction Force 0.9 N

#### PACKAGING

- ▶ Standard boxes/bags

#### PROCESSING INFORMATION

- ▶ Applicable process: wave/IR / vapor phase

#### REFERENCE DATA

- ▶ Application Specification TA-0941

#### APPLICATION EQUIPMENT

- ▶ for application equipment, check out the application equipment table on page 217-223



### MATING DATA

#### ▶ Straight, page 167

- ▶ housing, partnumber 88913-111LF
- ▶ insert, partnumber 88978-001LF

#### ▶ Right angle, page 167

- ▶ housing, partnumber 88982-102LF
- ▶ insert, partnumber 89030-001LF

### TYPICAL APPLICATIONS

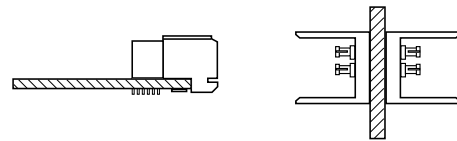

### ELECTRICAL

<b>Electrical characteristic impedance</b>	50 Ω	75 Ω
<b>Working frequency</b>	0 - 10 GHz	0 - 1,5 GHz
<b>Reflection coefficient</b>	max.0,05 up to 1 GHz; max. 0,01 up to 10 Ghz	max.0,01 up to 1,5 GHz
<b>Peak voltage</b>	750 V eff.	750 V eff.
<b>Operating voltage</b>	250 V eff.	250 V eff.
<b>Insulation resistance</b>	1 x 10 <sup>3</sup> MΩ initially,	1 x 10 <sup>3</sup> MΩ initially,
<b>Temperature range</b>	-65°C to +165°C	-65°C to +165°C

# Receptacle, Mini Coax

## PRODUCT

### Housings

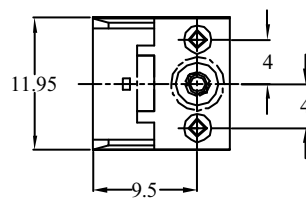
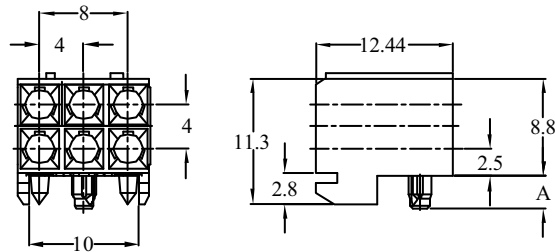

PCB pattern P12, see chapter PCB layouts

### Inserts

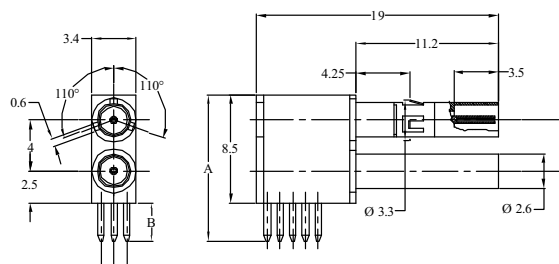

## PARTNUMBERS

### Housings

Partnumber	Description
70244-102LF	6 position RA housing

### Inserts

Partnumber	Description	type	PCB thickness
70239-001LF	Mini Coax RA insert- 2 position	STB	1,6 mm



RA = right angle, STR = straight, STB = solder-to-board, PF = press-fit



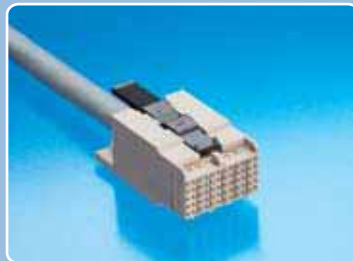



## METRAL® CABLE CONNECTORS

-  Cable connectors, Signal
-  Cable connectors, Shielded

## Cable Connectors, 4 row, signal

### FEATURES

- ▶ Interface compatible with IEC 61076-4-104 backpanel connectors
- ▶ Next generation design offers easy and fast cable assembly
- ▶ Four Row versions provide 24 or 48 dual beam contacts
- ▶ Insulation displacement design offers quick termination without the need to strip conductors
- ▶ Active backshell latches securely connect assembled cable connectors to standard Metral® headers
- ▶ Different latch designs are available to satisfy ergonomic and mechanical requirements
- ▶ End-stackable cable connectors enable adjacent connectors to plug to headers without loss of positions
- ▶ Application tooling supported by FCI

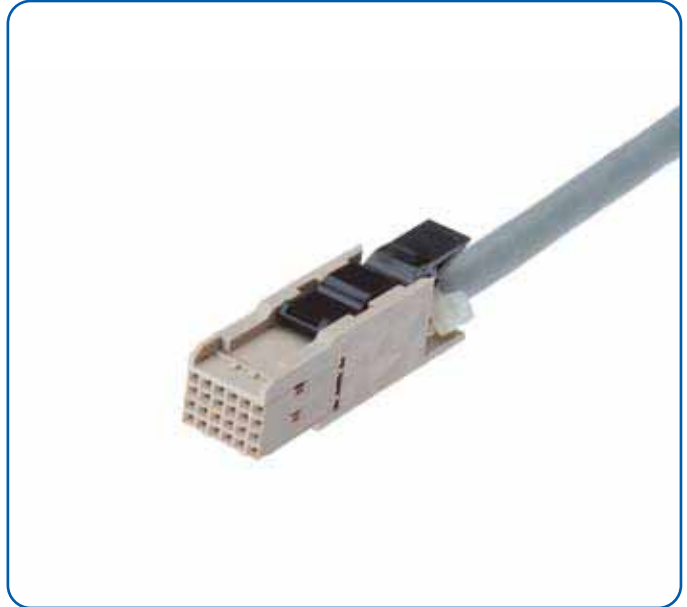

### TECHNICAL DATA

#### PHYSICAL

- ▶ spacing: 2,00 mm x 2,00 mm
- ▶ contact material: Phosphor bronze
- ▶ contact plating: Gold over nickel on mating face; pure tin over nickel in termination area
- ▶ housing Material: Glass filled 612 Polyamide UL 94-V0
- ▶ performance level: Telcordia CO

#### ELECTRICAL

- ▶ current Rating: 1.0A per contact
- ▶ withstanding Voltage: 1000 VDC
- ▶ insulation resistance: >1000 mega ohms after environmental exposure

#### MECHANICAL PERFORMANCE

- ▶ mating force: <1.0 Newtons per contact
- ▶ un-mating force: >.2 Newtons per contact; <1.13 Newtons per contact
- ▶ IDC termination retention: <.89 Newtons per contact
- ▶ durability: 200 cycles (Telcordia)
- ▶ temperature: -55C to +105 C

#### ENVIRONMENTAL

- ▶ meets Telcordia Central Office and IEC Class 1 requirements. Additional platings are also available to meet uncontrolled environmental requirements; consult product drawings and product specifications for the cable connectors and mating headers.

#### PACKAGING

- ▶ kits

#### REFERENCE DATA

- ▶ UL E66906, CSA LR46923
- ▶ Product Specifications: GS-12-015 (4 Row)
- ▶ Application Specifications: GS-20-002 (4 Row)
- ▶ Application tooling: GS-20-003 (4 Row)

#### APPLICATION EQUIPMENT

- ▶ for application equipment, check out the application equipment table on page 217-223

### MATING DATA

- ▶ Header, straight, press-fit, page 27

- ▶ 1 module – part number 70232-116LF
- ▶ 2 modules – part number 70233-116LF
- ▶ 4 modules – part number 70234-116LF
- ▶ 8 modules – part number 70235-116LF

### TYPICAL APPLICATIONS

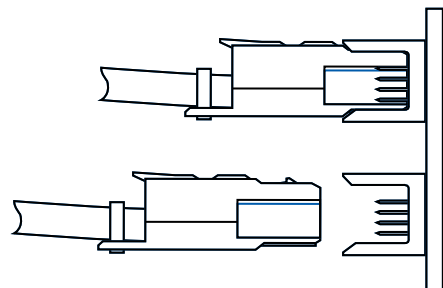

# Cable Connectors, 4 row, signal

## PRODUCT

**1 Module**  
**72476-1yx1LF**

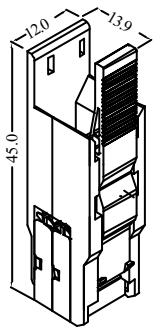

STANDARD LATCH FINGER  
FOR CABLE TIE BELOW  
LATCH FINGER AND EASIEST  
ACCESS TO LATCH FINGER

SHORT LATCH FINGER  
FOR CABLE TIE ABOVE  
LATCH FINGER AND LARGER  
CABLE SIZE CAPACITY

**2 Module**  
**72477-1yx1LF**

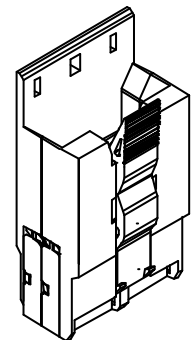
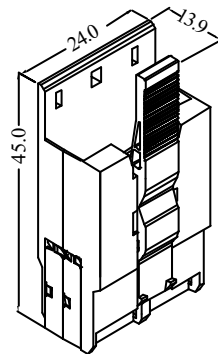

STANDARD LATCH FINGER  
FOR CABLE TIE BELOW  
LATCH FINGER AND EASIEST  
ACCESS TO LATCH FINGER

SHORT LATCH FINGER  
FOR CABLE TIE ABOVE  
LATCH FINGER AND LARGER  
CABLE SIZE CAPACITY

**standard latch** = for cable up to 6.00mm diameter  
**short latch** = for cable up to 9.00mm diameter

## PARTNUMBERS

**72476 - 1yx1LF**

**72477 - 1yx1LF**

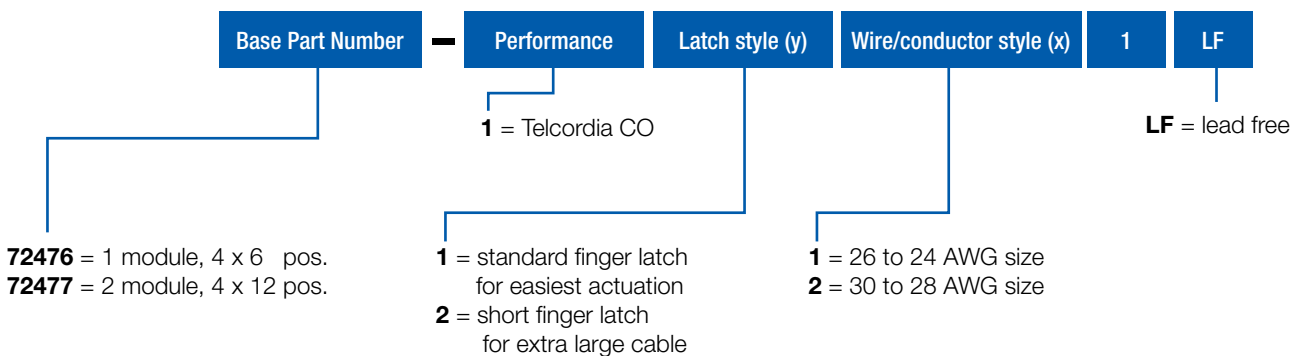

## Cable Connectors, 5 row, signal

### FEATURES

- ▶ Interface compatible with IEC 61076-4-104 backpanel connectors
- ▶ Next generation design offers easy and fast cable assembly
- ▶ Five Row versions provide 30 or 60 dual beam contacts
- ▶ Insulation displacement design offers quick termination without the need to strip conductors
- ▶ Active backshell latches securely connect assembled cable connectors to standard Metral® headers
- ▶ Different latch designs are available to satisfy ergonomic and mechanical requirements
- ▶ End-stackable cable connectors enable adjacent connectors to plug to headers without loss of positions
- ▶ Application tooling supported by FCI

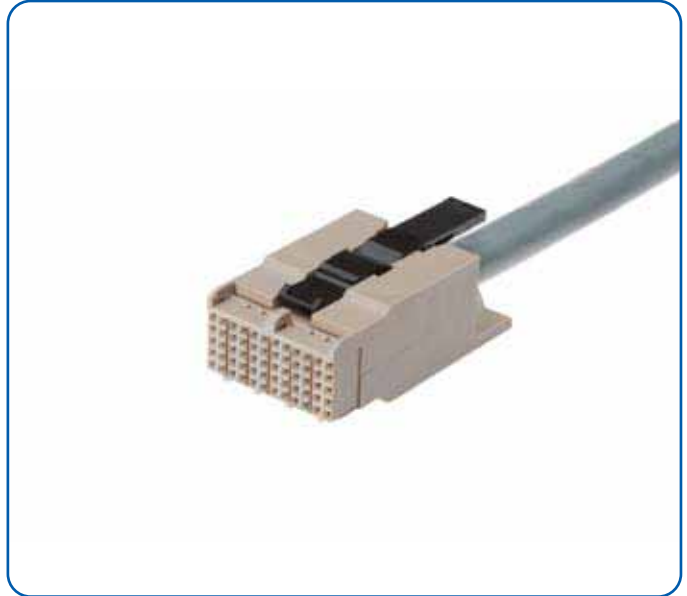

### TECHNICAL DATA

#### PHYSICAL

- ▶ spacing: 2,00 mm x 2,00 mm
- ▶ contact material: Phosphor bronze
- ▶ contact plating: Gold over nickel on mating face; pure tin over nickel in termination area
- ▶ housing Material: Glass filled 612 Polyamide UL 94-V0
- ▶ performance level: Telcordia CO

#### ELECTRICAL

- ▶ current Rating: 1.0A per contact
- ▶ withstanding Voltage: 1000 VDC
- ▶ insulation resistance: >1000 mega ohms after environmental exposure

#### MECHANICAL PERFORMANCE

- ▶ mating force: <1.0 Newtons per contact
- ▶ un-mating force: >.2 Newtons per contact; <1.13 Newtons per contact
- ▶ IDC termination retention: <.89 Newtons per contact
- ▶ durability: 200 cycles (Telcordia)
- ▶ temperature: -55C to +105 C

#### ENVIRONMENTAL

- ▶ meets Telcordia Central Office and IEC Class 1 requirements. Additional platings are also available to meet uncontrolled environmental requirements; consult product drawings and product specifications for the cable connectors and mating headers.

#### PACKAGING

- ▶ kits

#### REFERENCE DATA

- ▶ UL E66906, CSA LR46923
- ▶ Product Specifications: GS-12-016 (5 Row)
- ▶ Applicationspecification: GS-20-003 (5 Row)
- ▶ Application tooling : GS-20-003 (5 Row)

#### APPLICATION EQUIPMENT

- ▶ for application equipment, check out the application equipment table on page 217-223

### MATING DATA

- ▶ Header straight, press-fit, page 41

- ▶ 1 module – part number 89006-116LF
- ▶ 2 modules – part number 89007-116LF
- ▶ 4 modules – part number 89008-116LF
- ▶ 8 modules – part number 89009-116LF

### TYPICAL APPLICATIONS

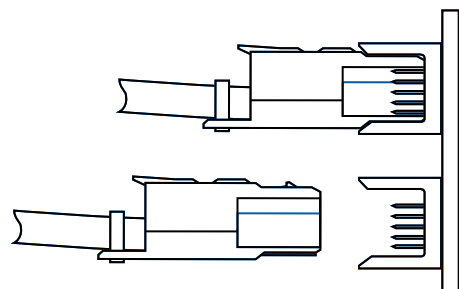

# Cable Connectors, 5 row, signal

## PRODUCT

**1 Module**  
**72478-1yx1LF**

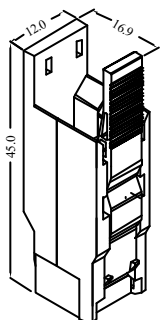

STANDARD LATCH FINGER  
FOR CABLE TIE BELOW  
LATCH FINGER AND EASIEST  
ACCESS TO LATCH FINGER

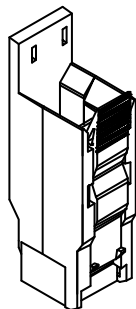

SHORT LATCH FINGER  
FOR CABLE TIE ABOVE  
LATCH FINGER AND LARGER  
CABLE SIZE CAPACITY

**2 Module**  
**72479-1yx1LF**

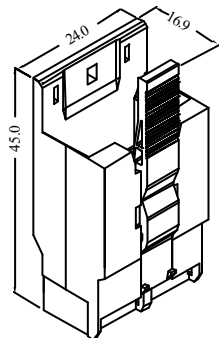

STANDARD LATCH FINGER  
FOR CABLE TIE BELOW  
LATCH FINGER AND EASIEST  
ACCESS TO LATCH FINGER

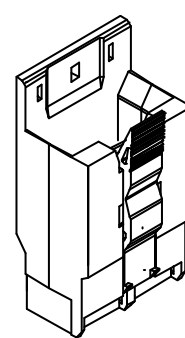

SHORT LATCH FINGER  
FOR CABLE TIE ABOVE  
LATCH FINGER AND LARGER  
CABLE SIZE CAPACITY

**standard latch** = for cable up to 6.00mm diameter  
**short latch** = for cable up to 9.00mm diameter

## PARTNUMBERS

72478 - 1yx1LF

72479 - 1yx1LF

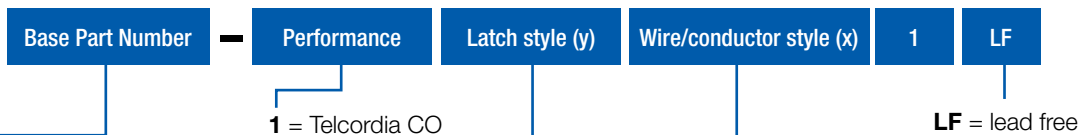

**72478** = 1 module, 5 x 6 pos.  
**72479** = 2 module, 5 x 12 pos.

**1** = standard finger latch  
for easiest actuation  
**2** = short finger latch  
for extra large cable

**1** = 26 to 24 AWG size  
**2** = 30 to 28 AWG size

## Cable connectors, shielded

### FEATURES

- Contact type Signal - Shielded
- Number of contacts (per row) 24
- Number of contacts (Total) 72
- Number of rows 3
- Orientation Straight
- Product Type Receptacle
- Termination Style IDC - Crimp
- Mating half 10022805-201LF
- Quantity 96
- Dimensional
- Size (Wire) AWG 26

### TECHNICAL DATA

#### PHYSICAL

- contact material: Phosphor bronze
- plating Telecom class Gold
  - plating (Contact area) 2 µm (79 µin.) Gold
  - plating Specification (Tail area) Telecom class Gold
- housing Material: Glass - Filled Thermoplastic Polyester
- performance level: Telcordia CO

#### ELECTRICAL

- current Rating: 1.0A per contact
- withstanding Voltage: 1000 rms
- insulation resistance: >1000 mega ohms after
- environmental exposure

#### MECHANICAL PERFORMANCE

- Insertion force (max per contact) 1.1N max. per contact
- withdrawal Force 0.15N min. per contact
- retention force 5N
- durability: 100 cycles (Telcordia)
- temperature: -55C to +105 C

#### ENVIRONMENTAL

- meets Telcordia Central Office and IEC Class 1 requirements. Additional platings are also available to meet uncontrolled environmental requirements; consult product drawings and product specifications for the cable connectors and mating headers.

#### PACKAGING

- bags

#### REFERENCE DATA

- Literature 950511-001
- product specification: GS-12-308
- Packaging specification: GS-14-008

#### APPLICATION EQUIPMENT

- for application equipment, check out the application equipment table on page 217-223

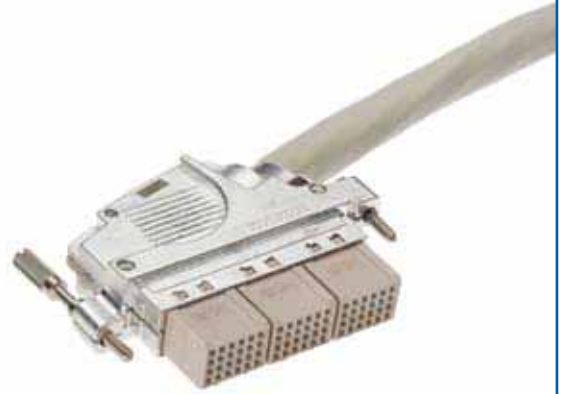

### MATING DATA

- mating part, page 200

- Mating half 10022805-101LF

## Cable connectors, shielded

### PRODUCT

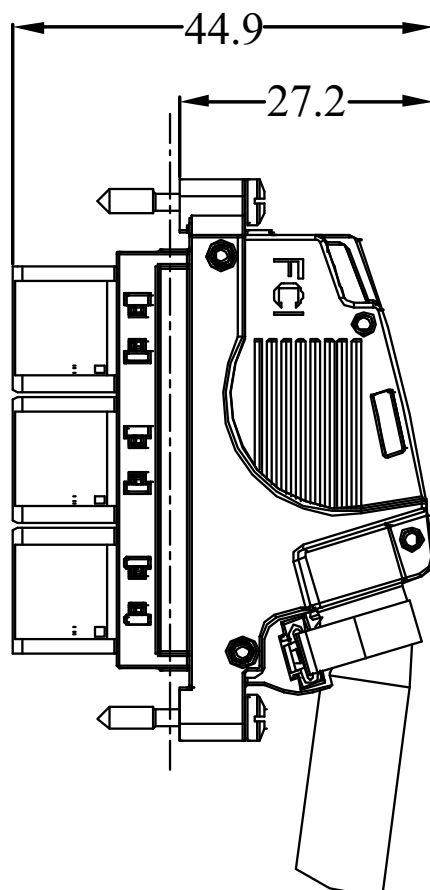
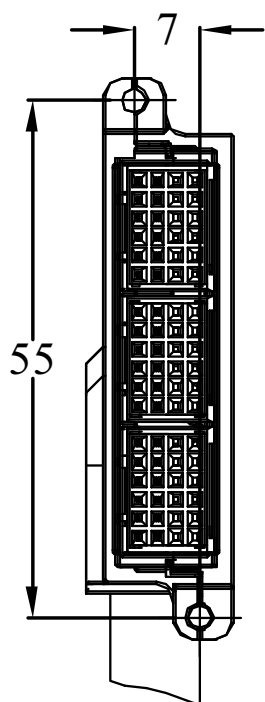

### PARTNUMBERS

**10013881 - 231LF**

= 72 position IDC cable connector







## METRAL® ACCESSORIES

- Coding Keys
- Guide Pin
- Ramping Module
- Shorting Clip
- End wall
- Hybrid housing

## Coding Keys

### FEATURES

- ▶ designed in accordance with IEC 61076-4-104
- ▶ User friendly system, easy application.
- ▶ No additional space required.
- ▶ Provides infinite number of coding possibilities for board to board connection.
- ▶ Extended keys for early engagement (for 5 row only).
- ▶ Standard coding, codes all METRAL connectors when mating length is not exceeding 6,5 mm.
- ▶ Extended keys codes from 5 up to 8 mm mating length.

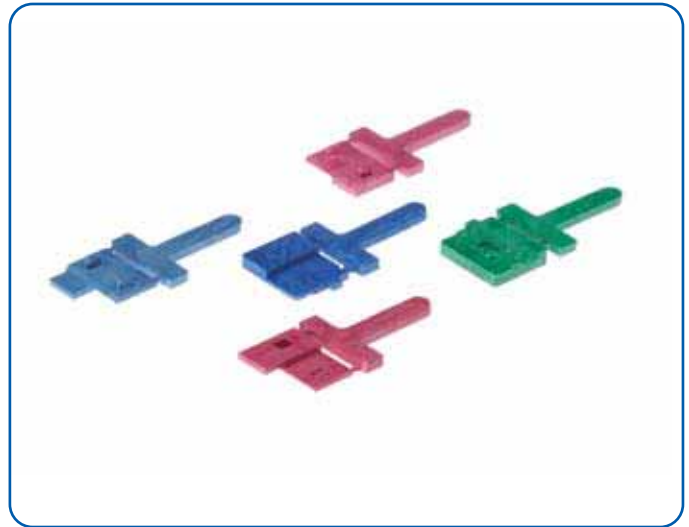

### TECHNICAL DATA

#### PHYSICAL

- ▶ Material: Glass - Filled Thermoplastic Polyester

#### MECHANICAL PERFORMANCE

- ▶ temperature: -55 °C to +125 °C

#### ENVIRONMENTAL

- ▶ RoHs information, this product is compatible according to the European Union Directive 2002/95/IEC

#### PACKAGING

- ▶ 100 parts, min. order quantity 100 parts

### TYPICAL APPLICATIONS

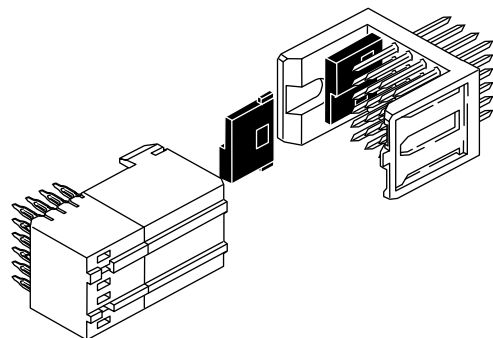

# Coding Keys

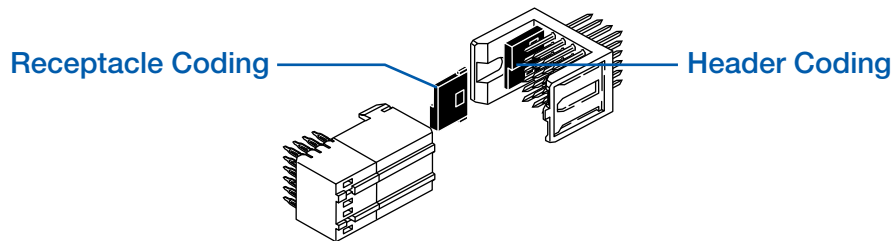

## PARTNUMBERS

Receptacle Coding			Header Coding	
mating pair	IEC standardized	Extended	IEC standardized	Extended
	 6,3 up to 6,5 mm pin length	 8,3 up to 8,0 mm pin length	 6,3 up to 6,5 mm pin length	 8,3 up to 8,0 mm pin length
Full			<b>Full Header Key</b>  90837-102LF green	<b>Full Header Key</b>  85811-101LF green
Full	<b>Full Receptacle Key</b>  91210-101LF green	<b>Full Receptacle Key</b>  85812-101LF green		
Left	<b>Left Receptacle Key</b>  91290-102LF pink	<b>Left Receptacle Key</b>  85814-102LF pink	<b>Right Header Key</b>  91289-102LF pink	<b>Right Header Key</b>  85813-102LF pink
Middle	<b>Middle Receptacle Key</b>  91290-103LF brown	<b>Middle Receptacle Key</b>  85814-103LF brown	<b>Middle Header Key</b>  91289-103LF brown	<b>Middle Header Key</b>  85813-103LF brown
Right	<b>Right Receptacle Key</b>  91290-101LF blue	<b>Right Receptacle Key</b>  85814-101LF blue	<b>Left Header Key</b>  91289-101LF blue	<b>Left Header Key</b>  85813-101LF blue

**Note:** blue marked part numbers are product selector parts

## Cable Connector Coding Keys

### FEATURES

- designed in accordance with IEC 61076-4-104
- User friendly system, easy application.
- No additional space required.
- Applicable for 4 and 5 row cable connectors.
- Provides 18 coding possibilities for cable to board connections.



### TECHNICAL DATA

#### PHYSICAL

- Material: Glass - Filled polyamide

#### MECHANICAL PERFORMANCE

- temperature: -55 °C to +125 °C

#### ENVIRONMENTAL

- RoHs information, this product is compatible according to the European Union Directive 2002/95/IEC

#### PACKAGING

- 100 parts, packed by bags

#### REFERENCE DATA

- Application Specifications: GS-20-002 (4 Row)  
GS-20-003 (5 Row)

### TYPICAL APPLICATIONS

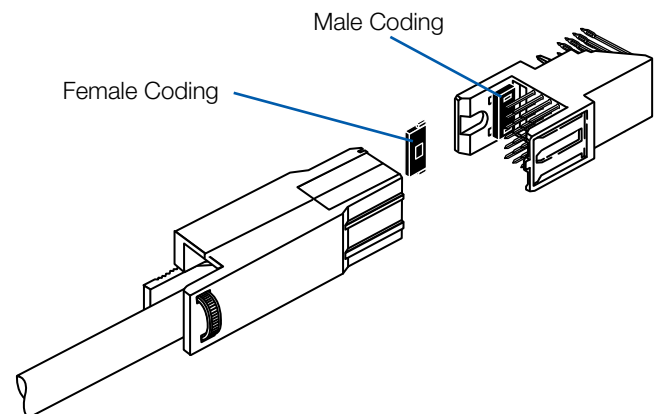

# Cable Connector Coding Keys

## PRODUCT

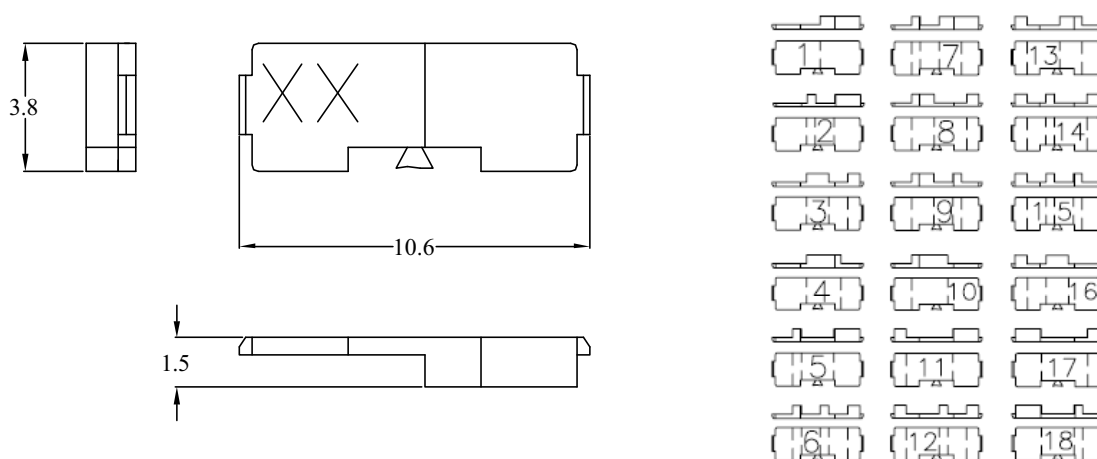

## PARTNUMBERS

72388 - yyyyLF

Base Part Number

Configuration

LF

72388 = Coding Key Cable connector

LF = lead free

yyyy	Key number
0011	1
0021	2
0031	3
0041	4
0051	5
0061	6
0071	7
0081	8
0091	9
0101	10
0111	11
0121	12
0131	13
0141	14
0151	15
0161	16
0171	17
0181	18

## Guide Pin

### FEATURES

- ▶ Early capture of daughter card.
- ▶ Stackable end-to-end without loss of position.
- ▶ Stackable with other METRAL function modules (e.g. signal, power, coax).
- ▶ Front and/or rear guiding.
- ▶ Plug polarization by design.

### TECHNICAL DATA

#### PHYSICAL

- ▶ Guide pin material: stainless steel

#### ENVIRONMENTAL

- ▶ RoHs information, this product is compatible according to the European Union Directive 2002/95/IEC

#### PACKAGING

- ▶ 100 parts, min. order quantity 100 parts

#### APPLICATION EQUIPMENT

- ▶ for application equipment, check out the application equipment table on page 217-223



### MATING DATA

#### ▶ mating part, page .....

- ▶ Receptacle housing: part no 70292-101LF, page 157
- ▶ Header housing, narrow body: part no 70290-101LF, page 155
- ▶ wide body: part no 88911-101LF, page 155

### TYPICAL APPLICATIONS

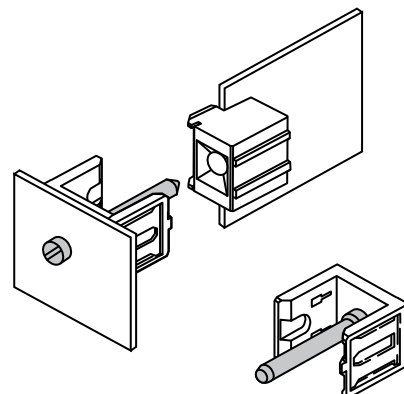

# Guide Pin

## PRODUCT

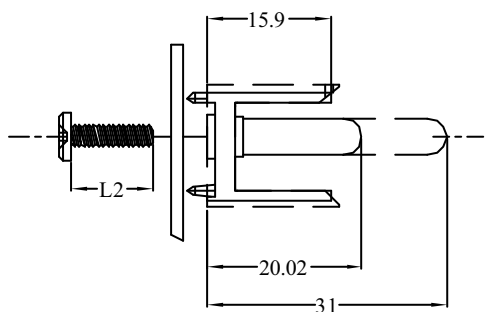

Single Guide Pin

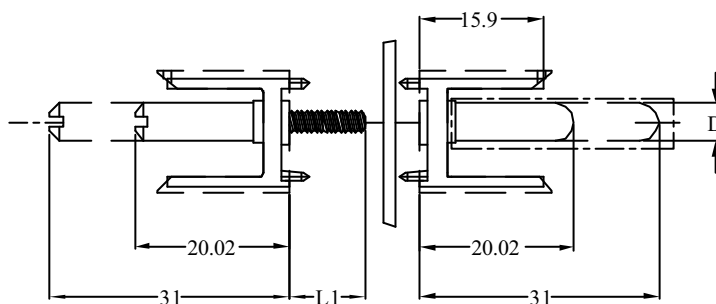

Double Guide Pin

PCB pattern P9, see chapter PCB layouts

## PARTNUMBERS

### Narrow Body Header Housing

Guide Pin Type		guide pin length	Part number Guide Pin	Required Header Housing	Required Receptacle Housing
single sided	short	20,0 mm	<b>70295-001LF</b>	(1x) 70290-101LF	(1x) 70292-101LF
	long	31,0 mm	<b>70295-002LF</b>	(1x) 70290-101LF	(1x) 70292-101LF
double sided	short	20,0 mm	<b>70295-003LF</b>	(2x) 70290-101LF	(2x) 70292-101LF
	long	31,0 mm	<b>70295-004LF</b>	(2x) 70290-101LF	(2x) 70292-101LF

### Wide Body Header Housing

Guide Pin Type		guide pin length	Part number Guide Pin	Required Header Housing	Required Receptacle Housing
single sided	short	20,0 mm	<b>70295-001LF</b>	(1x) 88911-101LF	(1x) 70292-101LF
	long	31,0 mm	<b>70295-002LF</b>	(1x) 88911-101LF	(1x) 70292-101LF
double sided	short	20,0 mm	<b>70295-003LF</b>	(2x) 88911-101LF	(2x) 70292-101LF
	long	31,0 mm	<b>70295-004LF</b>	(2x) 88911-101LF	(2x) 70292-101LF

**Note:** Housings not supplied with guide pins  
For details on housings see section Hybrid Headers and receptacles

## Board-to-Board Keying system

### FEATURES

- ▀ Daughter card keying
- ▀ Provides 20 keying combinations
- ▀ Modular design guarantees flexibility
- ▀ Stackable end-to-end without loss of position
- ▀ Engagement before 8.25 mm pins
- ▀ Precedes card latch engagement
- ▀ Receptacle available as 20 unique molded parts

### TECHNICAL DATA

#### PHYSICAL

- ▀ Keying pin material: stainless steel
- ▀ Housing material: Glass filled LCP,UL94V-0

#### ENVIRONMENTAL

- ▀ Operating temperature -55°C to +105°C
- ▀ RoHs information, this product is compatible according to the European Union Directive 2002/95/IEC

#### PACKAGING

- ▀ Receptacle housing: 50 housing/bag
- ▀ Keying pins with screws: 300 pins/bag

#### PROCESSING INFORMATION

- ▀ Wave, IR Vapor phase

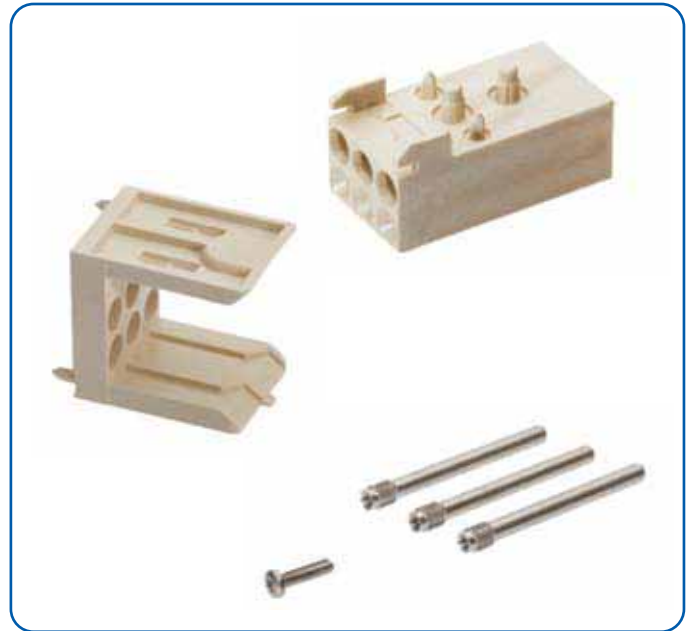

### MATING DATA

- ▀ Shroud, wide body 6 position, page 167
- ▀ part number 88913-101LF

### TYPICAL APPLICATIONS

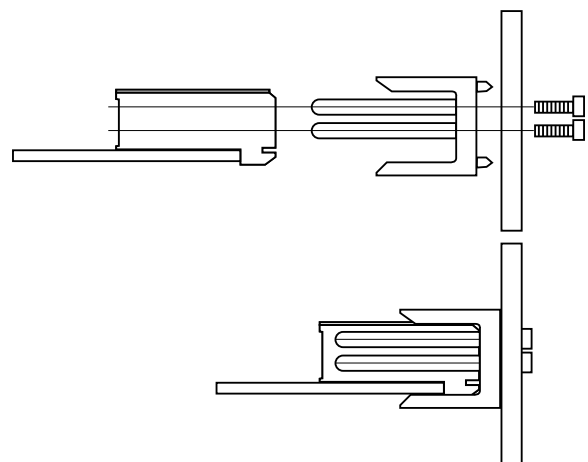



# Board-to-Board Keying system

## PRODUCT

Receptacle Keying module with press peg

Keying Pin

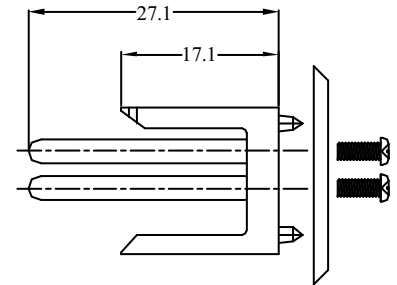
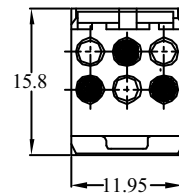
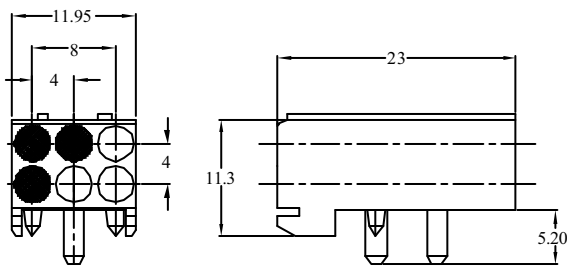

● = denotes plugged position

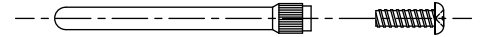
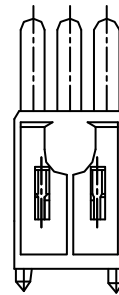
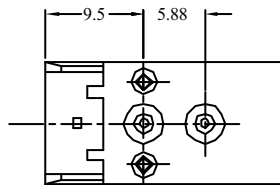

## PARTNUMBERS

Base Part Number

Pin Configuration

LF

LF = lead free

88914 - 0yyLF

Keying Pin

pin configuration	pcb thickness
011	2,31 - 3,10 mm
012	3,10 - 3,89 mm
013	3,89 - 4,67 mm

88916 - 2yyLF

Receptacle Keying module with press peg

pin configuration	201	202	203	204	205	206	207	208	209	210
		211	212	213	214	215	216	217	218	219

## Ramping Module

### FEATURES

- ▀ Provides initial vertical alignment on daughter card
- ▀ Symmetrical application; 2 required per slot
- ▀ Utilizes 6 mm of slot space
- ▀ Provides end-caps for backplane header slots
- ▀ Used independently of cabinet hardware design

### TECHNICAL DATA

#### PHYSICAL

- ▀ ramping module material, glass-filled nylon, color natural , UL94 V-0.

#### MECHANICAL PERFORMANCE

- ▀ temperature: -55C to +105 C

#### ENVIRONMENTAL

- ▀ RoHs information, this product is compatible according to the European Union Directive 2002/95/IEC

#### PACKAGING

- ▀ Bag of 500 pieces

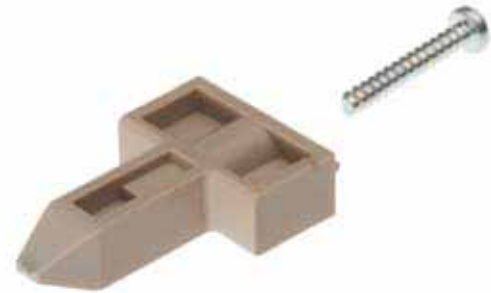

### MATING DATA

#### Used in combination with Header

- ▀ 4 row Header straight, solder-to-board, page 25
  - 1 mod, part number 88951-101LF
  - 2 mod, part number 88952-101LF
  - 4 mod, part number 88953-101LF
  - 8 mod, part number 88954-101LF
- ▀ 4 row Header straight, press-fit, page 27
  - 1 mod, part number 70232-116LF
  - 2 mod, part number 70233-116LF
  - 4 mod, part number 70234-116LF
  - 8 mod, part number 70235-116LF

### TYPICAL APPLICATIONS

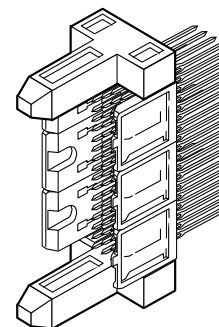

# Ramping Module

## PRODUCT

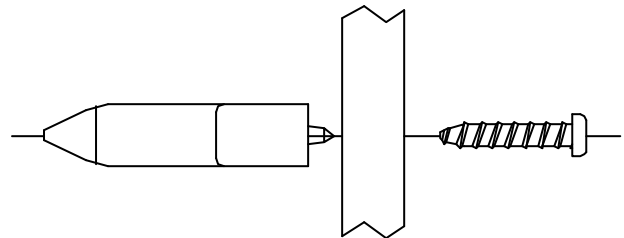
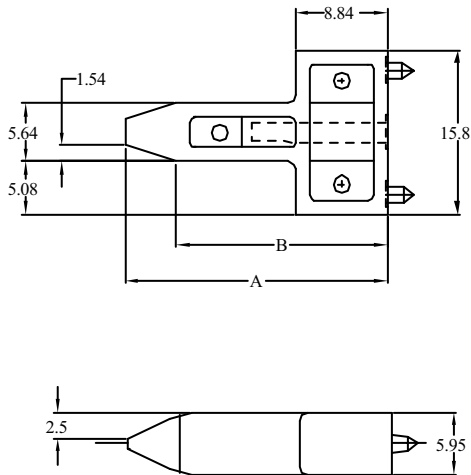

PCB pattern P19, see chapter PCB layouts

## PARTNUMBERS

88910 - yyyLF

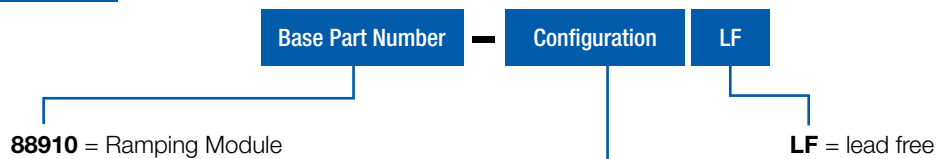

yyy	ramp height (dim. A)	ramp height (dim. B)
011	25,30	20,36
012	33,15	28,06

## Shorting Clip header, 4 row, signal, straight, press-fit, wide body

### FEATURES

- shorts any adjacent pin pair in row A of the Header signal pins mate before shorting clips break
- In accordance with IEC 60917 and IEC 61076-4-104 (Futurebus+)
- Eye of the needle press-fit contact

### TECHNICAL DATA

#### PHYSICAL

- spacing: 2,00 mm x 2,00 mm
- housing: glass-filled LCP, colour natural
- flammability rating: UL 94 V-0
- pin material: phosphor bronze
- performance level: Telcordia CO

#### ELECTRICAL

- current rating: 1 A
- insulation resistance:  $5 \times 10^3$  M $\Omega$  initially,  $1 \times 10^3$  M $\Omega$  after tests
- withstanding voltage: 1000 V rms (sea level)

#### MECHANICAL PERFORMANCE

- insertion force: 0,45 N max. per individual signal contact (mating)
- withdrawal force: 0,15 N max. per individual signal contact (unmating)
- press-fit contact insertion: 65 N max. per pin
- press-fit pin withdrawal: 15 N min. per pin
- recommended hole diameter: 0,65-0,80 mm

#### ENVIRONMENTAL

- Operating temperature range: -55°C to +125°C
- RoHs information, this product is compatible according to the European Union Directive 2002/95/IEC

#### PACKAGING

- standard: tubes

#### PROCESSING INFORMATION

- Applicable process: press-fit

#### REFERENCE DATA

- file no. GS-12-180
- application specification: BUS-20-073

#### APPLICATION EQUIPMENT

- for application equipment, check out the application equipment table on page 217-223



### MATING DATA

#### Receptacle, right angle, press-fit, page 35

- 1 mod – part number 88945-102LF
- 2 mod – part number 88946-102LF
- 4 mod – part number 88947-102LF
- 8 mod – part number 88948-102LF

#### Receptacle, right angle, solder-to-board, page 33

- 1 mod – part numbers 89035-101LF
- 2 mod – part numbers 89036-101LF
- 4 mod – part numbers 89037-101LF
- 8 mod – part numbers 89038-101LF

#### Receptacle, right angle, Pin-in-Paste, page 37

- 1 mod – part numbers 52048-101LF

### TYPICAL APPLICATIONS

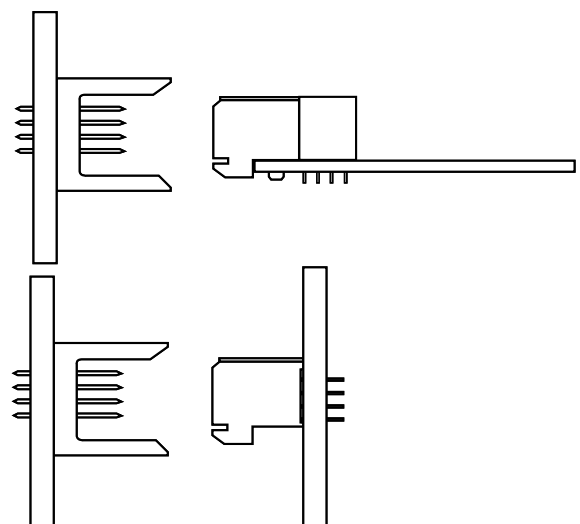

# Shorting Clip header, 4 row, signal, straight, press-fit, wide body

## PRODUCT

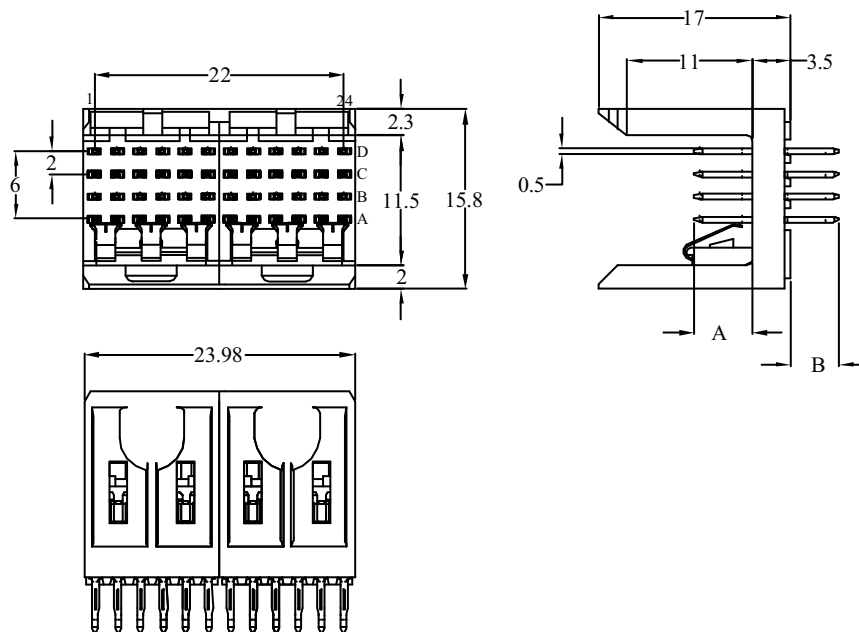

PCB pattern P6, see chapter PCB layouts

## PARTNUMBERS

**72013 - 1yyyLF**

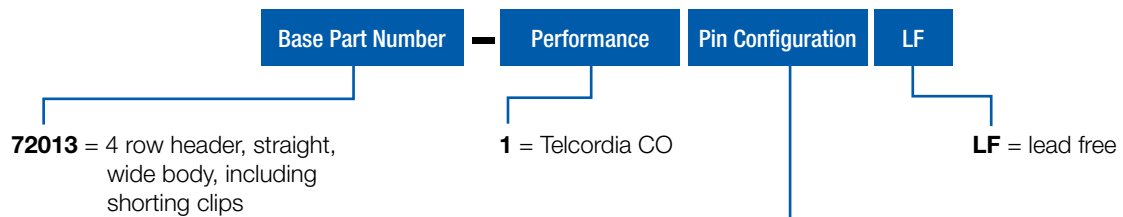

yyy	modules	no. of positions	mating length A	tail length B	shorting clip at
on request only	1	4 x 6	5,75 mm	4,30 mm	all row A pins
<b>003</b>	2	4 x 12	5,75 mm	4,30 mm	all row A pins
<b>004</b>	3	4 x 24	5,75 mm	4,30 mm	all row A pins
<b>005</b>	4	4 x 48	5,75 mm	4,30 mm	all row A pins

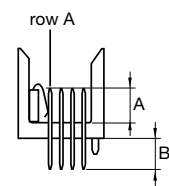

**Note:** for other special patterns or loadings, please check drawings, all other configurations on request only

# Shorting Clip header, 5 row, signal, straight, press-fit, wide body

## FEATURES

- shorts any adjacent pin pair in row A of the Header signal pins mate before shorting clips break
- In accordance with IEC 60917 and IEC 61076-4-104 (Futurebus+)
- Eye of the needle press-fit contact

## TECHNICAL DATA

### PHYSICAL

- spacing: 2,00 mm x 2,00 mm
- housing: glass-filled LCP, colour natural
- flammability rating: UL 94 V-0
- pin material: phosphor bronze
- performance level: Telcordia CO

### ELECTRICAL

- current rating: 1 A
- insulation resistance:  $5 \times 10^3 \text{ M}\Omega$  initially,  $1 \times 10^3 \text{ M}\Omega$  after tests
- withstanding voltage: 1000 V rms (sea level)

### MECHANICAL PERFORMANCE

- insertion force: 0,45 N max. per individual signal contact (mating)
- withdrawal force: 0,15 N max. per individual signal contact (unmating)
- press-fit contact insertion: 65 N max. per pin
- press-fit pin withdrawal: 15 N min. per pin
- recommended hole diameter: 0,65-0,80 mm

### ENVIRONMENTAL

- Operating temperature range:  $-55^\circ\text{C}$  to  $+125^\circ\text{C}$
- RoHs information, this product is compatible according to the European Union Directive 2002/95/IEC

### PACKAGING

- standard: tubes

### PROCESSING INFORMATION

- press fit

### REFERENCE DATA

- file no. GS-12-180
- application specification: BUS-20-073

### APPLICATION EQUIPMENT

- for application equipment, check out the application equipment table on page 217-223



## MATING DATA

### Receptacle, right angle, press-fit, pag 45

- 1 mod – part number 89047
- 2 mod – part number 89093
- 4 mod – part number 89094
- 8 mod – part number 89095

### Receptacle, right angle, solder-to-board, page 43

- 1 mod – part numbers 85863
- 2 mod – part numbers 85864
- 4 mod – part numbers 85865
- 8 mod - part numbers 85866

## TYPICAL APPLICATIONS

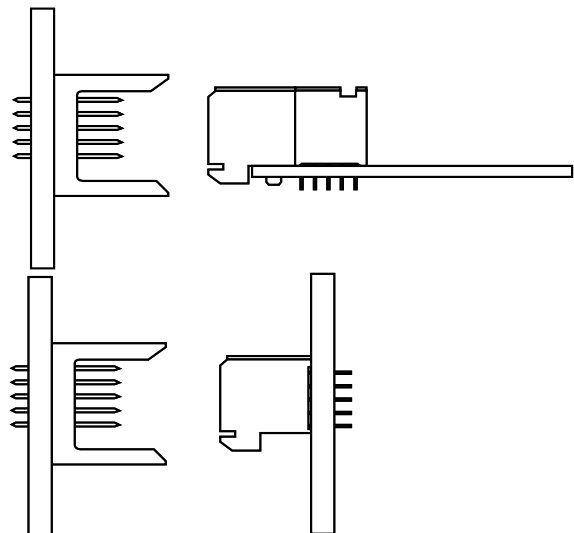

# Shorting Clip header, 5 row, signal, straight, press-fit, wide body

## PRODUCT

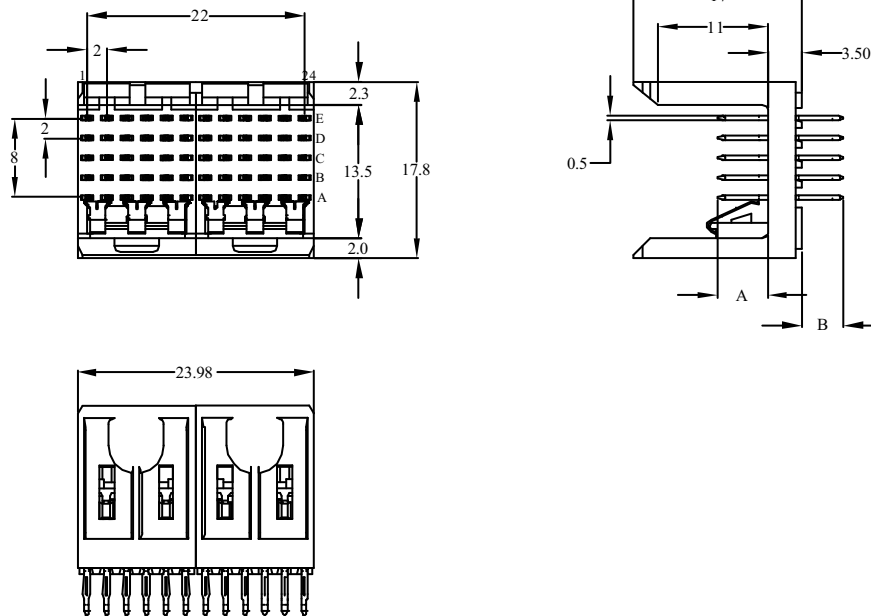

PCB pattern P7, see chapter PCB layouts

## PARTNUMBERS

72015 - 1yyyLF

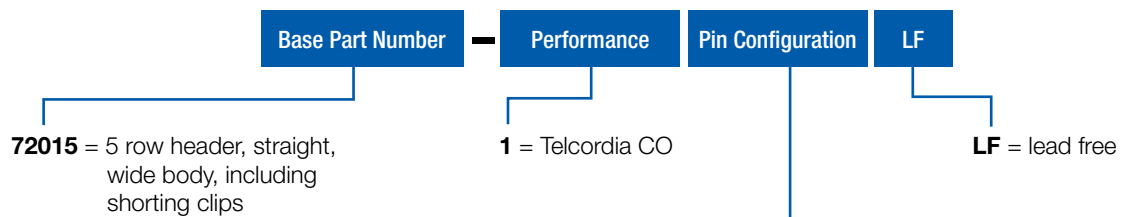

yyy	modules	no. of positions	mating length A	tail length B	shorting clip at
<b>003</b>	1	5 x 6	5,75 mm	4,30 mm	all row A pins
on request only	2	5 x 12	5,75 mm	4,30 mm	all row A pins
on request only	3	5 x 24	5,75 mm	4,30 mm	all row A pins
on request only	4	5 x 48	5,75 mm	4,30 mm	all row A pins

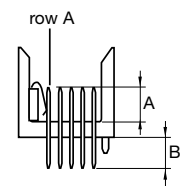

**Note:** for other special patterns or loadings, please check drawings, all other configurations on request only

## End wall

### FEATURES

- End wall can be used on either side of the Header
- Latch feature to prevent mismatch
- Protection feature
- Match with 4 row and 5 row shroud

### TECHNICAL DATA

#### PHYSICAL

- housing: 30% glass-filled flame retardant accessory, color natural, flammability rating: UL 94 V-0
- The housing withstand exposure to 260°C peak temperature for 15 seconds in a wave solder application with 1.5mm minimum PCB.

#### ENVIRONMENTAL

- RoHs information, this product is compatible according to the European Union Directive 2002/95/IEC

#### REFERENCE DATA

- Product specification GS-12-199



### MATING DATA

#### 4 row

- Shroud, part number 70203-xxxLF, page 83
- Hybrid header housing, part number 88911-xxxLF, page 155
- part number 88913-xxxLF, page 159

#### 5 row

- Shroud, part number 89055-xxxLF, page 85
- Header, part number 89006-116LF (1 mod), 89007-116LF (2 mod), 89008-116LF (4 mod) and 89009-116LF (8 mod), page 41

### TYPICAL APPLICATIONS

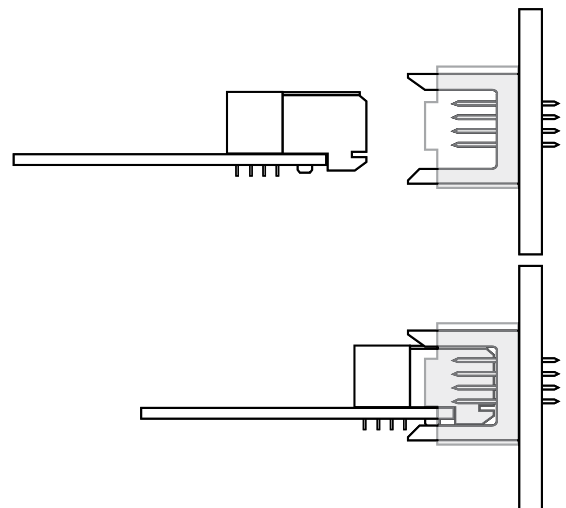



# End wall

## PRODUCT

### End Wall

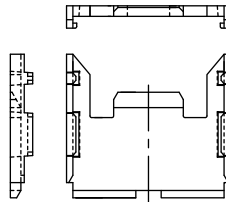

**73996-002**  
( 4 row application )

**73996-011**  
( 5 row application )

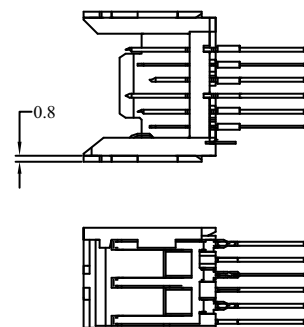
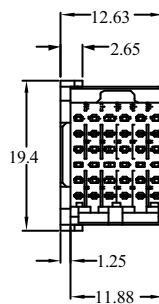
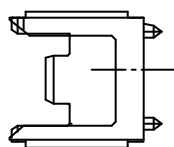
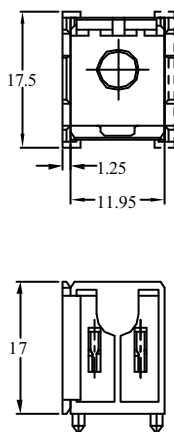

## PARTNUMBERS

73996 - yyyLF

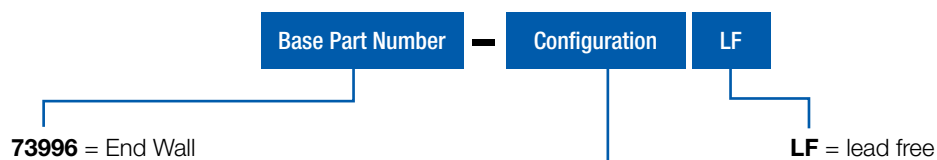

yyy	description
002	4 row Shroud & Hybrid housing
011	5 row Shroud & Header

## Hybrid housing

### FEATURES

- create stand off of 3,5 mm
- can be used for DIN standard power, coax and guide pin



### TECHNICAL DATA

#### PHYSICAL

- housing: glass-filled LCP, color natural
- flammability rating: UL 94 V-0
- temperature withstanding till 260C for 60 seconds

#### ENVIRONMENTAL

- RoHs information, this product is compatible according to the European Union Directive 2002/95/IEC

#### PROCESSING INFORMATION

- Infra-red or vapor phase reflow oven

#### RECOMMENDED HOLE DIAMETER

4 row Hybrid header housing in combination with	Hole diameter (unplated)
guide pin	3,25 mm +/-0,10 mm
screw to board high power insert	3,25 mm +/-0,10 mm
plug / plug high power coupler	6,00 mm +0,10 mm
receptacle / receptacle coax coupler	6,00 mm +0,10 mm

### MATING DATA

- Guide Pin, page 185
  - part number 70295-00XLF
- Screw to board high power insert, page 155
  - part number 91570-001LF
- Plug / plug high power coupler, page 155
  - part number 70201-001LF
- Receptacle / receptacle coax coupler, page 163
  - part number 70200-001LF

### TYPICAL APPLICATIONS

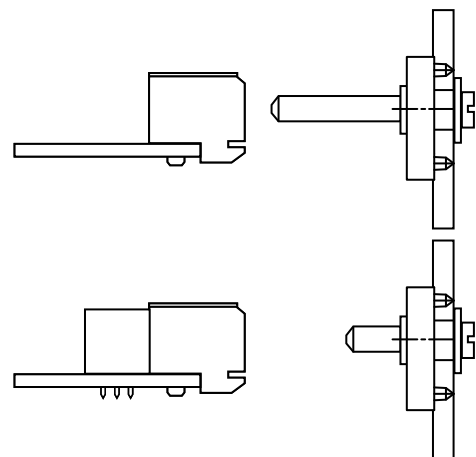

# Hybrid housing

## PRODUCT

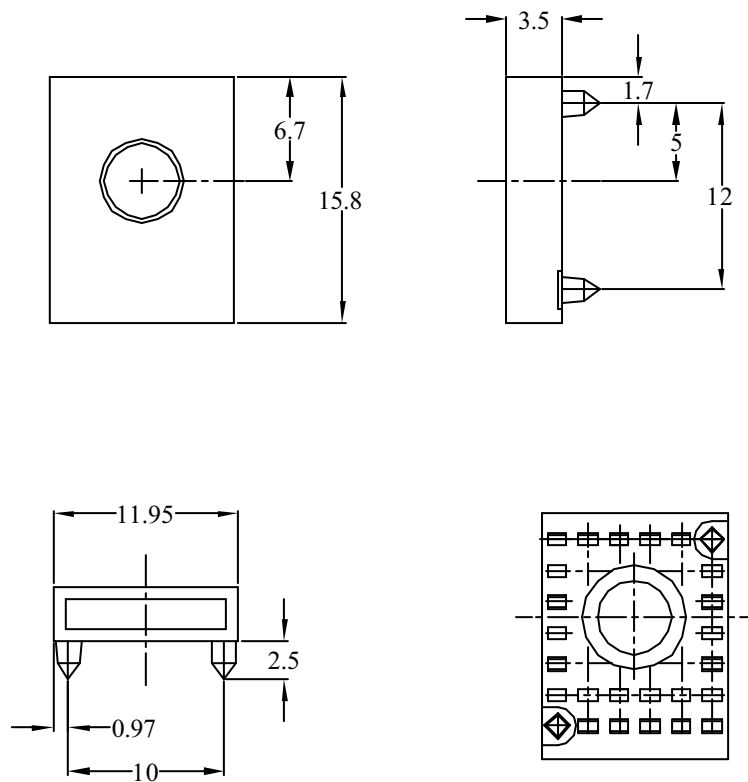

PCB pattern P25, see chapter PCB layouts

## PARTNUMBERS

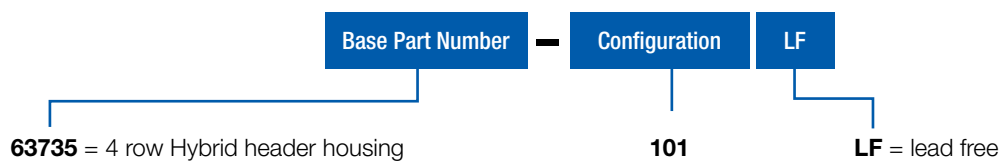

**63735 - 101LF**



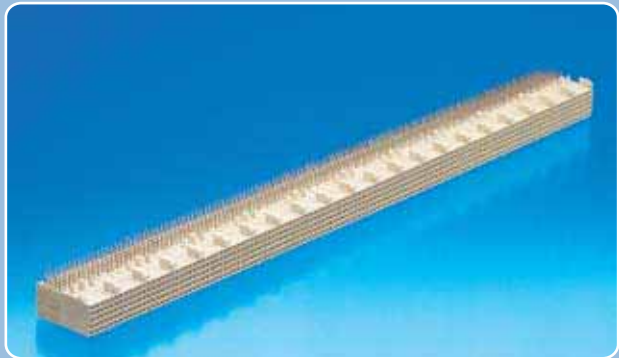



## METRAL® APPLICATION SPECIFIC

-  Mono blocks
-  Customized designs

The products shown give an impression of the capabilities within the METRAL® core family

8 module Signal & 2 module Power contact assembly with fixed modules

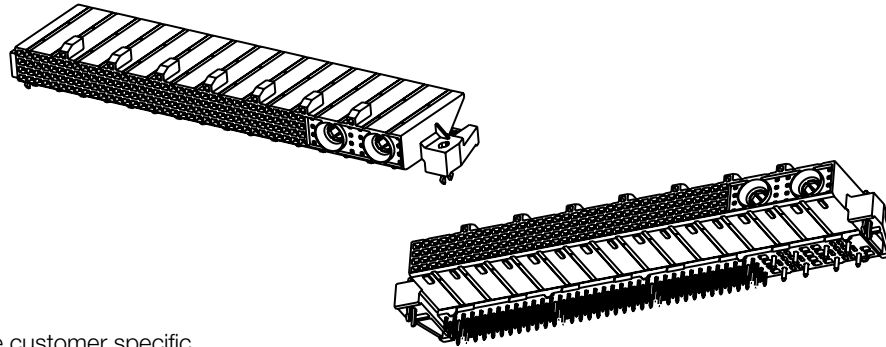

**Note:** all configurations are customer specific, new configurations on request only, please contact your local sales representative.

Signal Header right angle including Latch and Guiding

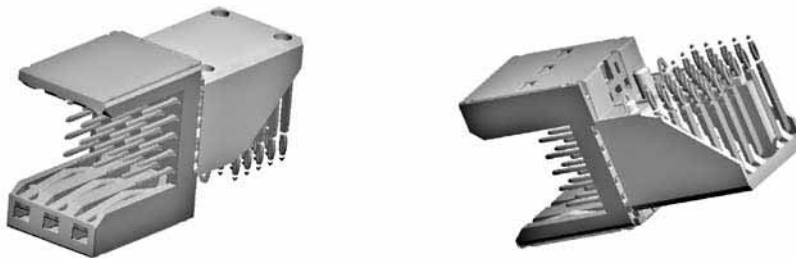

**PARTNUMBER** HM1B61LDP258H6PLF

Shielded Header 72 position (3 x 24 pos.) solder-to-board

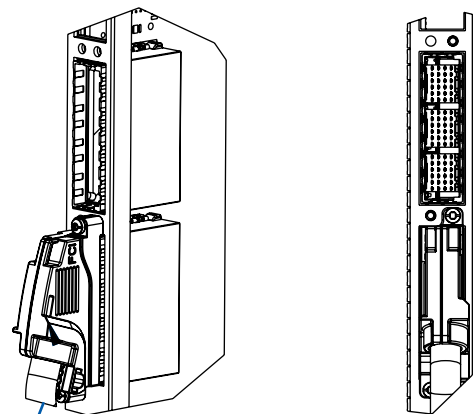
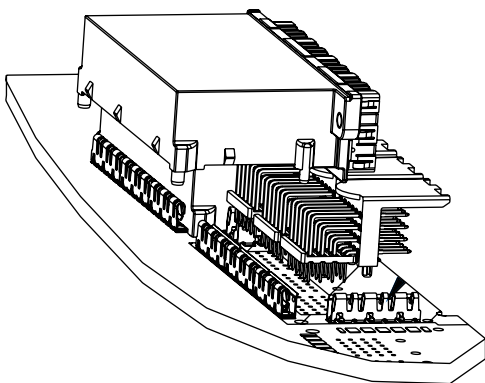

mating part, cable connector Shielded part number 10013381-231LF, page 177

**PARTNUMBER** 10022805-101LF

The products shown give an impression of the capabilities within the METRAL<sup>®</sup> core family

### Monoblocks, various Headers and Receptacles

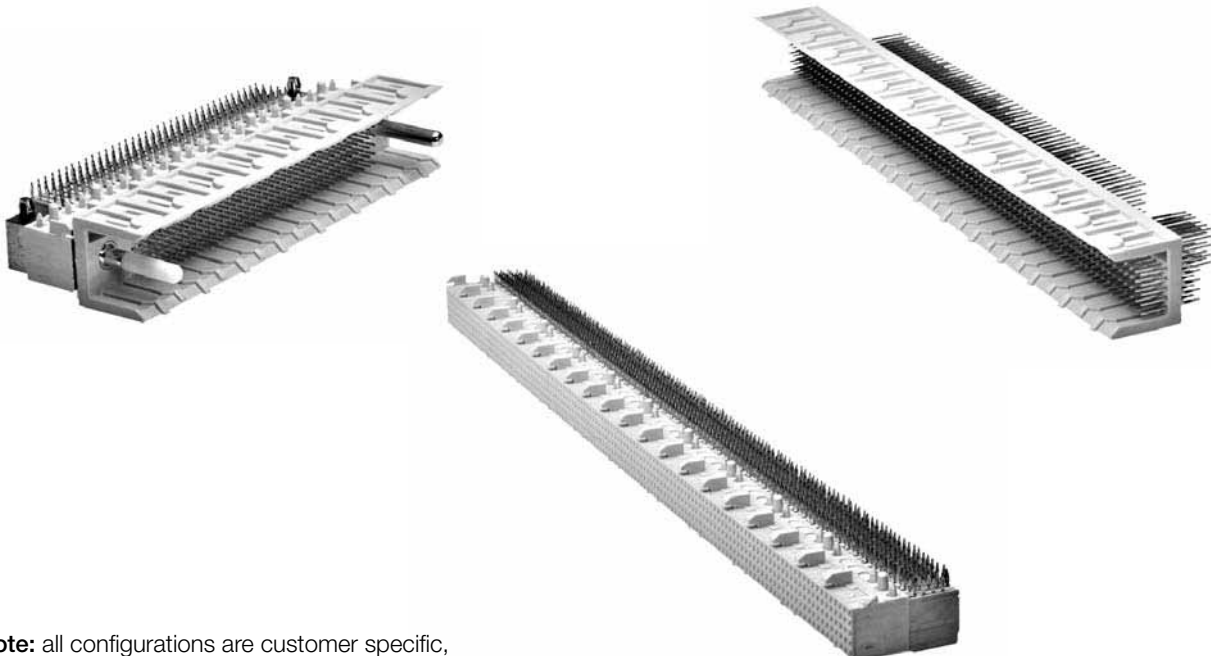

**Note:** all configurations are customer specific,  
new configurations on request only,  
please contact your local sales representative.

### E1-T1 Connectors, 2Mb Field I/O connector system

- 2 Mb - FieldIO - coax: Part number: 10001783-001LF
- 2 Mb - FieldIO - STP: Part number: 10007370-001LF
- Field Application tooling: BPY 506
- Product specification: GS-12-219
- Application specification: GS-20-032







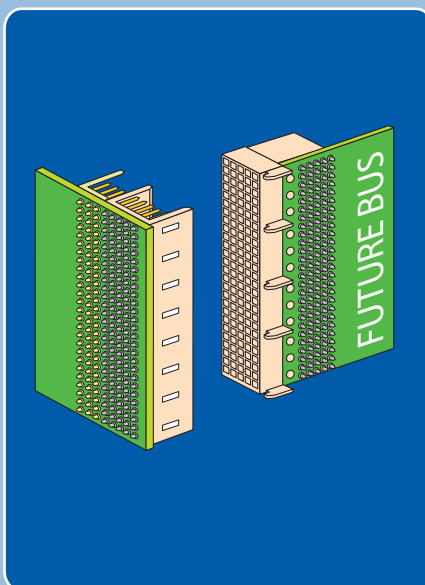





## METRAL® TECHNICAL SPECIFICATION

-  Future Bus
-  IPCI Bus
-  Performance Specifications
-  Electrical Specifications
-  Process Specifications

# METRAL® FUTUREBUS versus HARD METRIC

TECHNICAL SPECIFICATION

## FUTUREBUS

- ▶ METRAL® Core
- ▶ METRAL® High Speed

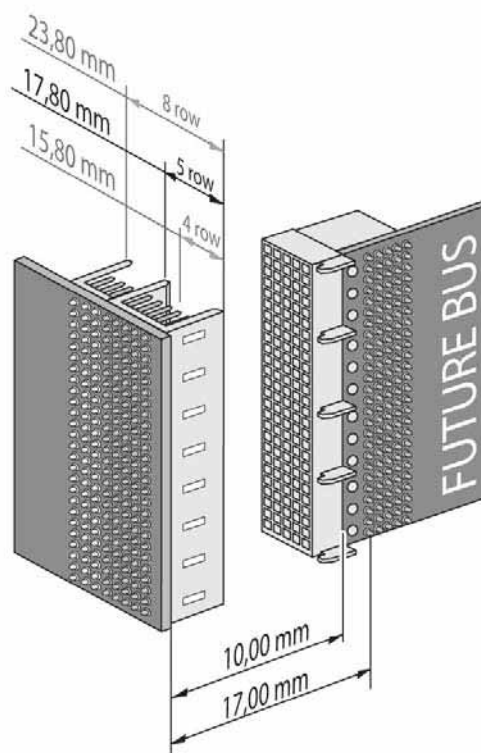

## HARD METRIC

- ▶ Millipacs
- ▶ Airmax

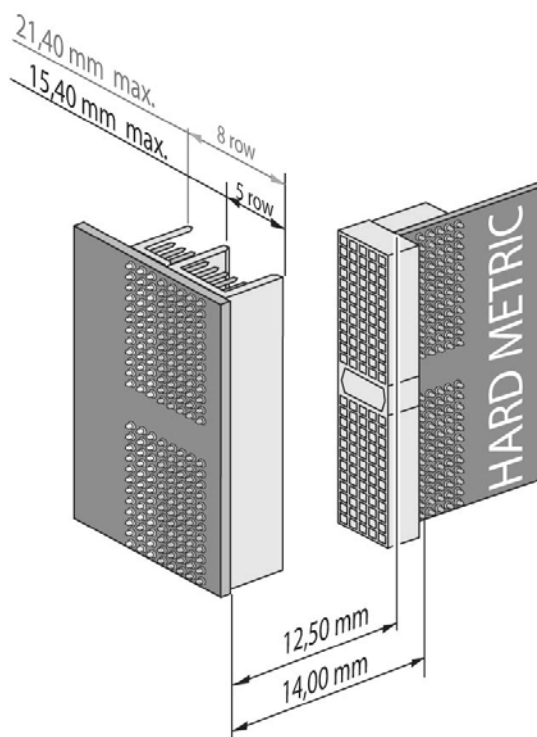

# METRAL® IPCI Bus

## FCI Electronics

METRAL® connector system was chosen as the interconnection system for the IPCI (Industrial peripheral computer Interface)

The following are typical 3SU and 6SU board configurations

### Daughter Board Receptacle Right-Angle

- Solder-to-Board  
5 x 48 positions  
85866-xxxLF
- Press-Fit  
5 x 48 positions  
89055-xxxLF

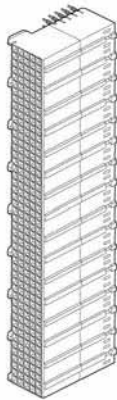

### Backpanel Header Straight

- Press-Fit  
5 x 48 positions  
89009-xxxLF

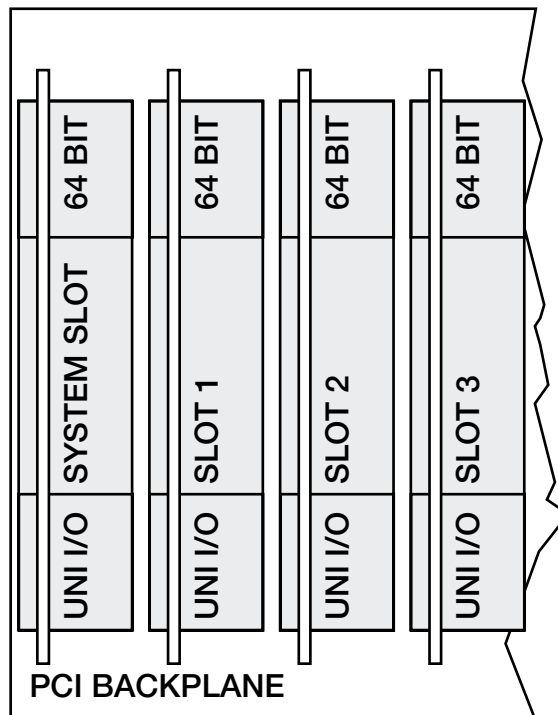
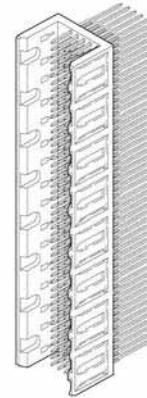

# ELECTRICAL CHARACTERISTICS

## GENERAL

- Although some of these parameters can be obtained from tabulated measured data, they are typically obtained from finite element or boundary element modeling type programs which model portions of the connector as separate transmission line sections. The resulting R, L, and C matrices are converted to SPICE parameters for each transmission line section. These parameters basically define lumped element approximations to each transmission line section. The METRAL® connector can be represented by three such transmission line sections; one for the leaded section, one for the internal block section, and one for the header section.
- The METRAL™ connector has been modeled by FCI Electronics, Ind. using Quantic Laboratories' two dimensional boundary element modeling program called Greenfield®.
- FCI Electronics has a number of SPICE models available.
- METRAL® 4 row 7 : 1 and 2 : 1 signal/ground ratio
- METRAL® 5 row 2 : 1 and 4 : 1 signal/ground ratio
- METRAL® 5 row row C grounded

Of course if needed, a specific SPICE model can be generated ( ask for details)

### Summary METRAL™ electrical data Standard

- All data :** With 2 : 1 signal to ground ratio  
Measurement system 50 Ohm impedance
- Capacitance**  
(1 mHz)  
(mated connector) 1 - 1,25 pF max.  
(location dependent)
- Inductance**  
500 ps risetime 12 - 18 nH  
1000 ps risetime 15 - 24 nH  
(location dependent)
- Propagation delay** 143 - 214 ps  
(24 ps. row to skew)
- Crosstalk** (single line driven)  
500 ps risetime 6,0 % max. near end  
1000 ps risetime 3,5 % max. near end
- Impedance**  
1000 ps risetime 56 - 71 Ohm  
(location dependent)
- Contact resistance**  
signal 25 - 45 m Ohm  
power 8 m Ohm
- Insulation resistance** > 5000 M Ohm

# ELECTRICAL CHARACTERISTICS

## GENERAL

### Current Carrying Capacity.

The current carrying capacity of a connector is that current which elevates the contact temperature to a specified value. It is a function of many variables including interconnection wiring (open wires and/or printed wiring), gauge and/or cross sections of wiring, board thicknesses, current in adjacent contacts, ambient temperature, and air flow.

Since actual application details may differ from these experimental conditions, the following results are provided only as an approximate guide for the current carrying capacity of the METRAL® Modular System. Current carrying capacity was measured for 10°C and 30°C rise above ambient.

The results are shown in Fig. 1.

The curves show cluster number (number of current carrying contacts surrounding the measured contact, including the measured contact) versus contact current.

The curves will asymptotically approach constant current at large clusters, but are approximately linear on the log-log scale over a cluster range of 1 to 25 in all cases.

Fig. 1 Current carrying capacity per contact for 10 °C and 30 °C temperature rise

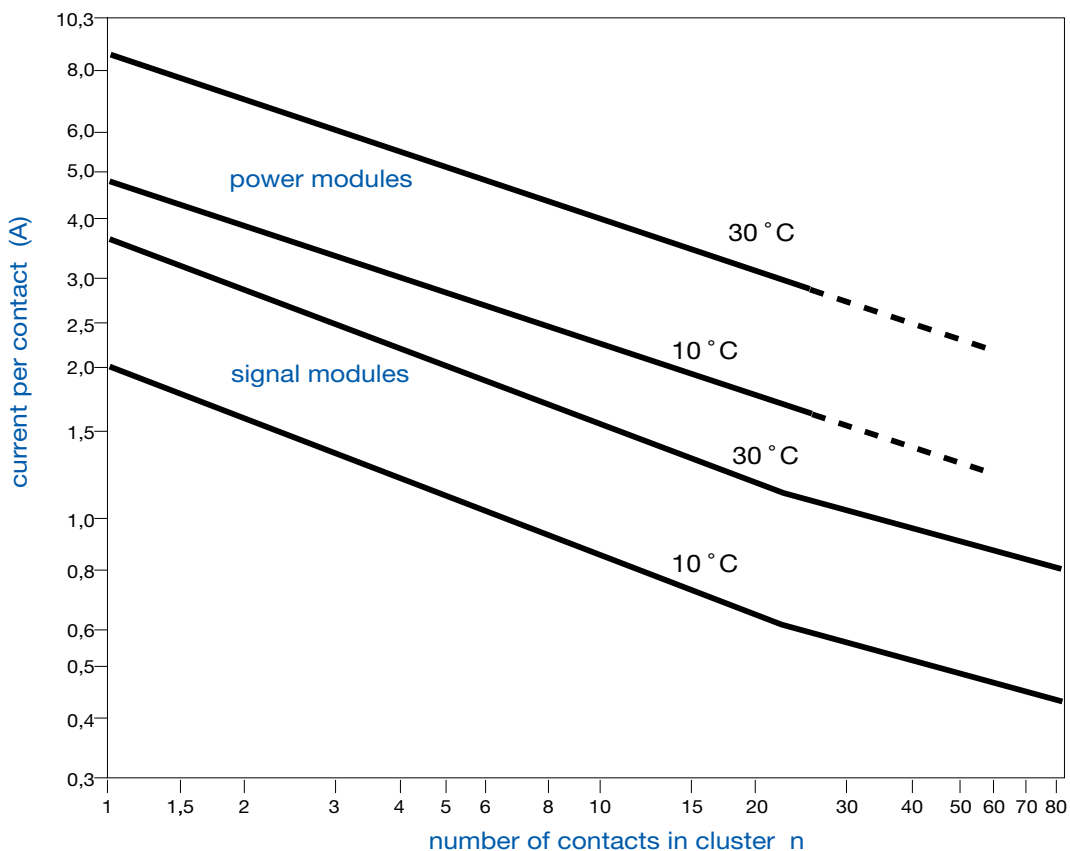

### SPICE Parameters.

Some users might prefer to use SPICE parameter representations of the connector to do their own network simulation response studies. These are R,L, and C parameters placed in SPICE parameter formats to be used by a SPICE program.

## Hole Specifications

<b>▶ Hole H1</b>	<ul style="list-style-type: none"> <li>• Drill size</li> <li>• Drilled hole tolerance</li> <li>• Copper plating</li> <li>• Tin-lead plating</li> <li>• Finished hole size</li> <li>• Recommended land size</li> </ul>	0,85 mm 0,81 to 0,86 mm 0,025 mm min 0,005 to 0,015 mm 0,65 to 0,80 mm 1,17 mm
<b>▶ Hole H2</b>	<ul style="list-style-type: none"> <li>• Unplated</li> <li>• Plated (for EE receptacle only)               <ul style="list-style-type: none"> <li>Drill size</li> <li>Copper plating</li> <li>Tin-lead plating</li> <li>Finished hole size</li> </ul> </li> </ul>	2,05 +0,05/-0,00 mm 2,10 mm 0,025 to 0,050 mm 0,005 to 0,015 mm 1,05 to 2,05 mm
<b>▶ Hole H3</b>	<ul style="list-style-type: none"> <li>• Unplated</li> </ul>	1,50 +0,10/-0,00 mm
<b>▶ Hole H4</b>	<ul style="list-style-type: none"> <li>• Unplated-when used with guide pin</li> <li>• Plated - when used with straight screw-to-board high-power plug insert; use pad 5,00 mm min. in dia</li> <li>• Plated - for press-fit power insert               <ul style="list-style-type: none"> <li>Drill size</li> <li>Copper plating</li> <li>Tin-lead plating</li> <li>Finished hole size</li> </ul> </li> </ul>	3,25 ±0,10 mm 3,25 ±0,10 mm 3,15 ±0,25 mm 0,04 mm min. 0,005 to 0,015 mm 3,00 +0,04/-0,06 mm
<b>▶ Hole H5</b>	<ul style="list-style-type: none"> <li>• Unplated</li> </ul>	6,00 +0,10/-0,00 mm
<b>▶ Hole H6</b>	<ul style="list-style-type: none"> <li>• Plated</li> <li>• When used with right-angle solder-to-board pass-through high-power receptacle insert, use common pad to tie all six holes together</li> <li>• When used with right-angle solder-to-board coax plug insert, surround each hole with pad 1,50 mm in dia.</li> </ul>	1,00 ±0,10 mm 1,00 ±0,10 mm
<b>▶ Hole H7</b>	<ul style="list-style-type: none"> <li>• Unplated</li> </ul>	2,80 +0,10/-0,00 mm
<b>▶ Hole H8</b>	<ul style="list-style-type: none"> <li>• Plated</li> <li>• Recommended land size</li> </ul>	0,70 +0,10/-0,05 mm 1,10 mm max
<b>▶ Hole H9</b>	<ul style="list-style-type: none"> <li>• Unplated</li> </ul>	1,85 ± 0,05 mm

# PCB Patterns

PCB Pattern	Family	Applicable to connector type	PCB recommended layout
<b>P1</b>	<b>Signal &amp; Power</b>	receptacle / header wide body / narrow body 4 row RIGHT ANGLE press-fit / solder-to-board / Pin-in-Paste (check P13 for Pin-in-Paste plating lay-out)	
<b>P2</b>	<b>Signal &amp; Power</b>	receptacle / header wide body / narrow body 5 row RIGHT ANGLE press-fit / solder-to-board / Pin-in-Paste (check P14 for Pin-in-Paste plating lay-out)	
<b>P3</b>	<b>Signal &amp; Power</b>	receptacle / header narrow body 4 row STRAIGHT solder-to-board	

# PCB Patterns

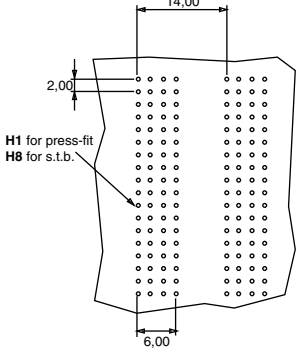
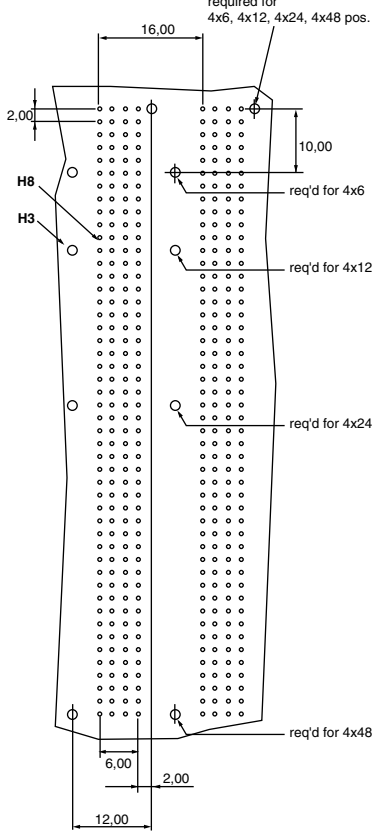
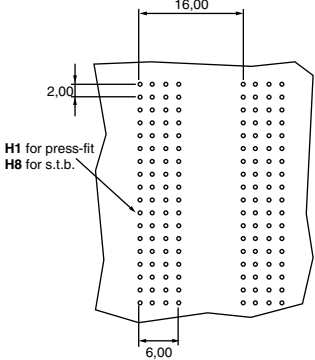
PCB Pattern	Family	Applicable to connector type	PCB recommended layout
<b>P4</b>	<b>Signal &amp; Power</b>	receptacle / header narrow body 4 row STRAIGHT press fit	
<b>P5</b>	<b>Signal &amp; Power</b>	receptacle / header wide body 4 row STRAIGHT solder to board	
<b>P6</b>	<b>Signal &amp; Power</b>	receptacle / header wide body 4 row STRAIGHT press fit	

PCB LAYOUTS



# PCB Patterns

PCB Pattern	Family	Applicable to connector type	PCB recommended layout
<b>P7</b>	<b>Signal &amp; Power</b>	receptacle / header wide body 5 row STRAIGHT press fit	<p>H1 for press-fit H8 for s.t.b.</p>
<b>P8</b>	<b>Hybrid</b>	DIN high power receptacle	<p>14,00 for narrow body</p>
<b>P9</b>	<b>Hybrid &amp; Accessories</b>	DIN high power header DIN standard Coax header Guide pin	<p>14,00 for narrow body 16,00 for wide body</p> <p>H4 guide pin H4 power press-fit H4 power screw-to-board H5 coax/power coupler</p> <p>needed for centerplane application only</p>
<b>P10</b>	<b>Hybrid</b>	DIN high power STRAIGHT receptacle DIN Standard RIGHT ANGLE receptacle	<p>for DIN power no central hole H6 for s.t.b.</p>

# PCB Patterns

PCB Pattern	Family	Applicable to connector type	PCB recommended layout
<b>P11</b>	<b>Hybrid</b>	MINI Coax receptacle	
<b>P12</b>	<b>Hybrid</b>	MINI power header MINI Coax header	
<b>P13</b>	<b>Signal</b>	plating lay-out receptacle 4 row Right Angle Pin-in-Paste	
<b>P14</b>	<b>Signal</b>	plating lay-out receptacle 5 row Right Angle Pin-in-Paste	

PCB LAYOUTS

# PCB Patterns

PCB Pattern	Family	Applicable to connector type	PCB recommended layout
<p><b>P15</b></p>	<p><b>Signal &amp; Power</b></p>	<p>receptacle / header wide body 5 row STRAIGHT press-fit Shielded</p>	
<p><b>P16</b></p>		<p>receptacle / header wide body 5 row STRAIGHT press-fit</p>	
<p><b>P17</b></p>	<p><b>Accessories</b></p>	<p>board-to-board keying receptacle</p>	

# PCB Patterns

PCB Pattern	Family	Applicable to connector type	PCB recommended layout
<b>P18</b>	<b>Accessories</b>	board-to-board keying pin	
<b>P19</b>	<b>Accessories</b>	ramping module	
<b>P20</b>	<b>Hybrid</b>	MINI power receptacle	
<b>P21</b>		header wide body 8 row STRAIGHT press-fit	

PCB LAYOUTS

# PCB Patterns

PCB Pattern	Family	Applicable to connector type	PCB recommended layout
<p><b>P22</b></p>	<p><b>Signal</b></p>	<p>receptacle wide body 8 row RIGHT ANGLE press-fit</p>	
<p><b>P23</b></p>	<p><b>High Power</b></p>	<p>High power header</p>	
<p><b>P24</b></p>	<p><b>High Power</b></p>	<p>High power receptacle</p>	
<p><b>P25</b></p>	<p><b>Accessories</b></p>	<p>Hybrid housing</p>	

PCB LAYOUTS



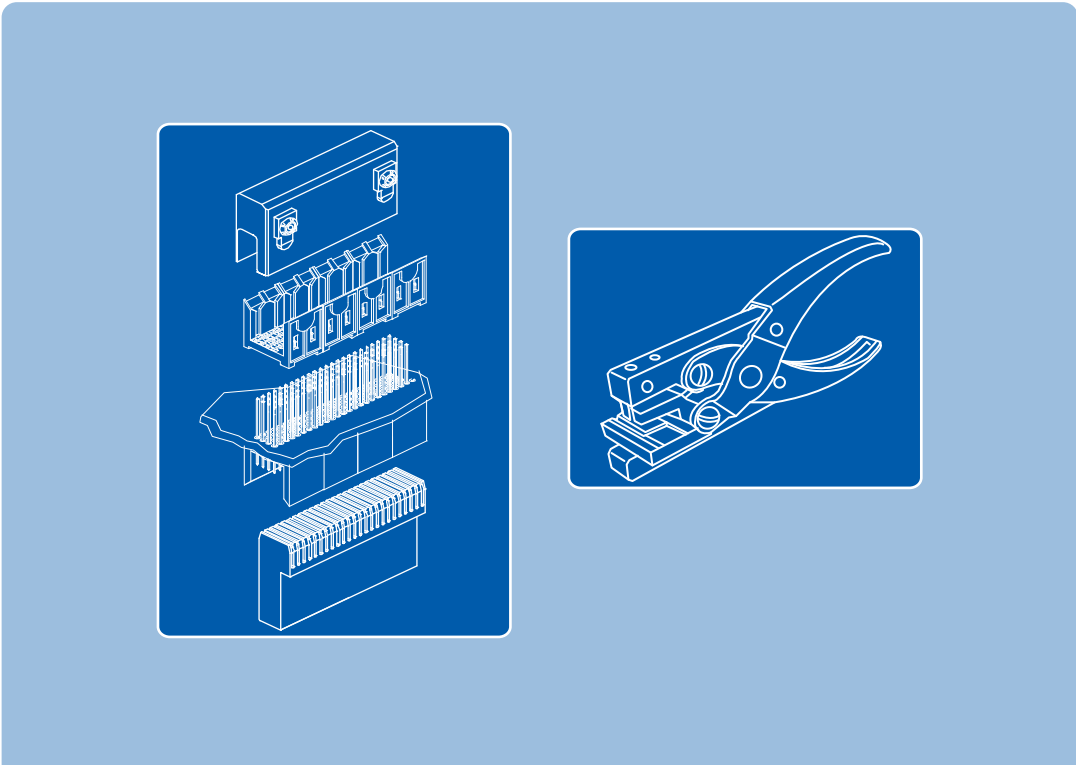

## METRAL® APPLICATION EQUIPMENT

 application tooling for the diverse connector types

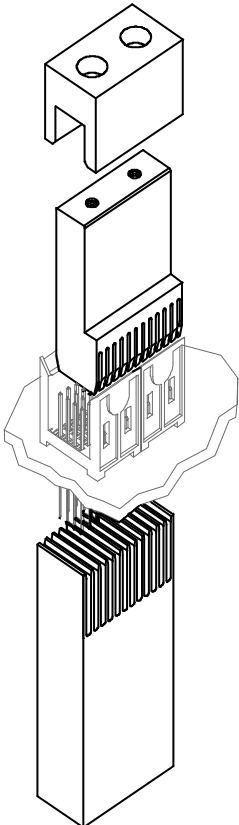
Family	Connector Type	Tooling Description	Tooling Part number	Tooling Application
<p><b>Signal, Power &amp; Electrical Enhanced</b></p>	<p><b>Header Straight</b></p>	<p><b>insertion tooling</b></p>		
		<p>press block holder - 4 and 5 row - 1 mod                      press block holder - 4 and 5 row - 2 mod                      press block holder - 4 and 5 row - 4 mod                      press block holder - 4 and 5 row - 8 mod</p>	<p>415446-001                      415446-002                      415446-003                      415446-004</p>	
		<p>board support - 4 and 5 row                      board support - 4 and 5 row                      board support - 4 and 5 row                      board support - 4 and 5 row</p>	<p>415609-001                      415609-002                      415609-003                      415609-004</p>	
		<p>signal press block - 4 row - 1 mod                      signal press block - 4 row - 2 mod                      signal press block - 4 row - 4 mod                      signal press block - 4 row - 8 mod</p>	<p>166934-001                      166934-002                      166934-003                      166934-004</p>	
		<p>signal press block - 5 row - 1 mod                      signal press block - 5 row - 2 mod                      signal press block - 5 row - 4 mod                      signal press block - 5 row - 8 mod</p>	<p>166935-001                      166935-002                      166935-003                      166935-004</p>	
		<p>power press block - 4 row - 1 mod                      power press block - 4 row - 2 mod                      power press block - 4 row - 4 mod                      power press block - 4 row - 8 mod</p>	<p>416393-001                      416393-002                      416393-003                      416393-004</p>	
		<p>power press block - 5 row - 1 mod                      power press block - 5 row - 2 mod                      power press block - 5 row - 4 mod                      power press block - 5 row - 8 mod</p>	<p>416394-001                      416394-002                      416394-003                      416394-004</p>	

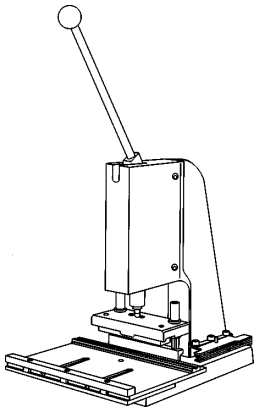
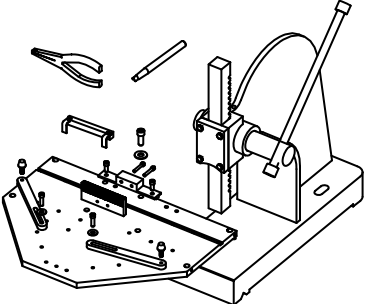
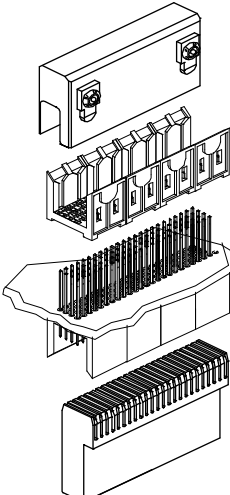
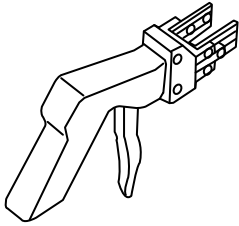

Family	Connector Type	Tooling Description	Tooling Part number	Tooling Application
Signal, Power & Electrical Enhanced	Header Straight	removal tool pin out of backside	MT-330 194208-001	
		removal tool pin out of matingside	MT-340 194204-001	
		self-repair KIT	MT-0370-01	
		multiple pin removal tool - 4 x 6 pos.  multiple pin removal tool - 5 x 6 pos.	HT-0531 415878-001  HT-0532 415878-002	

Family	Connector Type	Tooling Description	Tooling Part number	Tooling Application
<b>Signal, Power &amp; Electrical Enhanced</b>	<b>Receptacle Right angle</b>	<b>insertion tool - 4 and 5 row</b>  top tool press bar - 8 mod top tool press bar - 1 mod top tool press bar - 2 mod top tool press bar - 4 mod  board support bottom tool - 146.2mm	<b>MT-0510</b> 162452-001  162325-001 162325-004 162325-005 162325-007  162383-001	
		<b>removal tool - 4 and 5 row</b>  module blade - 1 mod module blade - 2 mod module blade - 4 mod module blade - 8 mod  module press bar module press bar module press bar module press bar	<b>HT-0518</b> 415774-001  413773-001 413776-001 413774-001 413775-001  415783-001 415783-002 415783-004 415783-008	
<b>Signal, Power</b>	<b>Shroud</b>	<b>insertion tool 4 row</b>  press block 2 mod - 4 row press block 4 mod - 4 row press block 8 mod - 4 row  <b>insertion tool 5 row</b> press block 2 mod - 5 row press block 4 mod - 5 row press block 8 mod - 5 row	166934 166623-003 166623-002 166623-001  166935 166624-003 166624-002 166624-001	
<b>Electrical Enhanced</b>	<b>Shroud</b>	<b>removal tool die-cast housing</b>	HT-0516 166816-001	

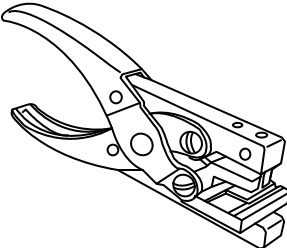
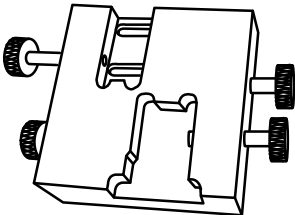
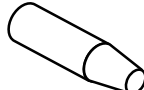
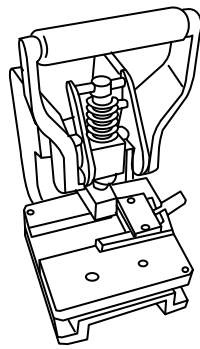
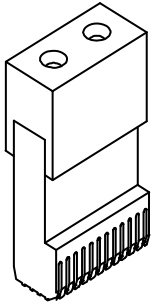
Family	Connector Type	Tooling Description	Tooling Part number	Tooling Application
Shielded Connectors	Round Cable Connector	insertion termination tool 4 row	HT-0524	
		insertion termination tool 5 row	HT-0525	
		removal termination tool 4 and 5 row	HT-0522	 
		removal termination tool contacts	HT-0523	
		cover assembly tool 4 and 5 row	HT-0520 415810-001	
	shielded cover assembly press	HT-0535 415860-001		
	Shielded Header & Shroud	insertion press block - 1 mod - 5 row insertion press block - 2 mod - 5 row insertion press block - 4 mod - 5 row insertion press block - 8 mod - 5 row  press block holder - 1 mod press block holder - 2 mod press block holder - 4 mod press block holder - 8 mod	416398-001 416398-002 416398-003 416398-004  415446-001 415446-002 415446-003 415446-004	

APPLICATION EQUIPMENT

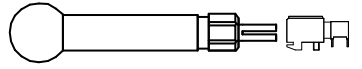
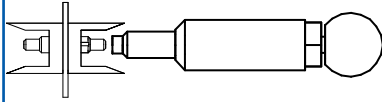
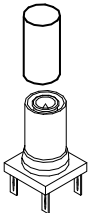
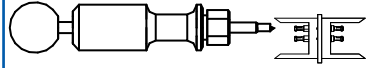
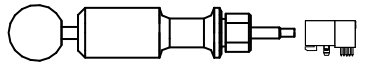
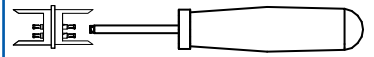
Family	Connector Type	Tooling Description	Tooling Part number	Tooling Application
Hybrid Connector	DIN Standard Coax	extraction tool receptacle housing	HT-0333	
		extraction tool receptacle header	194870	
	Hybrid Connector	insertion header coax contact	HT-0359	
		removal header coax contact	HT-0400	
		Mini Coax	insertion tool coax receptacle	415591-001
	extraction tool coax receptacle		HT-0410	
	removal tool housing		HT-358	

Family	Connector Type	Tooling Description	Tooling Part number	Tooling Application
Accessories	Guide Pin	guide pin insertion and removal tool	415995-001	
	Shorting Clip	insertion tooling - 4 row	409298-001	
insertion tooling - 5 row		409298-002		
Signal 8 row	Header Straight 8 row and Shroud 8 row	insertion tooling 2 mod (8 x 12pos.)  press block holder press block board support press block	415921-002 430073-001 416070-001 430073-002	
	Receptacle 8 row	insertion tooling 2 mod (8 x 12pos.)  Top tool press bar  board support bottom tool	416247-002  415970-002	

PART NUMBER	DESCRIPTION		PAGE
52048	4 row signal Receptacle right angle pin-in-paste	1 module	37
52049	5 row signal Receptacle right angle pin-in-paste	1 module	47
58361	4 row signal Header right angle pin-in-paste narrow body	1 module	65
58363	4 row signal Header right angle press-fit narrow body	1 module	63
63346	5 row power header straight solder-to-board wide body	1 module	105
63735	hybrid housing 4 row hybrid housing		197
63793	5 row power receptacle right angle pin-in-paste	1 module	113
70200	DIN coax receptacle coax insert		163
70201	DIN high power header power insert		155
70203	4 row shroud	1, 2, 4 and 8 module	83
70212	DIN coax receptacle coax insert		163
70232	4 row signal Header straight press-fit wide body	1 module	27
70233	4 row signal Header straight press-fit wide body	2 module	27
70234	4 row signal Header straight press-fit wide body	4 module	27
70235	4 row signal Header straight press-fit wide body	8 module	27
70236	4 row power header straight press-fit wide body	1 module	93
70239	MINI coax receptacle coax insert right angle		169
70243	MINI power header straight housing narrow body		159 / 167
70244	MINI power receptacle right angle housing		161 / 163 / 169
70264	4 row signal Header straight solder-to-board narrow body	1 module	29
70278	4 row power header straight solder-to-board narrow body	1 module	95
70290	DIN high power header housing narrow body		155
70292	guide pin receptacle housing		155 / 185
70295	guide pin guide pin		185
70424	DIN high power receptacle power insert / feed through		157
70437	5 row Electrical Enhanced header straight press-fit wide body shielded	1 module	135
70438	5 row Electrical Enhanced shroud wide body shielded	1 module	137
72013	4 row shorting clip		191
72015	5 row shorting clip		193
72031	5 row Shielded header straight press-fit	1 module	143
72096	DIN coax header coax insert straight		165
72388	cable connector coding key		183
72476	4 row Cable connector	4x6 pos	173
72477	4 row Cable connector	4x12 pos	173
72478	5 row Cable connector	5x6 pos	175
72479	5 row Cable connector	5x12 pos	175
72651	4 row power receptacle right angle pin-in-paste	1 module	103
73996	end wall end wall		195
74741	5 row signal Header straight solder-to-board wide body	1 module	39
74770	8 row signal Receptacle right angle press-fit	2 module	51
74771	8 row signal Header straight press-fit wide body	2 module	49
85706	5 row Shielded round cable connector		145
85757	4 row signal Receptacle straight press-fit	1 module	69
85758	4 row signal Receptacle straight press-fit	2 module	69
85759	4 row signal Receptacle straight press-fit	4 module	69
85760	4 row signal Receptacle straight press-fit	8 module	69
85761	5 row signal receptacle straight press-fit	1 module	79
85763	5 row signal receptacle straight press-fit	4 module	79
85811	coding key coding key header		181
85812	coding key coding key receptacle		181
85813	coding key coding key header		181
85814	coding key coding key receptacle		181
85822	4 row signal Header right angle solder-to-board narrow body	1 module	61
85826	4 row signal Header straight press-fit narrow body	1 module	31
85830	4 row power header straight press-fit narrow body	1 module	97
85847	5 row Electrical Enhanced receptacle right angle press-fit shielded	1 module	139
85863	5 row signal Receptacle right angle solder-to-board	1 module	43

PART NUMBER	DESCRIPTION		PAGE
85864	5 row signal Receptacle right angle solder-to-board	2 module	43
85865	5 row signal Receptacle right angle solder-to-board	4 module	43
85866	5 row signal Receptacle right angle solder-to-board	8 module	43
85876	5 row power receptacle right angle solder-to-board	1 module	109
85968	4 row power receptacle straight solder-to-board	1 module	123
85972	MINI power header mini power plug / coupler		159
85973	MINI power header straight mini power insert press-fit		159
85975	MINI power header right angle mini power insert		159
85976	MINI power receptacle right angle mini power insert		161
85995	DIN high power receptacle power insert		157
88910	ramping ramping module		189
88911	DIN high power header housing wide body		155 / 163
88913	MINI power header straight housing wide body		159 / 167
88914	board-to-board keying pin		187
88916	board-to-board keying receptacle module press-peg		187
88945	4 row signal Receptacle right angle press-fit	1 module	35
88946	4 row signal Receptacle right angle press-fit	2 module	35
88947	4 row signal Receptacle right angle press-fit	4 module	35
88948	4 row signal Receptacle right angle press-fit	8 module	35
88949	4 row power receptacle right angle press-fit	1 module	101
88951	4 row signal Header straight solder-to-board wide body	1 module	25
88952	4 row signal Header straight solder-to-board wide body	2 module	25
88953	4 row signal Header straight solder-to-board wide body	4 module	25
88954	4 row signal Header straight solder-to-board wide body	8 module	25
88960	4 row power header straight solder-to-board wide body	1 module	91
88971	MINI coax header straight coax plug/plug coupler		167
88977	DIN high power header power insert		155
88978	MINI coax header straight coax insert press-fit		167
88980	MINI coax header straight coax insert solder-to-board		167
88982	MINI power header right angle housing		159 / 167
88983	MINI coax header right angle coax insert solder-to-board		167
89006	5 row signal Header straight press-fit wide body	1 module	41
89007	5 row signal Header straight press-fit wide body	2 module	41
89008	5 row signal Header straight press-fit wide body	4 module	41
89009	5 row signal Header straight press-fit wide body	8 module	41
89035	4 row signal Receptacle right angle solder-to-board	1 module	33
89036	4 row signal Receptacle right angle solder-to-board	2 module	33
89037	4 row signal Receptacle right angle solder-to-board	4 module	33
89038	4 row signal Receptacle right angle solder-to-board	8 module	33
89039	4 row power receptacle right angle solder-to-board	1 module	99
89047	5 row signal Receptacle right angle press-fit	1 module	45
89055	5 row shroud	1, 2, 4 and 8 module	85
89092	DIN high power receptacle housing		157 / 165
89093	5 row signal Receptacle right angle press-fit	2 module	45
89094	5 row signal Receptacle right angle press-fit	4 module	45
89095	5 row signal Receptacle right angle press-fit	8 module	45
89096	5 row power receptacle right angle press-fit	1 module	111
89099	5 row power header straight press-fit wide body	1 module	107
90837	coding key coding key header		181
91210	coding key coding key receptacle		181
91289	coding key coding key header		181
91290	coding key coding key receptacle		181
91570	DIN high power header screw-to-board power insert		155
93903	DIN coax header coax insert straight		165
93904	DIN coax header coax insert straight		165
94561	5 row power receptacle straight solder-to-board	1 module	131
98173	8 row shroud	2 module	87

PART NUMBER	DESCRIPTION		PAGE
10009536	high power receptacle	2x1 pos	151
10009542	high power header	2x2 pos	149
10009556	high power header	2x1 pos	149
10013881	72 position shielded IDC cable connector	72 pos	177
10025058	high power receptacle	2x2 pos	151
HM1K41DAP000H6PLF	4 row power header right angle solder-to-board wide body	1 module	117
HM1K41DDP000H6PLF	4 row power header right angle press-fit wide body	1 module	119
HM1K41DFP000H6PLF	4 row power header right angle pin-in-paste wide body	1 module	121
HM1K51DAP000H6PLF	5 row power header right angle solder-to-board wide body	1 module	125
HM1K51DDP000H6PLF	5 row power header right angle press-fit wide body	1 module	127
HM1K51DFP000H6PLF	5 row power header right angle pin-in-paste wide body	1 module	129
HM1L41LAP000H6PLF	4 row signal Header right angle solder-to-board wide body	1 module	55
HM1L41LDP000H6PLF	4 row signal Header right angle press-fit wide body	1 module	57
HM1L41LFP000H6PLF	4 row signal Header right angle pin-in-paste wide body	1 module	59
HM1L42LAP000H6PLF	4 row signal Header right angle solder-to-board wide body	2 module	55
HM1L42LDP000H6PLF	4 row signal Header right angle press-fit wide body	2 module	57
HM1L43LAP000H6PLF	4 row signal Header right angle solder-to-board wide body	4 module	55
HM1L43LDP000H6PLF	4 row signal Header right angle press-fit wide body	4 module	57
HM1L44LAP000H6PLF	4 row signal Header right angle solder-to-board wide body	8 module	55
HM1L44LDP000H6PLF	4 row signal Header right angle press-fit wide body	8 module	57
HM1S51FRR000H6PLF	5 row signal receptacle straight solder-to-board	1 module	77
HM1L51LAP000H6PLF	5 row signal header right angle solder-to-board wide body	1 module	71
HM1L51LDP000H6PLF	5 row signal header right angle press-fit wide body	1 module	73
HM1L51LFP000H6PLF	5 row signal header right angle pin-in-paste wide body	1 module	75
HM1S52FRR000H6PLF	5 row signal receptacle straight solder-to-board	2 module	77
HM1L52LAP000H6PLF	5 row signal header right angle solder-to-board wide body	2 module	71
HM1L52LDP000H6PLF	5 row signal header right angle press-fit wide body	2 module	73
HM1S53FRR000H6PLF	5 row signal receptacle straight solder-to-board	4 module	77
HM1L53LAP000H6PLF	5 row signal header right angle solder-to-board wide body	4 module	71
HM1L53LDP000H6PLF	5 row signal header right angle press-fit wide body	4 module	73
HM1S54FRR000H6PLF	5 row signal receptacle straight solder-to-board	8 module	77
HM1L54LAP000H6PLF	5 row signal header right angle solder-to-board wide body	8 module	71
HM1L54LDP000H6PLF	5 row signal header right angle press-fit wide body	8 module	73
HM1S41FRR000H6PLF	4 row signal Receptacle straight solder-to-board	1 module	67
HM1S42FRR000H6PLF	4 row signal Receptacle straight solder-to-board	2 module	67
HM1S43FRR000H6PLF	4 row signal Receptacle straight solder-to-board	4 module	67
HM1S44FRR000H6PLF	4 row signal Receptacle straight solder-to-board	8 module	67



A large rectangular area with a blue border, containing 25 horizontal lines for writing notes.

For more information about e-catalog or FCI  
sales offices, headquarters, agents and local distributors,  
visit [www.fci.com](http://www.fci.com)



Americas - Phone: 1 (800) 237 2374 ■ Europe - - Phone: 33 1 39 49 21 83 ■ Asia/Pacific - Phone: 65 6549 6666

ELXMETRAL0108EA4E