

■ Connectivity...for
Business-Critical Continuity™

Video Broadcast *Product Catalog*



VIDEO BROADCAST

HDTV TRANSMISSION LINE NETWORK PRODUCT SOLUTIONS—ALL TRUE 75 OHM

HDTV digital technology has arrived in the television broadcast industry, bringing with it a new set of challenges. Among these are managing the risk, expense, and disruption of converting the in-station coax wireline network to HDTV technology. Yesterday's products simply don't support the increased bandwidth, frequency, and low error rate demands of the new era.

Today, broadcasters need more performance from the products they select and a higher standard of expertise from suppliers they partner with. At Trompeter, we are dedicated to meeting that challenge. We have focused our 35+ years of high frequency connection experience in the telecom, military communications, and aerospace industries to create a line of superior interconnects for HDTV applications.

The new line of digital interconnect solutions outlined in this brochure was designed to be easy to understand, easy to buy, and pre-configured for success. It includes fully loaded video jack fields, 75 ohm connectors, distribution panels, tools and training packages. Each product element is configured with flexibility to accommodate the unique requirements of your station, and each component meets or exceeds the SMPTE 292M specification for full bandwidth uncompressed signal transport at 1.485 Gbps data rates.

Please contact us directly if you have special needs or questions. An applications engineer will be happy to work with you to explain our products or create a special solution for your station conversion. You are invited to visit our updated website (www.trompeter.com) for product information, technical articles and online quotations/ordering.

Our goal at Trompeter is to deliver the best available product solutions and the highest level of service to make your move to digital successful.

Trompeter Electronics is an ISO 9001 registered company.



TABLE OF CONTENTS

VIDEO PATCHING

HDTV Video Patch Jacks	2-6
Video Monitor Probe	7
75 ohm WECo Patching	13-14
75 ohm Mini-WECo Patching	15
Cable Assembly	16
Precision Load Termination	23

VIDEO PANELS

Panel Configurations	8-11
Component Video	12

STEALTH BNC

UPL2000 Series	18-22
UPL2000 Cable Groups	22

F CONNECTORS

BNC to Male F Adapter	24
1-Piece F Connector	25
3-Piece F Connector	26
PCB Edge Mount F	27

INSTALLATION TOOLS

Cable Strippers	29
Crimp Tools	30
Bench Top Crimp Tool	31
BNC Assembly Tester	31
Removal Tools	31

HDTV GLOSSARY

Broadcast Terms	32-34
-----------------	-------

DIALOG BOX

BROADCAST TELEVISION DATA RATES

	Vertical Lines	Horizontal Lines	Data Rate in Gbps
NTSC	525	487	-0-
SDTV	480	640	.270
DTV-W	480	704	.270
HDTV	1080	1920	1.485



HDTV HIGH FREQUENCY MINI-WECO VIDEO PATCHING

HDTV TRANSMISSION LINE NETWORK PRODUCT SOLUTIONS—ALL TRUE 75 OHM

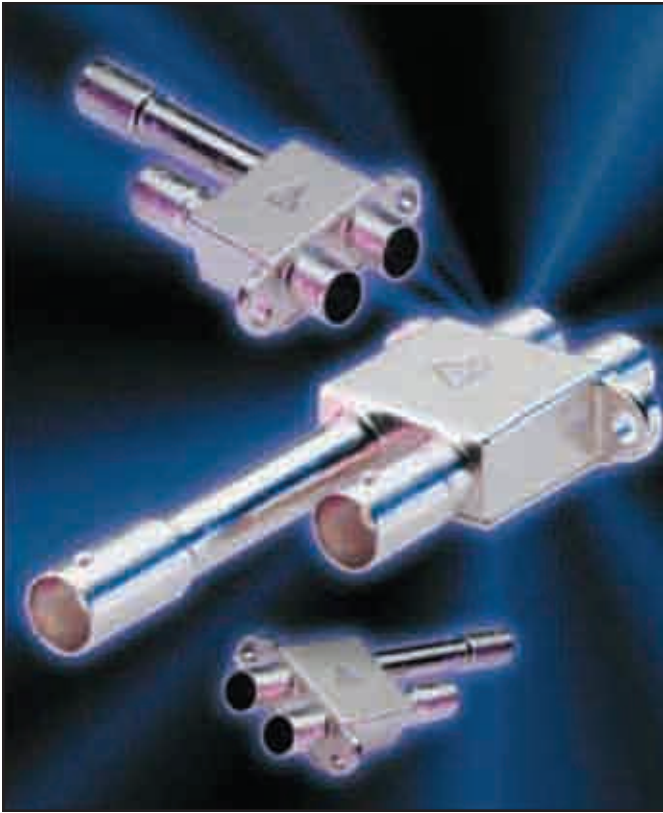

The **HDVDPM** is a low profile jack designed for HDTV digital applications where space allocation is critical (see Application Notes below). Smaller and with a lower profile than the standard WECO jacks, the HDVDPM allows for 128 ports in the same rack space as 48 standard jacks, a density improvement of 33% more patching.

This miniature high frequency dual coaxial normal-thru digital patch jack establishes a benchmark for superior mechanical design, wideband performance, dependability and reliability at a highly competitive price.

The HDVDPM jack incorporates an innovative and unique normal-thru contact interface that delivers superior mechanical reliability. As a result, typical normal-thru failures are eliminated. In addition, the HDVDPM is designed to meet both the time domain and frequency domain requirements mandated by SMPTE for HDTV transmission.

The Trompeter jack is designed lighter and uses fewer moving parts than other designs. The HDVDPM weighs slightly over 34 grams compared to similar competitive products weighing 81 grams on average—a weight savings of 57%. The design provides self-wiping action upon plug insertion, a proven approach for circular plug applications, eliminating the need for heavy and complex dust control plungers and multiple actuators common to other designs.

Precision construction, use of the finest materials, true impedance-matched components, and outstanding RF performance make this product a benchmark for reliability and value.

APPLICATION NOTE:

This mini-WECO patch jack is ideal for mobile video news vans, high-density in-station patching, remote site trucks, uplink/downlink stations, and cable head-ends when higher frequency, high density applications for HDTV video signals are used.

Smaller and with a lower profile than the standard WECO jack, the HDVDPM enables up to 32 jacks in a 1-RU high panel.

FEATURE

BENEFIT

Heat-treated beryllium copper actuator, outer contact and center socket contacts	Long life, low contact resistance and consistent forces
50 millionths of an inch gold plating on center socket contacts	Excellent contact resistance over time
Dielectrics are made of Teflon™	Superior dielectric properties. Superior heat and chemical resistance.
Self-wiping normalizing switch	Positive, reliable electrical contact over time.
Low profile rugged die cast body	Long life normal-thru and terminating contacts in a light-weight package

HDTV HIGH FREQUENCY MINI-WECO VIDEO PATCHING

HDTV TRANSMISSION LINE NETWORK PRODUCT SOLUTIONS—ALL TRUE 75 OHM

75 Ohm High Frequency Dual Coaxial
Normal-Thru Mini-WECO Patch Jack

Un-Terminated **HDVDPM**
Terminated **HDVDPMT**

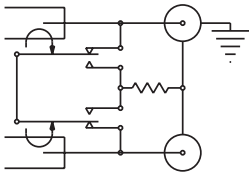
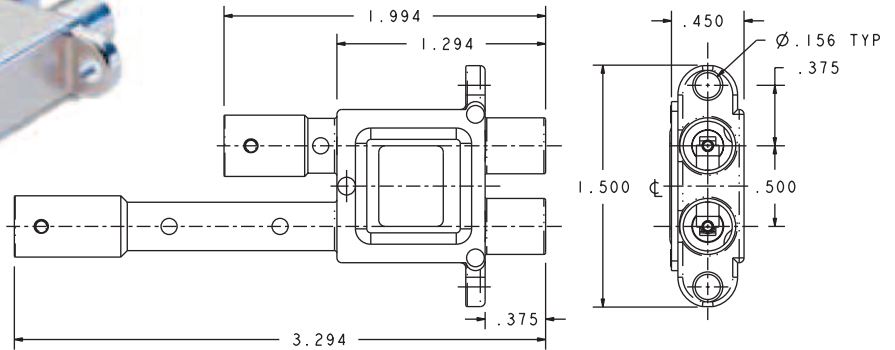

HDVDPMT (Self-terminating)

Inserting a plug into the source side automatically terminates the load side. Insertion into the load side automatically terminates the source side. Either provides a resistive load to the unused side.

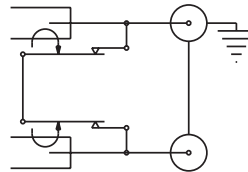

HDVDPM (Non-terminated)

Inserting a plug into either side breaks the normalthrough. Normal-thru is BNC to BNC.

Electrical Data

Characteristic Impedance	75 ohms nominal
Return Loss	Meets or exceeds the requirements of the following: SMPTE 292: S1, 1 < 15db from 5MHz to 1.485GHz SMPTE 424: S1, 1 < 15dB from 5MHz to 1.485 GHz, S1, 1 <10dB from 1,485GHz to 3GHz
Time Domain Requirements	Meets or exceeds SMPTE 292 & 424
Termination Resistor	75 ohms

Mechanical Data

Weight	34.2 grams
--------	------------

Material Data

Connector Housing	Zinc alloy, NI plated
Actuator and Center Conductors	Beryllium copper
Connector Dielectrics	PTFE



HDTV-READY HIGH FREQUENCY VIDEO JACKS

HDTV TRANSMISSION LINE NETWORK PRODUCT SOLUTIONS—ALL TRUE 75 OHM

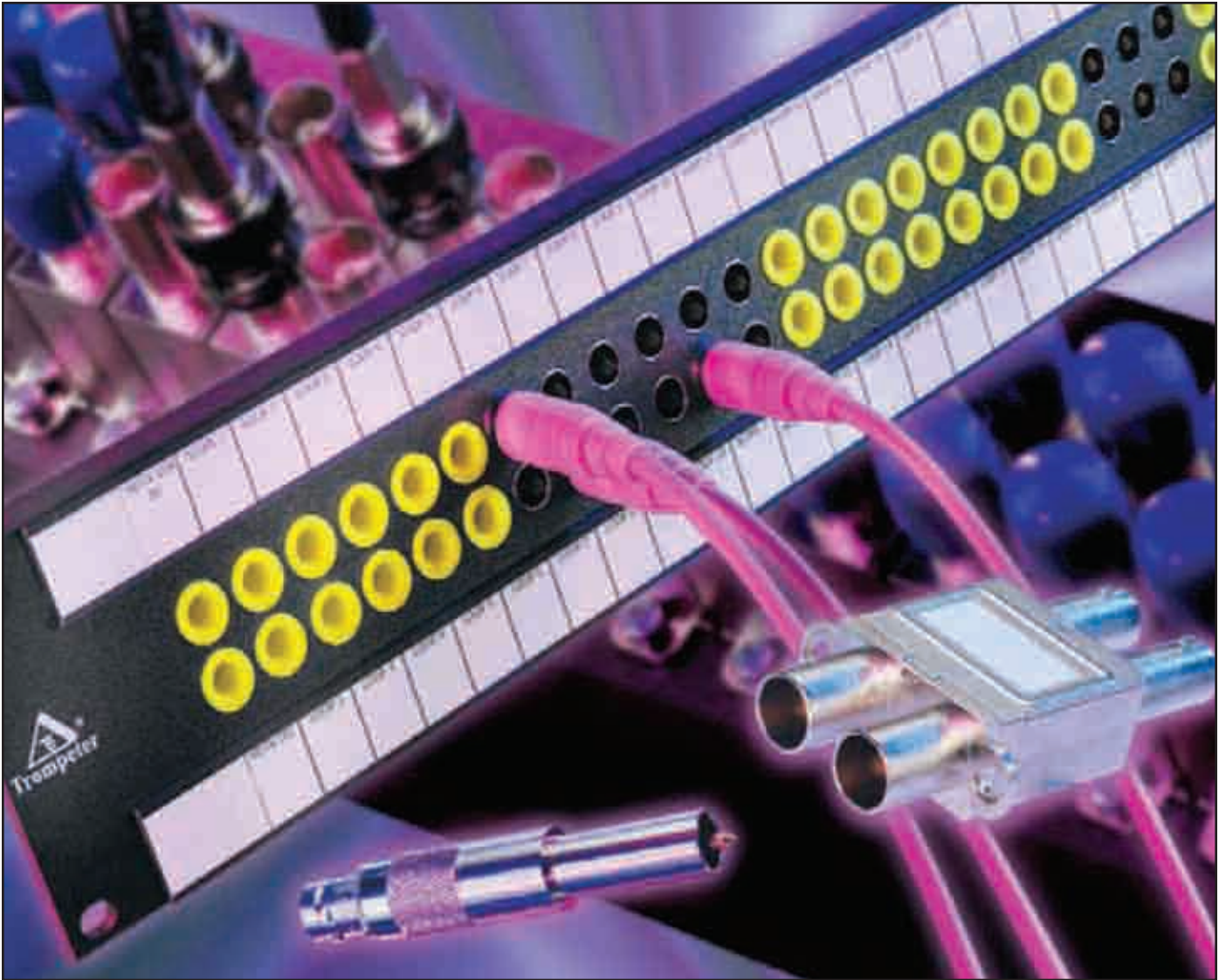

FEATURE

BENEFIT

Heat-treated beryllium copper actuator, outer contact and center socket contacts

Long life, low contact resistance and consistent forces

50 millionths of an inch gold plating on center socket contacts

Excellent contact resistance over time

Dielectrics are made of Teflon™

Superior dielectric properties. Superior heat and chemical resistance.

Self-wiping normalizing switch

Positive, reliable electrical contact over time.

Low profile rugged die cast body

Long life normal-thru and terminating contacts in a light-weight package

HDTV READY HIGH FREQUENCY VIDEO JACKS

HDTV TRANSMISSION LINE NETWORK PRODUCT SOLUTIONS—ALL TRUE 75 OHM

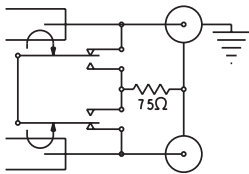
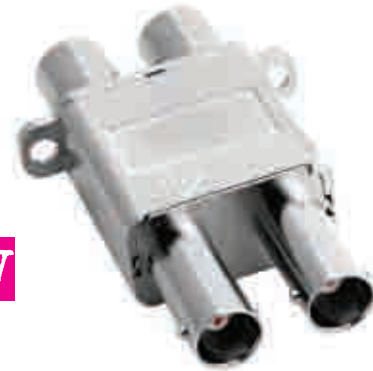
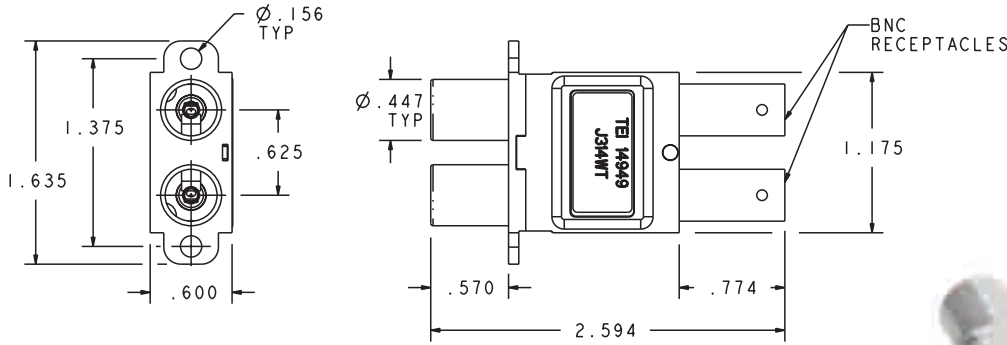

HDVDPT

HDVDPT (Self-terminating)

Inserting a plug into the source side automatically terminates the load side. Insertion into the load side automatically terminates the source side. Either provides a resistive load to the unused side.

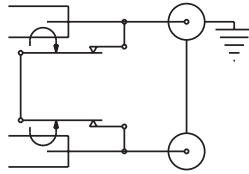

HDVDP

HDVDP (Non-terminated)

Inserting a plug into either side breaks the normal through. Normal-thru is BNC to BNC.



HDTV-Ready High Frequency 75 Ohm WECO Patch Jack, Normal-Thru, Dual Coaxial

Un-Terminated **HDVDP**
Terminated **HDVDPT**

Electrical Data

Characteristic Impedance	75 ohms nominal
Return Loss	Meets or exceeds the requirements of the following: SMPTE 292: S1, 1 < 15dB from 5MHz to 1.485GHz SMPTE 424: S1, 1 < 15dB from 5MHz to 1.485 GHz, S1, 1 < 10dB from 1,485GHz to 3GHz
Time Domain Requirements	Meets or exceeds SMPTE 292 & 424
Termination Resistor	75 ohms

Mechanical Data

Weight	34.2 grams
--------	------------

Material Data

Connector Housing	Zinc alloy, NI plated
Actuator and Center Conductors	Beryllium copper
Connector Dielectrics	PTFE



HDTV HIGH FREQUENCY MINI-WECO VIDEO PATCHING

HDTV TRANSMISSION LINE NETWORK PRODUCT SOLUTIONS - ALL TRUE 75 OHM

The J315MW is superior quality, high bandwidth, dual video patch jack. This low profile, high performance component is designed for HDTV digital applications where space allocation is critical, such as in video truck application, and is ideal in those situations where self-normalizing is not practical, usually due to environmental considerations such as high ambient airborne particles or high vibration. When used in conjunction

with the LPMWHF looping plug, a "normal-thru" circuit is achieved, which will pass a full 1.485 Gbps of uncompressed data (2.25 GHz of frequency) that is needed for HDTV, with return loss performance which exceeds SMPTE292M requirements. This high performance is maintained when patching from one location to another, using the PCMWB-L patch cord.

HDTV Ready High Frequency 75 Ohm Dual Coaxial Mini-WECO Patch Jack with BNC Receptacles

Un-Terminated **J315MW**

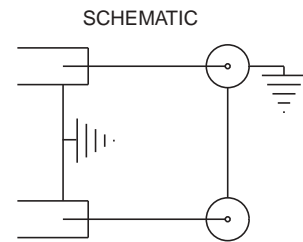
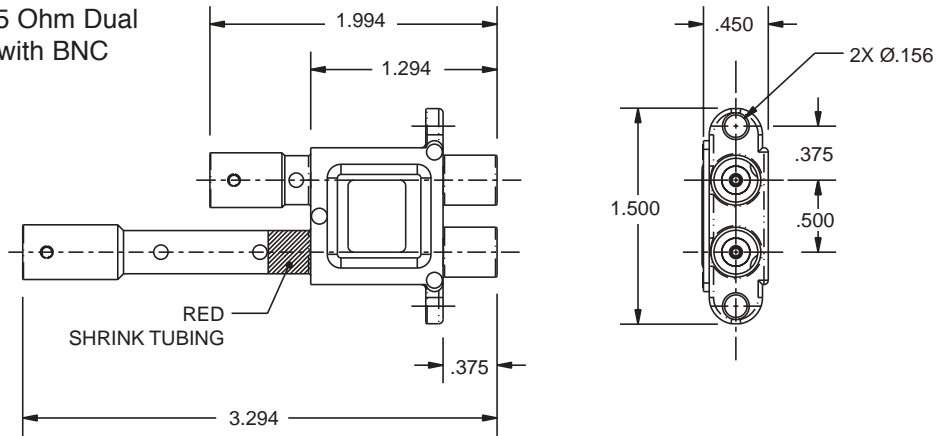

HDTV Ready High Frequency 75 Ohm Dual Coaxial WECO Patch Jack with BNC Receptacles

Un-Terminated **J315W**

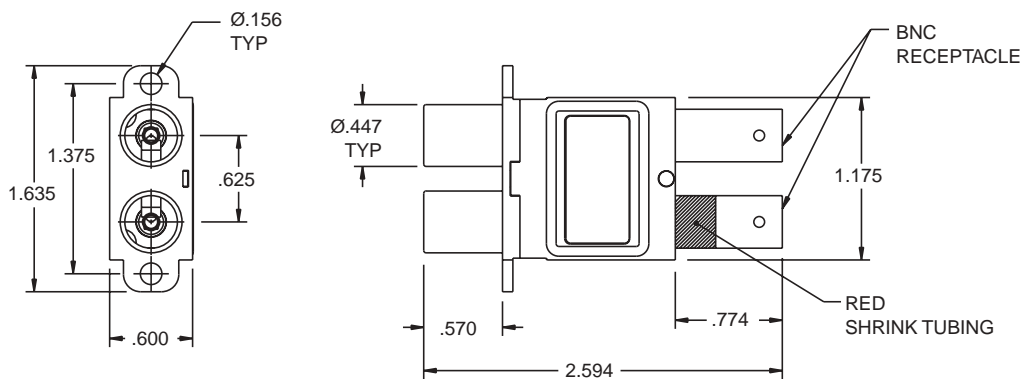

SCHMATIC

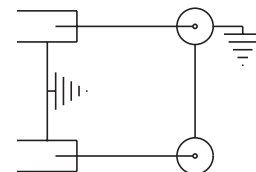

WECO MP20W VIDEO MONITOR PROBE

HDTV TRANSMISSION LINE NETWORK PRODUCT SOLUTIONS - ALL TRUE 75 OHM

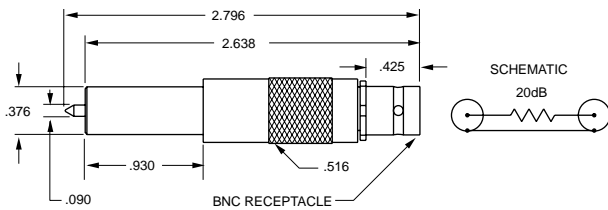
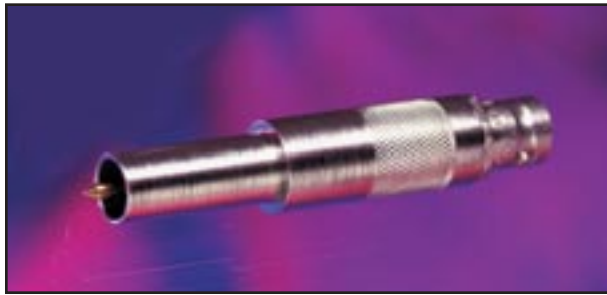

MP20W

75 Ohm Coaxial High Frequency Video Monitor Probe, WECO BNC Jack



Designed to be inserted into either of the J314W ports to allow sampling of the normal-thru data stream without reducing signal strength or otherwise interrupting the signal path.

DIALOG BOX

FREQUENCY

What frequency is required? Assuming an industry standard of 1080i with the current associated frame count and for an uncompressed signal, we know that 1.485 Gbps performance is needed. Assuming the use of alternate mark inversion coding, we can translate this into a base rate or "clock" frequency of 750 MHz. Currently the digital video processors are using the 3rd harmonic to achieve a square wave via Fourier Transform Series technology. Assuming this does not change, the HDTV in-station signal needs a wireline capable of handling 2.25 GHz for an uncompressed signal. Note that this is uncompressed. Obviously, with the use of digital compression (in digital technology, a file is a file, after all), far less bandwidth is actually needed for the HDTV broadcast transmission. However, there is significant interest in transporting uncompressed HDTV content for editing, mixing, branding, and routing for a variety of solid reasons. Uncompressed is worse case and we need to design for that condition.

There is some question regarding the need for upside "head-room" in frequency. It is possible that the industry will select 1080p and a higher number of frames per second to achieve computer standard picture quality but with additional frames for action sequence detail. If this happens, or if the standards people decide to utilize the 7th harmonic in lieu of the third, much more bandwidth and even higher frequencies will be necessary. For the purposes of what follows, we are limiting our concerns to 1080i uncompressed as the worse case wireline demand of the currently active considered HDTV standards.

Differences Between Plain Old TV Service (POTVS) and High Definition TV (HDTV):

TUTORIAL INFORMATION

Characteristic	POTVS	HDTV
Frequency	45 MHz	2.25 GHz (2,250 MHz)
Conductor	Full cross section	Surface only or "skin"
Dielectric	Voltage barrier	Propagation velocity, tight tolerance, low loss
Impedance	Modest importance	Must be matched, critically important to minimize reflection
Electromagnetic Field	Weak, not noticeable	Significant source of signal degradation
Ground	Return path	Boundary condition for field
Connectors	Insertion loss resistance (heat)	Reflection (VSWR) potentially signal canceling
Losses	Conductors (heat)	Dielectric (radiation)



HDTV VIDEO PANELS

HDTV TRANSMISSION LINE NETWORK PRODUCT SOLUTIONS—ALL TRUE 75 OHM

Standard 19" Panels In Popular Sizes and Configurations

Available in insulated black phenolic, and insulated or non-insulated aluminum. Aluminum panels are painted standard gray and come with either a phenolic black back (insulated type), and an aluminum back bar (non-insulated type). Aluminum panels can be painted to suit, or color matched (special order). Phenolic panels are available in black only.

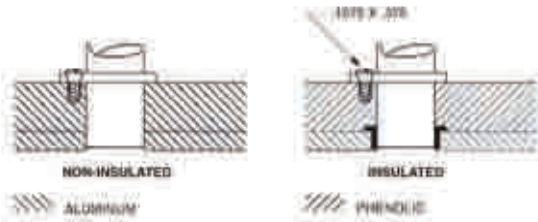

Panels available in heights of 1.75 inches (1RU) or 3.50 inches (2RU).

Custom Panels and Marking

Custom panels can be configured to meet your specifications, including special wiring, colors, engraving, or silk-screening (custom marking). Patch jack locations can also be marked on the rear of the panel for easy location of jacks. Please contact your local sales representative, or fax us your requirements.



HOLE PLUGS

Hole Plugs For:	Hole Diameter	Part Number
J8 - Miniature Patch Panel	.250"	HP250
HDVDP / J11—Miniature Patch Jack	.304"	HP304
HDVDP—Standard Patch Jack	.375"	HP375
JS-JSI—Standard Patch Panel	.437"	HP437
Misc.	.500"	HP500



Polyethylene Patch Jack Mini-WECO Covers (Black)
 Part Number: HP-304
 Vinyl BNC Jack Covers (Blue) Part Number : 700-0956
 Polyethylene Patch Jack WECO Covers (Yellow)
 Part Number: 700-0955



FULLY LOADED VIDEO PANEL PACKAGES

HDTV TRANSMISSION LINE NETWORK PRODUCT SOLUTIONS—ALL TRUE 75 OHM

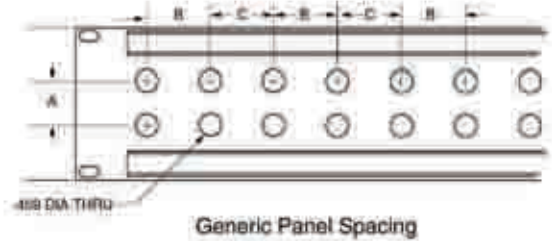
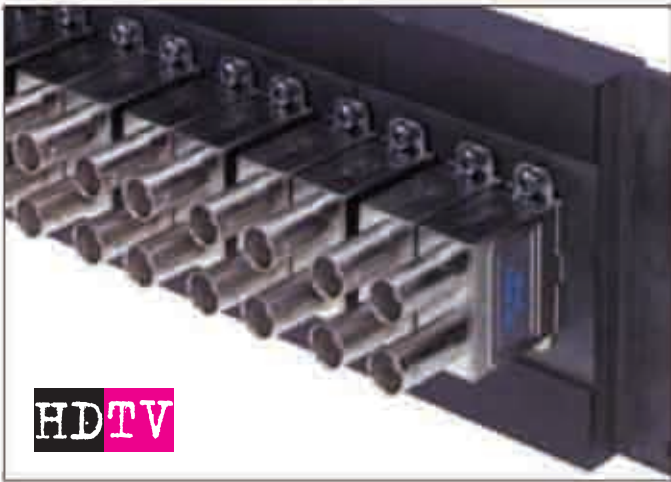

WECO

Fully loaded with HDVDP or HDVDPT
19" Black Phenolic Insulated Panels...

# of Holes	Panel Height	Hole Spacing			Fig	Part Number (Un-terminated) (Loaded Panel)	Part Number (Terminated) (Loaded Panel)
		A	B	C			
48	3.50"	.625"	.625"	.625"	C	JSIB-48A/HDVDP	JSIB-48A/HDVDPT
48	3.50"	.625"	.625"	.750"	C	JSIB-48/HDVDP	JSIB-48/HDVDPT
48	1.75"	.625"	.625"	.750"	C	JSIB-48S/HDVDP	JSIB-48S/HDVDPT
52	3.50"	.625"	.625"	.625"	C	JSIB-52/HDVDP	JSIB-52/HDVDPT
52	1.75"	.625"	.625"	.625"	C	JSIB-52S/HDVDP	JSIB-52S/HDVDPT
144	7.00"	.625"	.625"	.625"		JSIB-144/HDVDP	JSIB-144/HDVDPT

Note: JSIB-48 panel has staggered hole spacing in group of fours.
Cable management bars supplied for an additional cost.

Panel Figures Refer to Page 9

Mini-WECO

Fully loaded with HDVDPM or HDVDPMT 19" Black Phenolic Insulated Panels

# of Holes	Panel Height	Hole Spacing			Part Number (Panel Only)	Part Number (Un-terminated) (Loaded Panel)	Part Number (Terminated) (Loaded Panel)
		A	B	C			
64	1.75	.500	.500	.500	JSMW64S	JSMW64S/HDVDPM	JSMW64S/HDVDPMT
64	3.50	.500	.500	.500	JSMW64D	JSMW64D/HDVDPM	JSMW64D/HDVDPMT
128	3.50	.500	.500	.500	JSMW128	JSMW128/HDVDPM	JSMW128/HDVDPMT

JSMW64S - Black Phenolic Single Rack Unit Spaced Panel

JSMW64D - Black Phenolic Two Rack Unit Panel with Wider Designation Strips

Panels can be used with J11MW - J11MWL Jacks

DIALOG BOX

SCREEN RATIOS

HDTV is a 16:9 ratio. Compared to the television picture of today, HDTV is 33% more area for the same virtual picture.

Screen Sizes [ratios]

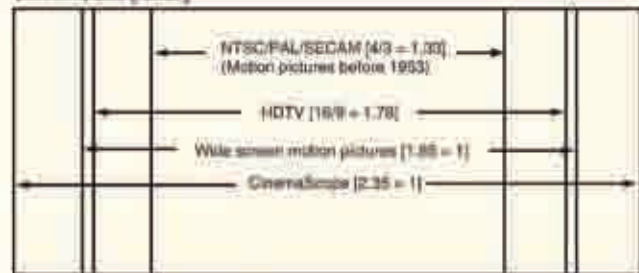

Comparison of common display aspect ratios



HDTV VIDEO PANELS

HDTV TRANSMISSION LINE NETWORK PRODUCT SOLUTIONS—ALL TRUE 75 OHM

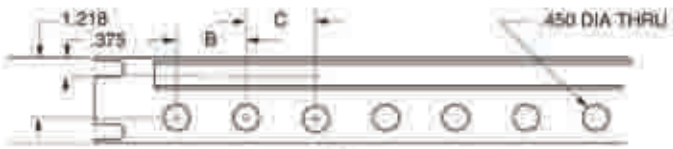

FIG A

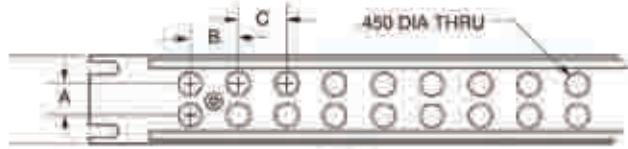

FIG B

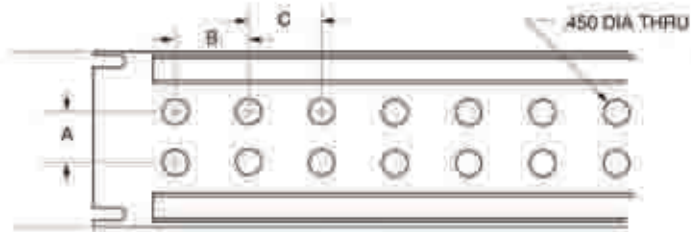

FIG C

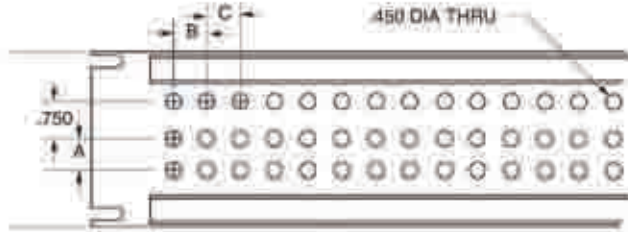

FIG D

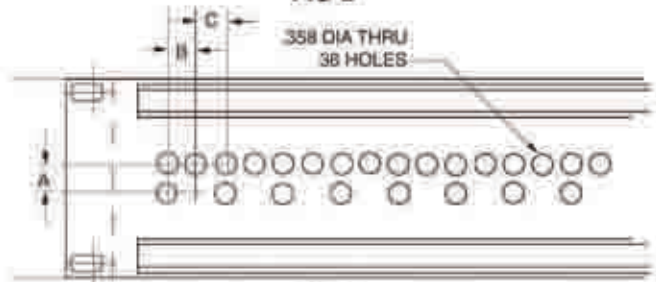

FIG E

Ordering Fully Loaded Panels...

Panels can be ordered pre-loaded with any compatible jacks without additional labor charge by using the following part number format (provided the mechanical restrictions are recognized). Contact factory for assistance.

Example: JSIB48/HDVDPT; 48 Hole Spacing, Insulated Black Phenolic Panel (JSIB-48), Loaded with twenty four (24) Serial Digital Normal-thru Terminated Video Patch Jacks (HDVDPT)

Sample Panel Part Number: JS (I) (B) - 48/HDVDPT

JS: Non-Insulated Aluminum Panel (grey)
 JSI: Insulated Aluminum Panel (grey)
 JSIB: Insulated Phenolic Panel (black)

Number of Holes
 Patch Jack Part Number

DIALOG BOX

TWO CHANGES - DIGITAL AND BANDWIDTH PIXEL COUNTS

TYPE	VERTICAL LINES	HORIZONTAL LINES	DATA RATE IN Gbps
NTSC	525	487	Analog
SDTV	480	640	.270
DTV-W	480	704	.270
HDTV	1080	1920	1.485

Gbps = gigabits per second

HDTV VIDEO PANELS

HDTV TRANSMISSION LINE NETWORK PRODUCT SOLUTIONS - ALL TRUE 75 OHM

Standard 19" Panels...Insulated, Non-Insulated

See page 9 for panel figures.

# of Holes	Panel Height	Hole Spacing			(foot) note	Fig	•DS Strip	Gray Aluminum		Black Phenolic
		A	B	C				Non-Insulated Part #	Insulated Part #	Insulated Phenolic Part#
1.75 Inch Standard Size Panels (1 Rack Unit)										
12	1.75	-	1.43	1.43	1	A	DS1	JS-12	JSI-12	
14	1.75	-	1.21	1.21	1	A	DS1	JS-14	JSI-14	
16	1.75	-	1.00	1.00	1	A	DS1	JS-16	JSI-16	
20	1.75	-	.830	.830	1	A	DS1	JS-20	JSI-20	
24	1.75	-	.625	.750	1	A	DS1	JS-24S	JSI-24S	JSIB-24S
26	1.75	-	.625	.625	1	A	DS1	JS-26	JSI-26	
28	1.75	-	.625	.625	1	A	DS7	JS-28	JSI-28	
32	1.75	.625	1.00	1.00	2	B	DS4	JS-32S	JSI-32S	JSIB-32S
40	1.75	.625	.830	.830	2	B	DS4	JS-40S	JSI-40S	JSIB-40S
48	1.75	.625	.625	.750	2	B	DS4	JS-48S	JSI-48S	JSIB-48S
52	1.75	.625	.625	.625	2	B	DS4	JS-52S	JSI-52S	JSIB-52S
56	1.75	.625	.625	.625	2	B	155-0218-24 DS4	JS-56S	JSI-56S	JSIB-56S

3.50 Inch Standard Size Panels (2 Rack Units)

24	3.50	.625	1.43	1.43	2	C	DS1	JS-24L	JSI-24L	
24	3.50	1.00	1.43	1.43	1	C	DS1	JS-24W	JSI-24W	
28	3.50	.625	1.21	1.21	2	C	DS1	JS-28A	JSI-28A	
28	3.50	1.00	1.21	1.21	1	C	DS1	JS-28W	JSI-28W	
30	3.50	.625	1.125	1.125	2	C	DS1	JS-30	JSI-30	
30	3.50	1.00	1.125	1.125	1	C	DS1	JS-30W	JSI-30W	
32	3.50	.625	1.00	1.00	2	C	DS1	JS-32A	JSI-32A	JSIB-32A
32	3.50	1.00	1.00	1.00	1	C	DS1	JS-32W	JSI-32W	
36	3.50	.625	.625	.750	2	E	DS1	JS-36	JSI-36	
36	3.50	.625	.830	.830	2	C	DS1	JS-36A	JSI-36A	
40	3.50	.625	.830	.830	2	C	DS1	JS-40	JSI-40	JSIB-40
40	3.50	1.00	.830	.830	1	C	DS1	JS-40W	JSI-40W	JSIB-40W
48	3.50	.625	.625	.750	2	C	DS1	JS-48	JSI-48	JSIB-48
48	3.50	.625	.625	.625	2	C	DS1	JS-48A	JSI-48A	JSIB-48A
48	3.50	1.00	.625	.750	1	C	DS1	JS-48W	JSI-48W	
52	3.50	1.00	.625	.625	1	C	DS7	JS-52W	JSI-52W	JSIB-52W
52	3.50	.625	.625	.625	2	C	DS1	JS-52	JSI-52	JSIB-52
56	3.50	.625	.625	.625	2	C	DS7	JS-56	JSI-56	JSIB-56
56	3.50	1.00	.625	.625	1	C	DS7	JS-56W	JSI-56W	
72	3.50	.625	.680	.680	3	D	DS1	JSS-72	JSIS-72	JSISB-72

Dimensions are in inches. Jacks sold separately.

•DS stands for designation strip - Only applies to JS and JSI part numbers. Does not apply to phenolic panels (JSIB, JSIX)

Notes:

- 1: Will not accept dual jacks, single barrel jacks only (J3W)
- 2: Will accept dual or single barrel jacks.
- 3: Will accept 3 barrel jack only (J25W).

Standard Designation Strips
For JS, JSI, JSIS Part Numbers Only

For JSIB Panels Figures B and C have .459 diameter typ.

For Phenolic Panel (JSIB) Designation Strips Contact the Factory



COMPONENT VIDEO

HDTV TRANSMISSION LINE NETWORK PRODUCT SOLUTIONS—ALL TRUE 75 OHM

In addition to Trompeter's HDVDP and HDVDPM jack series, the new J25W RGB triple patch jack makes patching easier than ever. Standard 75 ohm BNC's are used on the rear and beryllium copper center contacts provide long life performance of over 30,000 minimum mating cycles. The new phenolic RBG panel offsets the patch locations of the RGB ports to avoid component mismatching. Double dress bars lend support for installation cable management. The 155-0874, 155-0852 and 155-0887 offer triple patch cords for patching all three components simultaneously.

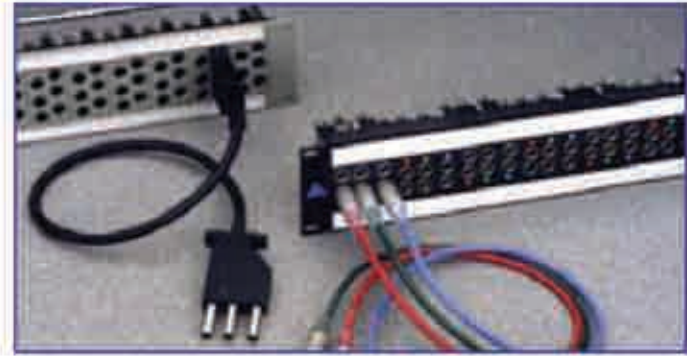

RGB Patch Panel Insulated Black Phenolic

155-0874 (48 Hole)

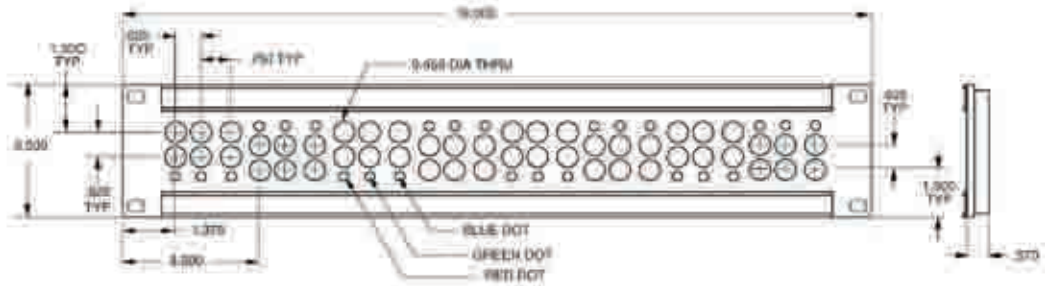

Patch Panel Insulated Gray Aluminum Panel

155-0852 (72 Hole)

155-0887 (84 Hole)

To be used with J25W
(Triple Patch Jack - see next page)

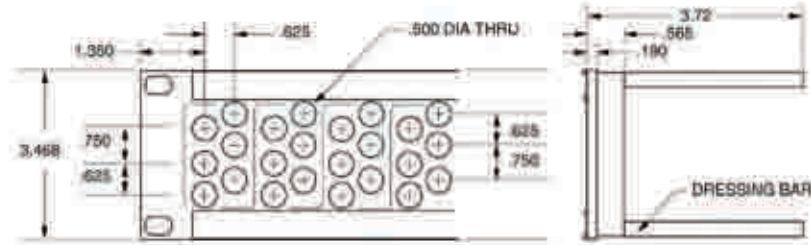

RGB Triple Patch Cord Component Patching Red-Green-Blue

PCWRGB-L-75

(L - Length in Inches) See page 15 for other patch cords.

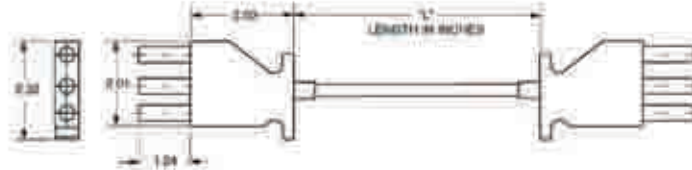

Panel Designation Strip Labeling Software



Trompeter provides, upon request, a free designation strip software package. With this easy-to-use program, the technician can create custom designation strips for attractive, professional panel labeling. The software is provided on a diskette and works with Microsoft Word® 97 or higher. Operating system requirements: Windows® 95 or higher required.

OTHER 75 OHM WECO PATCHING

HDTV TRANSMISSION LINE NETWORK PRODUCT SOLUTIONS - ALL TRUE 75 OHM

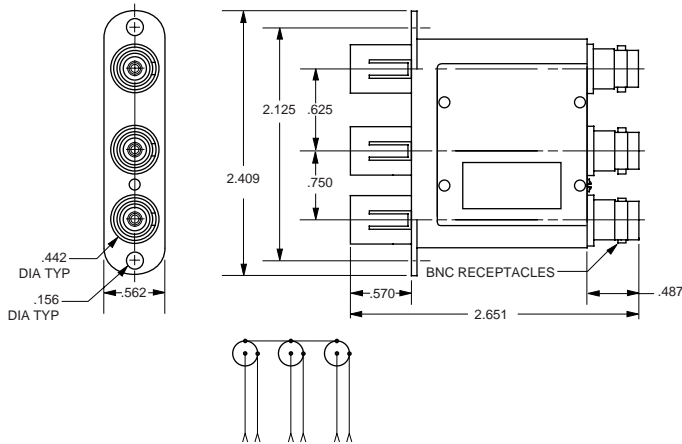

RGB PATCH JACK

The J25W single type features offset patch locations of RGB ports to eliminate mismatching of components. The J25W uses a feed-through design, allowing signals to be routed by the use of our triple patch cords.

Normal-Thru with Monitor
75 ohm Triple Patch Jack

J25W

The J25W is not yet rated for HDTV uncompressed data rates.

HIGH FREQUENCY PATCH JACK

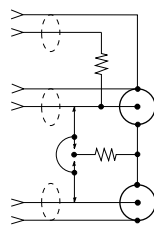
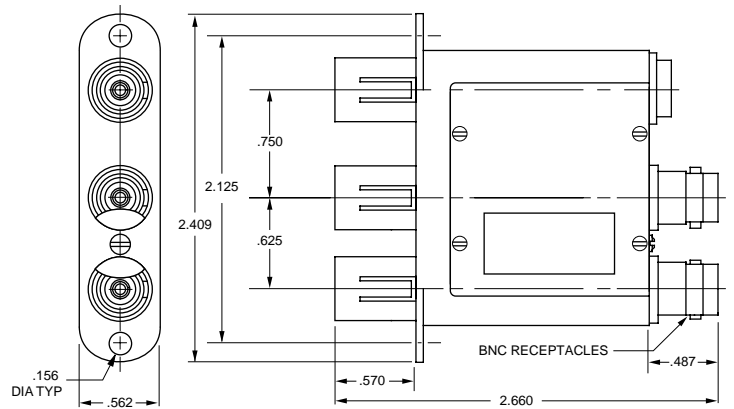

SCHEMATIC

The **J24WMSTHF-75** is a 75 ohm high frequency, self-terminating patch jack, with a separate 20 dB monitor jack for monitoring the normal-thru 600 MHz, 300 Mbits digital signal. The J24WMSTHF-75 is designed for use in serial digital video applications where monitoring of a signal is required without altering the source signal. The 20 dB monitor port allows for the use of a standard patch cord without special attenuator or other devices to split the signal.

The J24WMSTHF-75 is not yet rated for HDTV uncompressed data rates.

J24WMSTHF-75 FEATURES:

Separate 20 dB monitor jack
Rugged simplified design

2.5lbs minimal withdrawal force
Heat treated beryllium copper actuator
and center socket contacts
50 millionths inch gold plating
with duplex underplate

Standard Western Electric 75Ω
patching interface
Dielectrics are made of Teflon

BENEFITS:

Easy monitoring of the normal-thru signal
Higher reliability, rated at 30,000 mating cycles
Long life normal-through and terminating contacts
Positive, reliable electrical contact over time

Minimizes accidental removal of patch plugs in a dynamic environment
Long life, low contact resistance and consistent contact forces

Excellent contact durability over time

Uses all existing patch plugs, looping plugs, and other support equipment

Superior dielectric properties. Superior heat and chemical resistance



75 OHM WECO PATCHING COMPONENTS

HDTV TRANSMISSION LINE NETWORK PRODUCT SOLUTIONS - ALL TRUE 75 OHM

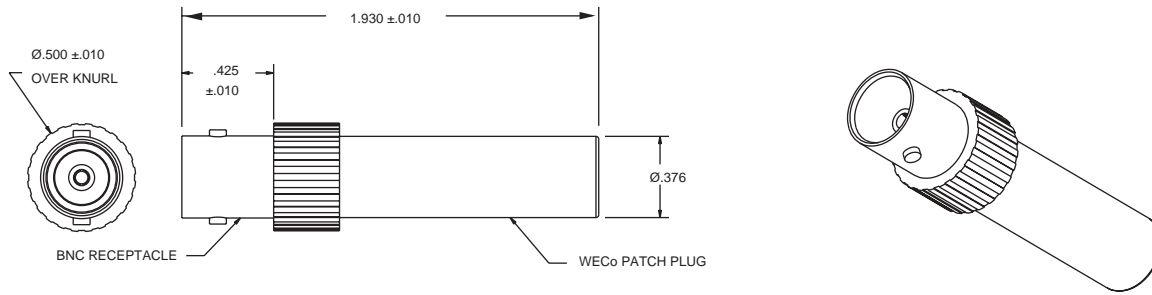

75 Ohm BNC to 75 Ohm WECO-Type
Patch Plug for HDTV
High Definition TV

AD1WHD

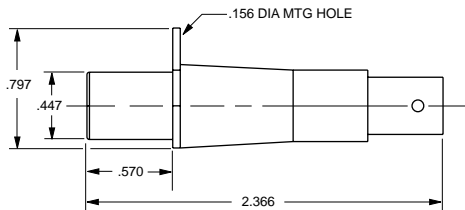

Single Patch Jack
BNC Rear Interface, Standard

J3W

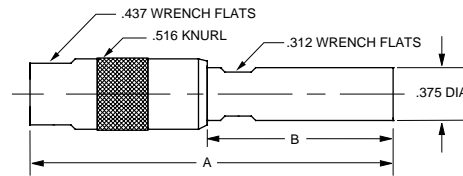

Single Patch Plug
RG59 Cable, Wrench Crimp
A = 2.45 B = 1.22

PL2W

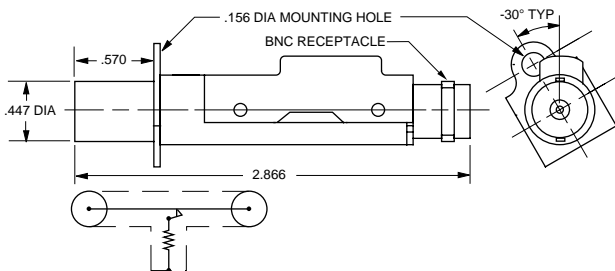

Single Patch Jack
BNC Rear Interface,
Self-terminating

J13W-75

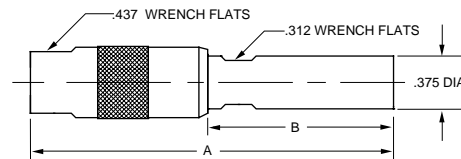

Single Patch Plug
Tool Crimp, WECO 358 Type
PL1WC-(cable groups call factory)
A = 2.45 B = 1.22

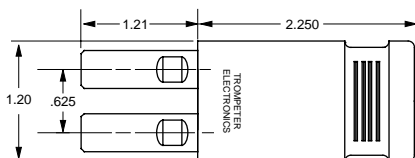

Video Looping Plug
Video (Hair Pin)
75 Ohm WE, .090" Center Pin

LPW-75

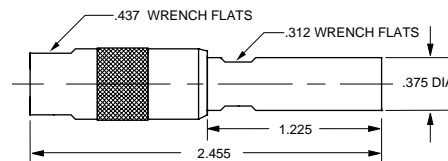

Termination Plug
Standard, WECO 340C Type

TPW-1-75

75 OHM MINI-WECO PATCHING COMPONENTS

HDTV TRANSMISSION LINE NETWORK PRODUCT SOLUTIONS - ALL TRUE 75 OHM

	A	B	C
J11B	.264	.295	.638
J11MW	.375	.375	.728

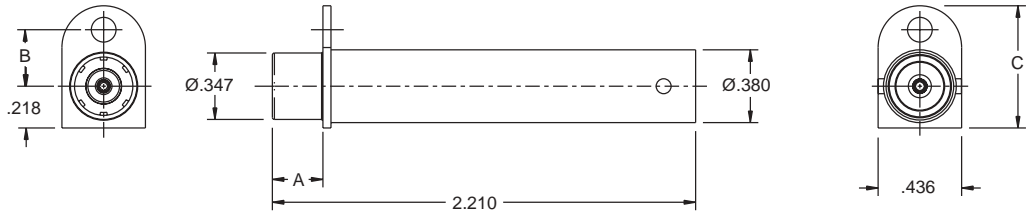

Miniature Patch Jack
Between Series Adapter 75 ohm Coaxial AT&T
Type Miniature Patch Jack to Female 75 ohm BNC
Receptacle
J11MW

	A	B	C
J11BL	.264	.295	.638
J11MWL	.375	.375	.728

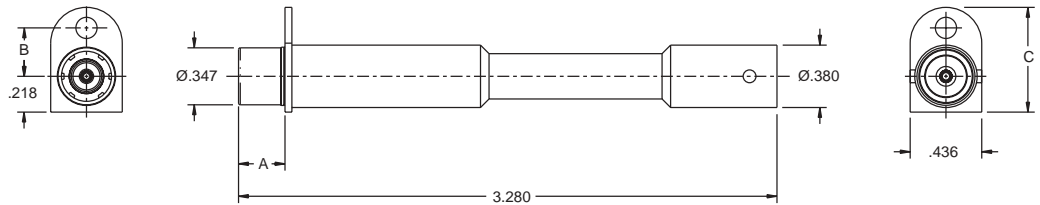

Miniature Patch Jack
Between Series Adapter 75 ohm Coaxial AT&T
Type Miniature Patch Jack to Female 75 ohm BNC
Receptacle
J11MWL

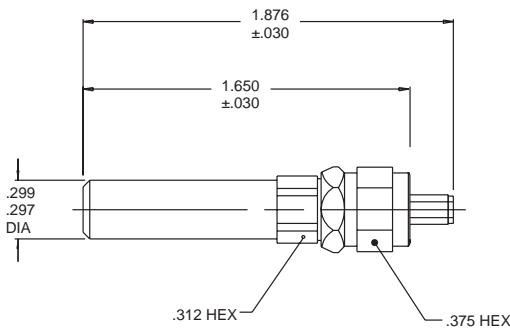

Miniature Patch Plug
75 Ohm Coaxial Miniature Tool Crimp Patch Plug
(WECO 440 Type)
PL1MW-(cable groups call factory)

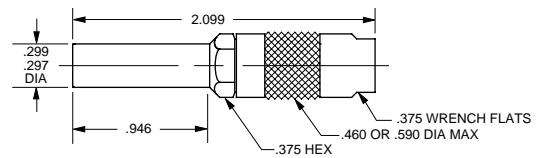

Miniature Patch Plug
Solder Contact, Crimp Shield
(WECO 440 Type)
PL11C-(cable groups call factory)

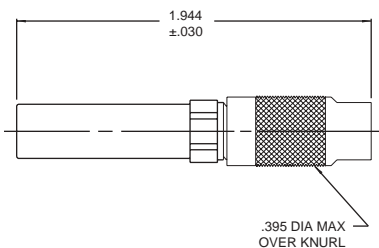

Miniature Termination Plug
75 Ohm, No Chain
TPMW-1-75
Chain/Rope options available contact factory.

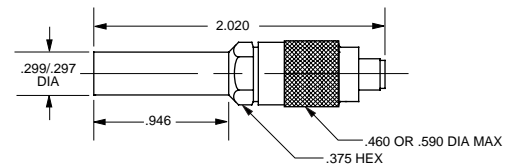

Miniature Patch Plug
"All Crimp"
Crimp Contact, Crimp Shield
(WECO 440 Type)
PL11AC-(cable groups call factory)



CABLE ASSEMBLIES

HDTV TRANSMISSION LINE NETWORK PRODUCT SOLUTIONS - ALL TRUE 75 OHM

For over 35 years, Trompeter has been producing high quality cable assemblies, and currently provides over 500,000 different configurations using a broad range of RF connectors and cable types. We stock a variety of components for camera, RGB, S-Video, audio, and many other applications.

Capabilities

Trompeter can provide patching products with special marking (ID sleeves/tags, hot stamping, colored cable jacket, etc). Trompeter offers 24-48 hour turn-around on many standard products with full capabilities for sustained volume delivery. Deliveries can be adjusted to meet your specific needs.

Trompeter's assemblies are 100% electrically tested for continuity, shorts, and Hi-Pot. (Voltage Standing Wave Ratio (VSWR), Isolation Resistance (IR), Insertion/Return Loss test capabilities, SPC data available on request.

Trompeter's coax patch cords and cable assemblies are of the highest quality and can be ordered in any length. Trompeter normally stocks popular lengths of 18", 24", 36", 48", 60" and 72".

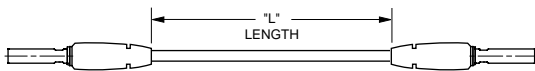

WECo Video Patch Cords

Patch Plug to Patch Plug

75 Ohm WECO, .090" Center Pin

PCW-L-Z (Red, Black, Yellow, Green, Blue, Violet)

Specify color when ordering video patch cords. Replace "L" with length in inches (Most common lengths: 12", 18", 24", 36", and 48") Example: PCW-24-75RED - 24 inch Video Patch Cord, Red colored cable.

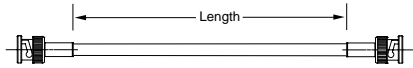

WECo Cable Assembly

UPL2000 BNC Plug to UPL2000 BNC Plug

Tool Crimp BNC 75 ohm

UPCYB-L-Z

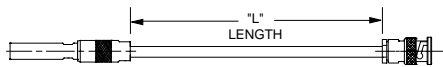

WECo Cable Assembly

Patch Plug to BNC Plug

75 ohm WECO Center Pin .090"

75 ohm BNC **UPCWX-L-Z**



Mini-WECO Patch Cords:

PCMWB-(length in inches)

Broadcast mini-Weco 75 ohm patch plugs and 75 ohm cable for use with J314MW series patch jacks.

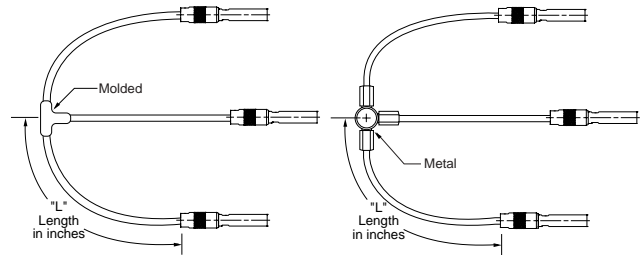

WECo Cable Assembly

Patch Cords: Triple Paralleling

Junction	Standard	Max Length	Part #
Molded	75 ohm WECO center pin .090"	14"	PCWS-L-75
Metal	75 ohm WECO center pin .090"	none	PCWSE-L-75

Request For Quotes...Please refer to the following guideline when requesting a quote:

1	2	3	4	5	6
Quantity	Connector 1	Cable	Connector 2	Length	Special Requirements
12	UPL2000-D5	Belden 7731A	UPL2000-D5	60"	none

- 1 Quantity
- 2 Connector 1.....Select from connectors in this catalog or call factory.
- 3 Cable.....Select from cables in this catalog or call factory.
- 4 Connector 2.....Select from connectors in this catalog or call factory.
- 5 Length.....In Inches
- 6 Write out any special marking, testing, bend relief, packaging, or other special requirements.

* Contact factory more information on other connector types and cables.
 "L" denotes the length in inches. "Z" denotes the impedance of the connecting cable.

BNC CABLE BEND RADIUS TUTORIAL

HDTV TRANSMISSION LINE NETWORK PRODUCT SOLUTIONS - ALL TRUE 75 OHM

Lateral Connector Strain, Cable Radius Issues, and Equipment Airflow Management with BNC Connectors

The conventional copper based wiring bays of today's telephony central office, CATV headend, or broadcast studio are substantial users of BNC connectors for the termination of coaxial cable transmission lines. Usage of copper based coaxial cable still carries significant advantages in cost, ease of use, high data rate signal clarity, and bandwidth. Despite the huge capacity available in fiber optic technology and continued attempts (such as xDSL) to utilize the enormous installed base of twisted pair copper, coax is still a favorite and proven technology with very low risk and extremely low line failure rates.

However, as line density has gone up, so has the amount of cable that is attached to the backs of these bays. In the case of video patch bays, the number of BNCs connecting cable to the equipment can be enormous. There are two problems with this that are the topic of this brief article.

First, the weight of the cable itself acts as a lateral force on the BNC connector. If a low cost connector is used (usually manifested by the substitution of inferior materials), the constant lateral downward pressure can, over time, deform the coupling wave washer, which provides the positive mating force so unique to the BNC style connector.

Conversely, using a high quality BNC connector eliminates this risk. This downward lateral force on a straight BNC connector is more significant the greater the cable "fall" and cable diameter, and top bay equipment is more subject to this simple gravity impact than is the lower bay equipment.

While the bundles of hanging wire may be cable tied, this usually is done for neatness and not for weight-relief. Another consideration is the weight on the jack and the panel front itself.

Perhaps the most important issue is the radius or bend that the cable itself takes in making the transition from horizontal (in line with the jack and BNC) to the vertical (gravity). To the extent that the cable deforms over time, this radius reduction can deform the critical dielectric spacing in the cable and negatively alter transmission line performance. The higher the frequency, the more pronounced this effect becomes. See Cable Bend Radius Examples illustration. All of the above-mentioned problems are exasperated by the increasing use of lower loss cable for longer runs or higher bandwidth and frequency capabilities. This all translates into more weight.

One simple solution is utilizing a 90° or 45° connector to solve the issue of degrading cable bend radius due to weight. Bent relief "boots" to help contain the lower radius limit can also help.

Yet another result of this density problem is the "curtain effect" or blockage of airflow circulating in the rack units. This blockage of proper airflow has potentially serious service life-reducing impact on sensitive electrical equipment. Thermal degradation of electrical equipment due to insufficient air movement and radiant cooling is well documented. Suffice it to say air movement is good, and blockage of air movement from a curtain of hanging cable is not.

Perhaps a more elegant solution to the issues raised here involves the use of 45° BNC's (see "Best" in visual side view example below), which typically cost the same as a 90° BNC. Using 45° connectors, each plug can be nested over the next, directing the associated cable horizontally to the side of the rack unit. From there, the cable can be tied off to the rack, which removes the weight strain, regardless of the height of the equipment in the bay. Most importantly, the approach allows maximum uninterrupted airflow throughout the cabinet, allowing full radiant cooling.

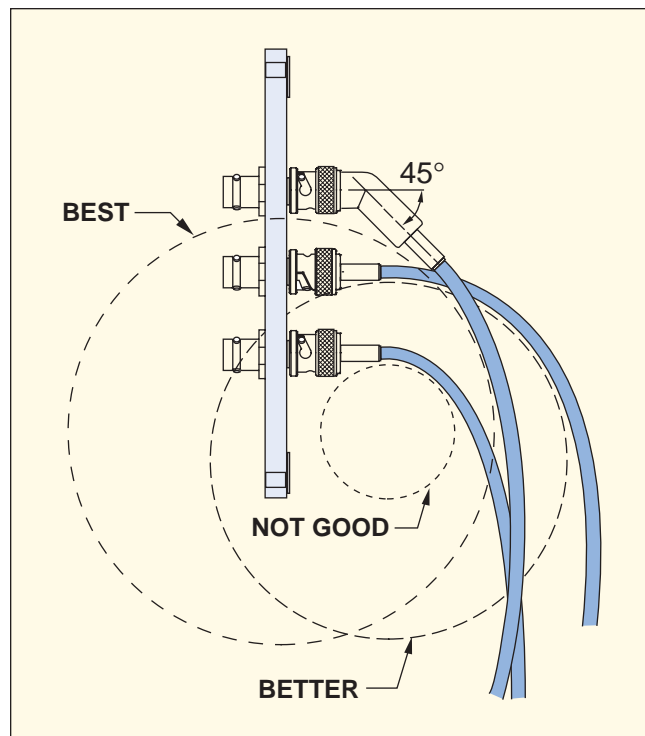

Cable Bend Radius Examples



75 OHM UPL2000 DIGITAL VIDEO BNC

HDTV TRANSMISSION LINE NETWORK PRODUCT SOLUTIONS - ALL TRUE 75 OHM



The Trompeter **UPL2000** is a classically robust, high frequency, true 75 ohm BNC connector that is designed to handle high bit-rate digital video signal transmissions in conjunction with the low loss coaxial cables used in broadcast applications.

With Trompeter's typical emphasis on exceptional signal clarity, low noise, rugged design, and tight tolerance construction, the UPL2000 gives long-term field performance at high frequency to allow error-free transmission of digital signals. This is true over the entire bandwidth utilized by HDTV signal transport whether the signal is compressed or uncompressed.

Our test engineers are looking at return loss performance of -30 dB up through 3GHz and calling it the **stealth connector**, so good you almost don't know it is there... (see chart on page 19).

Trompeter design engineers understand the unique problems associated with the combination of high data rate digital traffic and high frequency transmissions. The unique design of the UPL2000 allows for an impedance matched transition through the connector, taking advantage of the electromagnetic effects that are so unique to high frequency transmission lines. The signal is contained within the inside surface of the outer shield through the connector in much the same way that the braid of the coax cable contains the electromagnetic energy of the signal within the cable dielectric itself. This effect is more pronounced as transmission frequency rises, as is the case with DTV and HDTV.

The connector is offered in the larger diameter cable sizes that are supporting transmission of the video broadcast signal in stations, post-production, and CATV headends.

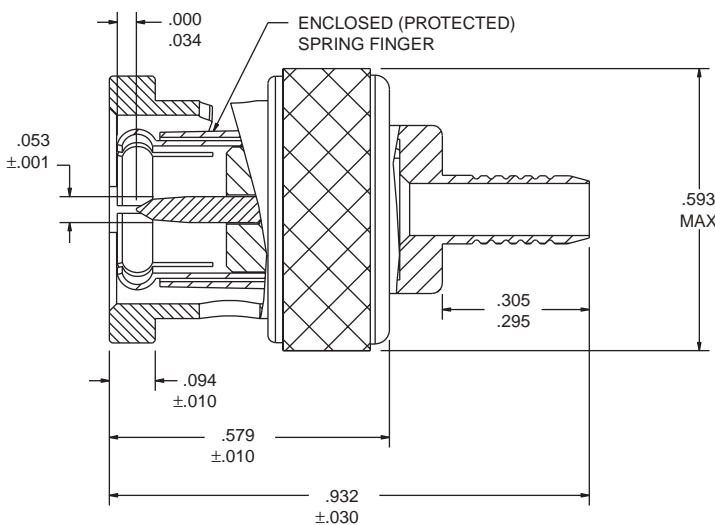

UPL2000 RETURN LOSS DATA

Only variable is manufacturer of BNC connectors

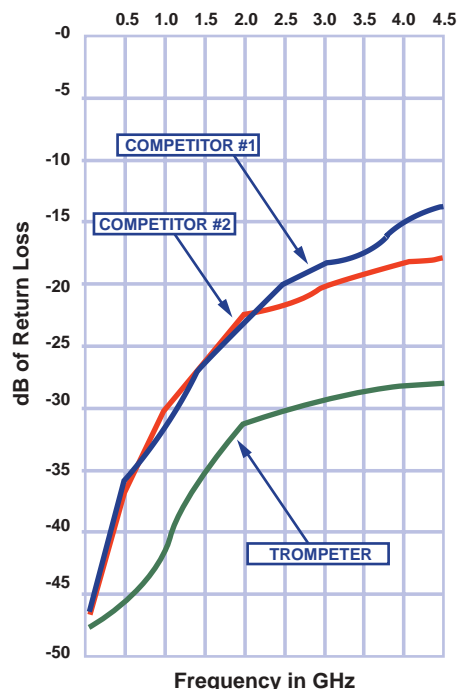

NOTE: Test setup includes one foot Belden 1505A coaxial cable with BNC plug each end plus adapter and termination.



75 OHM UPL2000 DIGITAL VIDEO BNC

HDTV TRANSMISSION LINE NETWORK PRODUCT SOLUTIONS - ALL TRUE 75 OHM

17 Reasons Why Trompeter BNC Connectors Outperform the Competition Everytime!

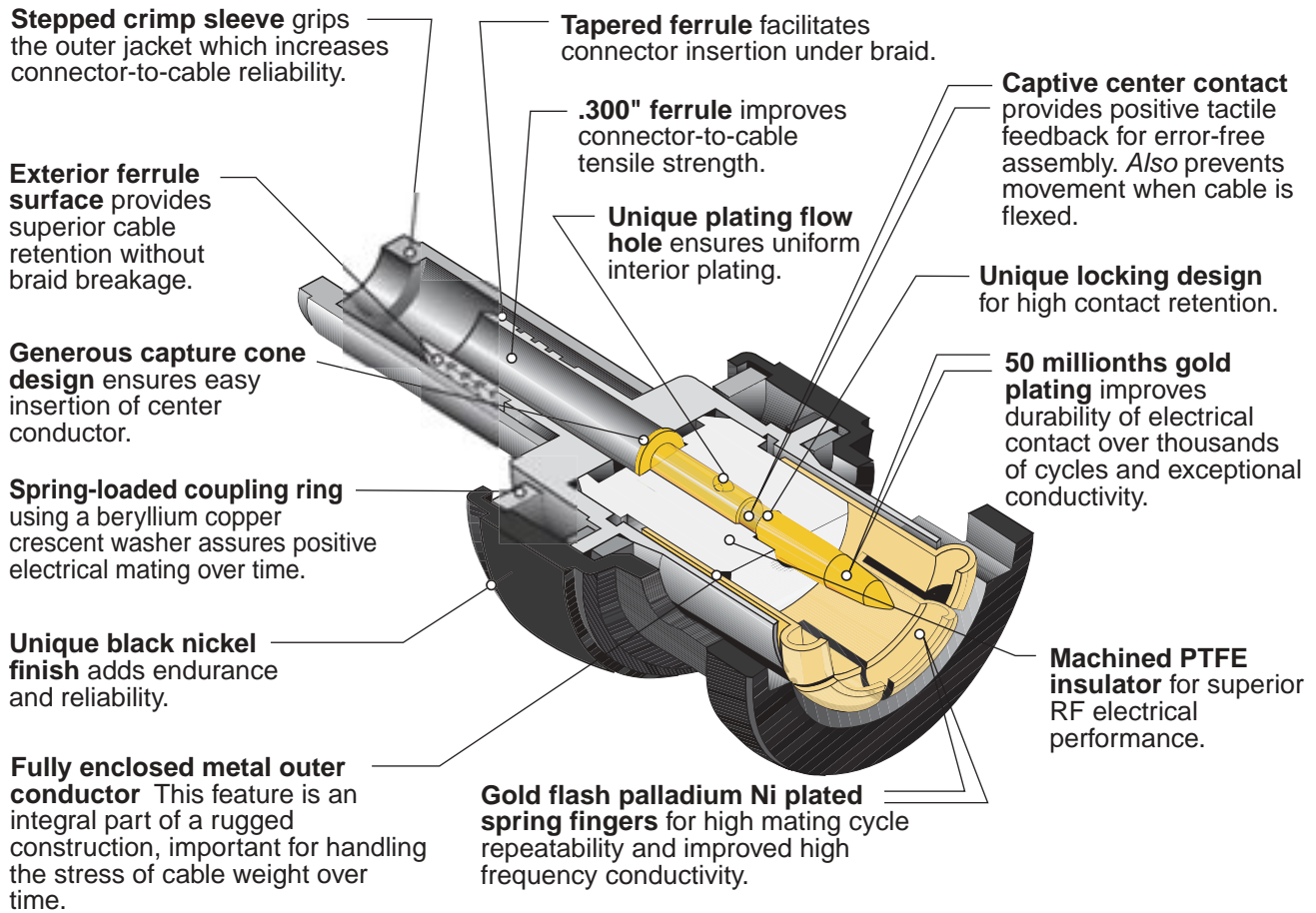

**Return Loss Performance
UPL2000-D4 on Belden 1694A**

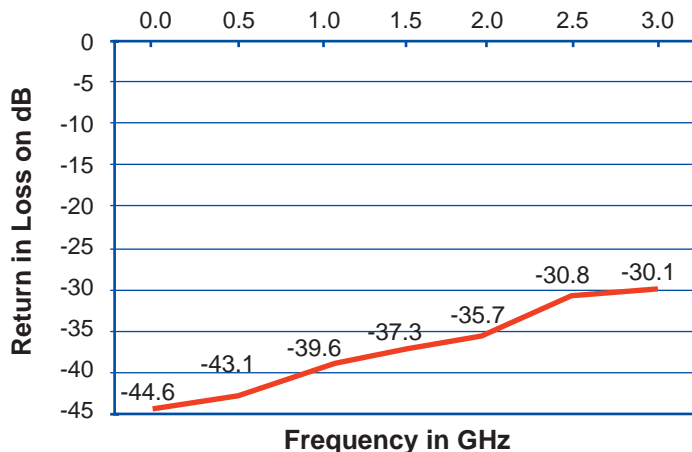

DIALOG BOX

COAX CABLES

The **coax cable** used in transporting the HDTV signal from place to place within a facility is quite good (it will, however, all still need to be replaced since it was designed in around lower frequency and higher insertion loss conditions). The major cable manufacturers that serve this segment have not stopped innovating to achieve better and better insertion loss performance. Use of low dielectric materials and lower dielectric constant materials is growing. Typical values on some new cable types today are 26 dB loss for 100 meters of length at 1 GHz! (Note that the key technical issue of cable selection is insertion loss over distance). Further, the trade off of overall cable diameter, cable weight, and cost are being attended.



75 OHM UPL2000 DIGITAL VIDEO BNC

HDTV TRANSMISSION LINE NETWORK PRODUCT SOLUTIONS - ALL TRUE 75 OHM

Electricals and Electromagnetics:

True Impedance	75 ohms
Voltage Rating	500 VAC RMS
Insertion Loss	0.2 dB max up to 3 GHz (tested as a 3ft cable assembly)
Return Loss	See page 17 - test method and result is one UPL2000 plug on each end of 12 inches of cable, network analyzer calibrated with load prior to each test, statistical sampling.
Contact Resistance	4 milliohm max end-point after environmental testing (see below) with a current of 5 ma max; 20 mv open circuit
Insulation Resistance	5000 megohms minimum
Operational Frequency	Up through 6 GHz
VSWR	Not more than 1.2 up to 3 GHz
Dielectric Withstanding Voltage	1500 VAC RMS with no breakdown

Materials:

Body	Electrolytic nickel over brass
Bayonet	Black electroless nickel over zinc
Dielectric	Machined polytetrafluoroethylene (PTFE, aka Dupont trade name Teflon)
Spring Finger	Gold flash palladium over nickel over copper over phosphor bronze or BeCu
Gasket	Silicone rubber
Wave Washer	Electrolytic nickel over beryllium copper
Center Contact	Thick (50 millionths of an inch minimum) gold over nickel over copper over brass

Environmental:

Thermal Shock	-40 to +85 degrees C operating
Moisture Resistance	MIL-STD-1344 Method 1002, test condition C, 500+ hours/40 degrees C/90-95% RH
Corrosion Resistance	MIL-STD-1344 (48 hours salt spray)
Vibration	MIL-STD-1344 Method 2005 with no bit loss @ 45 Mbps @ 20G's (BER test)
Solvent Resistance	MIL-STD-202 Method 215

Mechanical Tested Values:

Mating Cycle Rating	500 cycles
Center Contact Retention	6 lbs minimum axial load
Coupling Mechanism Pull Test	100 lbs typical
Force to Engage	5 lbs maximum
Interface Dimension	MIL-C-39012 modified for true 75 ohms (TEI TGS-5)
Outer Contact Pin Gauge Retention	> 260 grams minimum after 500 cycles
Cable Retention at Crimp Sleeve	See chart below - exceeds 40 pounds minimum

Top 3 UPL2000 Product Features

Features:

1 Center Contact:

- Captivated and locking
- 50 micro inches gold

2 Outer Contact

- Gold flash palladium Ni
- Phosphor bronze or BeCu
- Fully enclosed

3 Crimp Sleeve

- Interior precision step

Benefits:

Center Contact Benefits:

- Insures correct center contact location during outer braid crimp operation.
- Tactile feedback for error free installation.
- Eliminates pistoning of contact over product life.
- Exceptional electrical conductivity and durability for long life.

Outer Contact Benefits:

- Combination of high conductivity, ductility, and mechanical durability extended field conditions.
- Extremely high strength alloy which resists compression set over time, maintaining high contact normal forces.
- Reduces RF leakage.

Crimp Sleeve Benefits:

- Eliminates potential for exposed braid by positive grip on cable jacket for excellent cable retention over time.

75 OHM UPL2000 DIGITAL VIDEO BNC

HDTV TRANSMISSION LINE NETWORK PRODUCT SOLUTIONS - ALL TRUE 75 OHM

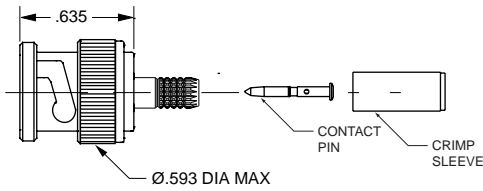

HDTV BNC
UPL2000-(Cable Group)/B

Can only be ordered in bulk packs of 50.
See Cable Groups on page 22.



Ordering Example:

sample part # **UPLR2000-D2/B**
Broadcast BNC _____
Cable Group Dash Number _____
Bulk Pack (50) _____

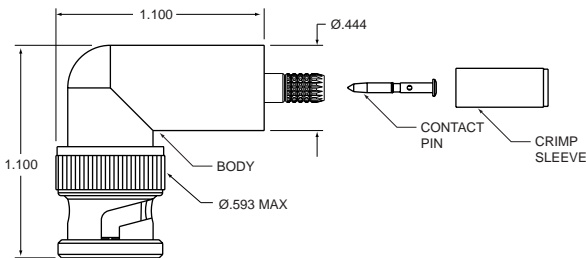

90° HDTV BNC
UPLR2000-(Cable Group)/B

Can only be ordered in bulk packs of 50.
See Cable Groups on page 22.

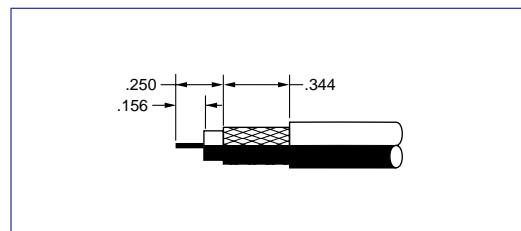

SCALE 1:1
USE AS STRIPPING
TEMPLATE FOR 75 OHM TOOL CRIMP BNC PLUG

Note: Dimension .156 inches is a minimum, the maximum is .175 inches. Either dimension, or anything in between, works fine with the 8 point tool recommended by Trompeter for Broadcast applications. If you are using a 12 point indenter tool in lieu of the more classic 8 point tool, we recommend you use the longer dimension.

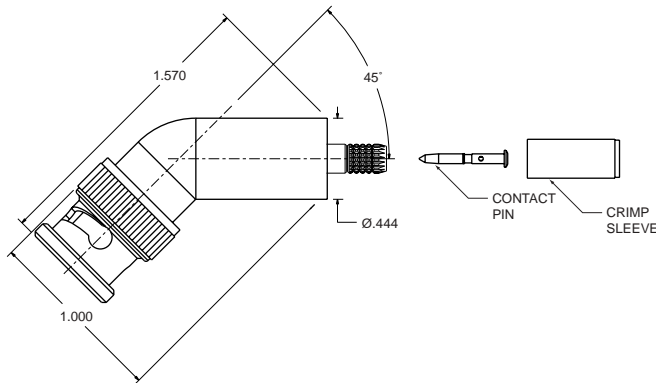

45° HDTV BNC
UPLFF2000-(Cable Group)/B

Can only be ordered in bulk packs of 50.
See Cable Groups on page 22.

**Mechanical Pull Test Criteria
Cable Retention UPL2000**

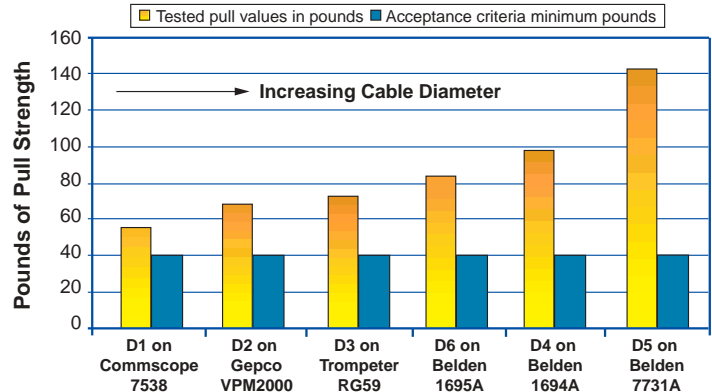

75 OHM UPL2000 DIGITAL VIDEO BNC CABLES

HDTV TRANSMISSION LINE NETWORK PRODUCT SOLUTIONS - ALL TRUE 75 OHM

UPL2000 CABLE GROUPS

CABLE MANUFACTURER	CABLE NO.	UPL2000	CABLE MANUFACTURER	CABLE NO.	UPL2000	CABLE MANUFACTURER	CABLE NO.	UPL2000
ALPHA	8620	-D4	CANARE	5C2VS	-D10	DELCO	396121	-D1
ALPHA	9059	-D3	CANARE	L-3C2VS	-D9	DELCO	396191	-D1
ALPHA	9825C	-D5	CANARE	L-3CFB	-D14	DRAKA	0.6/3.7	-D14
AVAYA	1725B	-D13	CANARE	L-4CFB	-D2	DRAKA	IMAGE720	-D9
BELDEN	1152A	-D15	CANARE	L-5CFB	105-2148	DRAKE	IMAGE1000	-D4
BELDEN	1153A	-D5	CANARE	LV-61S	-D3	ECS	322401	-25A
BELDEN	1164B	-D1	CANARE	LV-77S	-D10	EUROCABLE	LKRX75S2D4	-D1
BELDEN	1167B	-D1	CANARE	V3-1.5C	-D7	GENERAL CABLE	C5844	-D2
BELDEN	1263A	-D1	CANARE	V3-4CFB	-D8	GENERAL CABLE	LL79301	-D8
BELDEN	1406B	-D1	CANARE	V3-5C	-D6	GENERAL WIRE	C5025	-D5
BELDEN	1407B	-D1	CANARE	V4-1.5C	-D7	GEPCO	2279K	-D6
BELDEN	1417B	-D1	CANARE	V4-4CFB	-D8	GEPCO	2279V	-D6
BELDEN	1418B	-D1	CANARE	V4-5C	-D6	GEPCO	2297V	-D6
BELDEN	1426A	-D2	CANARE	V5-1.5C	-D7	GEPCO	7537	-D1
BELDEN	1505A	-D2	CANARE	V5-4CFB	-D8	GEPCO	7538	-D1
BELDEN	1505F	-D20	CANARE	V5-5C	-D6	GEPCO	7913	-D5
BELDEN	1506A	-D8	CANFORD	36-332 VCM RED	105-2145	GEPCO	7915	-D5
BELDEN	1520A	-D7	CANFORD VIDEO	BBC PSF1/2M	D10	GEPCO	RGB6000	-D10
BELDEN	1521A	-D7	CANFORD VIDEO	BBC PSF1/3M	D17	GEPCO	RGB809	-D1
BELDEN	1522A	-D7	COLEMAN CABLE	92005	-D3	GEPCO	RGBS809	-D1
BELDEN	1523A	-D5	COMMSCOPE	2065V	-D8	GEPCO	RGBSC809	-D1
BELDEN	1530A	-D4	COMMSCOPE	2277K	-D6	GEPCO	V618J59	-D3
BELDEN	1672A	-D7	COMMSCOPE	2277V	-D6	GEPCO	V618M59	-D3
BELDEN	1694A	-D4	COMMSCOPE	2279K	-D6	GEPCO	VDFM809	-D1
BELDEN	1695A	-D6	COMMSCOPE	2279V	-D6	GEPCO	VFM809	-D1
BELDEN	1807A	-D7	COMMSCOPE	2282K	-D16	GEPCO	VP6000	-D10
BELDEN	1808A	-D7	COMMSCOPE	2285K	-D16	GEPCO	VP618PE/AP	-D10
BELDEN	1824A	-D8	COMMSCOPE	2286K	-D16	GEPCO	VP618PE01	-D10
BELDEN	1825A	-D8	COMMSCOPE	5065	D1	GEPCO	VP618PVC	-D10
BELDEN	1826A	-D8	COMMSCOPE	5553	-D2	GEPCO	VPM1000	-D3
BELDEN	1828A	-D4	COMMSCOPE	5563	-D3	GEPCO	VPM2000	-D2
BELDEN	1829A	-D4	COMMSCOPE	5565	-D2	GEPCO	VPM2000TK	-D8
BELDEN	1855A	-D19	COMMSCOPE	556510	-D2	GEPCO	VPM2000TS	-D8
BELDEN	1865A	-D1	COMMSCOPE	5575	-D2	GEPCO	VPM618	-D14
BELDEN	543945	-D11	COMMSCOPE	5726R	-D4	GEPCO	VS102000	-D2
BELDEN	633948	-D6	COMMSCOPE	5765	-D4	GEPCO	VSD2001	-D4
BELDEN	7700A	-D7	COMMSCOPE	576503	-D4	GEPCO	VSM618	-D1
BELDEN	7710A	-D4	COMMSCOPE	576504	-D4	GORE	GSC 03-2236-00	-D7
BELDEN	7713A	-D4	COMMSCOPE	576505	-D4	HAN WEI	RG 179	-D7
BELDEN	7731A	-D5	COMMSCOPE	5903	-D5	HAN WEI	RG 59	-D3
BELDEN	7732A	-D16	COMMSCOPE	5904	-D5	IN-LINE	7100	-D12
BELDEN	7794A	-D11	COMMSCOPE	5906	-D5	IN-LINE	7600	-D12
BELDEN	7855A	-D13	COMMSCOPE	5913	-D5	JUDD	740	-D7
BELDEN	8212	-D2	COMMSCOPE	5915	-D5	LINK	CVS LKRX75S2D4	-D1
BELDEN	8213	-D5	COMMSCOPE	5916	-D5	MANHATTAN	M4243	-D7
BELDEN	8218	-D1	COMMSCOPE	5917	-D5	MIL-SPEC	M17/29-RG59	-D3
BELDEN	8221	-D3	COMMSCOPE	5940	-D5	MIL-SPEC	RG179/U	-D7
BELDEN	82248	-D6	COMMSCOPE	5951	-D5	MIL-SPEC	RG59B/U	-D3
BELDEN	82259	-D8	COMMSCOPE	7501	-D10	MOHAWK	M52210	-D10
BELDEN	8241	-D3	COMMSCOPE	7503	-D10	MOHAWK	M54426	-D1
BELDEN	8241A	-D3	COMMSCOPE	7505	-D10	MONTRÖSE	IFX4385	-D7
BELDEN	8241B	-D3	COMMSCOPE	7506	-D10	NEK CABLE	NEK 23795	-D12
BELDEN	8263	-D3	COMMSCOPE	7530	-D13	NK NETWORKS	0.51/2.4	-D1
BELDEN	8279	-D14	COMMSCOPE	7536	-D1	NK NETWORKS	0.6/2.8	-D12
BELDEN	8281	-D10	COMMSCOPE	753603	-D1	NK NETWORKS	0.6/3.7	-D17
BELDEN	8281B	-D10	COMMSCOPE	753604	-D1	NK NETWORKS	0.6/3.7 DZ	-D17
BELDEN	8281F	-D10	COMMSCOPE	753605	-D1	NK NETWORKS	0.6L/3.7	-D3
BELDEN	89292	-D16	COMMSCOPE	7537	-D1	NK NETWORKS	0.8/4.9	-D10
BELDEN	9011	-D5	COMMSCOPE	7538	-D1	PKI	0.6/2.8	-D12
BELDEN	9100	-D2	COMMSCOPE	7551	-D4	RAYDEX/CDT	RA7000	-D12
BELDEN	9110	-D2	COMMSCOPE	7573	-D14	SUHNER	S02223	-D7
BELDEN	9114	-D4	COMMSCOPE	F1160BV	-D5	TIMES	2360V	-D4
BELDEN	9141	-D10	COMMSCOPE	F1160BVV	-D5	TIMES	LMR195	-E1
BELDEN	9167	-D2	COMMSCOPE	F59 HEC-2	-D15	TVA	F660BVV	-D4
BELDEN	9170	-D1	COMMSCOPE	F660BVV	-D4	UNK	VCB 100	-D13
BELDEN	9209	-D9	COMMSCOPE	HEC-2	-D15	UNK	VCB 75	-D11
BELDEN	9209A	-D9	COMMSCOPE	S59 HEC	-D18	VIDEOKABEL	0.6/3.7	-D14
BELDEN	9221	-D7	COMMSCOPE	VDM230	-D1	WEST PENN	25806	-D6
BELDEN	9231	-D10	COMMSCOPE NETWORK CABLE	73608 8/30 AWG	-007 SPC	WEST PENN	25806	-D6
BELDEN	9240	-D2	COMPREHENSIVE VIDEO	CVC-59STXF	-D11	WEST PENN	HD825	-D1
BELDEN	9244	-D3				WEST PENN CABLE	818	-D2
BELDEN	9248	-D4				WEST PENN WIRE	6350	-D4
BELDEN	9259	-D11				WESTPENN	25821	-D16
BELDEN	9265	-D2						
BELDEN	9274	-D2						
BELDEN	9275	-D2						
BELDEN	9292	-D5						
BELDEN	9764	-D5						
BELDEN	YR28314	-D1						
BELDEN	YR46400	-D2						
BRYANT BROADCAST	BDS01	-D12						

If you do not see your cable listed, contact Trompeter for assistance.

PRECISION LOAD TERMINATION BNC

HDTV TRANSMISSION LINE NETWORK PRODUCT SOLUTIONS - ALL TRUE 75 OHM

UTNA2000

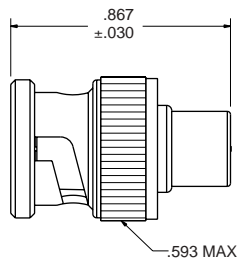

FEATURES

- 75 ohm load
- -30 dB at 3 GHz
- Horizontal noise level over entire bandwidth
- Low profile

The Trompeter UTNA2000 is a precision load of 75 ohms built into a high performance BNC plug. This enables precision return loss testing and successfully terminates a BNC jack.

UTNA2000 Return Loss Test Data

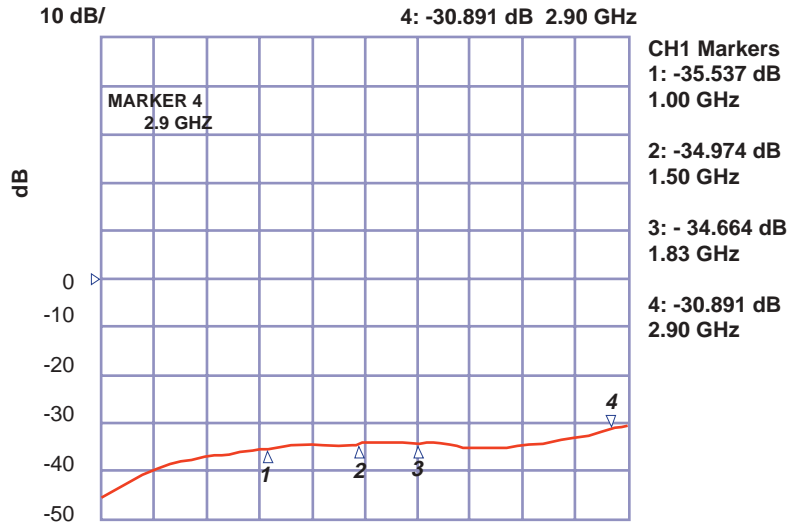

DIALOG BOX

FLAGGING

Installing the center pin on an RF connectors seems simple enough. Simply crimp the contact with any crimp tool and you are good to go, Right? Wrong!

There are two ways to attach a center contact to the center conductor of a coax cable. The first is to use a standard hex die from any of a number of manufacturers - simply ensure that the cavity is the correct size for the given cable. The other method is an indenting tool which actually bonds the center pin to the conductor.

Taking a closer look at the hex die method, the die closure is generally aligned either to the best of the installers ability or by an alignment pin. Both methods, at best, get the closure close to being in alignment. Beware: a phenomenon occurs when using the hex die know as "flagging".

When the die begins to close, it will deform the center pin into the hex shape, however, there will be a slight amount of material movement that will creep into the areas where the dies come together. On a horizontal crimper, it will tend to creep out of both sides of the die. On a pivot crimper, the material tends to only flag on the side furthest away from the pivot point. This excess material changes the ideal shape of the center

pin and can possibly deform the dielectric when the connector is assembled. The result of this, or any change to the intended structure of a connector, will be degraded return loss. Also, the hex crimp merely grips the center contact, thereby not yielding a gas tight bond, and leaving room for potential corrosion between the contact pin and center conductor. Hence more degradation of the return loss.

The indenting method actually puts 8 or 12 small indents into the center contact pin (depending on the model), forming gas tight bonds between the center pin and the center conductor. These bonds result in improved return loss characteristics, improved holding force, and prevention of any type of deposit which could lead as an initiation site for corrosion.

In the world of high frequency (usually defined as >1GHz), this issue has become an important one. As bandwidth increases, reliability become more critical, and equipment is being pushed to its limit. By heeding this advice, your connectors will attain maximum transluence to your signal flow.



CARRIER CLASS HIGH FREQUENCY "F" CONNECTORS

HDTV TRANSMISSION LINE NETWORK PRODUCT SOLUTIONS - ALL TRUE 75 OHM

BNC TO MALE "F" ADAPTER

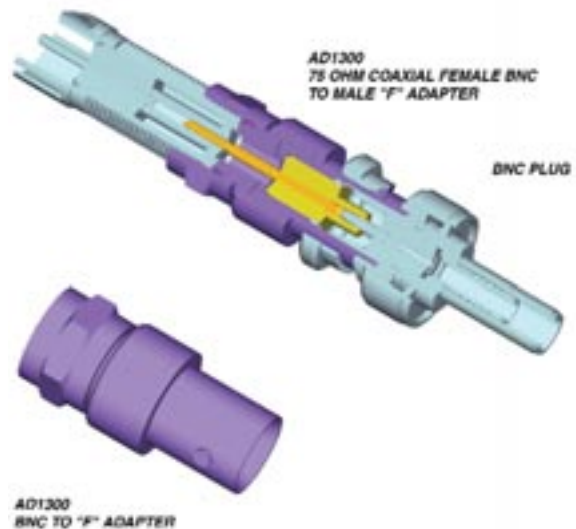

AD1300
BNC TO "F" ADAPTER

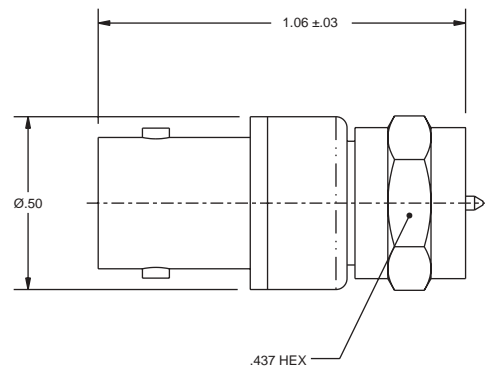

AD1300
Between Series 75 Ohm Coaxial
Female BNC to Male "F" Adapter

The connector solution for CATV appliances! Whether you are dealing with a set-top box or a cable modem, convert your problem F connector jack to a BNC at the jack or socket and enable Carrier Class performance. Face it, the single largest technical problem with the HFC deliver network used by cable TV service providers is the F connector. The F was selected back when CATV was one way residential only entertainment delivery system for television. Today, that same network has been "closed up" to handle internet two-way data flow and has been tasked to enable all the important transactions that go with home internet connectivity including monetary transfers and stock purchase transactions. The HFC CATV network, in accepting the same QoS service levels of the telephone industry (Carrier Class reliability = 99.999% uptime). What better way than to convert from the F connector to the Telco standard connector, the Trompeter BNC series? This is enabled by using the Trompeter AD1300 between series adapter (photo above), which converts your F jack into a BNC jack at the device.

DIALOG BOX

So what is wrong with the traditional F connector series as deployed in most CATV networks? What features of the garden-variety F stand in the way of Carrier Class performance in the HFC network?

Let us review:

If no center pin is used, the contact is the center wire of the wire itself

- This is either totally unplated or is plated with metals that were not designed to provide good mating surface
- This center wire is of diameter to match the other characteristics of the cable for 75 ohm performance. The F specification allows for a wire diameter for the center conductor to be 0.022 to 0.052 inches - a range that, when mated to a female socket, is not appropriate for impedance matching for higher frequency.
- Further, when a large diameter wire is used and is then followed by a smaller diameter wire, the socket is distorted by the larger wire diameter and no longer makes intimate contact with the smaller wire.

In addition, the F connector uses a threaded coupling sleeve to ensure ground. In conditions of temperature excursions, threaded connectors have a tendency to work loose due to differing coefficients of thermal expansion caused the jack usually being attached to a heat sink or a heat source. Fortunately, all these problems and drawbacks of the traditional HFC network can be overcome by using this adaptor at the appliance and Telco industry standard BNC connectors for the rest of the wiring assignment. At Trompeter, our job isn't done until Carrier Class performance is achieved!

CARRIER CLASS HIGH FREQUENCY “F” CONNECTORS

HDTV TRANSMISSION LINE NETWORK PRODUCT SOLUTIONS—ALL TRUE 75 OHM

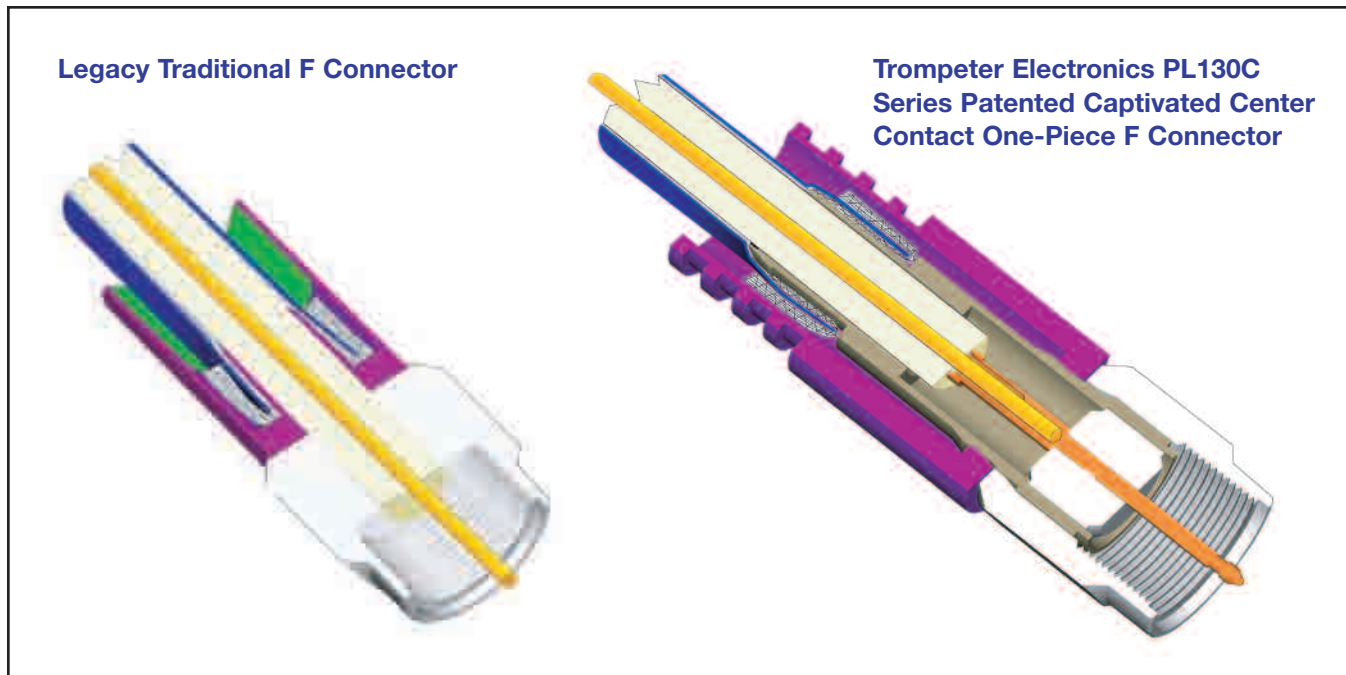

APPLICATION NOTES:

With conventional “F” connector designs that utilize the center wire itself as the male mating contact, the variation caused by diverse wire diameters can contribute to bit errors in the signal transmission. With our innovative designs, Trompeter is providing the market with a top-of-the-line connector to match the quality of electrical clarity and rugged performance you have come to expect from Trompeter. This design sets a new standard for the “F” connector in broadband applications (headend applications, cable TV set-top boxes, cable modem for Internet connectivity, and Hybrid Fiber Coax networks in general).

CARRIER CLASS HIGH FREQUENCY "F" CONNECTORS

HDTV TRANSMISSION LINE NETWORK PRODUCT SOLUTIONS - ALL TRUE 75 OHM

THREE - PIECE "F" CONNECTORS

Trompeter Electronics announces the addition of a new high performance 90 degree F connector for wireless data applications. The right angle configuration of this F connector accommodates situations where space constraint is problematic, and allows for increased connector density in a given area.

The new PLR130SC delivers excellent frequency response over an extended bandwidth, and can be assembled to any standard coax cable using standard Trompeter installation tools.

PLR130SC-(Dash No. from Chart Below) 75 Ohm Right Angle "F" style Full Crimp Cable Plug

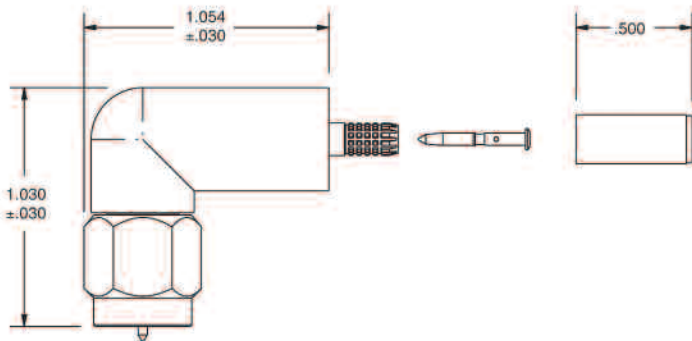

PL130SC-(Dash No. From Chart) 75 Ohm "F" Type Tool Crimp Plug

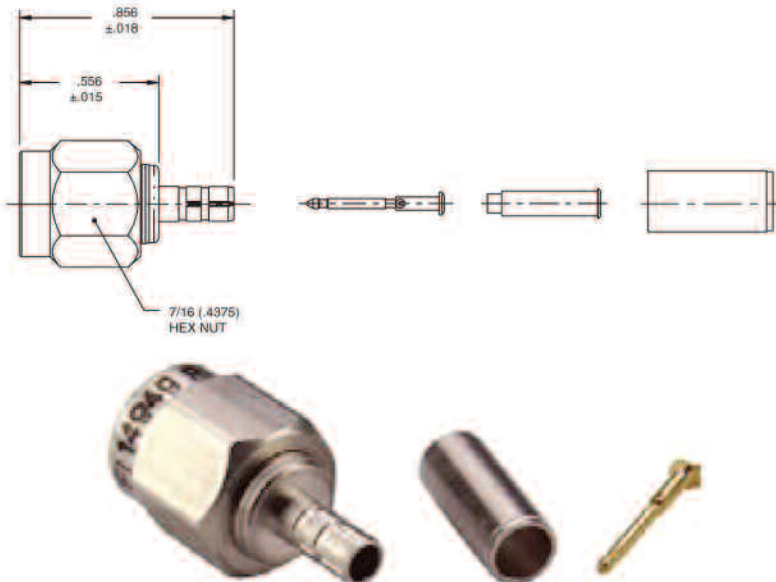

These parts use traditional crimp/crimp installation tools developed by Trompeter. See www.trompeter.com

DASH NO.	CABLES ACCOMMODATED	A HEX
-001	RG-178, -196	.178
-002	HEWLETT PACKARD 8120 - 1107	.197
-003	RG-174, 316	.178
-004	RG-179, 187	.178
-005	NORTHERN ELECTRIC DBL - SHLD RG-187	.197
-006	GC875GPI, GRUMMAN DBL - SHLD RG-188	.197
-007	275-3991, MICRODOT	.178
-008	RG-195, -180 421-111, ESSEX	.178
-009	8218, BELDEN YR23023 BELDEN 21-597, ESSEX	.178
-011	RG-58, RG-141, RG-303, TCC-50-2	.213
-013	RG-59	.255
-013A	TCC-75-2	.255
-013B	RG-62	.255
-014	8212, BELDEN	.255
-015	730A, LUCENT	.290
-015A	RG-71	.290
-016	724, LUCENT 8281, BELDEN	.324
-017	RG-6	.344
-018	9268, BELDEN	.255
-019	8279, BELDEN	.255
-020	9248, BELDEN	.290
-021	88240, BELDEN	.213
-022	88241, 88269, BELDEN	.255
-023	89108, BELDEN	.255
-024	89120, BELDEN	.290
-025	734A, LUCENT	.255
-026	735A, LUCENT	.178
-027	KS19224L2, LUCENT	.178

Reference cables, call factory for other cable options



CARRIER CLASS HIGH FREQUENCY "F" CONNECTORS

HDIV TRANSMISSION LINE NETWORK PRODUCT SOLUTIONS - ALL THRU 75 OHM

PRINTED CIRCUIT BOARD EDGE MOUNT "F" CONNECTORS

Trompeter offers a wide range of F connector series products, including a new edge-mount circuit board F-connector, the CBJE130. The unique design of this new connector features a center pin in-line with the plane of the board for superior signal integrity. This side launch design approach also features a much lower profile than standard right angle jacks, for reduced board space requirements. The CBJE130 was designed for applications such as broadcast and cable box products and is part of the new high frequency PCB coax connector series featured in the PCB Design Guide from Trompeter.

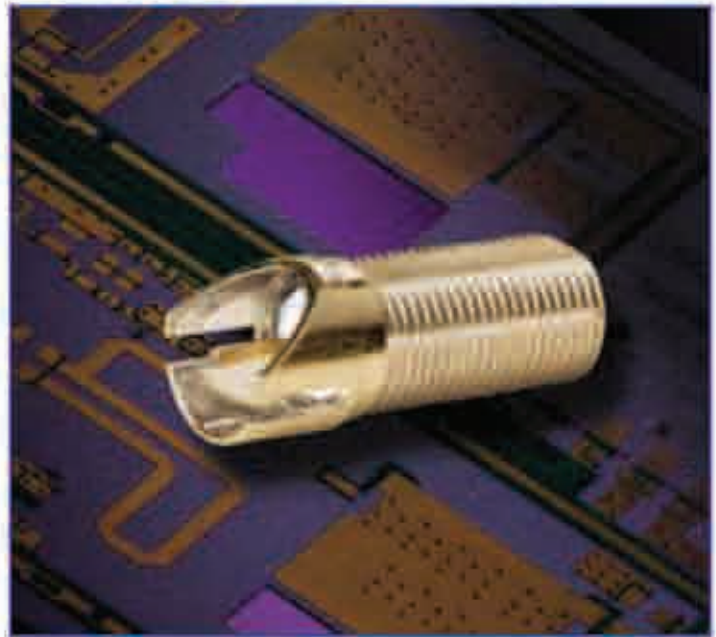

CBJE130-1 or -2 Circuit Board Edge Mount "F" Style Female Jack

PART NO	BOARD THICKNESS
CBJE130-1	.090 - .094
CBJE130-2	.078 - .083
CBJE130-3	.090 - .094

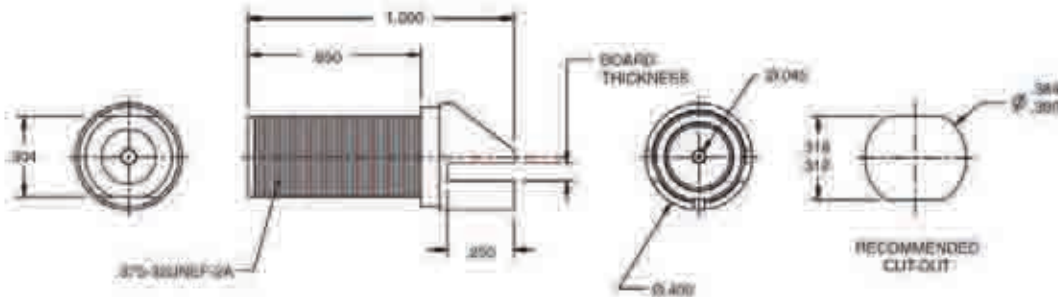

CBPLE130-1,-2, or -3 Circuit Board Edge Mount "F" Style Male Plug

PART NO	BOARD THICKNESS
CBPLE130-1	.090 - .094
CBPLE130-2	.078 - .083
CBPLE130-3	.090 - .094

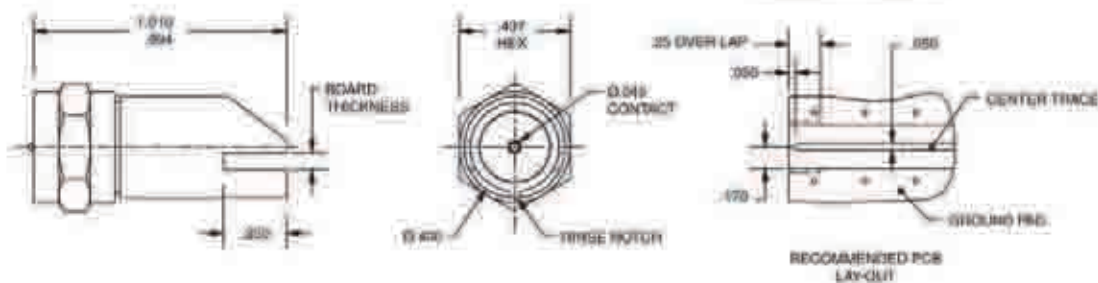

BNC INSTALLATION TRAINING

HDTV TRANSMISSION LINE NETWORK PRODUCT SOLUTIONS - ALL TRUE 75 OHM

DIALOG BOX

DOUBLE CRIMPING

The assembly of a BNC connector on coax cable is a critical, and often overlooked, part of any installation. There are a wide variety of BNC's available on the market today, with a corresponding variation in installation methods. While the BNC is easily installed, there are also many ways to unintentionally damage it that don't meet the eye.

As a critical part of an RF signal path, the BNC needs to be both mechanically sound and electronically invisible to the signal. While a good mechanically strong installation is important, it is also critical not to deform the interconnect path such as to impede or alter the RF path.

When applying a hex crimp to the BNC sleeve, many installers double crimp the sleeve to either ensure a good mechanical bond, or from necessity because their tool will not crimp the entire sleeve in one pass. Neither situation is acceptable.

A connector that has been double crimped can always be spotted in a completed installation by an indented ring around the crimp sleeve close to the center of the sleeve (depending on die placement). In addition to electrical degradation that occurs from the double crimp, a much more obvious drawback is that it requires twice the time, reducing productivity.

First and foremost, always use the proper tool for the connector type. This ensures a good mechanical bond and a superior electrical performance. However even with the correct tool, a double crimp should never be performed! When a secondary crimp is made, it causes the crimp sleeve closest to the body to rise and causes separation between the crimp sleeve, the braid, and the ferrule. While the separation is small, difficult to discern, and has a minimal effect on the mechanical retention, this separation can result in poor return loss performance in the connector. If the initial crimp was inadequate for whatever reason, the connector should be removed and a new connector installed.

When the initial crimp is made, the crimp sleeve should be firmly placed against the body of the connector, and the sleeve compressed into the cable. The cable in turn is held firmly against the ferrule, giving a good mechanical bond for strength and a direct path for the signal.

Remembering that "the best connector is no connector at all", it is important to minimize the impact that the connector brings to the system. Proper tools and techniques save time, money, and yield superior performance.

BNC TRAINING / BNC ASSEMBLY VIDEO

Trompeter has provided BNC installation training for several decades, free of charge if Trompeter BNC's are used by the installers. Our on-site training program results in fully trained and certified installers (see example this page). In addition, Trompeter offers a VHS video tape or CD for remote or "refresher" training. For larger organizations that wish to provide this on their own, we have a fully documented Train-the-Trainer program as well. Call us for details!



CABLE STRIPPING TOOLS

HDTV TRANSMISSION LINE NETWORK PRODUCT SOLUTIONS - ALL TRUE 75 OHM



POWER STRIPPER - 1 YEAR WARRANTY

This powerful, low-cost, portable hand-held (less than 2.25 lbs.) cable stripper delivers production quality performance. The replaceable 3-level cutter head is preset to strip your coax cable for Trompeter's UPL2000 series, tool crimp BNC Connectors. The cutter head has adjustable depth cutter blades for precision tuning. Precision ground, tool steel blades (hardened to Rockwell 64) give you up to 15,000 strips! Battery life is rated at 250 strips per charge and the Rapid Charger/Reconditioner recharges your Ni-Cad in only 1.5 hours!



"The 3-level cutter heads included in the kits above are set to the same stripping dimensions as our STC-F stripping cassette (see below) for Trompeter BNC "Tool Crimp" cable connectors.

POWERED CABLE STRIPPER KITS

Comes with: 1 Drive, 1 Ni-Cad Battery Pak, 1 Cutter Head, 1 Rapid Charger/Reconditioner and: 1 Carrying Case.

For Cables: RG-59, 1505
For Cables: 8281, 1694

Kit Part Number
Stripper/Cutter Head
BCWS/C26T3D
BCWS/C26T3I

ADDITIONAL ACCESSORIES

For Extra Cutter Heads: See **Cutter Head Guide**.
Extra Drivers:

- BWS** DC Driver - Requires cutter head from below
- AWS** AC Driver - Requires cutter head from below
- BWCC-NSA** Rapid Charger / Reconditioner
- EBP** Ni-Cad Battery Pak
- AWC** AC Power Converter
- BWC** AC Charger Cord
- DWC** Auto 12V DC Charger
- BWS-EB** Extra Ni-Cad Battery (only)
- AWS-BWS-EC** End Caps

UPL2000-(DASH NO)

DASH NO	CABLE NAME	ODD/OUTSIDE DIA (IN)	STRIPPING HEAD (CUT)
D1	CommScope 750E	.163	C26T3I
D2	Belden 1585A	.255	C26T3D
	Gasco VPM2000	.262	C26T3D
D3	RG-59/U	.242	C26T3D
D4	Belden 1694/1694I	.275	C26T3U
	Gasco V5D2001	.273	C26T3U
D5	Belden 7731A	.405	C26T3E
	CommScope 5906	.405	C26T3E
D6	Belden 1695A	.236	C26T3D
D7	Belden 9221	.166	C26T3A
	RG175	.165	C26T3A
D8	Belden 1586A	.301	C26T3C
	Gasco VPM2000TK	.300	C26T3C
D9	Belden 9209	.300	C26T3C
D10	Belden 8281	.307	C26T3E
D11	Western 25815	.214	C26T3C
D12	Nokia 0.6/0.8	.213	C26T3B
D13	CommScope F530	.318	C26T3E
D14	Belden 8279	.220	C26T3C
D15	CommScope FR5HEC	.269	C26T3D
D16	Belden 7732A	.356	C26T3E
	CommScope 2285	.355	C26T3E
D17	NK Networks 0.6/3.7	.300	C26T3D
D18	CommScope 558HEC	.369	C26T3D
D19	Belden 1855A	.158	C26T3I
D20	Belden 1505F	.242	C26T3D
D21	VDM230	.171	C26T3B

Cutter Head Guide

C26T3A	.070-110
C26T3B	.160-215
C26T3C	.190-230
C26T3D	.235-270
C26T3E	.300-430
C26T3I	.110-160
C26T3U	.271-305

MANUAL CABLE STRIPPING TOOLS



CABLE CUTTING TOOL

700-0024

Designed to cut coax cables without compressing dielectric or damaging center conductor.



HAND CABLE STRIPPING TOOL

Cable Range: 10-30"

- ST1** Tool only - Requires blade cassette listed
- STC-F** Cassette - Green (For tool crimp BNC connectors)

CRIMPING TOOLS

HDTV TRANSMISSION LINE NETWORK PRODUCT SOLUTIONS - ALL TRUE 75 OHM

CENTER CONTACT CRIMP TOOL



8-Point Crimp Tool

75 Ohm Center Contact Pin	
BNC/Patch Plug (Red/Blue Handle)	010-0097
BNC Jack (Blue Handle)	010-0088

12-Point Crimp Tool

75 Ohm Center Contact Pin	
BNC/TNC (Yellow Handle)	010-0080
BNC/TNC/Patch Plug (Green/Yellow Handle)	010-0098

CRIMP TOOL AND CRIMP DIES



CT4L

Frame only
(Die not included, for crimp dies see chart)

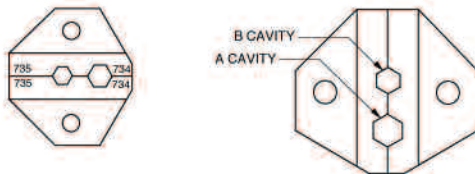

CRIMP DIES

75 Ohm Outer Sleeve

	A EMBOSSES		B EMBOSSES	
CD3-1	.213	1A	.178	1B
CD3-2	.324	2A	.255	2B
CD3-3	.344	3A	.290	3B
CD3-21	.290	290	.255	255
CD3-22	.404	404	.068	

Note: Dies imprint either cavity (A/B) or hex size onto crimp sleeve. Custom dies are available for special imprints.

*010-0055 or other center pin crimp tool required.

UPL2000-(Dash Number)

DASH NO.	CRIMP SLEEVE			CENTER CONTACT	
	HEX SIZE	DIE SET NUMBER	CAVITY POSITION	CAVITY POSITION	OPTIONAL CENTER CONTACT CRIMP TOOL (RECOMMENDED)
D1	.178	CD3-1	B	D	010-0098
D2	.255	CD3-21	B	C	010-0098
D3	.255	CD3-21	B	C	010-0098
D4	.290	CD3-21	A	C	010-0098
D5	.403	CD3-22	A	B	See Below
D6	.290	CD3-21	A	C	010-0098
D7	.178	CD3-1	B	D	010-0098
D8	.255	CD3-21	B	C	010-0098
D9	.255	CD3-21	B	C	010-0098
D10	.324	CD3-2	A	D	010-0098
D11	.255	CD3-21	B	C	010-0098
D12	.213	CD3-1	A	D	010-0098
D13	.344	CD3-3	A	C	010-0098
D14	.255	CD3-21	B	C	010-0098
D15	.290	CD3-21	A	C	010-0098
D16	.403	CD3-22	A	B	-
D17	.290	CD3-21	A	C	010-0098
D18	.290	CD3-21	A	C	010-0098
D19	.213	CD3-1	A	D	010-0098
D20	.255	CD3-21	B	C	010-0098
D21	.213	CD3-1	A	D	010-0098

TOOL: TROMPETER CRIMP TOOL CT4L WITH DIE SET NO. (See Above)

For D5: Crimp center contact using M22520/1-01 handle setting 6 with Positioner 010-0045.

DIALOG BOX

CENTER CONTACT - MULTIPOINT INDENTOR VS HEX CRIMPING

As frequencies rise and digital information flows, the need for a more intimate metal-to-metal contact area becomes important. Multipoint indenting with a special tool will need to replace the old "analog" broadcast market practice of using hex die crimping for the center contact itself. Trompeter strongly recommends the use of a multipoint indenter tool for crimping the center contact of video BNC connectors. Hex crimping provides good surface area but doesn't actually "move metal" to achieve the interconnect.



BNC TOOLS

HDTV TRANSMISSION LINE NETWORK PRODUCT SOLUTIONS—ALL TRUE 75 OHM

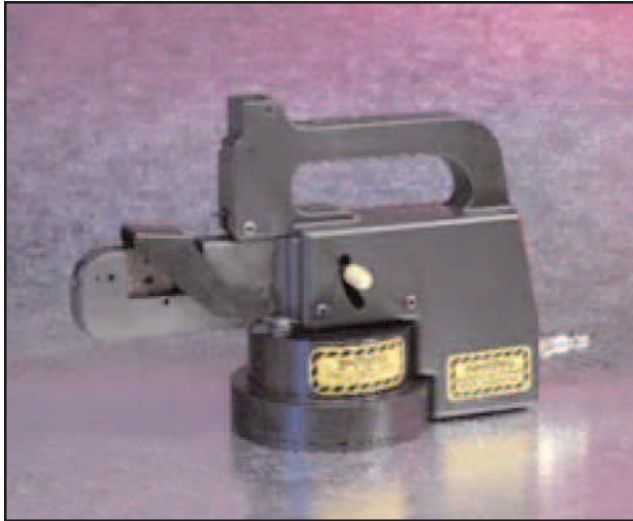

BENCHTOP CRIMP TOOL **CTB-1/CD5A-2**

Manufactured to Trompeter engineering specifications. It is designed for production crimping assignments for coaxial cable connectors such as the BNC series. The base unit include a foot switch and one pair of self-aligning parallel hex dies as standard equipment. Ships with our CD5A-2.

BROADCAST DIE **CD5A-2**

Manufactured to Trompeter engineering specifications and designed with the most popular crimp hex sleeve found in broadcast connectors; .255" and .290".



BNC COAX TESTER...

Designed to test for the proper assembly of BNC plugs with coax cables. Tests for center contact pin height and continuity (short or open). Mini-WECO continuity test adapter can be ordered (sold separately).

- Compact design
- Pass/Open/Short LED indicators
- One test required for testing remote cable runs
- Easy to follow instructions
- Complete with terminators, case and 9V battery

010-0133

Coax Cable Assembly Connector
Test Set
75 Ohm BNC Plugs

105-1885

Mini-WECO Adapter: Continuity
Test Sold Separately

BNC/TNC REMOVAL TOOLS



All these removal tools are available with an insulated shaft—call factory and ask for the “blue one”.

CONNECTOR REMOVAL TOOLS

PART NO.	BNC/TNC CABLE PLUG TYPE	LENGTH
RT1XL	STRAIGHT	22.00"
RT1L	STRAIGHT	12.00"
RT1S	STRAIGHT	6.00"
RT1SS	STRAIGHT	3.75"
RTR-1L*	RIGHT ANGLE	12.00"
RTR-1XL	RIGHT ANGLE	22.00"

*For the HDVDPMT jacks, the RTR-1L should be used due to the proximity of adjacent jacks.

HDTV GLOSSARY

HDTV TRANSMISSION LINE NETWORK PRODUCT SOLUTIONS - ALL TRUE 75 OHM

4:2:2	A commonly used term for a component digital video format. A ratio of sampling frequencies used to digitize the luminance and color difference components (Y, R-Y, B-Y) of a video signal. It is generally used as shorthand for ITU-R 601. The term 4:2:2 describes that for every four samples of Y, there are two samples each of R-Y and B-Y, giving more chrominance bandwidth in relation to luminance compared to 4:1:1 sampling.
ATSC:	Advanced Television Systems Committee Committee responsible for DTV standards and development.
ADC (A-D, A/D, A-to-D):	Analog to Digital Conversion. Also referred to as digitization or quantization. The conversion of an analog signal into the digital data representation of that signal-normally for subsequent use in a digital machine. For TV, samples of audio and video are taken, the accuracy of the process depending on both the sampling frequency and the resolution of the analog amplitude information-how many bits are used to describe the analog levels. For TV pictures eight or 10-bits are normally used; for sound, 16 or 20-bits are common, and 24-bits are being introduced. The ITU-R 601 standard defines the sampling of video components based on 13.5 MHz, and AES/EBU defines sampling of 44.1 and 48 kHz for audio. For pictures, the samples are called pixels, each containing data for brightness and color. See also: Binary, Bit.
Analog:	<ol style="list-style-type: none">1. An adjective describing any signal that varies continuously as opposed to a digital signal, which contains discrete levels.2. A system or device that operates primarily on analog signals.
ASCII:	American Standard Code for Information Interchange. A standard code for transmitting data, consisting of 128 letters, numerals, symbols, and special codes each of which is represented by a unique binary number.
Aspect ratio:	The ratio of television picture width to height. In NTSC and PAL video, the present standard is 4:3. In HDTV video, it is typically 16:9.
Asynchronous:	Lacking synchronization. In video, a signal is asynchronous when its timing differs from that of the system reference signal.
ATM:	Asynchronous Transfer Mode. A data transmission scheme using self-routing packets of 53 bytes, 48 of which are available for user data. Typically 25 and 155 Mbps, with 622 Mbps coming soon-the latter of which could be used to carry non-compressed ITU-R 601 video as a data file.
Bandwidth:	<ol style="list-style-type: none">1. The complete range of frequencies over which a circuit or electronic system can function with minimal signal loss, typically less than 3 dB.2. The information-carrying capability of a particular television channel. In transmission, the United States analog and digital television channel bandwidth is 6 MHz.
Baseband:	A signaling technique in which the signal is transmitted in its original form and not changed by modulation. Local Area Networks as a whole, fall into two categories: baseband and broadband. Baseband networks are simpler and cheaper; the entire bandwidth of the LAN cable is used to transmit a single digital signal. In broadband networks, the capacity of the cable is divided into channels, which can transmit many simultaneous signals. Broadband networks may transmit a mixture of digital and analog signals, as will be the case in hybrid fiber/coax interactive cable television networks.
Baud:	A unit of signaling speed equal to the number of signal events per second. Baud is equivalent to bits per second in cases where each signal event represents exactly one bit. Often the term baud rate is used informally to mean baud, referring to the specified maximum rate of data transmission along an interconnection.
Binary:	A base-2 numbering system using the digits 0 and 1 (as opposed to 10 digits [0 - 9] in the decimal system). In computer systems, the binary digits are represented by two different voltages or currents, one corresponding to 0 and the other corresponding to 1. All computer programs are executed in binary form. Binary representation requires a greater number of digits than the base 10 decimal system more commonly used. For example, the base 10 number 254 is 11111110 in binary. The result of a binary multiplication contains the sum of digits of the original numbers. So: $10101111 \times 11010100 = 1001000011101100$ (In decimal $175 \times 212 = 37,100$) (From right to left, the digits represent 1, 2, 4, 8, 16, 32, 64, 128, 256, 512, 1024, 2048, 4096, 8192, 16384, 32768) Each digit is known as a bit. This example multiplies two 8-bit numbers to produce a 16-bit result-a very common process in digital television equipment.
Cable modem:	A data modem that uses the bandwidth of a given cable system, which promise speeds of up to 80 times faster than an ISDN line or six times faster than a dedicated T1 line (the type of connection most large corporations use). Because cable modems provide Internet access over cable TV networks (which rely primarily on fiber optic or coaxial cable), they are much faster than modems that use phone lines. Bandwidths are typically up to 30 Mbps in the down stream direction.



HDTV GLOSSARY

HDTV TRANSMISSION LINE NETWORK PRODUCT SOLUTIONS - ALL TRUE 75 OHM

Cliff effect:	An RF characteristic that causes DTV reception to change dramatically with a small change in power. At the fringes of reception, current analog TV pictures degrade by becoming "snowy." With DTV, relatively small changes in received power in weak signal areas will cause the DTV picture to change from perfect to nothing and hence the name: cliff effect.
Component Video:	Our color television system starts out with three channels of information; Red, Green, & Blue (RGB). In the process of translating these channels to a single composite video signal they are often first converted to Y, R-Y, and B-Y. Both three channel systems, RGB and Y, R - Y, B - Y are component video signals. They are the components that eventually make up the composite video signal. Much higher program production quality is possible if the elements are assembled in the component domain. One of the advantages DVD has over the laser disc format is that it is component based.
Composite Video:	A single video signal that contains luminance, color, and synchronization information. NTSC, PAL, and SECAM are all examples of composite video systems.
Compression:	Reduction of the size of digital data files by removing redundant information (lossless) or removing non-critical data (lossy). Pictures are analyzed looking for redundancy and repetition and so discard unnecessary data. The techniques were primarily developed for digital transmission but have been adopted as a means of handling digital video in computers and reducing the storage demands for digital VTRs. Compression can be at either a set rate or a variable rate.
dB (decibel):	A measure of voltage, current, or power gain equal to 1/10 of a bel. Given by the equations $20 \log V_{out}/V_{in}$, $20 \log I_{out}/I_{in}$, or $10 \log P_{out}/P_{in}$.
Digital:	Circuitry in which data carrying signals are restricted to either of two voltage levels, corresponding to logic 1 or 0. A circuit that has two stable states: high or low, on or off.
Digital Television (DTV):	refers to transmitting a broadcast signal by encoding it as zeroes and ones, the digital code used in computers. DTV has many advantages. It can be compressed to provide four, five or more channels in the same bandwidth required for one channel of NTSC television (the current standard). Digital television provides a crystal clear, "snow-free" picture to all TVs that can receive a minimum level signal.
Frame:	In film or video, a frame is a complete picture. In interlaced NTSC video a frame consists of two fields. In a video disc, the word frame refers to a single picture. It can mean film picture or video picture.
Harmonics:	Integral multiples of a fundamental frequency are harmonics of that frequency. A pure Sine wave is free of harmonics. Adding harmonics to a fundamental frequency will change its wave shape. A square wave contains a fundamental frequency plus all the odd harmonics of that frequency.
HDTV:	High definition television. The 1,125-, 1,080- and 1,035-line interlace and 720 and 1,080-line progressive formats in a 16:9 aspect ratio. Officially a format is high definition if it has at least twice the horizontal and vertical resolution of the standard signal being used.
HFC:	Hybrid fiber coax. A type of network that contains both fiber-optic cables and copper coaxial cables. The fiber-optic cables carry TV signals from the head-end office to the neighborhood; the signals are then converted to electrical signals and then go to coaxial cables.
Huffman coding:	This compresses data by assigning short codes to frequently-occurring sequences and longer ones to those less frequent. Assignments are held in a Huffman Table. The more likely a sequence is to occur the shorter will be the code that replaces it. It is widely used in video compression systems where it often contributes a 2:1 reduction in data.
Interlaced:	Short for interlaced scanning. Also called line interlace. A system of video scanning whereby the odd- and even-numbered lines of a picture are transmitted consecutively as two separate interleaved fields. Interlace is a form of compression.
Jitter:	An undesirable random signal variation with respect to time.
JPEG:	Joint Photographic Experts Group. ISO/ITU-T. JPEG is a standard for the data compression of still pictures (intrafield). In particular its work has been involved with pictures coded to the ITU-R 601 standard. JPEG uses DCT and offers data compression of between two and 100 times and three levels of processing are defined: the base line, extended and "lossless" encoding.
Letterbox:	The term used to describe the way a 16:9 aspect ratio image is displayed on a 4:3 screen, where black areas are visible above and below the image.

HDTV GLOSSARY

HDTV TRANSMISSION LINE NETWORK PRODUCT SOLUTIONS - ALL TRUE 75 OHM

MPEG:	Compression standards for moving images conceived by the Motion Pictures Expert Group, an international group of industry experts set up to standardize compressed moving pictures and audio. MPEG-2 is the basis for ATSC digital television transmission. Its work follows on from that of JPEG to add interfield compression, the extra compression potentially available through similarities between successive frames of moving pictures.
MPEG-2:	This has been designed to cover a wide range of requirements from "VHS quality" all the way to HDTV through a series of algorithm "profiles" and image resolution "levels." With data rates of between 1.2 and 15 Mbps, there is intense interest in the use of MPEG-2 for the digital transmission of television-including HDTV-applications for which the system was conceived. MPEG-2 is the compression used by the ATSC and DVB standards. MPEG can offer better quality pictures at high compression ratios than pure JPEG compression, but with the complexity of decoding and especially coding and the 12-long group of pictures (GoP), it is not an ideal compression system for editing.
Nyquist frequency (Nyquist rate):	The lowest sampling frequency that can be used for analog-to-digital conversion of a signal without resulting in significant aliasing. Normally, this frequency is twice the rate of the highest frequency contained in the signal being sampled.
OC3:	Optical Carrier Level 3. A 155 Mbps ATM SONET signal stream that can carry three DS3 signals.
Pixel:	Short term for picture element, essentially a single displayable video dot.
POTVS:	Plain Old Television Service - Normal NTSC television over cable is 525i @ 30 frames per second, each channel needs 6 MHz of bandwidth, frequency range used is 54 to 550 MHz.
Progressive:	Short for progressive scanning, a system of video scanning whereby lines of a picture are transmitted consecutively, such as in the computer world. Typically used by all VGA monitors.
QAM:	Quadrature amplitude modulation. A combination of amplitude and phase. A down stream digital modulation technique that conforms to the International Telecommunications Union (ITU) standard ITU-T J. 83 Annex B which calls for 64 and 256 quadrature amplitude modulation (QAM) with concatenated trellis coded modulation, plus enhancements such as variable interleaving depth for low latency in delay sensitive applications such as data and voice. Using 64 QAM, a cable channel that today carries one analog video channel could carry 27 Mbps of information, or enough for multiple video programs. Using 256 QAM, the standard 6 MHz cable channel would carry 40 Mbps.
Resolution:	The density of lines or dots per line that make up a visual image. Usually, the higher the numbers, the sharper and more detailed the picture will be. In terms of DTV, maximum resolution refers to the number of horizontal scanning lines multiplied by the total number of pixels per line, called pixel density.
RGB:	The abbreviation for the red, green and blue signals, the primary colors of light (and television). Cameras and telecines have red, blue and green receptors, the TV screen has red, green and blue phosphors illuminated by red, green and blue guns.
Serial:	One bit at a time, along a single transmission path.
Serial digital:	Digital information that is transmitted in serial form. Often used informally to refer to serial digital television signals.
SMPTE:	(Society of Motion Picture and Television Engineers) A global organization, based in the United States, that, among other things, sets standards for baseband visual communications. This includes film as well as video standards.
SMPTE 292M:	The SMPTE standard for bit-serial digital interface for high-definition television systems.
Standard Definition Television (SDTV):	is a digital television system that is similar to current standards in picture resolution and aspect ratio. The picture and sound will be clearer than NTSC, and its digital base will allow more than one program to be broadcasted over the same bandwidth at the same time.
Wide screen:	Term given to picture displays that have a wider aspect ratio than normal. For example TV's normal aspect ratio is 4:3 and wide screen is 16:9. Although this is the aspect ratio used by HDTV, wide screen can be used with normal definition systems.



CATALOG INDEX

HDTV TRANSMISSION LINE NETWORK PRODUCT SOLUTIONS—ALL TRUE 75 OHM

PART NUMBER	PAGE(S)	PART NUMBER	PAGE(S)
010-0133	31	J315W	6
010-0080	30	J315MW	6
010-0088	30	JSMW64D	9
010-0097	30	JSMW64S	9
010-0098	30	JSMW128	9
105-1885	31	LPW-75	14
155-0852	12	MP20W	7
155-0874	12	PANELS	8-12
155-0887	12	PCMWB	16
700-0024	29	PATCH CORDS	16
AD1300	24	PL1WC	14
AD1WHD	14	PL2W	14
CABLE GROUPS	22	PL11C	15
CRIMP DIES	30	PL11SC	15
CRIMP TOOLS	30	ST1	29
CTB-1/CD5A-2	31	STC-F	29
CT4L	30	REMOVAL TOOLS	31
CUTTER HEADS	29	PL11SC	15
F CONNECTORS	24-27	TPMW-1-75	15
HOLE PLUGS	8	TPW-1-75	14
J11B/J11MW	15	UPL2000-XX	18-22
J11BL/J11MWL	15	UPLFF2000-XX	18-22
J13W-75	14	UPLR2000-XX	18-22
J24WMSTHF-75	13	UTNA2000	23
J25W	13		
J3W	14		
HDVDP	4-5		
HDVDPT	4-5		
HDVDPM	2-3		
HDVDPMT	2-3		

ISO9001 REGISTRATION

The main value of being an ISO 9001 Registered company is in the assurance to our customers that we have a solid quality system in place, and that it is well documented. DET Norske Veritas (DNV), our ISO Registrar, has certified that we are in compliance with established systems and policies. ISO 9001 Quality System Standard is a document outlining twenty elements of quality that Trompeter addressed in order to meet registration requirements. An accredited ISO 9001 auditor must verify, through on-site audits, that a company has a well documented quality system in place that meets the requirements of ISO 9001, and that the company is working in accordance with the documented system. Trompeter's Quality System is also certified by numerous other accredited agencies. ISO 9001 registration makes Trompeter more competitive in the global market by giving customers the assurance that they are dealing with a company dedicated to meeting their quality expectations.

WARRANTY

All Trompeter products carry a "Three Year Warranty" and meets or exceed the highest industrial and government standards, such as MIL-C-39012 and MIL-C-49142, which was developed from Trompeter commercial products. More importantly, Trompeter connectors are designed to meet your design specifications which are often more demanding and less forgiving. We have built our business on responding too your special needs for uncompromising performance in a world of increasing pressure from global competition. If, within three years of shipment, any of our products fail to meet your expectations due to defects in material or workmanship, we will gladly repair or replace it free of charge. For the battery powered cable stripper only a one-year warranty applies.

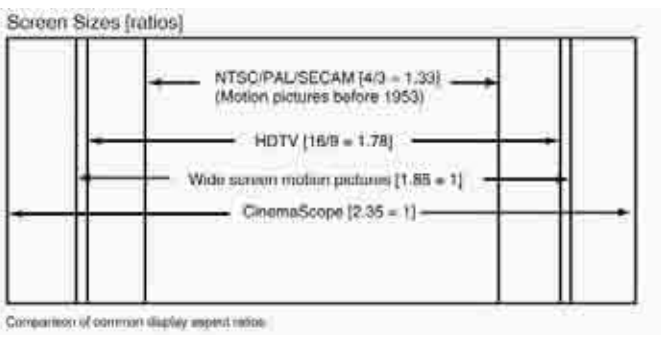

Emerson Network Power Connectivity Solutions

Trompeter
5550 E. McDowell Road
Mesa, AZ 85215
USA

Tel: 480.985.9000

Fax: 480.985.0334

www.trompeter.com

About Emerson Network Power Connectivity Solutions

Emerson Network Power Connectivity Solutions, an Emerson business, serves the needs of wireless communications, telephony and data networks, CATV, security systems, health care and industrial facilities with a full spectrum of broadband copper and fiber optic connectivity products. For more information, visit www.EmersonNetworkPower.com/Connectivity.

About Emerson

Emerson (NYSE: EMR), based in St. Louis, is a global leader in bringing technology and engineering together to provide innovative solutions to customers through its network power, process management, industrial automation, climate technologies, and appliance and tools businesses. For more information, visit www.gotoemerson.com.

Emerson Network Power.

The global leader in enabling business-critical continuity.

- AC Power Systems
- Embedded Power
- Outside Plant
- Connectivity
- Inbound Power
- Precision Cooling
- DC Power Systems
- Integrated Cabinet Solutions
- Site Monitoring and Services

www.EmersonNetworkPower.com