

TOOLS



Tools

Tools

Description

Amphenol offers a full line of termination tooling to meet your specific production requirements. All tools meet Amphenol's stringent design and quality requirements, including full cycle ratchet control, which prevents the connector from being removed from the tool prior to completing the crimping operation. Amphenol's tools provide a consistent and reliable crimp each and every time, thereby ensuring the integrity of the connector termination.

Tool Series

- Bench Mounted Pneumatic Crimp Machine
- CTL Series Crimp Tools
- Hand Crimp Tool
- ECONOHEX Crimp Tool
- MMCX CTL Crimp Tool
- CAP Installation and Connector Removal Tool

Bench Mounted Pneumatic Crimp Machine

This pneumatic-powered crimp tool makes production termination for coaxial cable easy, efficient and precise. Our compact (less than 20 pounds) unit is hand-activated. The dual-position feet allow horizontal or vertical loading for maximum efficiency. The manually-activated mode is adaptable to either right or left-hand operation. The connector/cable loading mechanism is spring loaded to help keep hands away from the work area during the crimp cycle. The die holder is compatible with industry standard die sets from Connex, Ideal Industries, Paladin and Sargent. The adjustable crimp height allows for termination of coaxial cable, as well as discrete wire terminations, with appropriate dies for custom crimp applications.



PCTL-S1000

CTL Series Crimp Tools



Amphenol CTL Series crimp tools are sold complete as a tool handle with the die set included. Purchase of some or all of the seven tools shown below will allow the user to terminate most popular RG coaxial cables.

Cross Reference	
MIL--22520 Die Sets	227-No. Die Sets
/5-11, -13	-1221-11, -13
/5-09	-1221-09 & -32
/5 -57	-1221-25 & -57
-	-1414
/5-11, -13, -57 & -59	-1221-11, -13, -57 & -59 -980-1, -1409
/5-09, -13	-1221-09, -13, -980-1, -980-7
/5-13	-1221-13, -32, -980-1, -980-3

CTL Series Tool No.
CTL-1
CTL-2
CTL-3
CTL-4
CTL-5
CTL-6
CTL-8



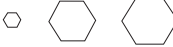

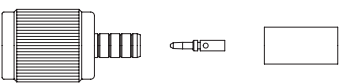









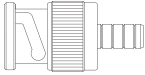

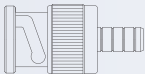

Tool Data

CTL Series Tool No.	Hex Sizes	Cable RG-/U	Connectors	Notes
CTL-1	 .068 (1.7) .213 (5.4) .255 (6.5)	RG-55, 58, 141, 142 223, 303, 400 RG-59, 62, 140, 210 Plenum 59, 62	 	for BNC, & TNC 3-Piece Crimp Connectors
PCTL-100 Die set only for Bench Crimper		Belden 9258, 9259, 9907, 89907		

▲ distributor stocked

CTL Series Tool No.	Hex Sizes	Cable RG-/U	Connectors	Notes
CTL-2 PCTL-200 Die set only for Bench Crimper	 .178 (4.5) .324 (8.2) .068 (1.7)	RG-6 RG-174, 188, 316 RG-179, 187 Plenum 58 Belden 8281		for BNC & TNC 3-Piece Crimp Connectors
CTL-3 PCTL-300 Die set only for Bench Crimper	 .100 (2.5) .429 (10.9) .213 (5.4)	RG-55, 58, 141, 142 223, 303, 400 RG-8, 11, 149, 213, 214, 225, 393 Ethernet Cables		for Type N 3-Piece Crimp Connectors
CTL-4 PCTL-400 Die set only for Bench Crimper	 .429 (10.9) .075 (1.9) .075 (1.9)	Belden 8227 9207, 89207 IBM 7362211 Twinax Cable		for Center Contacts of Twinax Plugs 82-5589 and 82-5589-RFX1
CTL-5 PCTL-500 Die set only for Bench Crimper	 .052 (1.3) .100 (2.5) .255 (6.5) .068 (1.7) .213 (5.4)	RG-55, 58, 141, 142 223, 303, 400 RG-59, 62, 140, 210 Plenum 59, 62 Belden 9258, 9259, 9907, 89907		for BNC, TNC, Mini-UHF, and Type N 3-Piece Crimp Connectors
CTL-6 PCTL-600 Die set only for Bench Crimper	 .178 (4.5) .255 (6.5) .068 (1.7) .052 (1.3)	RG-174 RG-59, 62 Plenum 59, 62		for 50Ω and 75Ω BNC & TNC 3-Piece Crimp Connectors
CTL-8 PCTL-800 Die set only for Bench Crimper	 .052 (1.3) .255 (6.5) .068 (1.7) .324 (8.2)	RG-59, 62 Plenum 59, 62 RG-6		for 50Ω and 75Ω BNC & TNC 3-Piece Crimp Connectors
CTL-9 PCTL-900 Die set only for Bench Crimper	 .128 (3.3) .068 (1.7) .178 (4.5)	RG-174, 188, 360, 180		for SMA Crimp Connectors
CTL-11 PCTL-1100 Die set only for Bench Crimper	 .116 (2.9) .429 (10.9)	Belden 9913, 9914, LMR 400		for Type N 3-Piece Crimp Connectors

Tool Data (continued)

CTL Series Tool No.	Hex Sizes				Cable RG-/U	Connectors	Notes
CTL-13 PCTL-1300 Die set only for BenchCrimper	 .105 (2.7)	 .128 (3.3)	 .151 (3.8)		RG-174178, 188, 196, 316, RD-36	  	MicroMate, SMB, SMA
CTL-14	 .255 (6.5)	 .319 (8.2)	 .324 (8.3)	 .042 (1.1)	Belden 8281, 1694A AT&T734A	  	for 3-Piece BNC Crimp Connectors
CTL-15	 .178 (4.6)	 .187 (4.8)	 .042 (1.1)		AT&T735A AT&T734A Belden 8218	  	for 3-Piece BNC Crimp Connectors

ECONOHEX™ Crimp Tool and Dies

The Amphenol ECONOHEX hand crimp tool is similar in features and application to the TRIHEX crimp tools. However, the ECONOHEX provides the additional feature of die set insertion and removal such that the purchase of the ECONOHEX tool handle and some or all of the four die sets will allow the user to terminate most popular RG coaxial cables as well as Twinaxial cable for IBM system 3X networks.



ECONOHEX order information

Amphenol Die Set Number	Cable RG-/U	Connector Series by Cavity Used	Hex Sizes Across Flats, In. (mm)	
			Cavity A (outer)	Cavity B (inner)
227-1420	8, 9, 11, 87A, 149, 165, 213, 214, 216, 225, 393	BNC, N	.429(10.9)	.100(2.5)
227-1419	55, 58, 141, 142, 142B, 223, 303, 400	BNC, RP-BNC, RP-TNC, RP-SMA	Cav. B = .213(5.4)	Cav. C = .068(1.7)
	59, 62, 140, 210, 302, Belden 9258, Amph. 621-6003	BNC	Cav. A = .255(6.5)	
227-1418	122, 180, 195, 316, Amphenol 21-597	BNC	.178(4.5)	.068(1.7)
227-1417	Belden 8227, 9207; IBM 7362211 Twinax Cable	B/C only center contacts of 82-5589 Twinax Plug	.429(10.9)	B/C = .075(1.9)
227-987	ECONOHEX Tool Handle without dies			

MMCX CTL Crimp Tool

Amphenol CTL Series crimp tools are sold complete as a tool handle with the die set included. Purchase of some or all of the tools shown below will allow the user to terminate most popular RG coaxial cables.

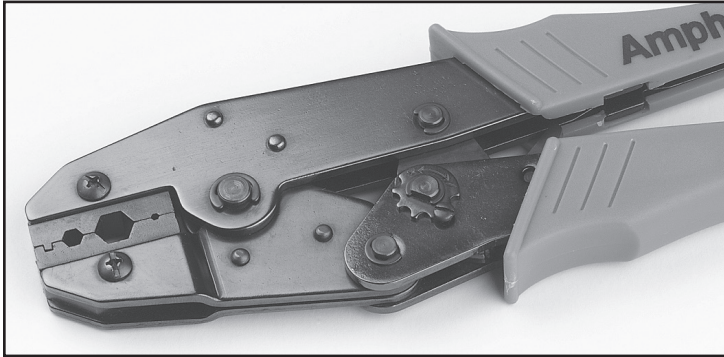

CAP Installation and Connector Removal Tool

Universal tool for MicroMate™ (MMCX) right angle connectors for protective cap mounting and decoupling of connectors.

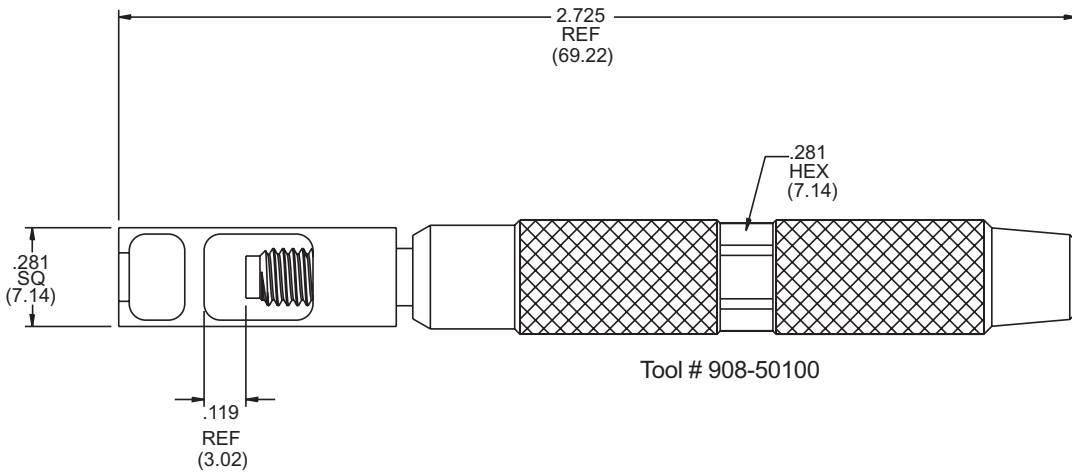

Hand Crimp Tool

The Amphenol TWINHEX crimp tool system is used in Industrial/Military Standard applications. It consists of a tool frame and a selection of die sets for use in assembling Amphenol RF connectors. The TWINHEX tool frame 227-944 (M22520/5-01) is sold without dies.



Die Sets for Crimp Tool 227-944

Amphenol Die Set Number	Military Die Set Number	Hex Size Inches (mm)	
		Cavity A (Outer)	Cavity B (Inner)
227-980-1	---	.255(6.5)	.049(1.2)
227-980-2	---	.178(4.5)	.049(1.2)
227-980-3	---	.324(8.2)	.052(1.3)
227-980-7	---	.178(4.5)	.052(1.3)
227-1221-3	M22520/5-03	.128(3.2)	.105(2.7)
227-1221-9	M22520/5-09	.178(4.5)	.068(1.7)
227-1221-11	M22520/5-11	.213(5.4)	.068(1.7)
227-1221-13	M22520/5-13	.255(6.5)	.068(1.7)
227-1221-15	M22520/5-15	.263(6.7)	.068(1.7)
227-1221-23	M22520/5-23	.384(9.8)	---
227-1221-25	M22520/5-25	.429(10.9)	.100(2.5)
227-1221-29	M22520/5-29	.324(8.2)	.100(2.5)
227-1221-32	M22520/5-32	.324(8.2)	.068(1.7)
227-1221-37	M22520/5-37	.314(8.0)	.151(3.8)
227-1221-57	M22520/5-57	.213(5.4)	.100(2.5)
227-1221-59	M22520/5-59	.255(6.5)	.100(2.5)
227-1221-61	M22520/5-61	.429(10.9)	.116(2.9)
227-1409	---	.213(5.4)	.052(1.3)sq.
227-1414	---	.429(10.9)	B/C= .075(1.9)
227-1448	---	.160(4.1)	.049(1.2)

TWINHEX Order Information

Amphenol Number	Military Number	Description
227-944	M22520/5-01	Hand Tool Frame for use with Twinhex 227-1221-XX and 227-980-X Die Sets (Die Sets sold separately)

Notes