

NTC THERMISTORS

WHAT IS A THERMISTOR

A thermistor is an electronic component that exhibits a large change in resistance with a change in its body temperature. The word “thermistor” is actually a contraction of the words “thermal resistor”.

The thermistors that we shall describe herein are ceramic semiconductors and have either large positive temperature coefficient of resistance (PTC devices) or large negative temperature coefficient of resistance (NTC devices). Both types of thermistors (PTC and NTC) have definite features and advantages which make them ideal for certain sensor applications.

NTC THERMISTORS

The NTC thermistors which are discussed herein are composed of metal oxides. The most commonly used oxides are those of manganese, nickel, cobalt, iron, copper and titanium. The fabrication of commercial NTC thermistors uses basic ceramics technology and continues today much as it has for decades. In the basic process, a mixture of two or more metal oxide powders are combined with suitable binders, are formed to a desired geometry, dried, and sintered at an elevated temperature. By varying the types of oxides used, their relative proportions, the sintering atmosphere, and the sintering temperature, a wide range of resistivities and temperature coefficient characteristics can be obtained.

Types of NTC Thermistors

Commercial NTC thermistors can be classified into two major groups depending upon the method by which electrodes are attached to the ceramic body. Each group may be further subdivided into various types of thermistors where each type is characterized by differences in geometry, packaging and/or processing techniques.

The first group consists of bead type thermistors. All of the bead type thermistors have platinum alloy leadwires which are directly sintered into the ceramic body. Bead type thermistors include the following:

- Bare Beads
- Glass Coated Beads
- Ruggedized Beads
- Miniature Glass Probes
- Glass Probes
- Glass Rods
- Bead-in-Glass Enclosures

The second group of thermistors have metallized surface contacts. All of these types are available with radial or axial leads as well as without leads for surface mounting or mounting by means of spring contacts.

Metallized surface contact thermistors include the following:

- Disks
- Chips (Wafers)
- Surface Mounts
- Flakes
- Rods
- Washers

NTC thermistors are available in a wide variety of configurations and protective coatings to suit almost any application. The most stable and accurate thermistors available are those which are hermetically sealed in glass. Hermetically sealed thermistors are also used, almost exclusively, for applications that require continuous exposure to temperatures above 150°C.

Fabrication of Bead Type Thermistors

Bead type thermistors are normally fabricated by applying a small dab of a slurry of mixed metal oxides with a suitable binder onto a pair of spaced platinum alloy leadwires. When the proper binder is used, surface tension draws the material into a bead that has the shape of an ellipsoid. The leadwires are strung in a fixture that applies a slight amount of tension to them and carefully controls the spacing between the wires. After the mixture has been allowed to dry, or has been partially sintered, the strand of beads is removed from the fixture and sintered. During the sintering, the thermistor oxides shrink about the platinum alloy wires to form intimate electrical and mechanical bonds.

BOWTHORPE THERMOMETRICS

Crown Industrial Estate, Priorswood Road
Taunton, Somerset TA2 8QY UK
Tel +44 (0) 1823 335200
Fax +44 (0) 1823 332637

THERMOMETRICS, INC.

808 US Highway 1
Edison, New Jersey 08817-4695 USA
Tel +1 (732) 287 2870
Fax +1 (732) 287 8847

KEYSTONE THERMOMETRICS CORPORATION

967 Windfall Road
St. Marys, Pennsylvania 15857-3397 USA
Tel +1 (814) 834 9140
Fax +1 (814) 781 7969

The beads are then individually cut from the strand in one of the desired lead configurations as shown in Figure <1>. The most common configurations are those that result in the adjacent and opposite cut leads. All commercial bead type thermistors have platinum alloy leads which range from .0007" to .004" (0.018 mm to 0.1 mm) diameter.

Although it is possible to obtain strain relief for the leads of a bare bead with organic coatings, it is more common to hermetically seal such units in glass. The use of an hermetic seal provides about a ten-fold improvement in the stability of a thermistor. Common glass structures are shown in Figure <2>.

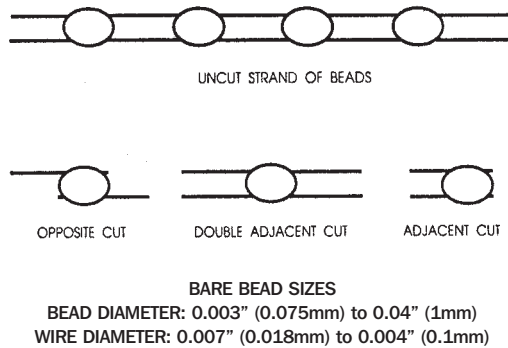

Figure 1: NTC Bead strands

<p style="text-align: center;">BARE BEADS .075 - 1.0 mm DIA</p>	<p style="text-align: center;">GLASS COATED BEADS .13 - 1.5 mm DIA</p>
<p style="text-align: center;">RUGGEDIZED GLASS BEADS .28 - 1.5 mm DIA.</p>	<p style="text-align: center;">MINIATURE GLASS PROBES .4 - 1.5 mm DIA.</p>
<p style="text-align: center;">LARGE GLASS PROBES 1.5 - 2.5 mm DIA.</p>	<p style="text-align: center;">LARGE GLASS RODS 1.5 - 2.5 mm DIA.</p>
<p style="text-align: center;">FAST RESPONSE PROBES 2 - 2.5 mm DIA.</p>	<p style="text-align: center;">BEAD IN GLASS BULB 4 - 10 mm DIA.</p>

Figure 2: NTC Bead types

In general, bead-type thermistors offer high stability and reliability, fast response times, and operation at high temperatures. They are available in small sizes and, consequently, exhibit comparatively low dissipation constants. They are more costly to manufacture than metallized surface contact type thermistors and interchangeability is normally achieved by using matched pairs of units connected in either series or parallel circuits.

- **Bare Beads:** The lead wire to ceramic contacts are not strain relieved in bare bead type thermistors and there is no protection against the environment. Consequently, bare beads should be used in applications where they are provided proper mounting and strain relief and where the environment is relatively inert.

- **Glass Coated Beads:** The thin glass coating on these thermistors can easily be ruptured during handling or assembly operations if proper care is not exercised. Stability is very good provided that the glass seal remains intact.

- **Ruggedized Beads:** The thick glass coating on these thermistors provides greater stability than their glass coated counterparts. They are recommended for applications where the customer will perform further assembly or handling.

- **Miniature Glass Probes:** The longer body length of the miniature glass rod makes these thermistors easier to handle and better suited for fluid immersion applications. The longer glass seal along the leads also provides for a more stable device.

- **Glass Probes:** These are bead type thermistors which have been sealed into the tip of a large diameter solid glass rod. Larger diameter leads of various glass sealing alloys are welded to the platinum alloy leadwires of the thermistor bead prior to the glass sealing operation. The glass probe type thermistors are generally the easiest to handle, the most durable and the most stable of the NTC devices.

- **Glass Rods:** These are axial lead versions of the glass probe type thermistor. The bead thermistor is sealed in the center of the solid glass rod. They offer the same ease of handling as the glass probe thermistors. The axial leads make them better suited for mounting on printed circuit boards.

- **Bead-in-Glass Enclosures:** These are bead type thermistors which are welded to larger diameter leads of various glass sealing alloys and then sealed into a large hollow glass enclosure (tube or bulb) that is usually evacuated or filled with an inert gas.

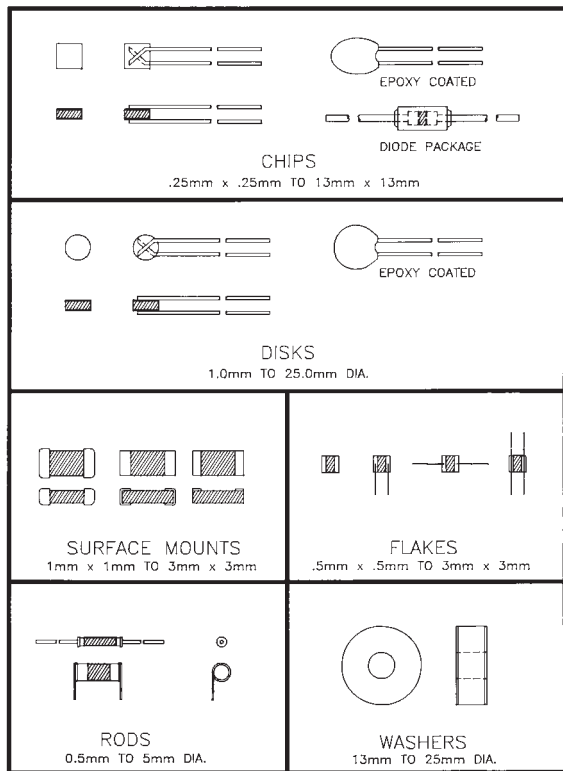

Figure 3: NTC Metallized surface contact type thermistor.

Fabrication of Surface Electrode Type Thermistors

The manufacturing methods used for thermistors that have metallized surface contacts are very similar to those used for ceramic capacitors. The most commonly used types are shown in Figure <3>.

The metallized surface contact type thermistors can be fabricated by any of several different methods depending upon the basic geometry of the device. Once the desired geometry has been obtained, the devices are sintered. The metallized surface contact is then applied by spraying, painting, screen printing, sputtering or dipping as required and the contact is fired onto the ceramic body. Some further adjustments may be made to the geometry of the device to provide for close tolerance on resistance or interchangeability.

Metallized surface contact type thermistors can be obtained with axial leads, radial leads or leadless. A variety of organic coatings are available for the metallized surface contact types. Very small chips are available with glass encapsulation and small disks and chips can also be obtained in a "diode package", so named because the glass body meets

the familiar outline dimensions of DO-35 glass sealed diodes.

Disk and chip thermistors are generally larger than the bead types and so they exhibit response times that are comparatively slower. However, they usually have higher dissipation constants than bead types and are thus better able to handle power in measurement, control or compensation applications. Disks and chips are characterized by low cost. They easily lend themselves to resistance adjustment by means of geometry modification, thus they are more readily available with interchangeable characteristics. Modern production processes have improved the overall stability and reliability of disk and chip thermistors, although most are not yet as good as some of the bead-type thermistors.

Although any of the metal electrodes used for thick-film circuit components may be used for the metallized surface contact types of thermistors, silver is most frequently used because of its comparatively low cost. When small chip gaps exist (i.e. flake and microcircuit chips), for which silver migration and solder leaching may present problems, gold, platinum or palladium alloys are often used. There are also some oxide systems for which other metals are more suitable for providing the ohmic contact.

- **Disks:** Disk type thermistors are made by compressing a blend of oxide powders in a round die using presses similar to those used for making powdered metal parts or pharmaceutical tablets. The "green" disks are then sintered at high temperatures.

Electrodes are applied to the flat surfaces using spraying or screen printing techniques. The diameter of a disk thermistor may be adjusted to a prescribed size using a centerless grinder. In this manner, the resistance of the disk may be adjusted to a nominal value. Diameters of disk thermistors range from 0.030" (0.75 mm) to 1.0" (25.4 mm). Disk type thermistors with diameters of less than 0.4" are typically used for low cost thermometry and temperature compensation applications, while those with diameters greater than 0.4" are used for inrush current limiting, surge suppression and time delay applications.

- **Chips:** NTC chip thermistors are usually fabricated using a "tape-casting" or "doctor-blading" process in which a slurry of material is spread out into a thick film sheet similar to the process used for making chip capacitors or ceramic substrates. The ceramic sheet material is then subjected to a controlled drying cycle. In the "green" state, the

sheet of material is reasonably flexible and easy to handle. The dried material is then cut into slabs or squares that are stacked on ceramic setters and sintered at high temperatures. Metallized electrodes are applied by using standard spraying, screening, or dipping techniques.

The typical commercial NTC chip thermistors are available with cross sectional areas that range from 0.010" x 0.010" (0.25 mm x 0.25 mm) up to 0.120" x 0.120" (3 mm x 3 mm) and with thicknesses that range between 0.006" (0.15 mm) and 0.030" (0.75 mm). Larger size and thicker chips are less economical to manufacture, however, they can be available upon special order. Chips are frequently used for precision thermometry applications because of their smaller sizes and faster response times when compared to disks. A typical low cost interchangeable NTC thermistor consists of a small chip that has been attached to leads, ground to a precision resistance tolerance at a controlled temperature, and then provided with an epoxy coating for protection.

Hybrid Mount type thermistors are leadless versions of chip type thermistors. They are intended for mounting directly to metallized pads on hybrid microcircuits, integrated circuits or printed circuit boards by either soldering or conductive epoxy bonding. A leadwire is then attached to the top electrode surface to complete the electrical connection.

- **Surface Mounts:** Surface mount type thermistors are leadless, rectangular devices which can either be formed in a die similar to disk type thermistors or they can be bladed and diced similar to chip type thermistors. Electrodes are applied such that they wrap around the edges of the device and the body dimensions are fixed with respect to printed circuit industry standards. Electrical connection to the circuit is accomplished either by means of reflow soldering or by conductive epoxy bonds.

- **Flakes:** Flake thermistors have been fabricated using the "doctor blade" or "tape-casting" methods as well as the standard screening techniques used in the manufacture of thick-film capacitors and resistors. After sintering, electrodes are applied to the flakes using any of the standard methods for film-type components. The low mass and high surface-to-mass ratio provided by flakes make these units ideally suited for passive infrared measurement.

- **Rods:** Rod-type thermistors are made by extruding a mixture of oxide powders and a suitable binder through a die. Their greater mass, longer thermal time constants and higher dissipation

constants makes them suitable for applications involving temperature compensation, time delay or surge suppression.

- **Washers:** Washer type thermistors are fabricated using techniques similar to those used for disks except that a hole is formed in the center during the pressing operation. Washers are usually connected to circuitry by means of spring clips or other hardware.

Comparison of NTC Thermistors to other temperature sensors

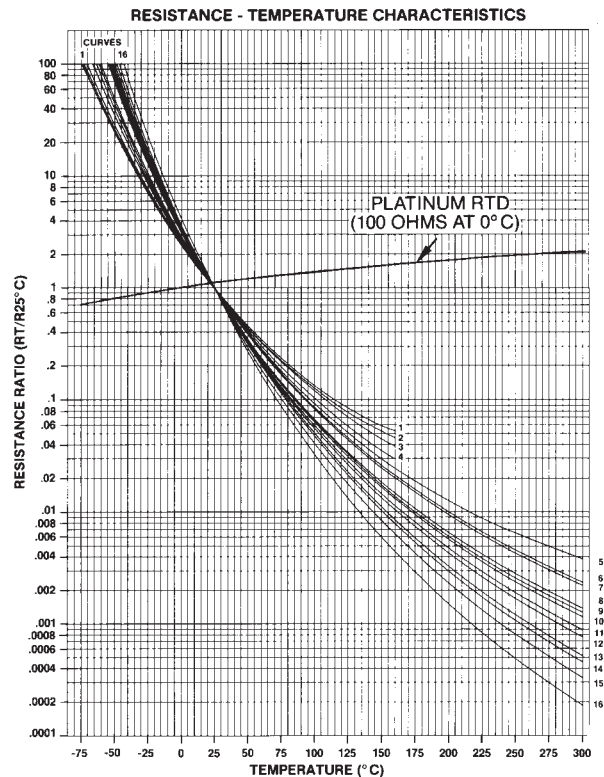

Figure 4: Resistance-ratio vs. temperature characteristics (NTC Thermistors vs. RTD's)

In Figure <4> the normalized resistance-temperature ratio characteristic is shown for several different NTC thermistors in comparison to that of a commercial resistance-temperature detector (RTD). A comparison of the curves will immediately show inherent advantages and disadvantages for both types of devices.

The ten-fold increase in sensitivity exhibited by NTC thermistor makes it advantageous to use such devices for low cost, precision temperature measurement and control. Another major advantage offered by thermistors is the availability of a wide range of relatively high resistance values. By using high resistance thermistors, the effects of

sensor lead resistance can be minimized. The non-linearity of the thermistor resistance-temperature characteristics puts a practical limit on the temperature span over which a single thermistor can be operated in a measurement or control circuit. RTD's have lower sensitivity, are more linear and can therefore be used in application where the temperature spans are very wide.

Thermistors have other important advantages over RTD's in that they are available in smaller sizes, with faster response times, at lower costs and with greater resistance to shock and vibration effects.

NTC thermistors compare very well to thermocouples over the limited temperature ranges where both sensors can be effectively used for temperature measurement and control. Of course, thermocouples will operate at much higher temperatures and over much wider spans and are available in very fine wire diameters. However, thermocouples have some notable disadvantages. First the thermal EMF values produced by thermocouples (thermoelements) are on the order of a few microvolts per degree. Second, the electronic circuits used for thermocouple measurement and control applications must provide high gain, low noise amplification of the signal and provide compensation for the cold junction temperature. Third, the stability and accuracy of base metal thermocouples can be degraded by environmental factors and non-homogeneities. As such, NTC thermistors provide greater sensitivity, stability and accuracy than thermocouples and can be used with less complex, less costly instrumentation.

NTC thermistors also have advantages over the solid state sensors that are finding widespread use in direct digital temperature measurement and control applications. The solid state devices produce an output signal that is proportional to temperature over operationing ranges that fall within the overall range of -55° to +150°C. The solid state devices can be incorporated into application specific integrated circuits for direct readout of temperatures. They exhibit accuracy and linearity specifications in the range of ±0.3°C (selected) up to ±4°C over their published ranges. Packaging of the devices can take any of the standard outline dimensions for solid state devices.

The NTC thermistors, by comparison, offer better sensitivity and accuracy over the operating temperature ranges, smaller sizes with faster response times and can be obtained in a wider assortment of device packages or sensor housings. Glass encapsulated NTC thermistors will also perform in much higher operating and storage temperatures than the solid state devices.

PROPERTIES OF NTC THERMISTORS

NTC thermistors have thermal and electrical properties which are important considerations in each application. These properties are a function of the geometry of the thermistor, of the particular "material system" of metal oxides that is being used and of the additional materials (electrodes, inks, solders, leadwires, etc.) that are applied to the basic device.

These properties and other product data are presented in the manufacturers catalogs as nominal resistance values, resistance-vs-temperature curves (tables), thermal time constant values, dissipation constant values and power ratings.

Thermal Properties

When an NTC thermistor is connected in an electrical circuit, power is dissipated as heat and the body temperature of the thermistor will rise above the ambient temperature of its environment. The rate at which energy is supplied must equal the rate at which energy is lost plus the rate at which energy is absorbed (the energy storage capacity of the device).

$$\frac{dH}{dt} = \frac{dH_L}{dt} + \frac{dH_A}{dt} \quad (1)$$

The rate at which thermal energy is supplied to the thermistor in an electrical circuit is equal to the power dissipated in the thermistor.

$$\frac{dH}{dt} = P = I^2R = EI \quad (2)$$

The rate at which thermal energy is lost from the thermistor to its surroundings is proportional to the temperature rise of the thermistor.

$$\frac{dH_L}{dt} = \delta \Delta T = \delta (T - T_A) \quad (3)$$

where: the dissipation constant (δ), is defined as the ratio, at a specified ambient temperature, of a change in the power dissipation of a thermistor to the resultant body temperature change. The dissipation constant depends upon the thermal conductivity and relative motion of the medium in which the thermistor is located, as well as the heat transfer from the thermistor to its surroundings by conduction through the leads, by free convection in the medium and by radiation. The dissipation

BOWTHORPE THERMOMETRICS

Crown Industrial Estate, Priorswood Road
Taunton, Somerset TA2 8QY UK
Tel +44 (0) 1823 335200
Fax +44 (0) 1823 332637

THERMOMETRICS, INC.

808 US Highway 1
Edison, New Jersey 08817-4695 USA
Tel +1 (732) 287 2870
Fax +1 (732) 287 8847

KEYSTONE THERMOMETRICS CORPORATION

967 Windfall Road
St. Marys, Pennsylvania 15857-3397 USA
Tel +1 (814) 834 9140
Fax +1 (814) 781 7969

constant is not a true constant since it varies slightly with temperature and also with temperature rise. It is typically measured under equilibrium conditions.

The rate at which thermal energy is absorbed by the thermistor to produce a specific amount of rise in temperature can be expressed as follows:

$$\frac{dH_A}{dt} = sm \frac{dT}{dt} = C \frac{dT}{dt} \quad (4)$$

where: (s) is the specific heat and (m) is the mass of the thermistor. The product of the specific heat and the mass is the heat capacity (C) of the thermistor and is dependent upon thermistor materials and construction. Thus, the heat transfer equation for an NTC thermistor at any instant in time after power has been applied to the circuit can be expressed as:

$$\frac{dH}{dt} = P = I^2R = EI = \delta(T-T_A) + C \frac{dT}{dt} \quad (5)$$

In order to complete our analysis of the thermal characteristics of thermistors, we must examine the thermistor behavior under transient and steady state conditions. The solution of equation (5) where the power (P) is constant is:

$$\Delta T = (T-T_A) = \frac{P}{\delta} \left[1 - \exp \left\{ \frac{-\delta}{C} t \right\} \right] \quad (6)$$

Equation (6) demonstrates that when a significant amount of power is dissipated in a thermistor, its body temperature will rise above the ambient temperature as a function of time. The transient conditions at “turn on”, and all applications that are based upon the Current-Time Characteristics, are governed by equation (6).

A condition of equilibrium is achieved when $dT/dt=0$ in equation (5) or when $t \gg C/\delta$ in equation (6). In this steady state condition, the rate of heat loss is equal to the power supplied to the thermistor.

Therefore:

$$\delta(T-T_A) = \delta\Delta T = P = E_T I_T \quad (7)$$

where: (E_T) is the steady state or static thermistor voltage and (I_T) is the steady state current. The Voltage-Current Characteristic is governed by this equation. When the power is reduced in a thermistor to an amount where the self-heating is considered negligible, then the heat transfer equation can be re-written as follows:

$$\frac{dT}{dt} = \frac{-\delta}{C} (T-T_A) \quad (8)$$

Equation (8) is actually a mathematical statement of Newton's Law of Cooling and has the following solution:

$$T = T_A + (T_I - T_A) \exp \left\{ \frac{-t}{\tau} \right\} \quad (9)$$

where: (T_I) is the initial body temperature, (T_A) is the ambient temperature and (τ) is the thermal time constant of the device. Also, $\tau = C/\delta$.

The thermal time constant (τ) is the amount of time required for a thermistor to reach 63.2% of the temperature difference when subjected to a step function change in temperature under negligible power dissipation conditions. The thermal time constant is dependent upon the same environmental factors as the dissipation constant, namely, the thermal conductivity and the motion of the medium, the conduction through the leads, the free convection in the medium and the radiation losses. The thermal time constant and dissipation constant data which is given in thermistor product literature must indicate the test methods and mounting methods employed if it is to be valuable to the designer. Devices with leads are normally suspended by their leads in a still medium for testing purposes.

Thus far, all of the discussions of thermal properties of NTC thermistors have been based upon a simple device structure with a single time constant. When any thermistor device is encapsulated into a sensor housing, the simple exponential response functions no longer exist. The mass of the housing and the thermal conductivity of the materials used in the sensor will normally increase the dissipation constant of the thermistor and will invariably increase the thermal response time. The thermal properties are somewhat difficult to predict by mathematical modeling and manufacturing variances will introduce enough uncertainty so that testing of the finished sensor is usually required to obtain data on the response time and dissipation constant.

Electrical Properties

There are three basic electrical characteristics that account for virtually all of the applications in which NTC thermistors may be used.

- Current-Time Characteristic
- Voltage-Current Characteristic
- Resistance-Temperature Characteristic

There are also several applications where the NTC thermistor is indirectly heated by resistive devices or even other thermistors. These applications are merely special cases of one of the three basic electrical characteristics.

Current-Time Characteristic

In our analysis of the thermal properties of NTC thermistors, we observed that a self heated thermistor exhibits a body temperature rise that is a function of time. This is mathematically expressed in equation (6).

A transient condition exists in a thermistor circuit from the time at which power is first applied from a Thevenin source, ($t=0$), until the time at which an equilibrium condition is achieved, ($t > \tau$). Generally, the excitation is considered to be a step function in voltage through a Thevenin equivalent source. During this time the current will rise from an initial value to a final value and this current change as a function of time is called the "Current-Time Characteristic".

The Current-Time Characteristic is not a simple exponential relationship. The rate of current change will be initially low due to the high resistance of the thermistor and the added source resistance. As the device begins to self-heat, the resistance will decrease rapidly and the rate of current change will increase. Finally, as the device approaches an equilibrium condition, the rate of current change will decrease as the current reaches its final value.

The factors which affect the Current-Time Characteristic are the heat capacity of the device (C), the dissipation constant of the device (δ), the source voltage, the source resistance and the resistance of the device at a specified ambient temperature. The initial and final current values and the time required to reach the final current value can be altered as needed by proper circuit design.

The Current-Time Characteristic is used in time delay, surge suppression, filament protection, overload protection and sequential switching applications.

Voltage-Current Characteristic

Once a self-heated thermistor has reached a condition of equilibrium, the rate of heat loss from the device will be equal to the power supplied. It is mathematically expressed by equation (7).

If the dissipation constant variations are negligible for a specified medium and set of conditions, and the resistance-temperature characteristic is known, then equation (7) can be solved for the static voltage-current characteristic. This characteristic can be plotted on log-log coordinates where lines of constant resistance have a slope of +1 and lines of constant power have a slope of -1 such as shown in Figure <5>. For some applications it is more convenient to plot the static voltage-current characteristic on linear coordinates such as shown in Figure <6>.

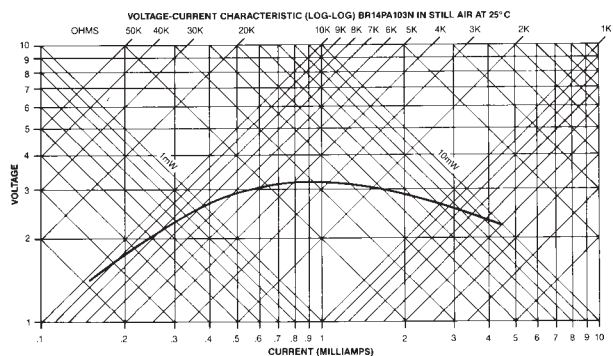

Figure 5: Typical Voltage-Current Characteristic (log-log scale)

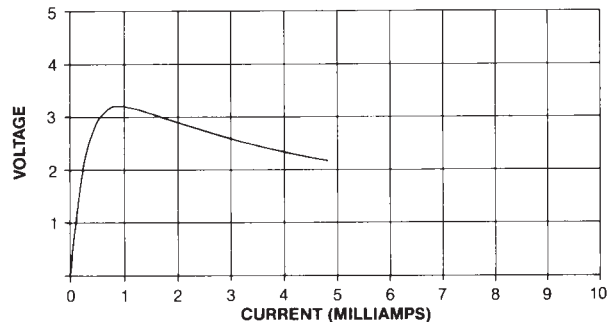

Figure 6: Typical Voltage-Current Characteristic (linear scale)

When the amount of power dissipated in the thermistor is negligible, the voltage-current characteristic will be tangential to a line of constant resistance that is equal to the zero-power resistance of the device at the specified ambient temperature.

Resistance-Temperature Characteristic

As the current continues to be increased, the effects of self-heating become more evident and the temperature of the thermistor rises with a resultant decrease in its resistance. For each subsequent incremental increase in current there is a corresponding decrease in resistance. Hence, the slope of the voltage-current characteristic ($\Delta E/\Delta I$) decreases with increasing current. This continues until a current value (I_p) is reached for which the slope becomes zero and the voltage reaches a maximum value (E_p). As the current is increased above the value of (I_p), the slope of the characteristic continues to decrease and the thermistor exhibits a negative resistance characteristic.

A maximum power rating as well as power derating curve is usually given for each thermistor type. Care should be exercised when designing a circuit for a self heated application so that the thermistor is operated within the maximum power limitations.

There are many applications which are based upon the static voltage-current characteristic. These applications can be grouped according to the type of excitation which is employed to vary the voltage-current characteristic.

The first major group involves applications where the dissipation constant is varied. This can be accomplished by changing the thermal conductivity of the medium, the relative motion of the medium or the heat transfer from the thermistor to its surroundings. Typical applications would include vacuum manometers, anemometers, flow meters, liquid level, fluid velocity, thermal conductivity cells, gas chromatography and gas analysis.

The second major group involves applications where the electrical parameters of the circuit are varied. This would involve a change in the Thevenin source voltage or source resistance. Typical applications would include automatic gain or amplitude control, voltage regulation, equalization, volume limiters, signal compression or expansion and switching devices.

The third and fourth major groups involve applications where the ambient temperature is varied. In one case the change is thermal, while in the other case the change is due to radiation absorbed by the thermistor. Temperature control and alarm indication are examples of applications where the change is thermal. Microwave power measurement is an example of an application where the change is due to absorbed radiation.

There are many applications based upon the resistance-temperature characteristic and they can be grouped into the general categories of resistance thermometry, temperature control or temperature compensation. In the previous discussions of the current-time and voltage-current characteristics, we examined devices that were operated in a self-heated mode (heated above the ambient temperature by the power being dissipated in the thermistor). For most applications based on the R-T characteristic the self-heating effect is undesirable and one attempts to work with as close to zero-power as possible.

The zero-power resistance of a thermistor (R_T) at a specified temperature (T) is the DC resistance measured when the power dissipation is negligible. By definition in MIL-PRF-23648, the power is considered to be negligible when "any further decrease in power will result in not more than 0.1 percent (or 1/10 of the specified measurement tolerance, whichever is smaller) change in resistance".

There are two models presently used to explain the electrical conduction mechanism for NTC thermistors. One explanation involves the so called "hopping" model and the other explanation is based upon the "energy band" model. Both conduction models have difficulty when it comes to a complete explanation of the R-T characteristics of metal oxide thermistors. Fortunately, there are a number of equations that can be used to define the resistance-temperature characteristic of the devices.

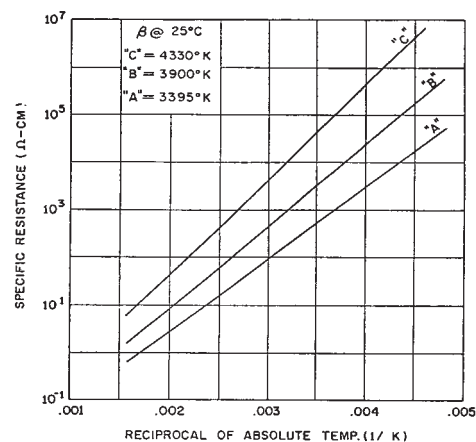

Figure 7: R-T Characteristics

The R-T characteristic of semiconductors is very often plotted with the logarithm of specific resistance expressed as a function of the reciprocal of absolute temperature. In Figure <7>, the R-T characteristics of three commonly used thermistor materials are shown in terms of their specified resistances and inverse absolute temperatures. The resistance-ratio versus temperature characteristics for these materials are specified in MIL-PRF-23648.

It can be demonstrated that, over any specified temperature range for which the slope of a given material system curve may be considered to be constant (straight line relationship between $\ln R_T$ and $1/T$), the resistance of the device at any temperature within the specified range may be expressed as:

$$R_T = R_{T0} \exp \left[\frac{\beta (T_0 - T)}{T T_0} \right] \quad (10)$$

where: (R_T) is the resistance at an absolute temperature (T) expressed in kelvins ($^{\circ}\text{C} + 273.15$); (β) is the "beta" or "material constant" is the slope of the thermistor R-T characteristic (in kelvins) over the specified temperature range; and, R_{T0} is the resistance at a specified reference temperature, T_0 , that is also expressed in kelvins.

Equations (10) appears most frequently in NTC thermistor literature. Thermistor manufacturers will provide "beta" information for each of the material systems they offer. Temperature spans of 0 to 50 $^{\circ}\text{C}$, 25 to 85 $^{\circ}\text{C}$, 25 to 125 $^{\circ}\text{C}$ and 100 to 200 $^{\circ}\text{F}$ are most common, however, any two data points can be used for solution. The terms equation (10) can be rearranged to solve for beta or temperature:

$$\beta = \frac{T T_0}{T_0 - T} \ln \left[\frac{R_T}{R_{T0}} \right] \quad (11)$$

$$t(^{\circ}\text{C}) = \left[\frac{1}{\beta} \ln \left[\frac{R_T}{R_{T0}} \right] + \frac{1}{T_0} \right]^{-1} - 273.15 \quad (12)$$

Also, the temperature coefficient of resistance or "alpha" (α) of an NTC thermistor is defined as:

$$\alpha = \left[\frac{1}{R_T} \right] \frac{d R_T}{dT} \quad (13)$$

By solving equation (10) for "alpha" (α) we obtain:

$$\alpha = - \frac{\beta}{T^2} \quad (14)$$

Equations (10) through (14) cited above are valid only over small temperature spans for which the slope of the $\ln R_T$ vs $1/T$ characteristic approximates a straight line. At temperatures above 0 $^{\circ}\text{C}$, the uncertainties associated with the use of these equations are approximately as follows:

Temp. span ($^{\circ}\text{C}$)	10	20	30	40	50
Uncertainty ($^{\circ}\text{C}$)	0.01	0.04	0.10	0.20	0.30

The more recent literature on thermistors accounts for the non-linearity of $\ln R_T$ vs $1/T$ characteristic by using the standard curve fitting technique of considering $\ln R_T$ to be a polynomial in $1/T$ or vice versa.

Excellent results have been obtained with the use of the following third order polynomials:

$$\frac{1}{T} = a + b[\ln R_T] + c[\ln R_T]^2 + d[\ln R_T]^3 \quad (15)$$

$$\ln R_T = A_0 + \frac{B}{T} + \frac{C}{T^2} + \frac{D}{T^3} \quad (16)$$

$$\frac{1}{T} = b_0 + b_1[\ln R_T]^2 + b_3[\ln R_T]^3 \quad (17)$$

$$\ln R_T = B_0 + \frac{B_1}{T} + \frac{B_3}{T^3} \quad (18)$$

The use of equation (15) was originally proposed by Steinhart and Hart for the oceanographic range of -2 to +30 $^{\circ}\text{C}$. They also indicated that there was no significant loss in accuracy when the squared term, $a_2 \{ \ln R_T \}^2$, was eliminated as in equation (17).

The work of Steinhart and Hart was confirmed by studies conducted by B.W. Mangum at NBS and R. Koehler at Woods Hole Oceanographic Institute. However, they found that greater accuracy is obtained when the squared term is retained.

The results of the investigations conducted at Thermometrics, Inc. indicate excellent curve fit using third degree polynomials and are summarized in the Table <1>.

Because equations (15) and (16) each have four unknown constants, a minimum of four calibration data points are required in order to determine the constants. The constants may be obtained from the solution of four simultaneous equations if only four data points are given, or, they may be obtained by polynomial regression analysis when more than four points are given. Such an analysis statistically improves the accuracy of the data.

Table 1: Summary of curve fitting errors

- | | |
|-----|---|
| A) | Full third degree polynomials, such as equations (15) and (16), do not introduce interpolation errors that exceed the total measurement uncertainty (typically 0.005°C to 0.010°C) for: |
| a1) | 100°C spans within the overall range of -80 to +260°C. |
| a2) | 150°C spans within the overall range of -60 to +260°C. |
| a3) | 150 to 200°C spans within the overall range of 0 to +260°C except that the interpolation error begins to approximate the measurement uncertainties. |
| B) | Third degree polynomials with the squared term eliminated, such as equations (17) and (18), introduce interpolation errors that do not exceed the following conditions: |
| b1) | .001 to .003°C error for 50 °C spans within the overall range of 0°C to +260°C. |
| b2) | .010 to .020°C error for 50°C spans within the overall range of -80 to 0°C. |
| b3) | .010°C error for 100°C spans within the overall range of 0 to +260°C. |
| b4) | .020 to .030°C error for 100°C spans within the overall range of -80 to +25°C. |
| b5) | .015°C error for 150°C span (+50 to +200°C). |
| b6) | .045°C error for 150°C span (0 to +150°C). |

- b7) .100°C error for 150°C span (-60 to +90°C).
b8) .080°C error for 200°C span (0 to +200°C).

If we define the material constant (β) as the slope of the $\ln R_T$ vs $1/T$ characteristic, then from equation (16) we can derive the following:

$$\beta = B + \frac{2C}{T} + \frac{3D}{T^3} \quad (19)$$

The temperature coefficient of resistance (α) defined by equation (14) may also be obtained from equation (16) as:

$$\alpha = - \left[\frac{B}{T^2} + \frac{2C}{T^3} + \frac{3D}{T^4} \right] \quad (20)$$

Equations (17) and (18) both make use of three constants. Consequently, they require only three calibration data points and the solution of three simultaneous equations to determine the values of the unknown constants. When using these equations, the material constant (β) and the temperature coefficient of resistance (α) may be expressed as follows:

$$\beta = B_1 + \frac{3B_3}{T^3} \quad (21)$$

$$\alpha = - \left[\frac{B_1}{T^2} + \frac{3B_3}{T^4} \right] \quad (22)$$

Although characteristic curves of $\ln R_T$ vs $1/T$ are useful for deriving interpolation equations, it is more common for manufacturers to provide nominal thermistor resistance values at a standard reference temperature (usually specified as 25°C) as well as resistance-ratio vs temperature characteristics.

SPECIFYING NTC THERMISTORS

To the design engineer attempting to specify, or, to the purchasing agent attempting to procure, the task of choosing the correct NTC thermistor may sometimes seem to be an impossible task. While the process can be difficult at times because of subtleties in the use of each product type, it is not nearly impossible if one has a good understanding of the basics.

Product Type and Size:

Usually, the designer or user will have a good idea as to the device size, thermal response time or other physical characteristic that they desire in the thermistor. Even if there is only limited information available, it is usually enough to "rule out" whole families of NTC product types because they will be too far from the desired characteristics. A careful consideration of what the thermistor is intended to do in the application will also provide clues as to which products are inappropriate.

Resistance-Temperature Curves:

Most NTC thermistor manufacturers provide tables of either resistance or resistance-ratio versus temperature for each of the material systems that they offer in their respective product lines. Often the manufacturer will also provide the coefficients for the various thermistor equations in order to assist the designer or user to interpolate the R-T data. There are a great many material systems in use and each one has certain limitations with respect to the type of thermistor that can be manufactured, the size of the thermistor, temperature ranges for operation and storage, as well as the range of available nominal resistance values.

Nominal Resistance Value:

The next common starting point when specifying a thermistor is to choose the nominal resistance at a specified temperature. As previously mentioned, manufacturers will present a range of available resistance values for each NTC product type and its associated material systems. The usual reference temperature is 25°C, however, many other reference temperatures can be specified. If the desired resistance value is not available for that combination of product type and material system, then the user must determine which is more important: the product type and size, or, the material system with its defined resistance-ratio versus temperature data. The user can not specify all three parameters (nominal resistance, product type/size, material system) if the combination falls outside of the manufacturers guidelines.

Resistance Tolerance:

The standard tolerances available for each thermistor type are given on the specific product data sheet. Typically, the bead type thermistors will have a distribution (3 sigma) of the zero-power resistance at the reference temperature of about $\pm 20\%$ to $\pm 25\%$ depending upon sizes. The metallized surface contact type thermistors have typical resistance distributions of about $\pm 5\%$ to $\pm 10\%$, except for flake type thermistors where distribution may be $\pm 20\%$ or greater. Specifying the broadest possible tolerance for the application will provide the most cost effective solution. Of course, tighter zero-power resistance tolerances are available for all types of thermistors, however, the lower expected yield from the production lots will translate into higher cost. In this regard, the metallized surface contact type thermistors have an advantage since their shapes can easily be adjusted or trimmed to provide closer tolerances at lower costs.

Beta Tolerance:

The beta of a thermistor is determined by the composition and structure of the various metal oxides being used in the device. The beta can also be influenced by some manufacturing process variables. The result will be a variation from unit to unit within a production lot as well as from lot to lot.

For bead type thermistors, beta tolerances are usually on the order of $\pm 1\%$ to $\pm 3\%$ (up to $\pm 5\%$ is possible for some material systems). For the metallized surface contact type thermistors, beta tolerances will range from $\pm 0.5\%$ up to $\pm 3\%$.

Resistance Limits:

The maximum and minimum resistance values at the reference temperature are fixed by the specified tolerance. As the temperature is changed from the reference temperature, however, the maximum and minimum limits (as percentage of the nominal resistance) will increase due to the effects of the tolerance on the material constant, beta (β).

If the temperature span is small enough so that the beta can be considered constant, then equation (10) can be used to solve for the minimum and maximum resistance values. The equation is solved for all the possible combinations of high and low resistance as well as high and low beta. A typical plot of the resulting R-T data is shown in figure <8>.

EFFECT OF BETA TOLERANCE ON RESISTANCE LIMITS

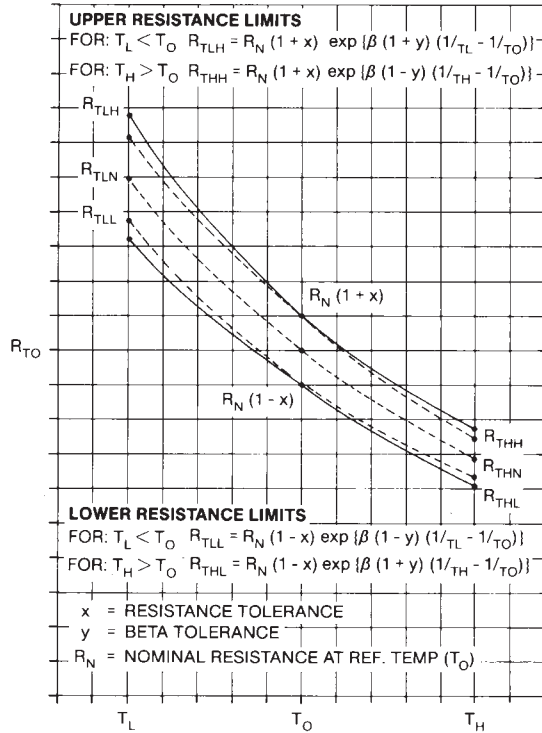

Figure 8: Effect of beta tolerance on Resistance Limits.

The effect of beta tolerance on the resistance limits must be considered in any thermistor application. Therefore, in many high or low temperature applications it is desirable to specify the nominal resistance at the operating temperature or at a convenient mid point in the operating temperature range. In the example for Figure <8> we are given:

$R_{NOMINAL} = R_{T0} @ T_0 = 10000 \text{ Ohms @ } 25^\circ\text{C}$

Beta (0/50) = 3450 kelvins

x = resistance tolerance = $\pm 10\% = \pm 0.1$

y = beta tolerance = $\pm 5\% = \pm 0.05$

$T_L = 15^\circ\text{C}$ and $T_H = 35^\circ\text{C}$

$R_{TLH} = 16769.3 \text{ Ohms}$ $R_{THH} = 7699.5 \text{ Ohms}$

$R_{TLN} = 14941.7 \text{ Ohms}$ $R_{THN} = 6869.4 \text{ Ohms}$

$R_{TLL} = 13180.3 \text{ Ohms}$ $R_{THL} = 6067.5 \text{ Ohms}$

Note that in this example the zero-power resistance tolerance at 15°C is $+12.23\%$, -11.79% ; while it is $+12.08\%$, -11.67% at 35°C . This compares to the nominal tolerance of $\pm 10\%$ at 25°C .

Curve Matching and Interchangeability:

For some applications the operating temperature range is too wide to permit the proper use of equation (10). In such cases, or in cases where it is desirable to have a uniform tolerance over the range, the resistance limits are specified for the minimum and the maximum operating temperatures. This two point constraint (actually a limitation on the beta) requires that devices be selected to closely track a given resistance-temperature or ratio-temperature characteristic. After the thermistors are manufactured they would be limit tested at the minimum and maximum operating temperatures. The cost of such "curve matching" will obviously depend upon the resistance tolerance and ratio tolerance desired as well as the operating range.

Thermistors which have very close resistance tolerances and which can be readily substituted without the need for circuit adjustments and recalibration are called "Interchangeables". Very often these devices have curve tolerances which are expressed as a temperature uncertainty over the operating temperature range rather than as a resistance uncertainty. When the curve tolerance is so expressed, the resistance limits at the low temperature point will be slightly greater than the resistance limits at the high temperature point. This is due to the greater values for the temperature coefficient of resistance (alpha) at lower temperatures. It follows then, that when curve tolerances are given as a resistance uncertainty, the temperature uncertainty will be lesser at the low temperature point and greater at the high temperature point.

Metallized surface contact type thermistors have generally better control on the beta variations and can be readily adjusted by grinding away material to obtain a specified resistance with close tolerances. As such, these devices are most commonly used for applications requiring interchangeability, reasonable stability, low to moderate cost and where operational temperatures do not exceed 105°C .

For applications that involve operational or storage temperatures in excess of 105°C , thermistors that have been hermetically sealed into glass and can withstand exposure to temperatures up to 250°C , however, their interchangeable range is generally limited to 105°C . When applications require interchangeability as well as operational and storage temperatures of up to 300°C , then matched pairs of hermetically sealed bead type thermistors are recommended.

The beta and resistance tolerances for bead type thermistors are generally too broad to permit effective and economic use of a single thermistor in such high temperature, interchangeable applications — unless the temperature span is very small. The usual approach to a solution involves the calibration of the bead type thermistors at two or more temperature points over the operating range. The data is entered into computer files for sorting and analysis. The beads are then matched such that high and low beta values offset each other. Thus, when the beads are connected in either a series or parallel pair, they will behave as a single interchangeable device and track a defined resistance-temperature characteristic.

Such matching of bead type thermistors, (beads, probes or rods) is more costly than precision grinding of metallized surface contact type thermistors. However, it may be the only acceptable solution for applications where small sizes, continuous operation at high temperatures or high reliability are required.

Practical limits for interchangeability are determined by the ability to control the tolerances on resistance and beta over the desired temperature range. Some practical limits for interchangeable thermistors that are both cost effective and commercially available are listed in Table <2>.

Table 2: Practical limits for interchangeability.

All NTC thermistor types with an overall operational range of -80°C to 105°C:

- ±0.05°C for spans of up to 50°C
- ±0.10°C for spans of up to 75°C
- ±0.20°C for spans of up to 100°C

ALL glass sealed NTC thermistor types with an overall operations range of -80°C to +300°C

- ±0.50°C over spans of up to 200°C

Calibration

Some applications have accuracy requirements which are tighter than the conventional limits on interchangeable devices. For these applications the thermistors must be calibrated. To use one of the interpolation equations over a specified range, the thermistor must be calibrated at two or more temperatures. [Reference equations (10), (15), (16), (17) and (18)].

The accuracy of the computer R-T characteristic over the temperature range depends upon the proper selection of equation and reference temperatures as well as upon the calibration uncertainties. The resistance tolerance, beta tolerance or interchangeability of the thermistor will have no influence upon the accuracy of the calibrations. Thus, low cost, broad tolerance thermistors (with suitable stability) can be purchased with precision calibrations.

The calibration schedules available for thermistors or assemblies manufactured by Thermometrics are listed in Table IV.

Obviously, not all thermistors or assemblies can be calibrated at all temperatures over the range. There will be limitations which are imposed by the type of thermistor and its nominal resistance as well as by the materials used in the construction of the assembly. The basic calibration schedules and the types of thermistor to which they apply are described as follows. When a current source and digital voltmeter are used for calibration, suitable averaging and integration techniques are used to eliminate noise spikes. Thermal EMF's are eliminated by either subtracting the zero current readings or averaging forward and reverse polarity readings.

Calibration Schedule	Resistance Accuracy	Temperature Accuracy (±°C) for ranges shown				
		-140°C -80°C	-80°C 0°C	0°C +60°C	+60°C +125°C	+125°C +260°C
1	0.005%	-	-	0.001°C	-	-
1A	0.005%	-	0.003°C	0.003°C	0.003°C	-
1B	0.005%	0.005°C	0.005°C	0.005°C	0.005°C	0.005°C
2	0.01%	0.005°C	0.005°C	0.005°C	0.005°C	0.005°C
3	0.01%	0.010°C	0.010°C	0.010°C	0.010°C	0.010°C
3M	0.05%	0.010°C	0.010°C	0.010°C	0.010°C	0.010°C
4	0.05%	0.050°C	0.050°C	0.050°C	0.050°C	0.050°C
5	0.1%	0.050°C	0.050°C	0.050°C	0.050°C	0.050°C

BOWTHORPE THERMOMETRICS
 Crown Industrial Estate, Priorswood Road
 Taunton, Somerset TA2 8QY UK
 Tel +44 (0) 1823 335200
 Fax +44 (0) 1823 332637

THERMOMETRICS, INC.
 808 US Highway 1
 Edison, New Jersey 08817-4695 USA
 Tel +1 (732) 287 2870
 Fax +1 (732) 287 8847

KEYSTONE THERMOMETRICS CORPORATION
 967 Windfall Road
 St. Marys, Pennsylvania 15857-3397 USA
 Tel +1 (814) 834 9140
 Fax +1 (814) 781 7969

SCHEDULE 1:

Available only for thermistor standards, ultra-stable thermistor probes or assemblies which incorporate these devices. Calibrations are made in an integrating block submerged in a precision constant temperature bath. The bath and block temperature is established using an SPRT, resistor standards and a four wire comparison bridge. Resistance measurements of the thermistors are made using a precision Wheatstone bridge or a stable, precision current source and digital voltmeter in conjunction with a data acquisition system verified against standard resistors and an ohmic standard precision resistance decade.

SCHEDULE 1A and 1B:

Available only for thermistor standards, ultra-stable thermistor probes or assemblies which incorporate these devices. The bath and block temperature is established using two or more thermistor temperature standards which have been calibrated against an SPRT. Resistance measurements are performed the same as for Schedule 1.

SCHEDULE 2:

Available for all glass probe thermistors or assemblies which incorporate these devices. Stability requirements with respect to temperature range and time span must be verified prior to calibration. The bath and block temperature is established using two or more thermistor temperature standards which have been calibrated against an SPRT. Resistance measurements are performed using a precision Wheatstone bridge or a stable, precision current source and digital voltmeter in conjunction with a data acquisition system verified against standard resistors and an ohmic standard precision resistance decade.

SCHEDULE 3:

Available for all glass enclosed beads and probes as well as epoxy encapsulated discs or chips and sensor assemblies using these devices. It is advised that stability required be verified prior to calibration. A precision constant temperature bath is set using two or more thermistor temperature standards. Resistance measurements are performed using a precision Wheatstone bridge or a stable precision current source and digital voltmeter in conjunction with a data acquisition system verified against standard resistors and an ohmic standard precision resistance decade.

SCHEDULE 3M or 4:

Available for all thermistors and sensor assemblies. A constant temperature bath is set using two or more thermistor standards. Resistance measurements are performed using a calibrated Wheatstone bridge, digital meter or data acquisition system.

SCHEDULE 5:

Available for all thermistors and sensor assemblies. A constant temperature bath is set using two or more thermistor standards. Resistance measurements are performed using a digital meter.

In addition to the calibration services described above, Thermometrics, Inc. can provide constants and/or computer generated tables of resistance versus temperature, for any of the equations given in the previous discussions.

Traceability

Temperature measurements at Thermometrics, Inc. are traceable to the International Temperature Scale of 1990 (ITS-90) as maintained by the National Institute of Standards and Technology (NIST). ITS-90 became the official international temperature scale as of January 1, 1990. It supersedes the International Practical Temperature Scale of 1968, amended edition of 1975 [ITS-68(75)]. The new international temperature scale was designed such that temperatures on this scale are in much better agreement with thermodynamic temperatures than the previous international temperature scales.

Traceability is achieved by means of triple point of water cells for the defining fixed point of 0.01°C (273.16K) and through the use of standard platinum resistance thermometers (SPRT's) which are calibrated at other fixed points at NIST. Resistance Traceability is achieved by means of standard resistors calibrated by NIST.

In the text of ITS-90, the standard platinum resistance thermometer is specified as the standard interpolation instrument for realizing the scale between the defining fixed points. The calibration services offered by Thermometrics cover the range of -140°C to +260°C.

The defining fixed points of ITS-90 with respect to this range are:

Defined Fixed Point	T_{90} (K)	t_{90} (°C)
Ar (Argon) triple point	83.8058	-189.3442
Hg (Mercury) triple point	234.3156	-38.8344
H ₂ O (Water) triple point	273.16	0.01
Ga (Gallium) melting point	302.9146	29.7646
In (Indium) freezing point	429.7485	156.5985
Sn (Tin) freezing point	505.078	231.928
Zn (Zinc) freezing point	692.677	419.527

Upon request, for a nominal fee, documentation for traceability to the National Institute of Standards and Technology can be furnished for all calibrations performed at Thermometrics.

Testing and Calibration of Thermistors

The very factors which make thermistors more useful than other temperature detectors, namely small size, fast response, and high sensitivity, also present problems in their testing and calibration. In general, thermistors and assemblies should be calibrated in a well-circulated temperature-controlled liquid bath. The bath liquid should be chosen to provide low electrical conductivity, low viscosity and high thermal conductivity. The liquid volume of the bath should be at least 1000 times the volume of the test fixture and assemblies that are placed in the bath. The heat capacity of the bath should be high enough so that the bath temperature is not changed significantly by the immersion of the thermistor fixture and assembly.

Thermistors are specified in terms of nominal resistance values at one or more discrete temperatures with stated tolerances on both the resistance and temperature. To properly evaluate whether or not a thermistor meets its specifications, it is necessary that the testing facility either pull their limits in (for manufacturers) or open their limits (for users) by the total measurement uncertainty. The total uncertainty includes both the temperature measurement uncertainty and the resistance measurement uncertainty.

Temperature Measurement Uncertainties

The factors which affect the temperature measurement uncertainty are:

Temperature Control of the Testing Medium

This can vary between $\pm 0.001^\circ\text{C}$ for a sophisticated precision laboratory bath to as much as $\pm 3^\circ\text{C}$ for bench top testing.

Accuracy and Precision of the Temperature Monitor

The temperature monitor can consist of any of the following units. The accuracy and stability of each unit is an important consideration. The reference works cited contain more detailed information regarding each type of temperature monitor.

- 1) Standard platinum resistance thermometer (SPRT). These standards have an uncertainty of about 0.001°C within the temperature ranges over which most thermistors are operated. [Reference: J.L. Riddle, G.T. Furukawa, and H.H. Plumb, "Platinum Resistance Thermometry", National Bureau of Standards Monograph 126 (April 1972), Available from U.S. Government Printing Office, Washington, DC, Stock No. 0303-01052, B. W. Mangum, "Platinum Resistance Thermometer Calibrations", NBS Special Publication 250-22, 1987, B.W. Mangum and G.T. Furukawa, "Guidelines for Realizing the International Temperature Scale of 1990 (ITS-90)", NIST Technical Note 1265, 1990.]
- 2) Thermistor temperature standards. Thermistor standards are available from Thermometrics, Inc. with accuracies that vary between 0.001°C and 0.01°C . [Reference: Product Data Section of this Catalog; Type "S", "AS", "ES" and "CSP".]
- 3) Precision mercury-in-glass thermometers for 0°C and the range of 24°C to 38°C . The maximum uncertainty associated with these thermometers is 0.03°C . [Reference: Mangum, B.W., and J.A. Wise, Standard Reference Materials: Description and Use of Precision Thermometers for the Clinical Laboratory, SRM 933 and SRM 934, NBS Special Publication 260-48 (May 1974), Available from US Government Printing Office, Washington, DC, SD Catalog No. C13.10:260-48.]
- 4) Resistance Temperature Detectors (RTD's). Platinum RTD's for commercial and industrial use (not SPRT's) are available with accuracies of $\pm 0.1^\circ\text{C}$ or $\pm 0.25^\circ\text{C}$. The stability and repeatability of some of the better RTD's on the market makes them suitable for calibration of individual units to within $\pm 0.01^\circ\text{C}$. Such units should be checked for stability and hysteresis prior to calibration.

- 5) Liquid-in-glass thermometers. Accuracies attainable with liquid-in-glass thermometers for various graduation intervals have been published by ASTM. Although accuracies in the range of $\pm 0.01^{\circ}\text{C}$ to $\pm 0.03^{\circ}\text{C}$ are shown for totally immersed thermometers under some conditions, the practical realization of accuracies better than $\pm 0.03^{\circ}\text{C}$ is very difficult to achieve. Typically, the accuracy of liquid-in-glass thermometers ranges between $\pm 0.1^{\circ}\text{C}$ and $\pm 0.5^{\circ}\text{C}$.
- 6) Thermocouples. A joint ANSI / ASTM specification lists the limits of error for thermocouples. The errors for various thermocouple types and temperature ranges are expressed in terms of a temperature accuracy or a per cent of reading, whichever is greater. As a result, the best accuracies one can expect from a thermocouple (special limits of error) are on the order of $\pm 0.5^{\circ}\text{C}$ to $\pm 1.1^{\circ}\text{C}$. Typically, the best accuracies obtained are on the order of 1.0°C to 2.2°C . [Reference: Standard Temperature-Electromotive Force (EMF) Tables for Thermocouples, ANSI/ASTM E220-77, ASTM Standards on Thermocouples, #06-5200077-40, p. 24, American Society for Testing and Materials (January 1978).]
- 7) Quartz thermometers. A quartz thermometer is also available which has a reported accuracy of $\pm 0.04^{\circ}\text{C}$ from -50°C to $+150^{\circ}\text{C}$ and $\pm 0.075^{\circ}\text{C}$ from -80°C to $+250^{\circ}\text{C}$. [Reference: Quartz Thermometer, Model 2804A, Test and Measurement Catalog, p. 427, Hewlett Packard Company (1991).]

Temperature Gradients Within the Medium

Of particular importance are temperature gradients between the thermistor under test and the temperature monitor (sensor). Such gradients can be minimized by using a well-stirred liquid bath. The thermal conductivity, and dielectric constant of the liquid should be high and its viscosity should be low.

Immersion Errors or Stem Effects for the Temperature Monitor

Generally, there is a heat-transfer path between the actual sensing element and the surrounding ambient environment which normally is at a different temperature than the calibration temperature. This can result in a monitor temperature that differs from the calibration medium by some factor. Unless the monitor has been calibrated for partial immersion, total immersion is recommended.

Self-heating Effects

For sensors, such as RTD's and thermistors, which require some power to be dissipated in the sensor during measurement, self-heating effects in the monitor must be considered.

Equipment Uncertainties

The uncertainties associated with any auxiliary equipment required for reading the monitor adds to the temperature uncertainty. For example, platinum SPRT's and RTD's have a temperature coefficient of resistance of about $0.4\%/^{\circ}\text{C}$. To realize a temperature uncertainty of 0.001°C with an SPRT, a precision 4-wire bridge is required which is capable of accurately resolving better than 1 PPM (preferably 1 part in 107). For such measurements, a ratio bridge is frequently used which compares the reading to a 4-terminal standard resistor. To realize a 0.01°C measurement with a platinum RTD, the resistance measuring equipment must have an accuracy which is better than 0.004% and preferably 0.001% . With a thermistor standard, a 0.01°C measurement requires an instrument having an accuracy of better than 0.04% and preferably at least 0.01% .

Thermal Response of Monitor

The difference between the response time of the monitor and the thermistor under test is a major consideration. This is particularly true when an attempt is made to calibrate a fast response thermistor such as a small bead. The thermal mass of the monitor has the property of integrating the temperature fluctuations of the test medium. It is possible for the monitor to indicate that there is only a slight fluctuation in the temperature of the medium while, in fact, the thermistor under test could be experiencing very large temperature fluctuations. To minimize this problem, the thermistor can be mass-loaded, or, a heat sink can be affixed to both the monitor and the unit under test. A thermal integrating block is often used for this purpose.

Heat Capacity of the Medium

The heat capacity of the test medium must be sufficiently large compared with that of the thermistor or thermistor assembly and its associated fixture so that the temperature of the test medium is not changed when they are immersed. When this is not the case, enough time must be permitted to elapse for the total system to reach an equilibrium condition, after immersion.

BOWTHORPE THERMOMETRICS
 Crown Industrial Estate, Priorswood Road
 Taunton, Somerset TA2 8QY UK
 Tel +44 (0) 1823 335200
 Fax +44 (0) 1823 332637

THERMOMETRICS, INC.
 808 US Highway 1
 Edison, New Jersey 08817-4695 USA
 Tel +1 (732) 287 2870
 Fax +1 (732) 287 8847

KEYSTONE THERMOMETRICS CORPORATION
 967 Windfall Road
 St. Marys, Pennsylvania 15857-3397 USA
 Tel +1 (814) 834 9140
 Fax +1 (814) 781 7969

Resistance Measurement Uncertainties

The factors which affect the resistance measurement uncertainty are:

Resistance Measuring Equipment

The accuracy, precision, stability, and temperature coefficient of the resistance measuring equipment must be considered.

Self-heating Error

The ratio of the power dissipated in the thermistor (by the test equipment) to the dissipation constant of the thermistor in the test medium determines the self-heat error.

Stability of the Thermistor Under Test

If a thermistor which has not had sufficient stability conditioning is calibrated at a low temperature and is subsequently calibrated at an elevated temperature, the high temperature exposure may create a shift in resistance which gives the appearance of a hysteresis effect. This may also occur if the thermistor is calibrated at a temperature above its maximum rated temperature.

Thermistor and Circuit Lead Resistance

In general, when the desired accuracy of the measurement requires a resistance resolution that is less than 1 Ohm, or when the absolute resistance of the thermistor at a specified temperature will be less than 1000 Ohms, the user must consider the following:

1. The contact resistance between the instrument and its measuring leads.
2. The contact resistance between the instrument leads and the fixture used to hold the thermistor.
3. The temperature coefficient of the instrument and measuring leads.
4. The resistance of the thermistor leads and the ability to make contact on the thermistor leads at exactly the same point each time a measurement is made. This is important when attempting to make measurements on thermistors with fine gauge platinum alloy lead wires such as small beads.

Thermal EMF Effects

Thermal EMF's can result at the instrument terminals, the connections between the instrument leads and the thermistor fixture, the connection between the fixture and the thermistor leads, and electrical connections between dissimilar metals within the fixture itself.

QUALITY ASSURANCE

Thermometrics maintains a system which complies with MIL-Q-9858. All of our bead and chip thermistors are designed to comply with MIL-PRF-23648. Every Thermometrics thermistor receives 100% electrical inspection as well as 100% visual and mechanical inspection. This is verified by additional QA sampling which varies with the application requirements (typically 0.65 AQL or 1.0 AQL). Our Applications Engineering Department will gladly provide assistance in selecting the best qualification and acceptance testing programs for any specific application. We can provide a low cost screening test or sophisticated qualification testing depending upon your requirements.

APPLICATIONS

The thermistor is a versatile component that can be used in a wide variety of applications where the measurand is temperature dependent.

Table I gives a partial listing of thermistor applications which are grouped according to one of the three fundamental electrical characteristics: the resistance-temperature characteristic, the voltage-current characteristic, and the current-time characteristic. The current-time and voltage-current characteristics are associated with self-heated thermistors. The resistance-temperature characteristic is applicable to thermistors operated with negligible self-heat.

Applications which depend on the resistance-temperature characteristic include temperature measurement, control, and compensation. Also included are those applications for which the temperature of the thermistor is related to some other physical phenomena. An example would be the use of thermistor type cardiac catheters for thermodilution studies. With this type of device, a saline or dextrose solution, having a known volume and temperature, is injected into the blood stream through one of the catheter lumens. The solution mixes with the blood and is diluted as

it is carried downstream past a thermistor located at the surface of another catheter lumen. At the thermistor location, the temperature of the blood-injectate mixture is measured over a period of time. The cardiac output (efficiency) is computed from the temperature-time response data. Another example is an hypsometer, an instrument in which the temperature of a boiling fluid is used to determine the pressure to which the fluid is exposed.

Applications based on the voltage-current characteristic of a thermistor generally involve changes in the environmental conditions or circuit variations which, in turn, result in changes in the operating point on any given curve or family of curves.

The current-time characteristic of a thermistor depends on its heat capacity and dissipation constant as well as the circuit in which it is used. Applications which make use of the current-time characteristic include time delay and surge suppression.

NTC THERMISTOR APPLICATIONS

The NTC thermistor is a versatile component that can be used in a wide variety of applications where the measured is temperature dependent. Table <3> gives a partial listing of thermistor applications that are grouped according to one of the three fundamental electrical characteristics; the current-time characteristics, the voltage-current characteristic, and the resistance-temperature characteristic.

Applications based on the voltage-current characteristic generally involve changes in the environmental conditions or the electrical circuit parameters of a self-heated thermistor. In turn, these changes will result in a shift of the operating point on any given voltage-current curve or family of such curves. These applications are further subdivided into four major categories depending on the type of excitation that causes the operating point to change.

Table 3: NTC Thermistor Applications.

APPLICATIONS BASED ON R-vs-T CHARACTERISTIC:

General Industrial Applications

Industrial process controls
Plastic laminating equipment
Hot glue dispensing equipment
Auto & truck tire curing
Fiber processing & manufacturing
Pyrometers (non-contact)
Photographic processing
Copy machines
Soldering irons (controlled)
Hot mold equipment (thermoplastics)
Solar energy equipment

Consumer / Household Appliances

Thermostats
Small appliance controls
Burglar alarm detectors
Oven temperature control
Refrigeration and air conditioning
Fire detection

Medical Applications

Fever thermometers
Dialysis equipment
Rectal temperature monitoring
Myocardial probes
Esophageal tubes
Skin and muscle temperature
Thermodilution catheters
Respiration rate measurement
Blood analysis equipment
Respirators
Hypodermic needle probes
Fluid temperature

Instrumentation Applications

Motor winding compensation
Infrared sensing compensation
Instrument winding compensation

Automotive and Transportation Applications

Emission controls
Differential temperature controls
Fire protection and safety equipment
Engine temperatures
Aircraft temperatures
Rotor/bearing temperatures

Laboratory and Scientific Applications

Temperature standards
Chemical analysis
Oceanographic research
Meteorology
Bathythermography
Calorimetry
Titration studies
Geological temperature studies
Spectrophotometry
Bolometry
Osmometers

Food Handling Applications

Fast food processing
Perishable shipping
Oven temperature control
Food storage
Coffee makers
Freezing point studies

High Reliability Applications

Missiles & spacecraft temperatures
Aircraft temperature
Submarines & underwater monitoring
Fire control equipment

Communications Applications

Transistor temperature compensation
Gain stabilization
Piezoelectric temperature compensation

APPLICATIONS BASED ON E-vs-I CHARACTERISTIC

Group 1 = change in Dissipation Constant

Vacuum manometers
Anemometers
Flow meter
Liquid level control / alarm
Fluid velocity
Thermal conductivity analysis
Gas detection / analysis

Group 3 = change in Ambient Temperature

Temperature control
Alarm indication

Group 2 = change in Electrical Parameters

Automatic gain / level control
Amplitude control
Voltage regulation
Volume limiting
Signal expansion / compression
Switching devices

Group 4 = change in Radiation Absorbed

RF / Microwave power measurement

APPLICATIONS BASED ON CURRENT-TIME CHARACTERISTIC

Time delay devices
Sequential switching

Surge suppression
Inrush current limiting

BOWTHORPE THERMOMETRICS
Crown Industrial Estate, Priorswood Road
Taunton, Somerset TA2 8QY UK
Tel +44 (0) 1823 335200
Fax +44 (0) 1823 332637

THERMOMETRICS, INC.
808 US Highway 1
Edison, New Jersey 08817-4695 USA
Tel +1 (732) 287 2870
Fax +1 (732) 287 8847

KEYSTONE THERMOMETRICS CORPORATION
967 Windfall Road
St. Marys, Pennsylvania 15857-3397 USA
Tel +1 (814) 834 9140
Fax +1 (814) 781 7969

Applications Based on Current-Time Characteristic

Time delay, surge suppression, inrush current limiting and sequential switching represent some of the earliest, high volume uses of thermistors. These thermistor applications are all based upon the current-time characteristic which was described in the section on Electrical Properties. The current-time characteristic of a thermistor depends on its heat capacity and dissipation constant as well as the circuit in which it is used.

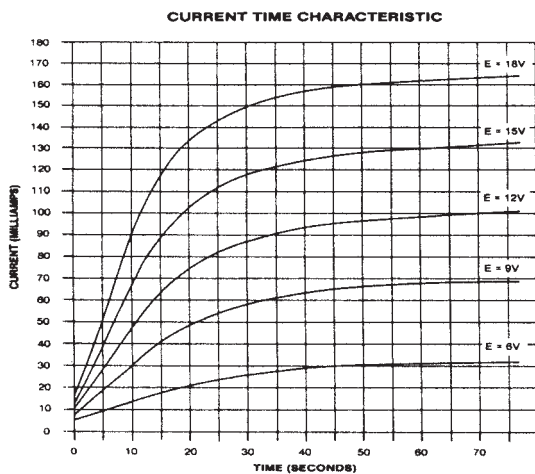
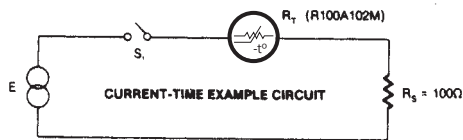

Figure 9: Example of current-time delay circuit.

The thermistor current-time characteristic can be used to discriminate against high voltage spikes of short duration and against initial current surges. Typical surge protection applications involve the protection of filaments in vacuum tubes or light bulbs, or the protection of circuit elements that are connected in series with switching power supplies.

When filaments are cold they have a low resistance and so the initial current at "turn-on" can be high. This current surge can shorten the useful life of the filament. When a switching power supply is first turned on, the large filter capacitors will attempt to quickly charge. This large inrush current can cause circuit breakers to trip, fuses to blow or contacts in relays and switches to weld. When a

thermistor is connected in the circuit, however, the initial current will be low due to the high resistance of the thermistor. As the thermistor self-heats, its resistance will decrease and the current gradually increases in the circuit thus protecting the filaments or sensitive circuit elements.

Thermistors can be designed so that their initial resistance and heat capacity are sufficiently large enough to discriminate against high-voltage surges of short duration. In this matter, the time delay characteristic of thermistors can be used to prevent false triggering voltages. This suppression may be accomplished without interfering with the normal operation of the devices at lower voltages.

Applications involving sequential switching involve the use of two or more time delay circuits. The circuits can involve series or parallel combinations of thermistors and loads and are designed such that the individual thermistor-load combinations operate in a prescribed sequence. The choice of thermistor and circuit parameters determine the time delays and thus the sequence of events.

In all applications based upon the current-time characteristics, proper consideration must be given to the peak instantaneous power applied to the thermistor. The thermistor may be damaged if voltage, current or power ratings of the device are exceeded.

Applications Based on Voltage-Current Characteristic

All applications based on the voltage-current characteristic use one or more thermistors which are operated in a self-heated, steady state condition. In the section on Electrical Properties, we described the static voltage-current characteristic. This characteristic can be expressed mathematically, by equation (7) and can be graphically plotted on log-log coordinates, Figure <5>, or on linear coordinates Figure, <6>.

The applications based on the voltage-current characteristic shown in Table <3> were subdivided into four major categories depending on the type of excitation that causes the operating point to change.

The operating point is defined as the intersection of the voltage-current characteristic and the load line. The load line is obtained by considering the Thevenin equivalent circuit with respect to the thermistor terminals. The excitations, either thermal or electrical, will cause either the voltage-current characteristic or the load line to shift. The result is that a new operating point is established for a steady state condition.

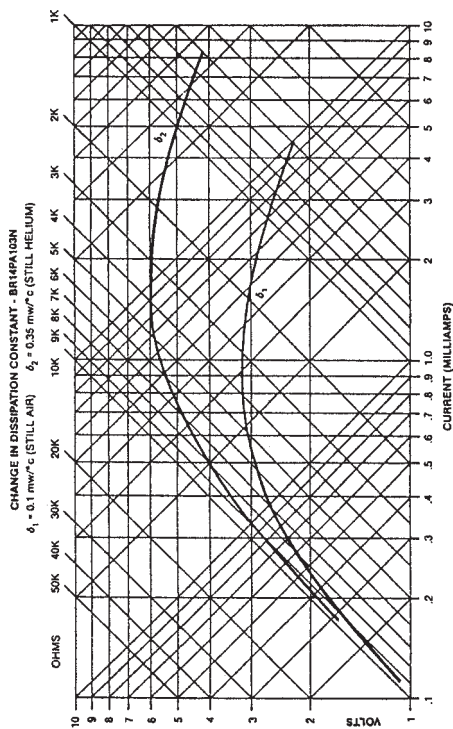

Figure 10: E-I Characteristics with changes in Dissipation Constant.

Log-log coordinates are generally used to display the voltage-current characteristic in manufacturers' data sheets and they are useful for demonstrating the effects of a given type of excitation. Linear coordinates are generally more useful when trying to solve an actual circuit problem where a load line intersects a voltage-current characteristic curve or family of such curves.

In the Group 1 category of Applications based on the E-I Characteristic shown in Table <3>, a change in the heat-transfer properties of the thermistor environment results in a change in the thermistor dissipation constant and a resultant shift in the voltage-current characteristic curve. The operating point therefore changes to the intersection of the load line with the shifted curve. This change in the dissipation constant can be produced by a change in the heat transfer from the thermistor to its surroundings, by a change in the thermal conductivity of the medium or by a change in the relative motion of the medium in which the thermistor is suspended. The effect of the change in dissipation constant is to translate the voltage-current characteristic along a line of constant resistance since the ambient temperature and the zero-power

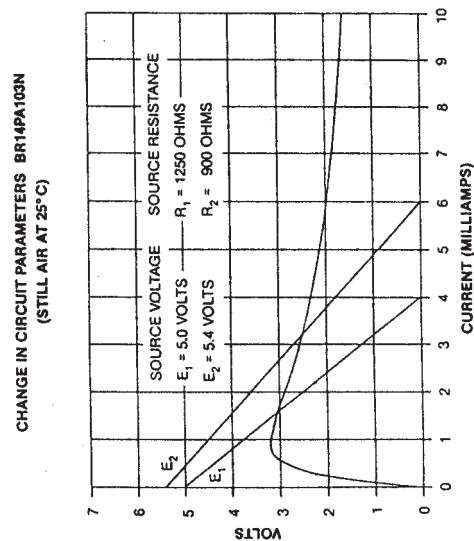

Figure 11: E-I Characteristics with changes in Electrical Parameters.

resistance of the thermistor have not changed. For a constant amount of power applied, however, the temperature rise above ambient will be changed by a factor equal to the ratio of the change in dissipation constants. Figure <10> illustrates this type of excitation.

In the Group 2 category of Applications based on the E-I Characteristic shown in Table <3>, the excitation is electrical and can be represented as a change in the Thevenin voltage or resistance (or both) at the thermistor terminals. This results in a rotation and/or translation (or both) of the load line with respect to the fixed voltage-current characteristic of the thermistor. For reasons of clarity, this type of excitation is almost always plotted on linear coordinates. Figure <11> illustrates this type of excitation.

In the Group 3 category of Applications based on the E-I Characteristic shown in Table <3>, the excitation is thermal which results in a change in the voltage-current characteristic curve. If the source resistance is a non-self-heated thermistor, the load line may also shift. Figure <12> illustrates this type of excitation.

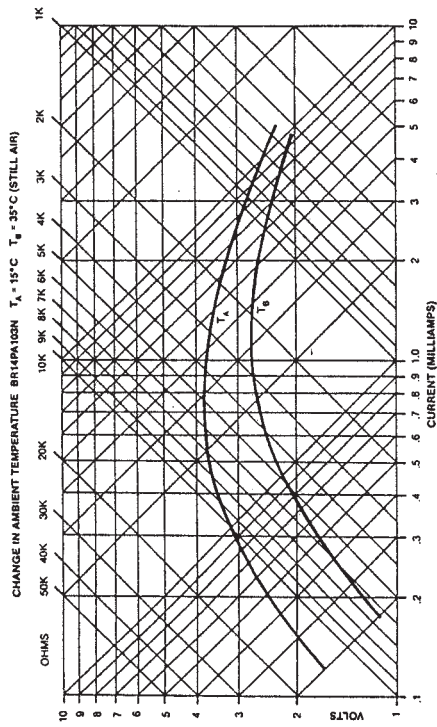

Figure 12: E-I Characteristics with changes in Ambient Temperature.

It appears as if the voltage-current characteristic has been translated along a line of constant power, however, this is not correct. The R-T characteristic is non-linear and so the voltage-current characteristic curves must be generated for the new ambient temperature conditions.

In the Group 4 category of Applications based on the E-I Characteristic shown in Table <3>, the excitation is a change in radiation absorbed by the thermistor. The operating point has caused shift in the same manner as if the temperature is changed. Figure <13> illustrates this type of excitation.

In all of the applications involving self-heated thermistors, consideration must be given to the maximum power ratings of the thermistor utilized. Excessive power levels can cause degradation of the thermistor or possibly even catastrophic failure.

Particular consideration must be given to the type mounting. The heat transfer properties of the thermistor will be affected by the way the thermistor is mounted and will therefore show up as a change in the dissipation constant. For many of the applications, it is desirable to have the thermistor suspended in such a fashion that it is isolated from the mount as much as possible. As an example,

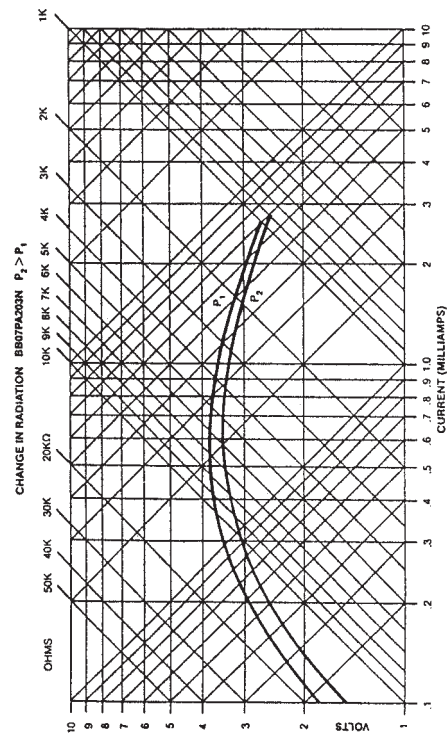

Figure 13: E-I Characteristics with changes in Absorbed Radiation.

thermistor beads are suspended by their leadwires across a gap on a header or fixture for gaseous environments and long probes are used for immersion in liquid environments.

Applications Based on Resistance-Temperature Characteristic

Applications that are based upon the resistance-temperature characteristics include temperature measurement, control, and compensation. Also included are those applications for which the temperature of the thermistor is related to some other physical phenomena. Unlike the application based upon the current-time or voltage-current characteristics, these applications require that the thermistor be operated in a zero-power condition.

In the previous treatment of the Resistance-Temperature Characteristic, data was presented on the derivation of interpolation equations that can be used for NTC thermistors. The various equations discussed, when used under the proper set of conditions, can adequately and accurately define the zero-power resistance-temperature characteristic of the NTC thermistors.

There are a variety of instrumentation / telemetry circuits in which a thermistor may be used for temperature measurements. In most cases, a major criterion is that the circuit provides an output that is linear with temperature. When the use of a constant-current source is desired, the circuit used should be a two-terminal network that exhibits a linear resistance-temperature characteristic. The output of this network is a linear voltage-temperature function. Under these conditions, a digital voltmeter connected across the network can display temperature directly when the proper combination of current and resistance level are selected. If the use of a constant voltage source is more desirable, the circuit used should be a two-terminal network that exhibits a linear conductance-temperature characteristic. Conversely, the output of this network is a linear current-temperature function.

Consequently, the design of thermistor networks for most instrumentation / telemetry applications is focused on creating linear resistance-temperature or linear conductance-temperature circuits.

Linear Voltage Divider

The simplest thermistor network used in many applications is the voltage divider circuit shown in Figure <14>. In this circuit, the output voltage is taken across the fixed resistor. This has the advantages of providing an increasing output voltage for increasing temperatures and allows the loading effect of any external measurement circuitry to be included into the computations for the resistor, R , and thus the loading will not affect the output voltage as temperature varies.

The output voltage as a function of temperature can be expressed as follows:

$$e_o (T) = e_s \left[\frac{R}{(R + R_T)} \right] \quad (23)$$

From the plot of the output voltage, we can observe that a range of temperatures exists where the circuit is reasonably linear with good sensitivity. Therefore, the objective will be to solve for a fixed resistor value, R , that provides optimum linearity for a given resistance-temperature characteristic and a given temperature range.

A very useful approach to the solution of a linear voltage divider circuit is to normalize the output voltage with respect to the input voltage. The result will be a standard output function (per unit volt) that can be used in many design problems.

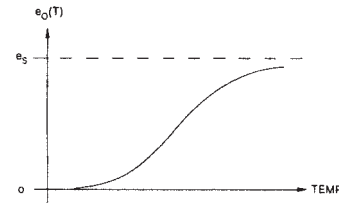
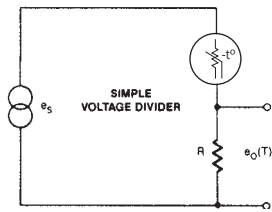

Figure 14: Simple Voltage Divider.

For the case of the voltage divider circuit under consideration, we obtain the normalized output from equation (23) as follows:

$$\frac{e_o (T)}{e_s} = \frac{R}{(R + R_T)} = \frac{1}{1 + \left[\frac{R_T}{R} \right]} \quad (24)$$

R_T has been defined as zero-power resistance of a thermistor at a temperature, T , and, R_{T0} as the zero-power resistance of a thermistor at a standard reference temperature, T_0 . In most thermistor literature, the reference temperature, T_0 , is 25°C (298.15K) and the thermistors are cataloged by their nominal resistance value at 25°C. The usual practice is to furnish resistance ratio versus temperature information for each type of thermistor and material system (composition of metal oxides) listed in the catalog. Thus, the thermistor resistance is normalized with respect to its resistance at the specified temperature.

$$r_T = R_T / R_{T0} \quad \therefore \quad r_T R_{T0} = R_T \quad (25)$$

Note: In the actual solution of many applications problems, it is desirable for T_0 and R_{T0} to be specified at the midpoint of the intended operating temperature range.

The ratio of the zero-power resistance of the thermistor at the desired reference temperature to the fixed value resistor in the voltage divider circuit is a constant which we shall call "s". Thus we have:

$$S = \frac{R_{T0}}{R} \quad (26)$$

By substitution, we obtain the standard function as follows:

$$F(T) = \frac{e_o(T)}{e_s} = \frac{1}{1 + sr_T} \quad (27)$$

The standard function, $F(T)$, is dependent upon the circuit constant, “s”, and the resistance-ratio versus temperature characteristic, r_T . If we allow the circuit constant to assume a series of constant values and solve for the standard function, we shall generate a family of “s” curves. Figure <15> illustrates a family of such curves. These curves were generated using the resistance-ratio temperature characteristic given for the “A” material system as defined in MIL-PRF-23648D.

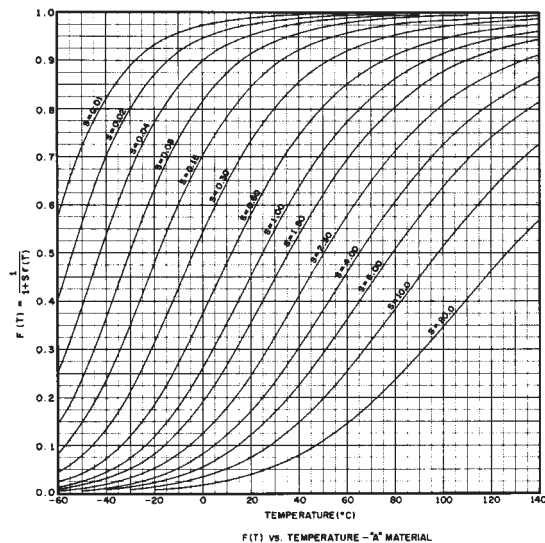

Figure 15: Design curves for “A” Material System (MIL-PRF-23648D).

It is obvious from the design curves that a value for the circuit constant, “s”, exists such that optimum linearity can be achieved for the divider network over a specified temperature range. The design curves can be used to provide a graphical solution or a first approximation for many applications. For the best solution to a design problem, however, an analytical approach is required. There are two analytical methods employed to solve for the

optimum linearity conditions of the divider network. They are the “Inflection Point Method” and the “Equal Slope Method”.

Inflection Point Method

In this method, it is desired to have the inflection point of the standard function occur at the midpoint of the operating temperature range. The inflection point is the point where the slope of the curve is a maximum. The sensitivity of the divider network would therefore be at a maximum at this point. This method is recommended for the solution of temperature control applications.

This method, however, does not provide good linearity over wide temperature ranges. Its use should be restricted to temperature spans that are narrow enough for beta to be considered constant and thus the intrinsic equations can be used.

At the inflection point, the slope of the standard curve (first derivative with respect to temperature) is at a maximum and the curvature (second derivative with respect to temperature) is zero. The reference temperature will be selected as the midpoint temperature of the desired operating range.

Equal Slope Method

In this method it is desired to set the slopes of the standard function equal to each other at the endpoints of the temperature range (T_L and T_H). This method can provide good linearity over wider temperature ranges. When using this method for solution, the polynomial equations for the resistance-temperature characteristic are used. Specifically, equations (15) through (18) provide suitable interpolation accuracies for most linearized network applications.

Both of the analytical methods discussed above have been based on a single thermistor voltage divider. When the thermistor is connected to more complex circuits which contain only resistances and voltage sources, the problem can be reduced back to the simple voltage divider by considering the Thevenin equivalent circuit as seen at the thermistor terminals. As a short refresher, the Thevenin voltage is the open circuit voltage across the thermistor terminals and the Thevenin resistance is the resistance as seen by the thermistor with the voltage source short circuited.

Modified Voltage Divider Circuit

Figure <16> shows two simple modifications to the basic voltage divider which can be converted to or from a Thevenin equivalent circuit as required for any given application.

The voltage divider of Figure <16a> is used where it is desired to reduce the output signal while Figure <16b> is used where it is desired to reduce the source voltage and translate the output signal by adding a bias voltage.

Of the two circuits, Figure <16b> is more commonly used, especially in bridge circuits. It permits the use of conventional source voltages and reduces the voltage placed across the thermistor to an acceptable level of self-heating. The bias voltage can be compensated in the bridge design.

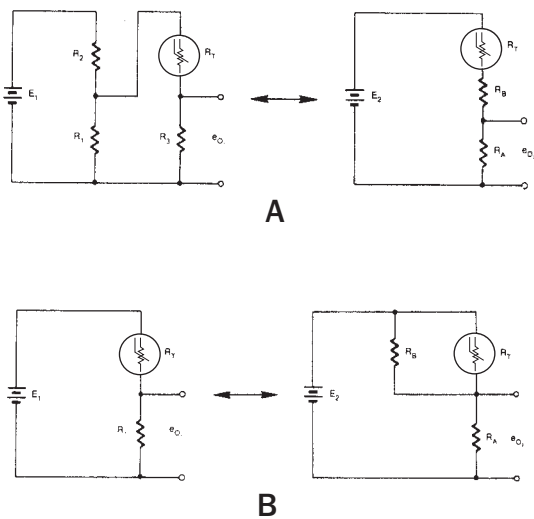

Figure 16: Modified Voltage Divider Circuits.

Bridge Circuit

Bridge circuits are actually two voltage divider circuits. In most applications, the bridge consists of a linear thermistor voltage divider and a fixed resistor voltage divider. For differential temperature applications, the bridge consists of matching thermistor linear voltage dividers. Figure <17a> illustrates a basic Wheatstone Bridge circuit with one linearized thermistor voltage divider and Figure <17b> illustrates the Wheatstone Bridge circuit used for differential temperature applications. Both of the circuits in Figure <17> represent cases where the load resistance is infinite and thus does not affect the output voltage of the voltage divider or dividers.

When the Wheatstone Bridge circuit is more complex and the load resistance cannot be considered infinite, the Thevenin theorem is used to reduce the circuit to its equivalent form. Figure <18a> shows the basic Wheatstone Bridge circuit for a finite load resistance, while Figure <18b> shows the Thevenin equivalent circuit.

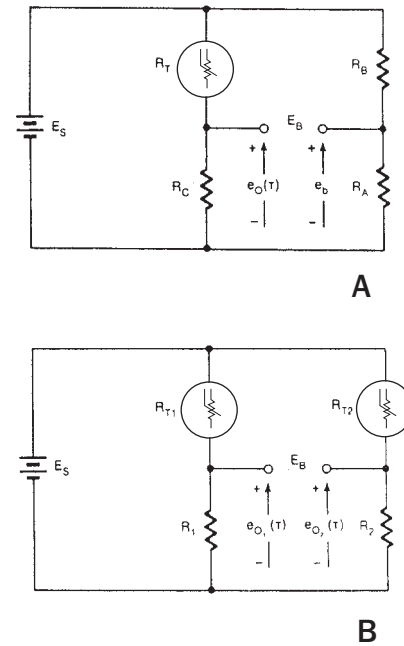

Figure 17: Wheatstone Bridge Circuits (Infinite Load).

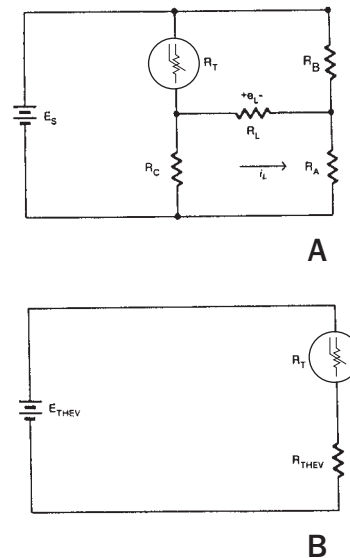

Figure 18: Wheatstone Bridge Circuits (Finite Load).

Ohmmeter Circuit

Another circuit which is commonly employed in temperature measurement applications is the basic Ohmmeter circuit which is shown in Figure <19>. This circuit is also a basic voltage divider of sorts. It is generally used for low cost temperature measurement applications; thus, the trimming potentiometer may not always be in the circuit.

In the Ohmmeter circuit, the objective is to produce a linear current. This current can be expressed as a constant times the standards function, $F(T)$. The value of the constant is the source voltage divided by the circuit resistance as seen by the thermistor. Note that the circuit consisting of a thermistor in series with a fixed resistance is a linear conductance versus temperature network.

The voltage divider circuits, the Wheatstone Bridge circuits and the Ohmmeter circuit discussed so far have all been examples of linear conductance versus temperature networks. They may all be solved by the use of the standard function "s" curves, the inflection point method or the equal slope method as preferred.

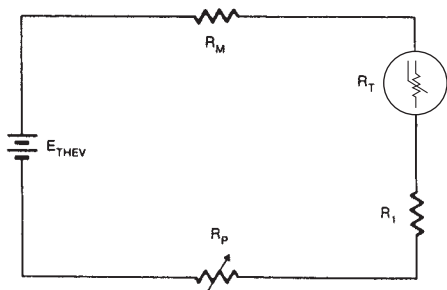

Figure 19: Ohmmeter Circuit.

Linear Resistance Networks

Many applications based upon the resistance-temperature characteristic require the use of a linearized resistance network. Among the most common applications are networks to compensate for the positive temperature coefficient resistance changes of devices and circuits as well as coil windings in relays, motors, instrument movements or generators. Another important area of applications involve the need for a voltage which has a negative slope with respect to temperature in order to compensate for temperature drifts of amplifiers, oscillators or other circuits containing active components.

The linear conductance-temperature networks are driven by a constant voltage source, whereas, the linear resistance-temperature networks will be driven by a constant current source. Note that one is the dual of the other.

Figure <20> illustrates the basic linear resistance-temperature networks used in most compensation applications. The simplest network is obviously that shown in Figure <20a>. If we normalize the network resistance with respect to the shunt resistor, we observe that the standard function, $F(T)$, can be used for the design of linear resistance networks.

In order to increase the overall network resistance to a higher value, a series resistor can be inserted as illustrated by Figure <20b>. This can also be done to increase the voltage drop across the network when a constant current is applied to the terminals. Obviously, the linear resistance-temperature characteristic is translated by the series resistor and the slope remains unchanged.

Figure <20c> shows the circuit of Figure <20b> with the addition of a resistor in series with the thermistor. This circuit is used to permit the use of a standard value for the thermistor. The standard value thermistor must be slightly lower than the desired value for optimum linearity and both thermistors must have the same resistance ratio-temperature characteristic.

Figure <20d> shows the basic circuit of Figure <20a> with the addition of a resistor in series with the thermistor, again for the purpose of utilizing a standard value of thermistor.

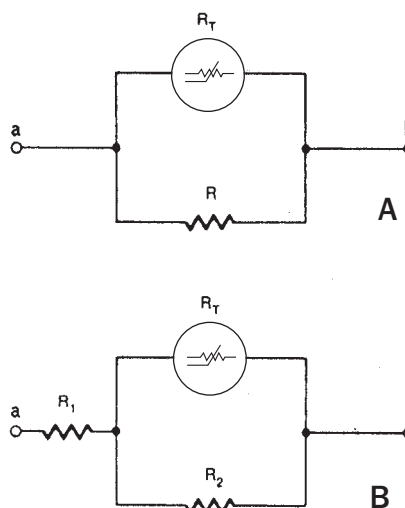

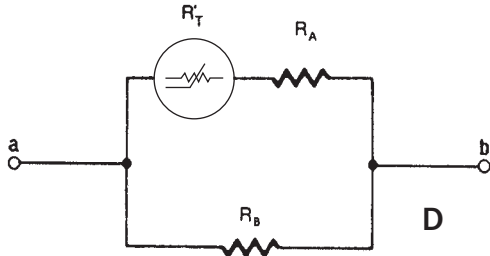
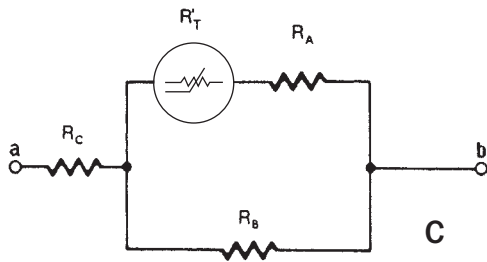

Figure 20: Linear Resistance Networks.

Multiple Thermistor Networks

There is a practical limit to obtaining linearized voltage divider or linearized resistance networks using a single thermistor. In order to obtain better linearization over wider temperature spans, two or more thermistors are sometimes used in combination with resistor networks. Figure <21> illustrates two and three thermistor networks, respectively.

The analytical solutions for these multiple thermistor networks are too complex for presentation. The usual procedure is to obtain the optimum solution by means of a computer model of the desired circuit and an iterative program. Based upon the temperature range and desired circuit characteristics, a reasonably good first approximation can be made for circuit element values. The computer will then adjust the element values incrementally and examine the results until an optimum network is achieved.

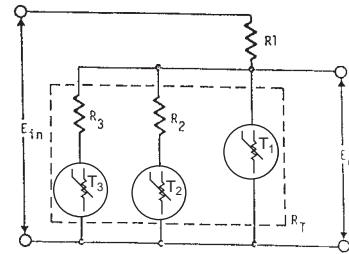
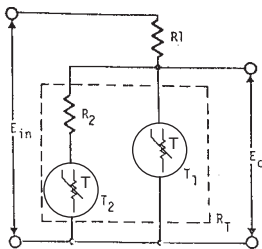

Figure 21: Multiple Thermistor Networks.

Digital Instrumentation

To date, a major limitation to the use of thermistors for resistance thermometry has been the non-linearity of the resistance-temperature characteristic. Even a carefully designed linear voltage divider circuit or a linear resistance network can only operate over a relatively narrow range of temperatures before the non-linearity errors become significant. Generally speaking, the wider the temperature span, the more non-linearity one must be willing to accept. In order to handle the wide temperature ranges of some applications, it is often necessary to provide range switches on the analog instrument. In this manner, the overall temperature range can be broken down into smaller segments and the voltage divider or bridge circuits can be optimized for each of the smaller temperature ranges. This approach is not always convenient when a continuous readout is desired for the time-temperature characteristic of a process or experiment.

In the past few years, digital thermometers for thermistor sensors have been introduced that display the measured temperature over relatively wide ranges and have accuracies that were not possible with the analog instruments. The digital thermometers can also be equipped with output options (BCD, RS-232C, GPIB, etc.) so that the temperature data can be networked to computers, data-loggers, or continuous process controllers.

The basic voltage divider circuit or Wheatstone Bridge circuit is still utilized to provide an analog input stage for these instruments. For example, a constant current source may be used in conjunction with a linear-resistance network, or, a constant voltage source may be used in conjunction with a linear-conductance network. However, the linearity of the analog signal is no longer a major consideration since the data is now processed with the aid of microprocessor circuits.

The input signal from the thermistor transducer circuit first is amplified and/or linearized as required and fed to an A/D (analog to digital) converter. The output of the A/D converter is now a digital signal that can be operated upon by the instrument microprocessor chip. The overall precision of the A/D converter will be a major determining factor in the overall system accuracy. That is to say, a 16 bit A/D is better than a 14 bit A/D converter. There are many possible combinations of microprocessor chips and software programming which can be used for the digital thermometer. There will be high cost or low cost solutions that are dictated by the accuracy requirements of the particular thermistor application.

An example of a low cost instrument is the hand-held type thermometer that is designed to work with an interchangeable thermistor. In this type of instrument, the resistance-temperature curve of the interchangeable device is known over the desired temperature range and is stored in a ROM (read only memory) chip. Each of the thermistor sensors designed to be used with the instrument are interchangeable to the same resistance-temperature curve. Thus, the accuracy of the instrument is basically determined by the interchangeability of the individual sensors. This is usually specified in the form of a temperature accuracy over a given temperature range. The typical accuracy for this type of hand held thermometer is on the order of $\pm 0.1^{\circ}\text{C}$ to $\pm 0.2^{\circ}\text{C}$ over the specified temperature range, which is usually 0°C to 100°C .

High accuracy digital thermometers are currently available as bench-type instruments. These instruments are not dedicated to a particular R-T characteristic such as the hand-held thermometers. These instruments are usually programmable so that they can work with any thermistor whose resistance-temperature characteristic has been defined over a specified temperature range. Major features of this class of digital thermometer include: memory portions of the instrument that are both RAM (random access memory) as well as ROM, and, I/O options (input/output ports) to interface with displays, keypads, CRT's, printers, etc.

These resistance-temperature characteristics of each thermistor must first be determined by calibration at selected reference temperatures over the desired operating range. The test data is then used to compute the constants for one of the standard thermistor curve fitting equations. The accuracy of these digital thermometers will thus be dependent upon the exactness of fit of the thermistor R-T data using the equation. The equation interpolation error is, in turn, a function of the accuracy of the initial calibration data points as well as the temperature range.