

1.0 AMP. Surface Mount Rectifiers

M1---M7

FEATURES

- For surface mounted application
- Low forward voltage drop
- High current capability
- Easy pick and place
- High surge current capability
- Plastic material used carries Underwriters
- Laboratory Classification 94V-0 260°C / 10 seconds at terminals

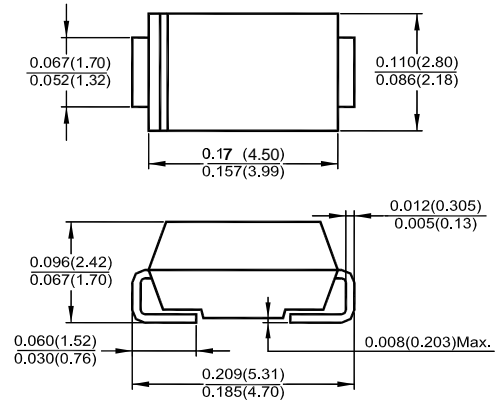

Dimensions in inches and (millimeters)
DO-214AC (SMA)

MECHANICAL DATA

- Case: Molded plastic DO-214AC
- Terminals: Pure tin plated, lead free solderable per J-STD-002B and JESD22-B102D.
- Polarity: Indicated by cathode band
- Packaging: 12mm tapeper EIA STD RS-481
- Weight: 0.064 gram

MAXIMUM RATINGS AND ELECTRICAL CHARACTERISTICS

Ratings at 25 °C ambient temperature unless otherwise specified. Single phase, half wave, 60 Hz, resistive or inductive load. For capacitive load, derate current by 20%.

Parameter	Symbols	M1	M2	M3	M4	M5	M6	M7	Unit
Maximum Repetitive Peak Reverse Voltage	VRRM	50	100	200	400	600	800	1000	V
Maximum RMS Voltage	VRMS	35	70	140	280	420	560	700	V
Maximum DC Blocking Voltage	VDC	50	100	200	400	600	800	1000	V
Maximum Average Forward Rectified Current at $T_L = 100^\circ\text{C}$	$I(A)$	1							A
Peak Forward Surge Current 8.3ms Single Half Sine-wave Superimposed on Rated Load (JEDEC)	IFSM	30							A
Maximum Instantaneous Forward Voltage at 1 A	VF	1.1							V
Maximum DC Reverse Current $T_A = 25^\circ\text{C}$ at Rated DC Blocking Voltage $T_A = 125^\circ\text{C}$	IR	5 200							μA
Typical Junction Capacitance ¹⁾	CJ	15							pF
Maximum Thermal Resistance ²⁾	R JL	30							$^\circ\text{C}/\text{W}$
Operating and Storage Temperature Range	TJ, TS	- 50 to + 150							$^\circ\text{C}$

1) Measured at 1MHz and applied reverse voltage of 4 V
2) 8 mm² (0.013 mm thick) land areas

M1---M7 Typical Characteristics

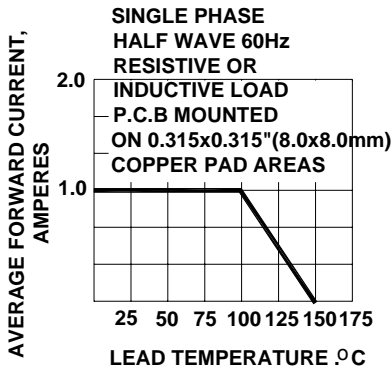

Fig. 1-FORWARD CURRENT DERATING CURVE

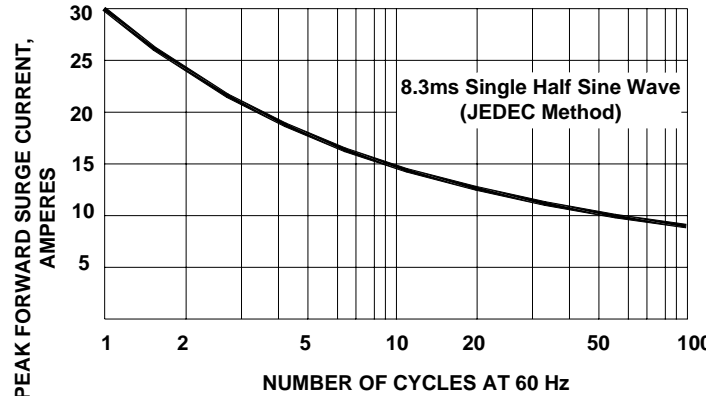

Fig. 2-MAXIMUM NON-REPETITIVE PEAK FORWARD SURGE CURRENT

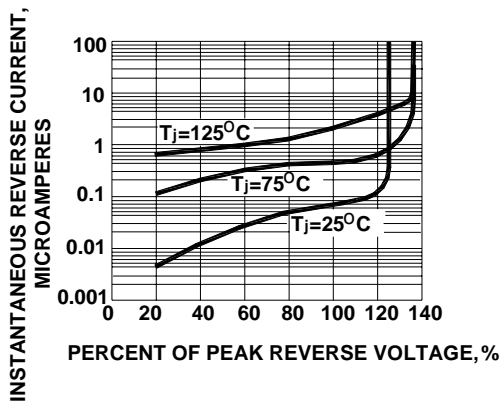

Fig. 3-TYPICAL REVERSE CHARACTERISTICS

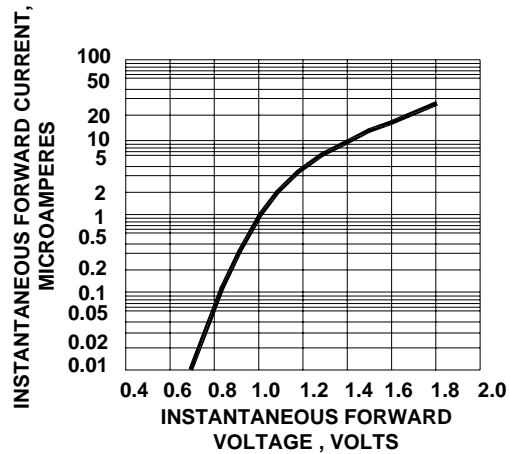

Fig. 4-TYPICAL INSTANTANEOUS FORWARD CHARACTERISTICS

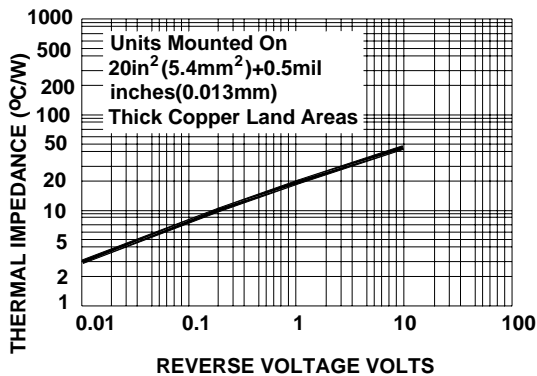

Fig. 5-TRANSIENT THERMAL IMPEDANCE

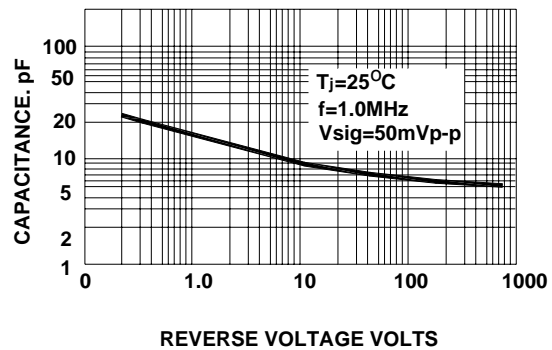

Fig. 6-TYPICAL JUNCTION CAPACITANCE