

Connect the "BOOT" direct to the GND or power to need a jumper here

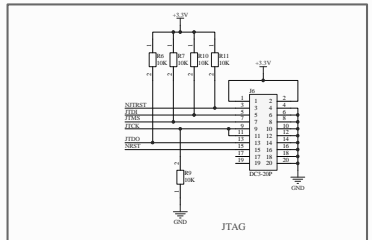

JTAG

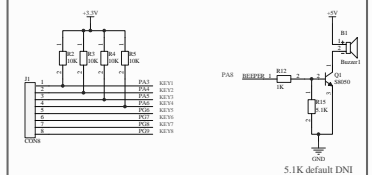

5.1k default DNI

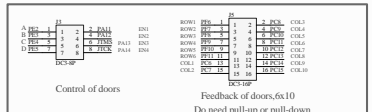

Control of doors Feedback of doors, 6x10 Do need pull-up or pull-down

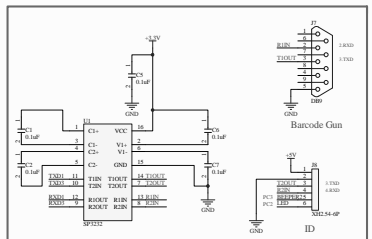

Barcode Gun

V+ don't connected same as datasheet, need double confirm take care of pins of RXD and TXD

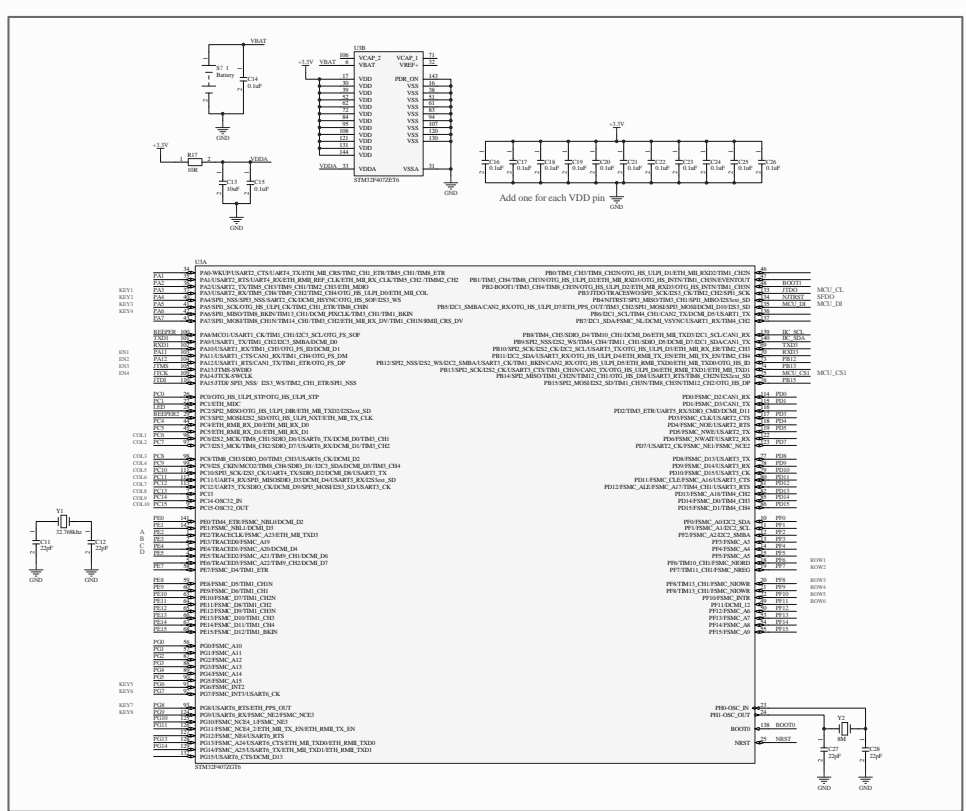

Add one for each VDD pin

Connect to the LCD

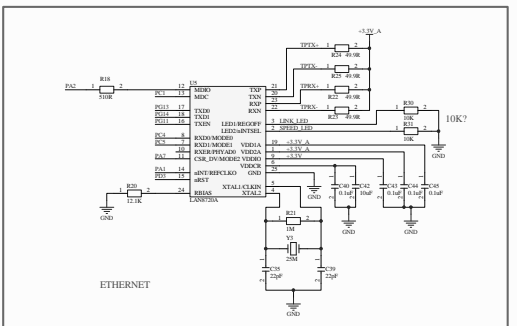

ETHERNET

the value of resistor?

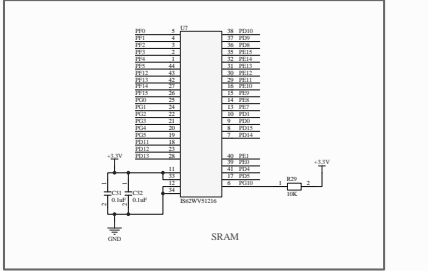

SRAM

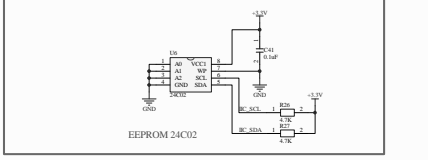

EEPROM 24C02

No.	Number	Revision
1	2015.11	1.00
2	2016.01	1.01