

**Description**

The P6KE series is designed specifically to protect sensitive electronic equipment from voltage transients induced by lightning and other transient voltage events.

**Features**

- I Fast response time
- I Matte tin lead-free Plated
- I Low incremental surge resistance
- I Halogen free and RoHS compliant
- I Typical  $I_R$  less than  $1\mu A$  above 12V
- I Compatible with industrial standard package DO-15
- I For surface mounted applications to optimize board space
- I 600W peak pulse power capability with at 10/1000 $\mu s$  waveform, repetition rate (duty cycle): 0.01%
- I High temperature soldering guaranteed:260°C/10 seconds



**Electrical symbol**

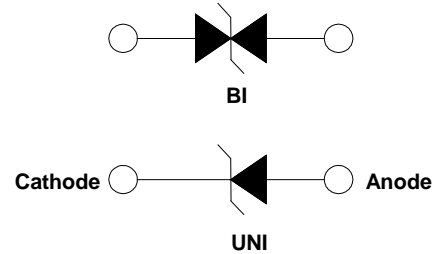

**Part Number Code**

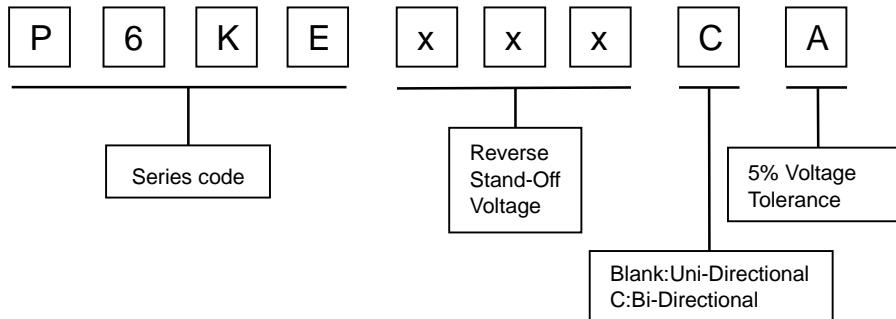

**Mechanical Characteristics**

Rating	Symbol	Value	Units
Peak Pulse Power Dissipation by 10x1000 $\mu s$ test Waveform(Fig.2) (Note1)	$P_{PP}$	600	W
Steady State Power Dissipation on infinite heat sink at $T_L=75^\circ C$ (Fig.6)	$P_D$	5.0	W
Peak Forward Surge Current, 8.3ms Single Half Sine Wave Unidirectional only (Note 2)	$I_{FSM}$	100	A
Maximum instantaneous forward voltage at 25 A for unidirectional only	$V_F$	3.5/6.5	V
Operating junction and Storage Temperature Range.	$T_J, T_{STG}$	-55 to 150	$^\circ C$

Notes:

1. Non-repetitive current pulse , per Fig. 4 and derated above  $T_A = 25^\circ C$  per Fig. 3.
2. Measured on 8.3ms single half sine wave or equivalent square wave, duty cycle=4 pulses per minute maximum.



## Electrical Characteristics

Type Number		Reverse Stand-Off Voltage	Breakdown Voltage		Test Current	Max. Clamping Voltage 10/1000µs	Max. Peak Pulse Current 10/1000µs	Reverse Leakage
			$V_{BR} @ I_T$					
		UNI	BI	$V_{RWM}$	Min	Max	$I_T$	$V_C @ I_{PP}$
		V	V	V	mA	V	A	µA
P6KE6.8A	P6KE6.8CA	5.80	6.45	7.14	10	10.5	57.0	1000
P6KE7.5A	P6KE7.5CA	6.40	7.13	7.88	10	11.3	53.0	500
P6KE8.2A	P6KE8.2CA	7.02	7.79	8.61	10	12.1	50.0	200
P6KE9.1A	P6KE9.1CA	7.78	8.65	9.55	1	13.4	45.0	50
P6KE10A	P6KE10CA	8.55	9.50	10.50	1	14.5	41.0	10
P6KE11A	P6KE11CA	9.40	10.50	11.60	1	15.6	38.0	5
P6KE12A	P6KE12CA	10.20	11.40	12.60	1	16.7	36.0	5
P6KE13A	P6KE13CA	11.10	12.40	13.70	1	18.2	33.0	1
P6KE15A	P6KE15CA	12.80	14.30	15.80	1	21.2	28.0	1
P6KE16A	P6KE16CA	13.60	15.20	16.80	1	22.5	27.0	1
P6KE18A	P6KE18CA	15.30	17.10	18.90	1	25.2	24.0	1
P6KE20A	P6KE20CA	17.10	19.00	21.00	1	27.7	22.0	1
P6KE22A	P6KE22CA	18.80	20.90	23.10	1	30.6	20.0	1
P6KE24A	P6KE24CA	20.50	22.80	25.20	1	33.2	18.0	1
P6KE27A	P6KE27CA	23.10	25.70	28.40	1	37.5	16.0	1
P6KE30A	P6KE30CA	25.60	28.50	31.50	1	41.4	14.4	1
P6KE33A	P6KE33CA	28.20	31.40	34.70	1	45.7	13.2	1
P6KE36A	P6KE36CA	30.80	34.20	37.80	1	49.9	12.0	1
P6KE39A	P6KE39CA	33.30	37.10	41.00	1	53.9	11.2	1
P6KE43A	P6KE43CA	36.80	40.90	45.20	1	59.3	10.1	1
P6KE47A	P6KE47CA	40.20	44.70	49.40	1	64.8	9.30	1
P6KE51A	P6KE51CA	43.60	48.50	53.60	1	70.1	8.60	1
P6KE56A	P6KE56CA	47.80	53.20	58.80	1	77.0	7.80	1
P6KE62A	P6KE62CA	53.00	58.90	65.10	1	85.0	7.10	1
P6KE68A	P6KE68CA	58.10	64.60	71.40	1	92.0	6.50	1
P6KE75A	P6KE75CA	64.10	71.30	78.80	1	103.0	5.80	1
P6KE82A	P6KE82CA	70.10	77.90	86.10	1	113.0	5.30	1
P6KE91A	P6KE91CA	77.80	86.50	95.50	1	125.0	4.80	1
P6KE100A	P6KE100CA	85.50	95.00	105.00	1	137.0	4.40	1
P6KE110A	P6KE110CA	94.00	105.00	116.00	1	152.0	4.00	1
P6KE120A	P6KE120CA	102.00	114.00	126.00	1	165.0	3.60	1
P6KE130A	P6KE130CA	111.00	124.00	137.00	1	179.0	3.30	1



**Electrical Characteristics**

Type Number		Reverse Stand-Off Voltage	Breakdown Voltage		Test Current	Max. Clamping Voltage 10/1000µs	Max. Peak Pulse Current 10/1000µs	Reverse Leakage
			$V_{BR} @ I_T$					
		UNI	BI	$V_{RWM}$	Min	Max	$I_T$	$V_C @ I_{PP}$
		V	V	V	mA	V	A	µA
P6KE150A	P6KE150CA	128.00	143.00	158.00	1	207.0	2.90	1
P6KE160A	P6KE160CA	136.00	152.00	168.00	1	219.0	2.70	1
P6KE170A	P6KE170CA	145.00	162.00	179.00	1	234.0	2.60	1
P6KE180A	P6KE180CA	154.00	171.00	189.00	1	246.0	2.40	1
P6KE200A	P6KE200CA	171.00	190.00	210.00	1	274.0	2.20	1
P6KE220A	P6KE220CA	185.00	209.00	231.00	1	328.0	1.83	1
P6KE250A	P6KE250CA	214.00	237.00	263.00	1	344.0	1.75	1
P6KE300A	P6KE300CA	256.00	285.00	315.00	1	414.0	1.45	1
P6KE350A	P6KE350CA	300.00	332.00	368.00	1	482.0	1.25	1
P6KE400A	P6KE400CA	342.00	380.00	420.00	1	548.0	1.10	1
P6KE440A	P6KE440CA	376.00	418.00	462.00	1	602.0	1.00	1
P6KE500A	P6KE500CA	427.50	475.00	525.00	1	690.0	0.87	1
P6KE520A	P6KE520CA	444.60	494.00	546.00	1	717.6	0.84	1
P6KE550A	P6KE550CA	470.30	522.50	577.50	1	759.0	0.79	1
P6KE600A	P6KE600CA	513.00	570.00	630.00	1	828.0	0.72	1

**I-V Curve Characteristics**

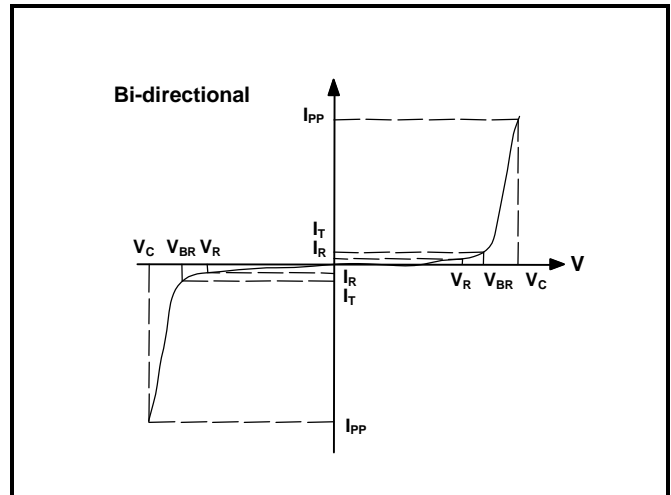
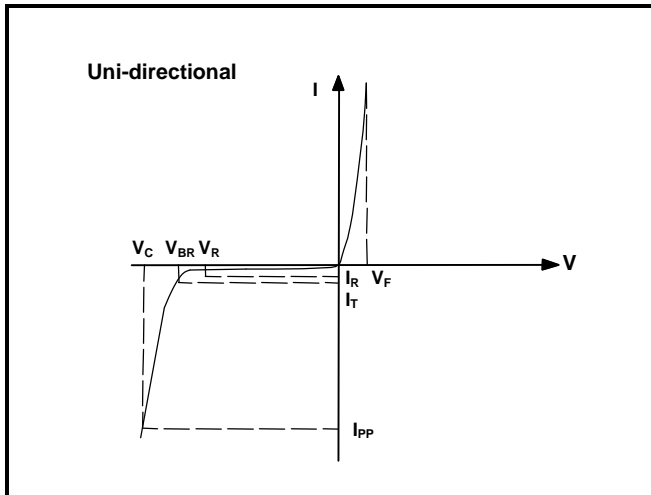

$P_{PPM}$  Peak Pulse Power Dissipation -- Max power dissipation

$V_R$  Stand-off Voltage -- Maximum voltage that can be applied to the TVS without operation

$V_{BR}$  Breakdown Voltage -- Maximum voltage that flows though the TVS at a specified test current ( $I_T$ )

$V_C$  Clamping Voltage -- Peak voltage measured across the TVS at a specified  $I_{ppm}$  (peak impulse current)

$I_R$  Reverse Leakage Current – Current measured at  $V_R$

$V_F$  Forward Voltage Drop for Uni-directional



Ratings and Characteristic Curves ( $T_A=25^\circ\text{C}$  unless otherwise noted)

Figure 1 - TVS Transients Clamping Waveform

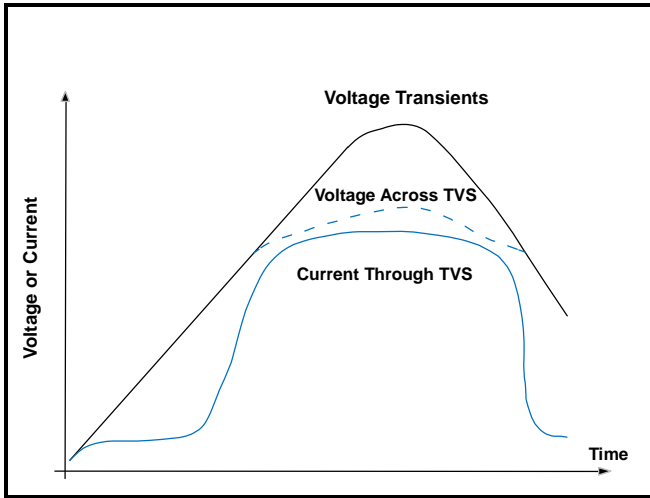

Figure 2 - Peak Pulse Power Rating Curve

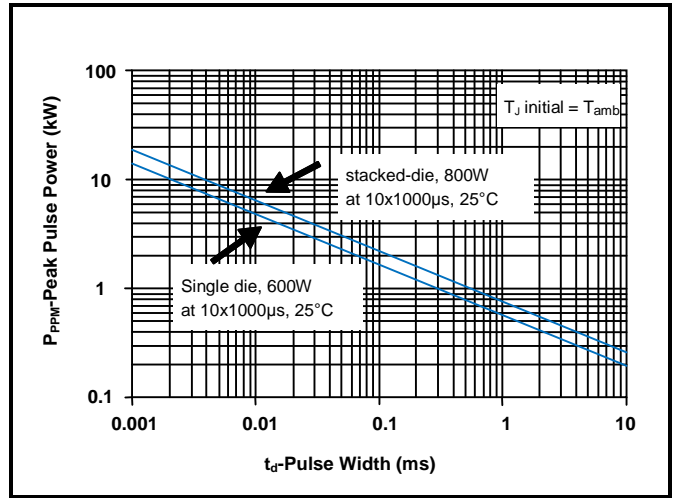

Figure 3 - Pulse Derating Curve

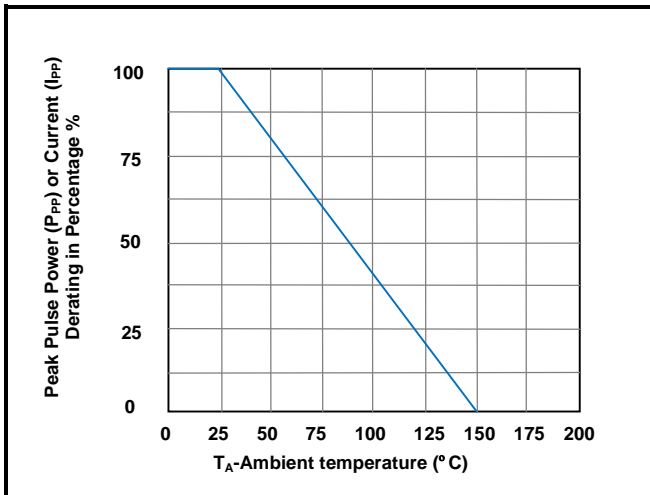

Figure 4 - Pulse Waveform

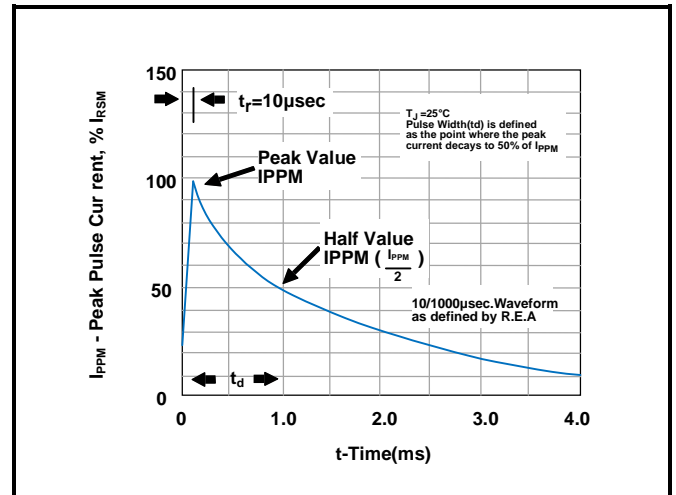

Figure 5 - Typical Junction Capacitance

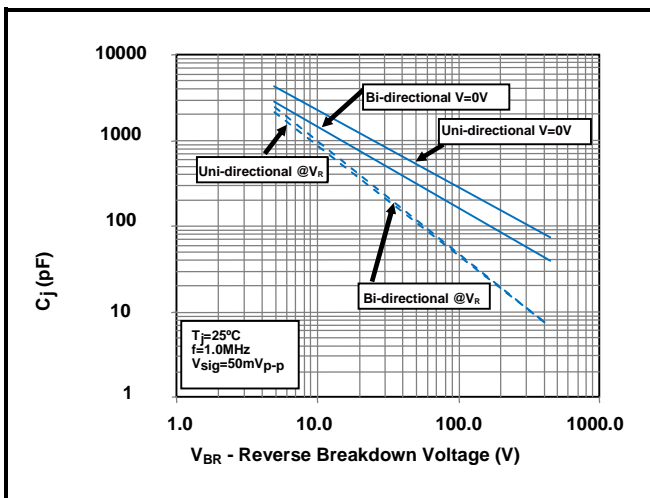

Figure 6 - Steady State Power Derating Curve

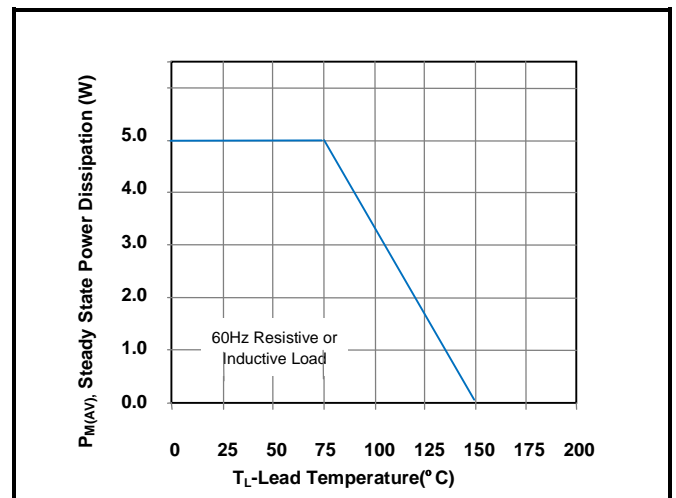
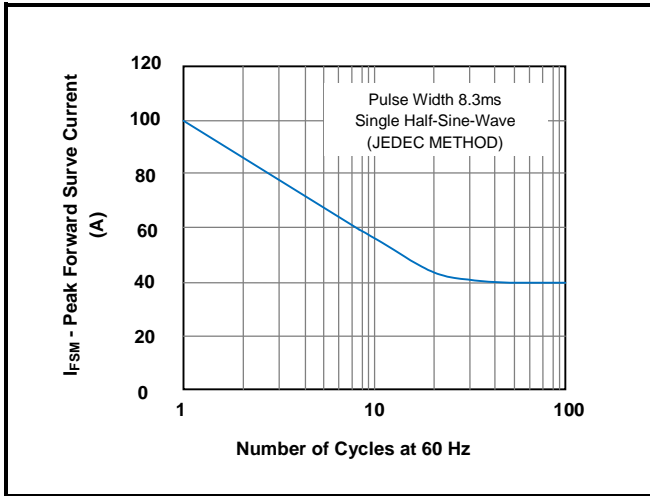
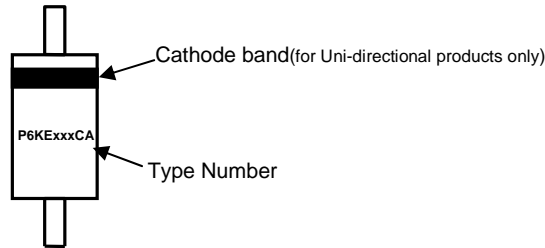

Figure 7 - Maximum Non-Repetitive Surge Current



Part Marking System



Dimensions

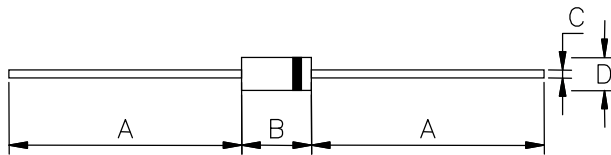

DIM	Millimeters		Inches	
	Min	Max	Min	Max
A	25.40	-	1.000	-
B	5.80	7.60	0.228	0.299
C	0.70	0.90	0.028	0.035
D	2.60	3.60	0.102	0.142



Taping and Reel Specifications

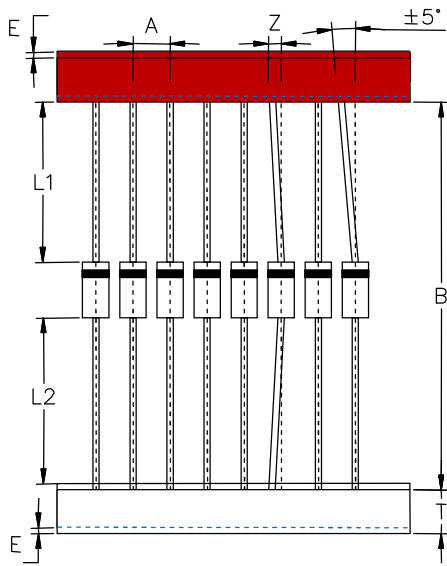

Symbol	Millimeters	Inches
A	5.08±0.5	0.2±0.019
B	53.0±1.0	2.087±0.039
Z	1.2Max	0.047 Max
T	6.0±0.4	0.236±0.015
E	0.8Max	0.031 Max
L1-L2	1.0Max	0.039 Max

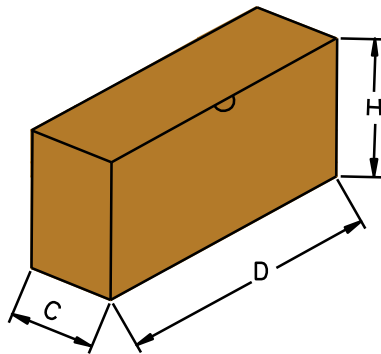

Symbol	Millimeters	Inches
D	250.0±5.0	9.843±0.197
C	75.0±5.0	2.953±0.197
H	114.0±5.0	4.488±0.197
Quantity	2000PCS / inner box	

