



# ORIENT

## Photocoupler

### Product Data Sheet

Name: MOC302X

Customer: \_\_\_\_\_

Date: \_\_\_\_\_

### 1. Features

- (1) Isolation voltage between input and output  $V_{iso}$  : 5,000V rms
- (2) 6pin non zero-cross optoisolators triac driver output
- (3) High repetitive peak off-state voltage  $V_{DRM}$  : Min. 600V
- (4) High critical rate of rise of off-state voltage(  $dV/dt$  : MIN. 1000V / s )
- (5) Dual-in-line package : MOC3020, MOC3021, MOC3022, MOC3023
- (6) Wide lead spacing package : MOC3020M, MOC3021M, MOC3022M, MOC3023M
- (7) Surface mounting package : MOC3020S, MOC3021S, MOC3022S, MOC3023S
- (8) Tape and reel packaging : MOC3020S-TA, MOC3021S-TA, MOC3022S-TA, MOC3023S-TA, MOC3020S-TA1, MOC3021S-TA1, MOC3022S-TA1, MOC3023S-TA1

### 2. Description

The MOC302X consists of a non zero crossing photo triac, optically coupled to a gallium arsenide infrared emitting diode. The MOC302X is housed in the DIP6 package and guarantees insulation thickness. Therefore, the MOC302X meets the reinforced insulation class requirements of international safety standards.

### 3. Application Range

- AC Motor Drives
- AC Motor Starters
- Static power switch
- Lighting Controls
- Solenoid/Valve Controls
- Solid State Relays
- Temperature Controls

### 4. Absolute Maximum Ratings ( $T_a=25^{\circ}C$ )

Parameter		Symbol	Rated Value	Unit
Input	Forward Current	$I_F$	50	mA
	Junction Temperature	$T_J$	125	$^{\circ}C$
	Reverse Voltage	$V_R$	6	V
	Power Dissipation	P	100	mW
Output	Off-State Output Terminal Voltage	$V_{DRM}$	400	V
	Peak Repetitive Surge Current (PW=1ms, 120 pps)	$I_{TSM}$	1	A
	Junction Temperature	$T_J$	125	$^{\circ}C$
	Collector Power Dissipation	$P_C$	300	mW
Total Power Dissipation		$P_{tot}$	330	mW
*1 Insulation Voltage		$V_{iso}$	5000	$V_{rms}$
Working Temperature		$T_{opr}$	-40 ~ + 100	$^{\circ}C$
Deposit Temperature		$T_{stg}$	-55 ~ + 150	
*2 Soldering Temperature		$T_{sol}$	260	

Notes:

\*1 AC for 1 minute, R.H.= 40 ~ 60% R.H. In this test, pins 1, 2&3 are shorted together, and pins 4, 6 are shorted together.

\* 2 For 10 seconds

**5. Electrical Optical Characteristics at Ta=25°C**

Parameter		Symbol	Condition	Min	Typ.*	Max	Unit	
Input	Forward Voltage	$V_F$	$I_F=20mA$	---	1.2	1.6	V	
	Reverse Current	$I_R$	$V_R=6V$	---	0.05	10	$\mu A$	
Output	1.Peak Blocking Current, Either Direction	$I_{DRM}$	$V_{DRM} = 400V$	---	10	100	nA	
	Peak On-State Voltage, Either Direction	$V_{TM}$	$I_{TM}=100mA$ Peak	---	1.7	3.0	V	
	2.Critical rate of Rise of Off-State Voltage	dv/dt	$V_{in}=240V_{rms}$	1000	---	---	V/us	
Couple	3.Led Trigger Current,Current Required to Latch Output, Either Direction	MOC3020	$I_{FT}$	Main Terminal Voltage = 3V	---	---	30	mA
		MOC3021			---	---	15	
		MOC3022			---	---	10	
		MOC3023			---	---	5	
	Holding Current, Either Direction		$I_H$		---	200	---	$\mu A$

\*1. Test voltage must be applied within dv/dt rating.

\*2. This is static dv/dt. Commutating dv/dt is a function of the load-driving thyristor(s) only.

\*3. All devices are guaranteed to trigger at an  $I_F$  value less than or equal to max  $I_{FT}$  .

Therefore, recommended operating  $I_F$  lies between max  $I_{FT}$  , 30 mA for MOC3020, 15 mA for MOC3021, 10 mA for MOC3022, 5 mA for MOC3023, and absolute max  $I_F$  (50mA).

## 6.Naming Rule

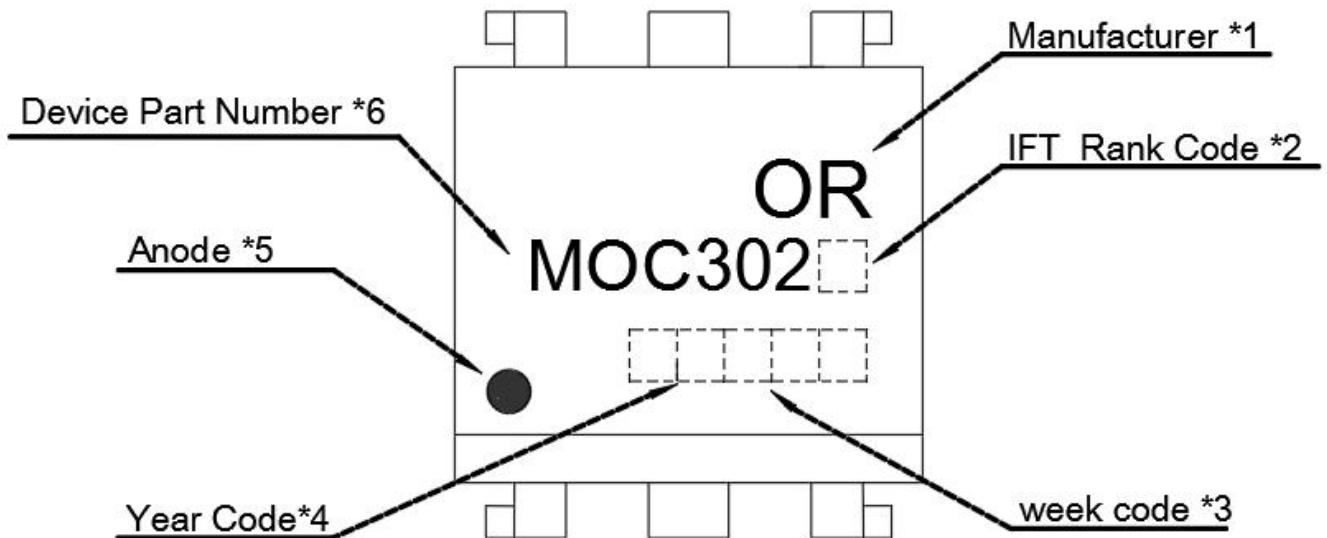

### NOTE:

- (1) Manufacturer denotes Shenzhen Orient Tech Ltd . Co ., Ltd.
- (2) □ denotes IFT Rank Code ,0=MOC3020; 1=MOC3021; 2=MOC3022; 3=MOC3023.
- (3) □□ denotes Week code.
- (4) □□□ denotes Year code.
- (5) ● denotes Anode.
- (6) MOC302 denotes Device Part Number.
- (7) Unit:mm

### 7. Package Dimension

(1).MOC302X

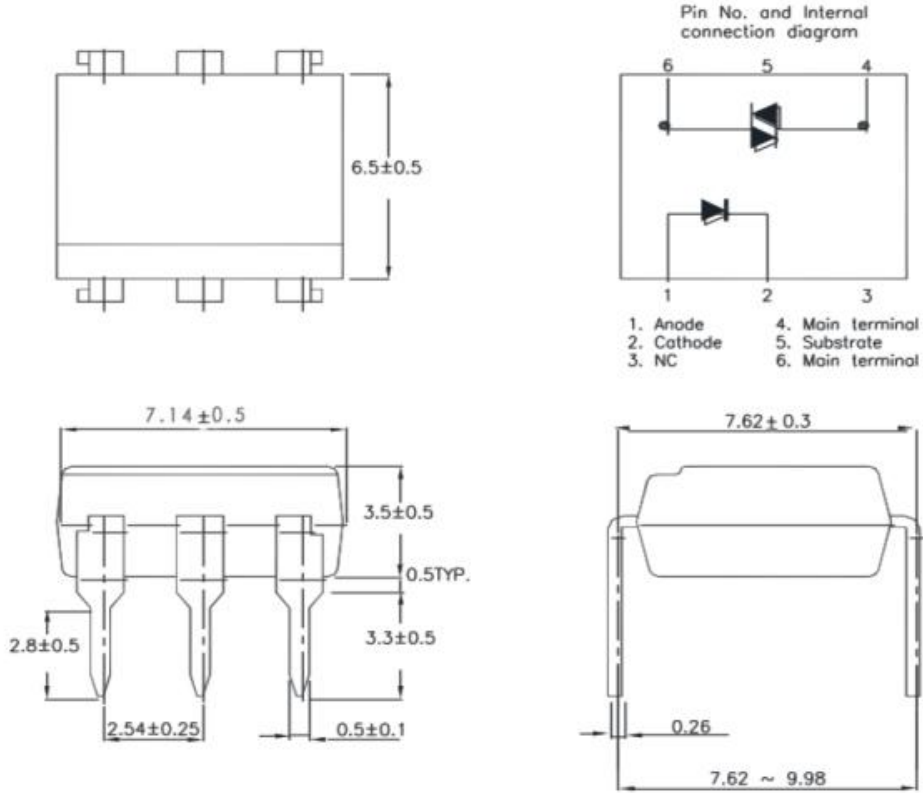

(2).MOC302X M

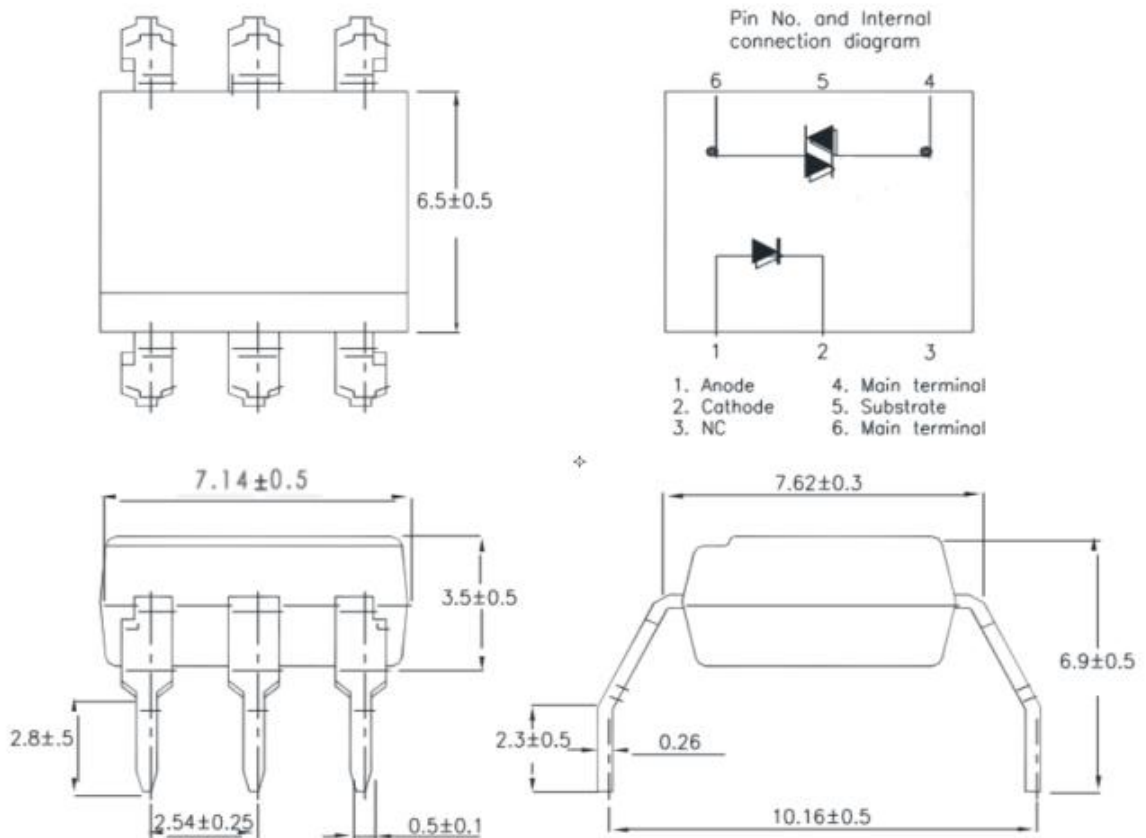

(3). MOC302X S

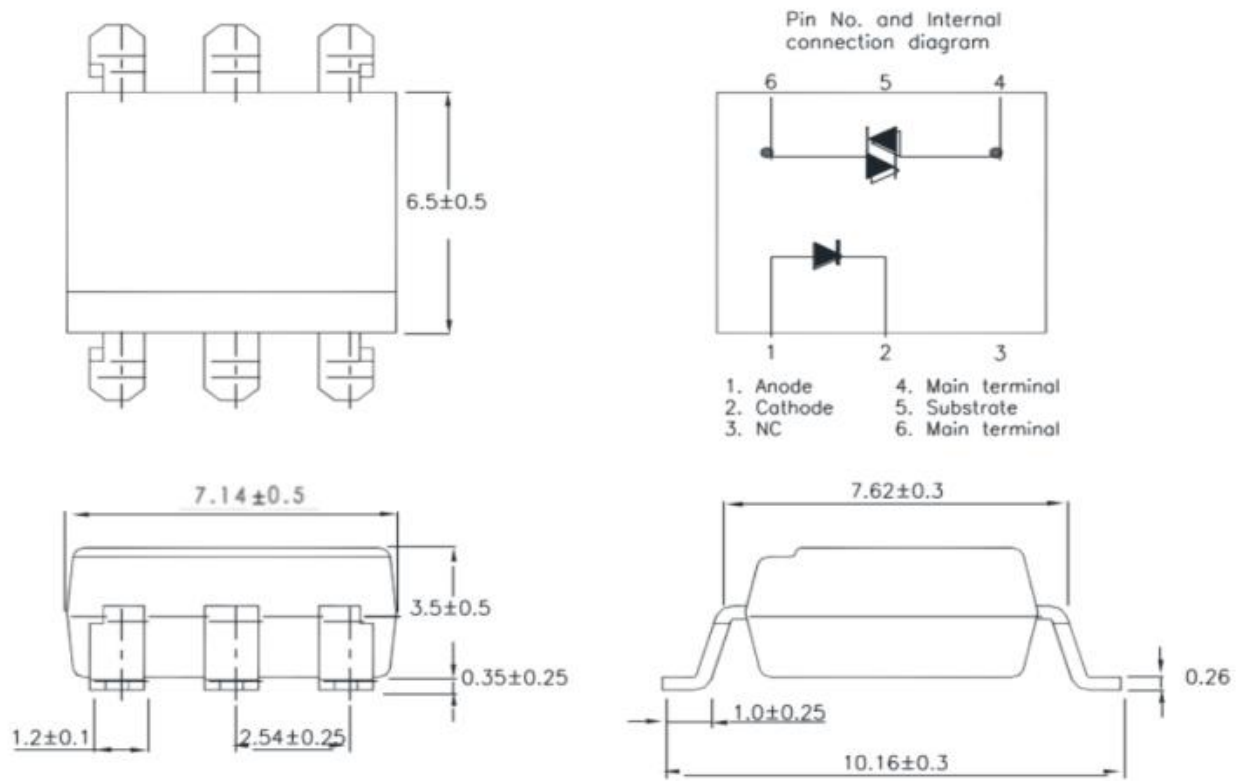

8. Taping Dimensions

(1). MOC302XS-TA

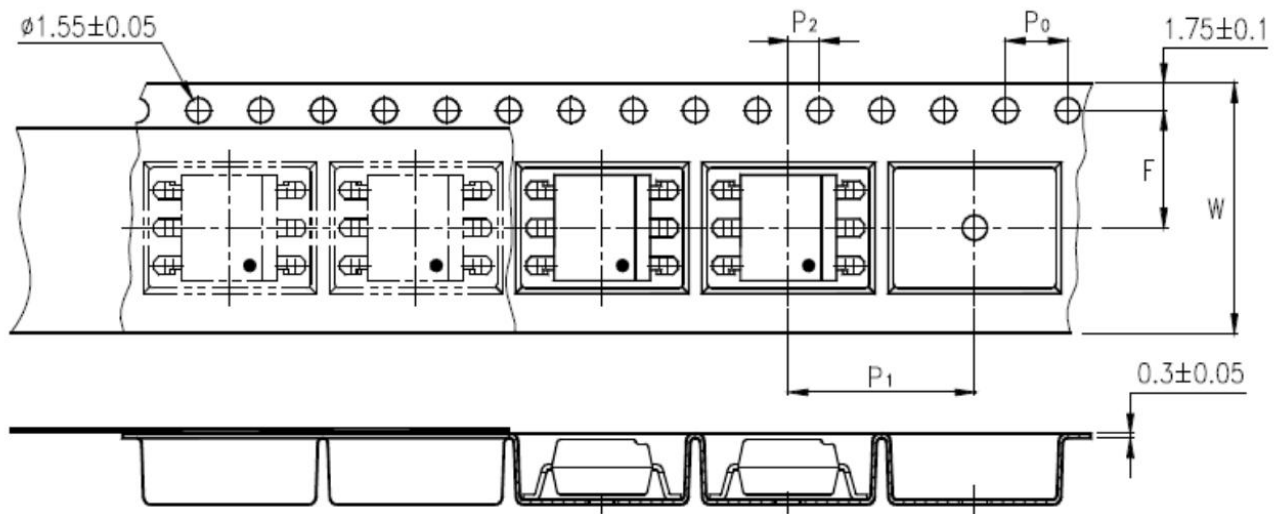

(2). MOC302XS-TA1

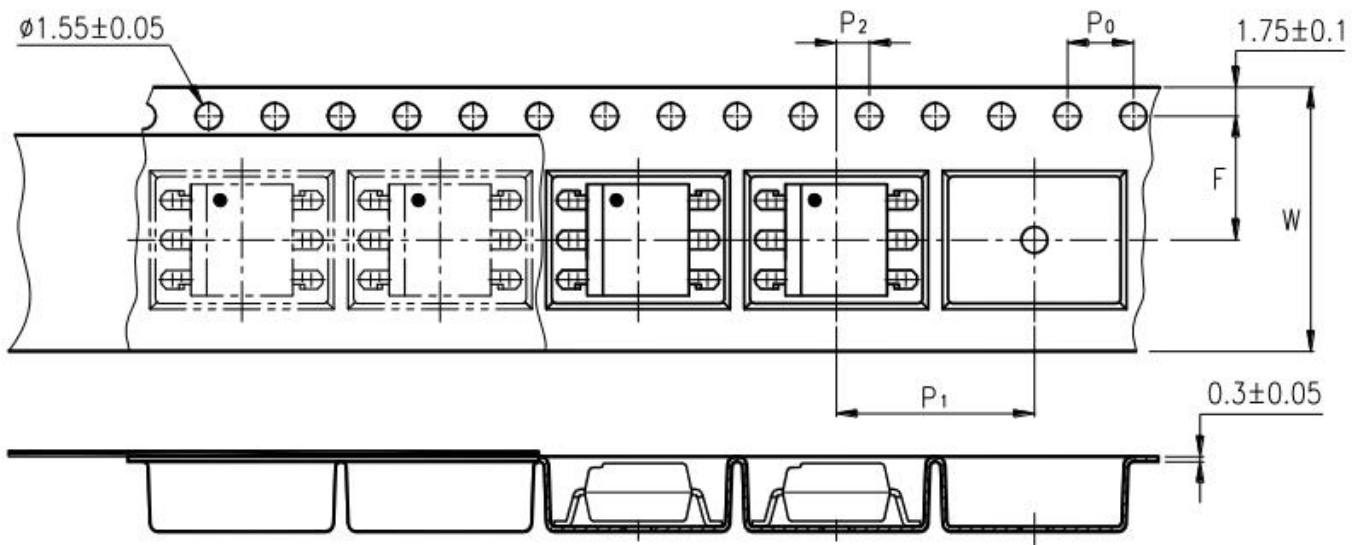

Description	Symbol	Dimension in mm (inch)
Tape wide	W	$16 \pm 0.3$ (0.63)
Pitch of sprocket holes	$P_0$	$4 \pm 0.1$ (0.15)
Distance of compartment	F	$7.5 \pm 0.1$ (0.295)
	$P_2$	$2 \pm 0.1$ (0.079)
Distance of compartment to compartment	$P_1$	$12 \pm 0.1$ (0.472)

Package Type	MOC302XS series (TA/TA1)
Quantities(pcs)	1000

### 9. Temperature Profile Of Soldering

(1).IR Reflow soldering (JEDEC-STD-020C compliant)

One time soldering reflow is recommended within the condition of temperature and time profile shown below. Do not solder more than three times.

Profile item	Conditions
Preheat	
- Temperature Min ( $T_{Smin}$ )	150°C
- Temperature Max ( $T_{Smax}$ )	200°C
- Time (min to max) ( $t_s$ )	90±30 sec
Soldering zone	
- Temperature ( $T_L$ )	217°C
- Time ( $t_L$ )	60 sec
Peak Temperature( $T_P$ )	260°C
Ramp-up rate	3°C / sec max.
Ramp-down rate	3~6°C / sec

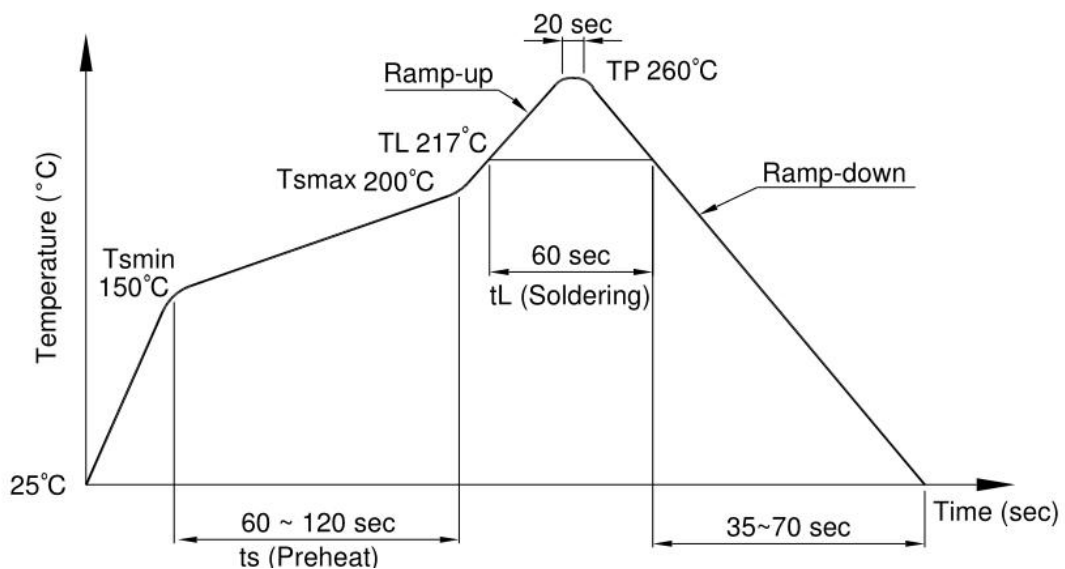



**(2) .Wave soldering (JEDEC22A111 compliant)**

One time soldering is recommended within the condition of temperature.

Temperature	260+0/-5°C
Time	10 sec
Preheat temperature	5 to 140°C
Preheat time	30 to 80 sec

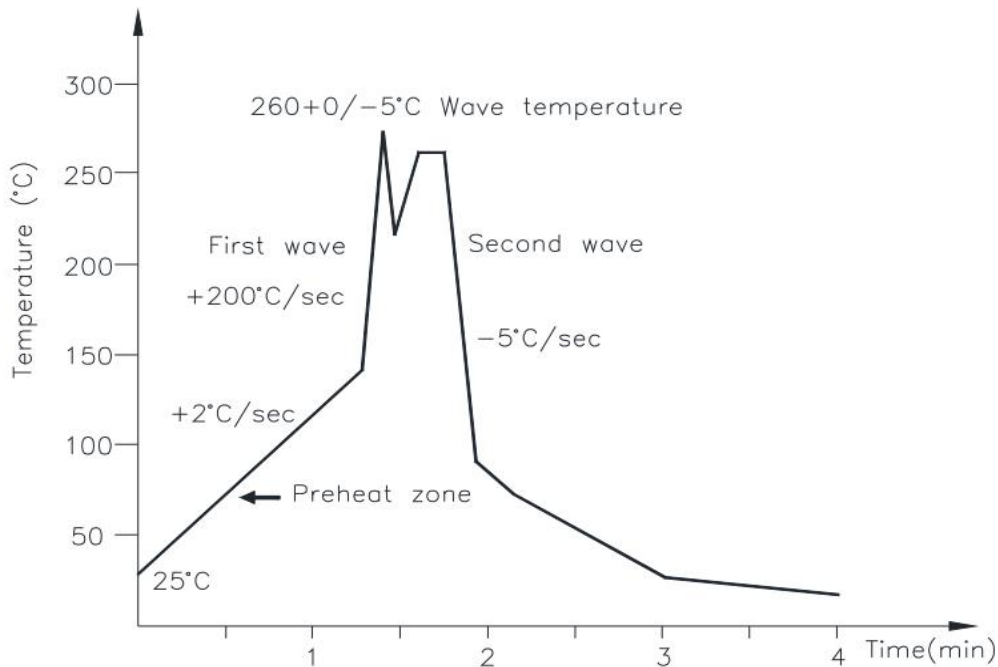

**(3).Hand soldering by soldering iron**

Allow single lead soldering in every single process. One time soldering is recommended.

Temperature	380+0/-5°C
Time	3 sec max

### 10.RRECOMMENDED FOOT PRINT PATTERNS (MOUNT PAD)

Unit: mm

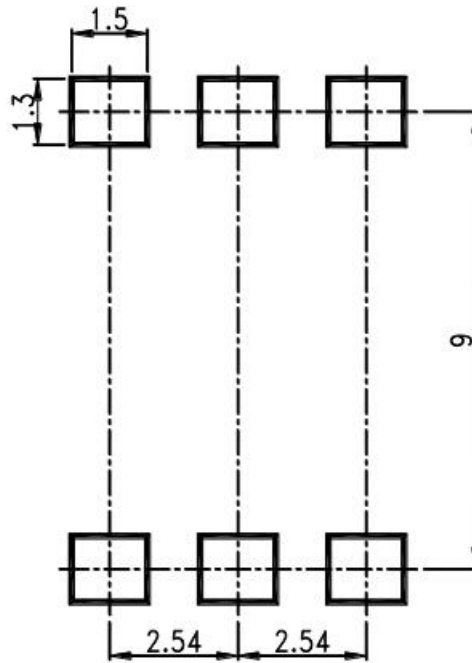

### 11. CHARACTERISTICS CURVES (TYPICAL PERFORMANCE)

Fig.1 Forward Current vs. Ambient Temperature

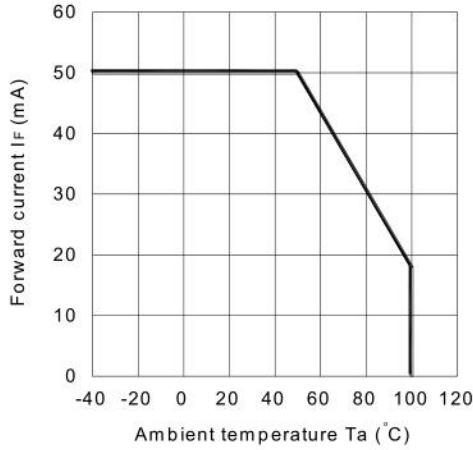

Fig.2 On-state Current vs. Ambient Temperature

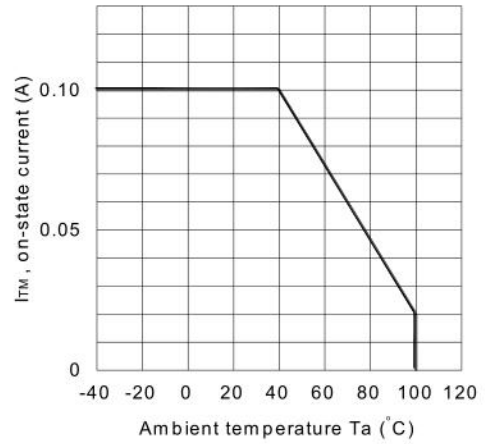

Fig.3 Minimum Trigger Current vs. Ambient Temperature

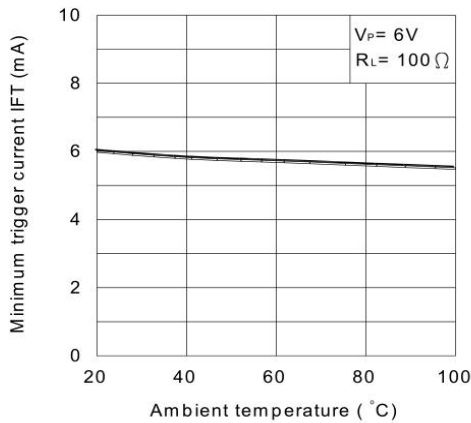

Fig.4 Forward Current vs. Forward Voltage

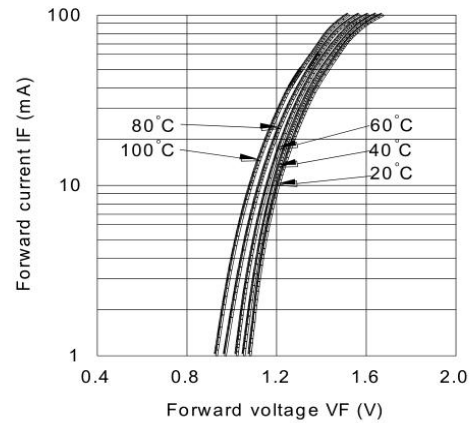

Fig.5 On-state Voltage vs. Ambient Temperature

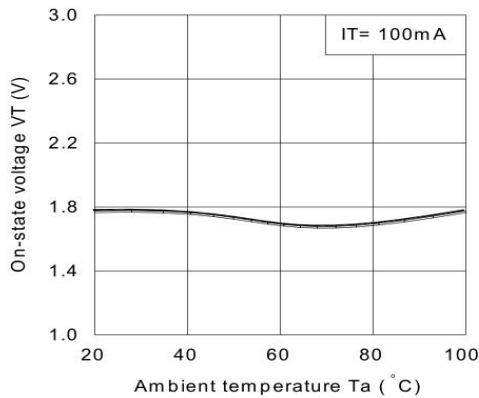

Fig.6 Holding Current vs. Ambient Temperature

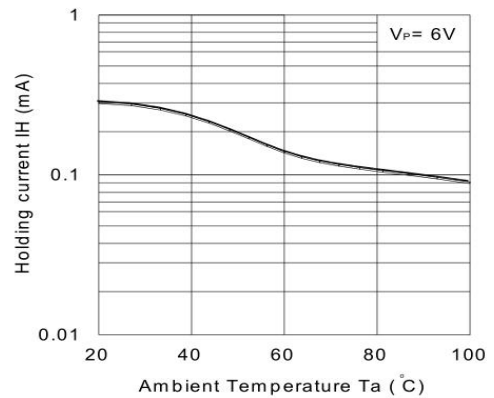

Fig.7 Repetitive Peak Off-state Current vs. Temperature

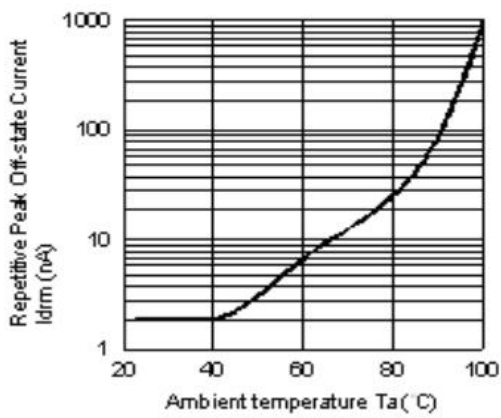
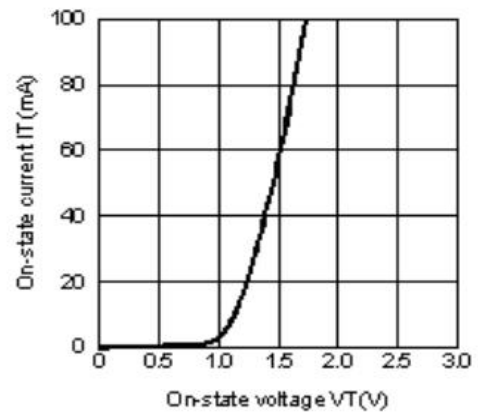

Fig.8 On-state Current vs. On-state Voltage



Basic Operation Circuit  
Medium/High Power Triac Drive Circuit

