

### Features

- 3.2mmx1.6mm SMT LED, 0.75mm THICKNESS.
- LOW POWER CONSUMPTION.
- WIDE VIEWING ANGLE.
- IDEAL FOR BACKLIGHT AND INDICATOR.
- VARIOUS COLORS AND LENS TYPES AVAILABLE.
- PACKAGE : 2000PCS / REEL.
- MOISTURE SENSITIVITY LEVEL : LEVEL 3.
- RoHS COMPLIANT.

### Description

The Super Bright Orange device is made with DH InGaAlP (on GaAs substrate) light emitting diode chip.

### Package Dimensions

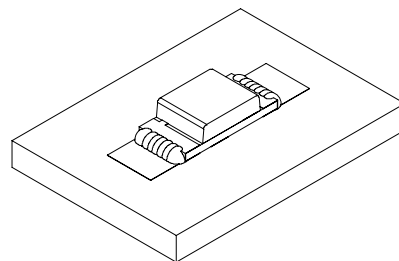
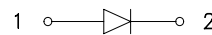
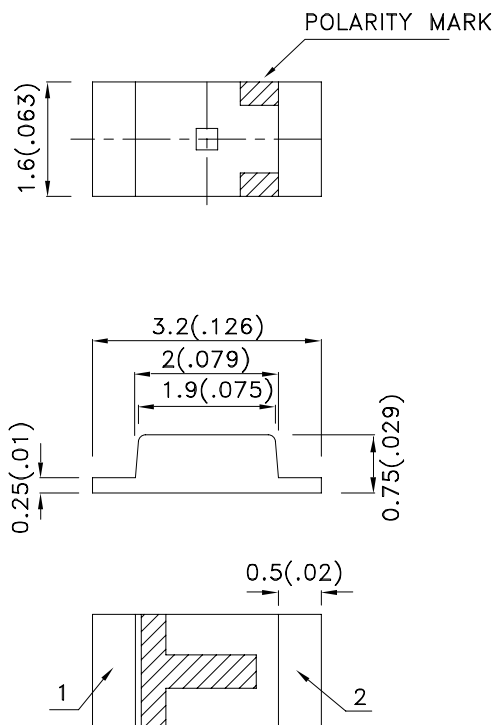

1. All dimensions are in millimeters (inches).
2. Tolerance is  $\pm 0.2(0.008)$  unless otherwise noted.
3. Specifications are subject to change without notice.
4. The device has a single mounting surface. The device must be mounted according to the specifications.



## Selection Guide

| Part No.    | Dice                          | Lens Type   | Iv (mcd) [2]<br>@ 20mA |      | Viewing<br>Angle<br>[1] |
|-------------|-------------------------------|-------------|------------------------|------|-------------------------|
|             |                               |             | Min.                   | Typ. | 2θ1/2                   |
| APT3216SECK | Super Bright Orange (InGaAlP) | WATER CLEAR | 50                     | 160  | 120°                    |

Notes:

1. θ1/2 is the angle from optical centerline where the luminous intensity is 1/2 the optical centerline value.
2. Luminous intensity/ luminous Flux: +/-15%.

## Electrical / Optical Characteristics at TA=25°C

| Symbol                | Parameter                | Device              | Typ. | Max. | Units | Test Conditions           |
|-----------------------|--------------------------|---------------------|------|------|-------|---------------------------|
| $\lambda_{peak}$      | Peak Wavelength          | Super Bright Orange | 610  |      | nm    | I <sub>F</sub> =20mA      |
| $\lambda_D$ [1]       | Dominant Wavelength      | Super Bright Orange | 601  |      | nm    | I <sub>F</sub> =20mA      |
| $\Delta\lambda_{1/2}$ | Spectral Line Half-width | Super Bright Orange | 29   |      | nm    | I <sub>F</sub> =20mA      |
| C                     | Capacitance              | Super Bright Orange | 15   |      | pF    | V <sub>F</sub> =0V;f=1MHz |
| V <sub>F</sub> [2]    | Forward Voltage          | Super Bright Orange | 2.1  | 2.5  | V     | I <sub>F</sub> =20mA      |
| I <sub>R</sub>        | Reverse Current          | Super Bright Orange |      | 10   | uA    | V <sub>R</sub> =5V        |

Notes:

1. Wavelength: +/-1nm.
2. Forward Voltage: +/-0.1V.

## Absolute Maximum Ratings at TA=25°C

| Parameter                | Super Bright Orange | Units |
|--------------------------|---------------------|-------|
| Power dissipation        | 75                  | mW    |
| DC Forward Current       | 30                  | mA    |
| Peak Forward Current [1] | 195                 | mA    |
| Reverse Voltage          | 5                   | V     |
| Operating Temperature    | -40°C To +85°C      |       |
| Storage Temperature      | -40°C To +85°C      |       |

Note:

1. 1/10 Duty Cycle, 0.1ms Pulse Width.

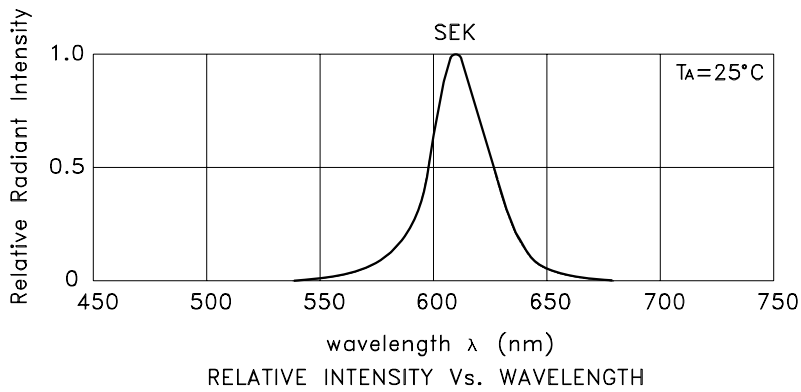

## Super Bright Orange APT3216SECK

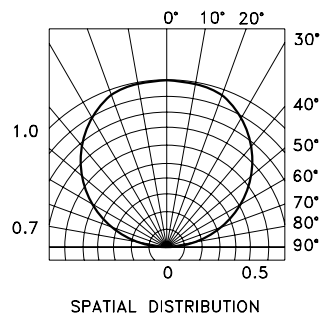
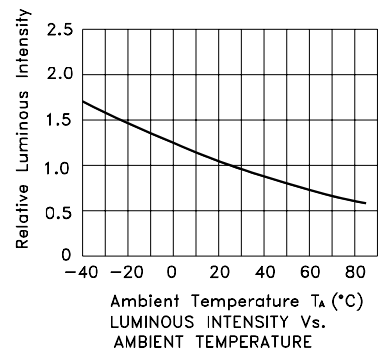
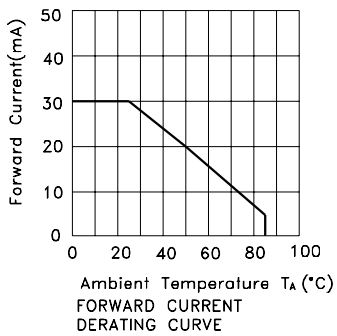
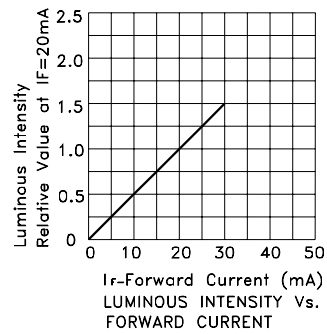
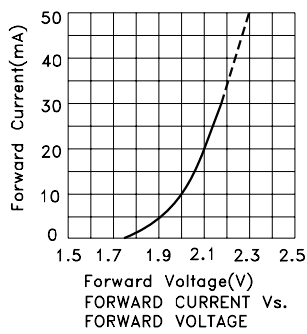

## APT3216SECK

Reflow Soldering Profile For Lead-free SMT Process.



NOTES:

1. We recommend the reflow temperature 245°C(+/-5°C). The maximum soldering temperature should be limited to 260°C.
2. Don't cause stress to the epoxy resin while it is exposed to high temperature.
3. Number of reflow process shall be 2 times or less.

### Recommended Soldering Pattern (Units : mm; Tolerance: ± 0.1)

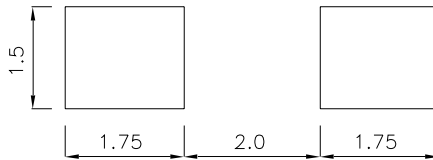

### Tape Specifications (Units : mm)

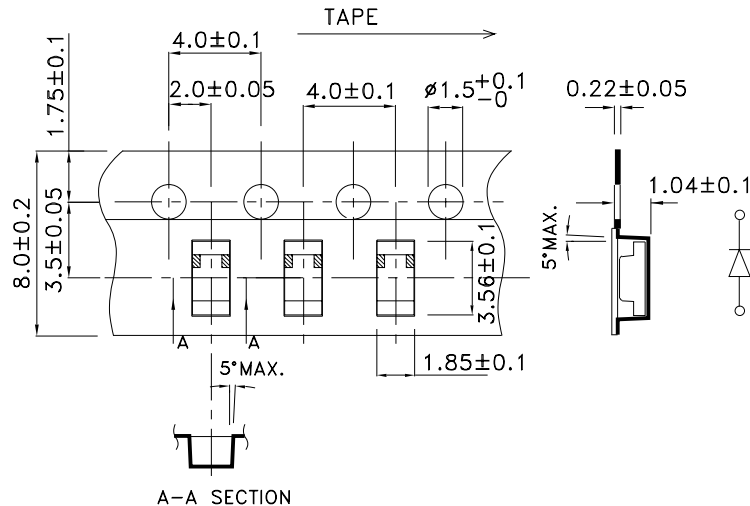

# Kingbright

## PACKING & LABEL SPECIFICATIONS

## APT3216SECK

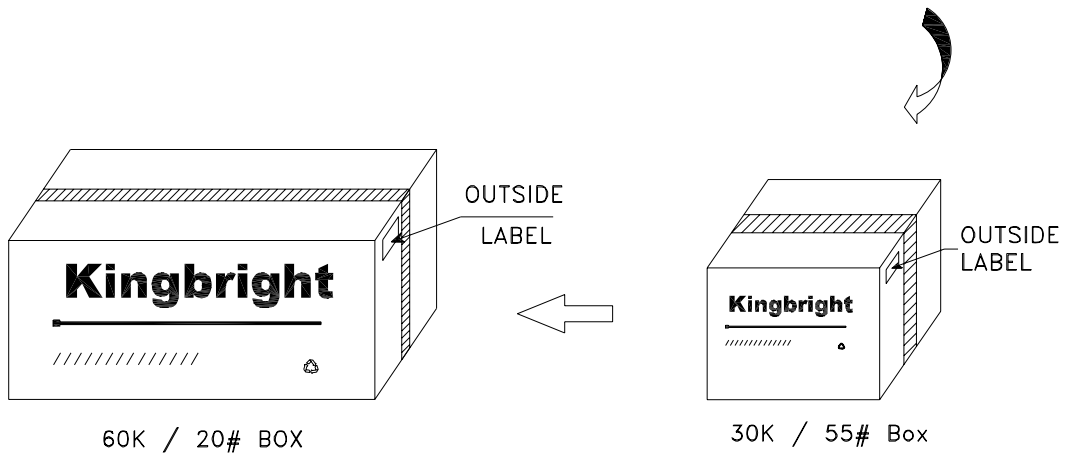
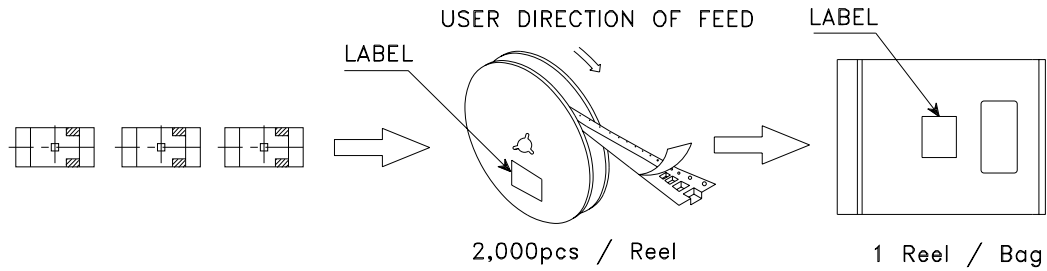

|   |  |
|---|--|
| <h1>Kingbright</h1>   |  |
| P/NO: APT3216xxx  |  |
| QTY: 2,000 pcs  | Q.C. <span style="border: 1px solid black; border-radius: 50%; padding: 2px;">Q C<br/>xx xx xxxx<br/>PASSED</span> |
| S/N: XXXX   |  |
| CODE: XXX   |  |
| LOT NO:   |  |
| <br><small>XXXXXXXXXXXXXXXXXXXXXXXXXXXX</small> |  |
| MADE IN CHINA   | RoHS Compliant   |