

Mechanical Key Switch

B3F

A Wide Range of Models: 6 x 6 mm, 12 x 12 mm, Vertical and High-force.

- Excellent tactile feel combined with high life expectancy.
- Available in stick packaging for automatic mounting to PCBs.
- Up to 2.55 N (260-gf) operating force for a firmer operating touch.
- Pushbuttons available in nine colors.

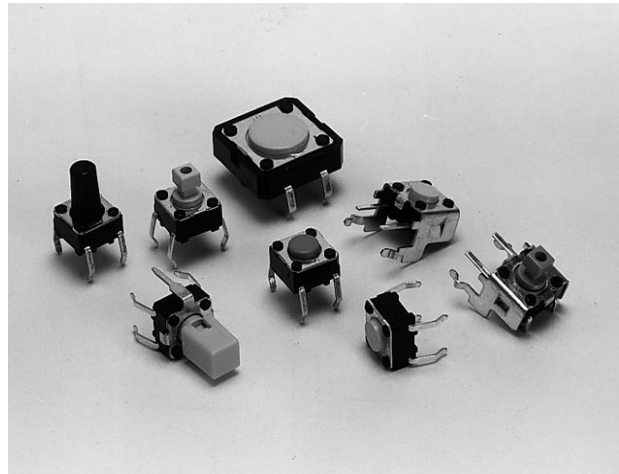

Ordering Information

6 x 6 mm Models

Type	Plunger	Height x pitch	Operating force (OF)	Without ground terminal		With ground terminal		
				Bags *	Sticks (90/stick)	Bags *	Sticks (75/stick)	
Standard (B3F-1□□□)	Flat	4.3 x 6.5 mm	0.98 N (100 gf)	B3F-1000	B3F-1000S	B3F-1100	B3F-1100S	
			1.47 N (150 gf)	B3F-1002	B3F-1002S	B3F-1102	B3F-1102S	
			2.55 N (260 gf)	B3F-1005	B3F-1005S	B3F-1105	B3F-1105S	
		5.0 x 6.5 mm	0.98 N (100 gf)	B3F-1020	B3F-1020S	B3F-1120	B3F-1120S	
			1.47 N (150 gf)	B3F-1022	B3F-1022S	B3F-1122	B3F-1122S	
			2.55 N (260 gf)	B3F-1025	B3F-1025S	B3F-1125	B3F-1125S	
	Projected	7.3 x 6.5 mm	0.98 N (100 gf)	B3F-1050	B3F-1050S	B3F-1150	B3F-1150S	
			1.47 N (150 gf)	B3F-1052	B3F-1052S	B3F-1152	B3F-1152S	
			2.55 N (260 gf)	B3F-1055	B3F-1055S	B3F-1155	B3F-1155S	
	Extended	9.5 x 6.5 mm	0.98 N (100 gf)	B3F-1070	---	---	---	
	Vertical (B3F-3□□□)	Flat	3.15 mm	0.98 N (100 gf)	---	---	B3F-3100	---
				1.47 N (150 gf)	---	---	B3F-3102	---
2.55 N (260 gf)				---	---	B3F-3105	---	
3.85 mm			0.98 N (100 gf)	---	---	B3F-3120	---	
			1.47 N (150 gf)	---	---	B3F-3122	---	
			2.55 N (260 gf)	---	---	B3F-3125	---	
Projected		6.15 mm	0.98 N (100 gf)	---	---	B3F-3150	---	
			1.47 N (150 gf)	---	---	B3F-3152	---	
			2.55 N (260 gf)	---	---	B3F-3155	---	

* (100 / bag)

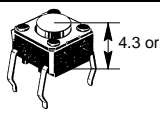
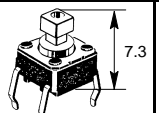
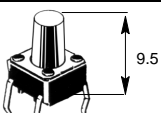
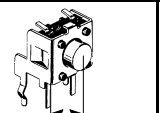
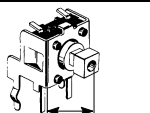
Plunger type	Flat	Projected	Extended	Flat (vertical)	Projected (vertical)
Appearance					

12 x 12 mm Models

Type	Plunger (or LED color)	Height x pitch	Operating force (OF)	Without ground terminal		With ground terminal	
				Bags **	Sticks (45/stick)*	Bags **	Sticks (45/stick)
Standard (B3F-4□□□)	Flat	4.3 x 12.5 mm	1.27 N (130 gf)	B3F-4000	B3F-4000S	B3F-4100	B3F-4100S
			2.55 N (260 gf)	B3F-4005	B3F-4005S	B3F-4105	B3F-4105S
	Projected	7.3 x 12.5 mm	1.27 N (130 gf)	B3F-4050	B3F-4050S	B3F-4150	B3F-4150S
			2.55 N (260 gf)	B3F-4055	B3F-4055S	B3F-4155	B3F-4155S
Long life expectancy (B3F-5□□□0)	Flat	4.3 x 12.5 mm	1.27 N (130 gf)	B3F-5000	B3F-5000S	B3F-5100	B3F-5100S
	Projected	7.3 x 12.5 mm		B3F-5050	B3F-5050S	B3F-5150	B3F-5150S
High reliability gold-plated (B3F-5□□□1)	Flat	4.3 x 12.5 mm	1.27 N (130 gf)	B3F-5001	B3F-5001S	B3F-5101	B3F-5101S
	Projected	7.3 x 12.5 mm		B3F-5051	B3F-5051S	B3F-5151	B3F-5151S
Surface illumination (B3F-9□□□□)	Red LED	7.3 x 12.5 mm	1.27 N (130 gf)	---	B3F-9100	---	---
	Green LED			---	B3F-9200	---	---
	Yellow LED			---	B3F-9300	---	---

* 36 per stick for B3F-9□□□□.

** (100 / bag)

■ Accessories (order separately)

Special keytops are available for projected plunger models. See page 27 (Product B32).

Specifications

■ Ratings

Switching capacity	5 to 24 VDC, 1 to 50 mA (resistive load)
Insulation voltage	30 VDC

■ Characteristics

Contact form	SPST-NO
Contact resistance	100 mΩ max. (at 5 VDC, 1 mA; initial value.)
Insulation resistance	100 MΩ min. (at 250 VDC)
Dielectric strength	500 VAC, 50/60 Hz for 1 min
Bounce time	5 ms max.
Vibration resistance	Malfunction: 10 to 55 Hz, 1.5 mm double amplitude
Shock resistance	Destruction: 1,000 m/s ² min. (Approx. 100 G min.) Malfunction: 100 m/s ² min. (Approx. 10G min.)
Life expectancy	B3F-1□□□, -3□□□: 100-gf OF: 1,000,000 operations min. 150-gf OF: 300,000 operations min. 260-gf OF: 100,000 operations min. B3F-4□□□: 130-gf OF: 3,000,000 operations min. 260-gf OF: 1,000,000 operations min. B3F-5□□□: 10,000,000 operations min. B3F-9□□□: 1,000,000 operations min.
Ambient temperature	-25°C to 70°C (with no icing)
Ambient humidity	35% to 85%
Weight	6 x 6 mm models: approx. 0.25 g 12 x 12 mm models: approx. 0.85 g

■ Operating Characteristics

Model	B3F-1□□□, -3□□□			B3F-4□□□, -5□□□, -9□□□	
	100 gf models	150 gf models	260 gf models	130 gf models	260 gf models
	B3F-1□□□0, -3□□□0	B3F-1□□□2, -3□□□2	B3F-1□□□5, -3□□□5	B3F-4□□□0, -5□□□0, -9□□□0	B3F-4□□□5
Operating force (OF)	0.98±0.32 N (100±30 gf)	1.47±0.49 N (150±50 gf)	2.55±0.69 N (260±70 gf)	1.27±0.49 N (130±50 gf)	2.55±0.69 N (260±70 gf)
Reset force (RF min.)	0.2 N (20 gf)	0.49 N (50 gf)	0.49 N (50 gf)	0.29 N (30 gf)	0.49 N (50 gf)
Pretravel (PT)	0.25 ^{+0.2} / _{-0.1} mm			0.3 ^{+0.2} / _{-0.1} mm	

Engineering Data

Operating Force vs. Stroke (Typical)

B3F-1□□□, -3□□□

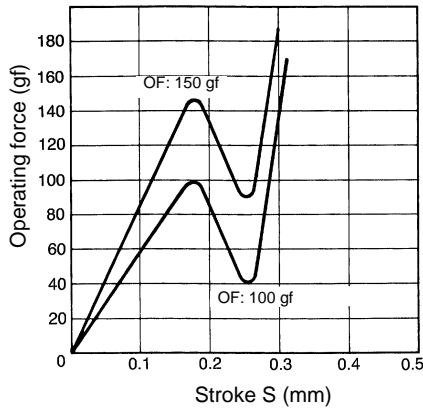

B3F-4□□□, -5□□□, -9□□□

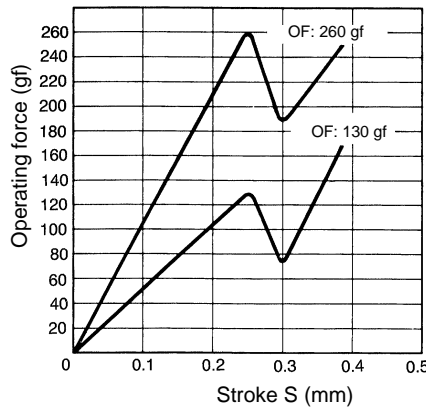

Forward Current Derating Curve

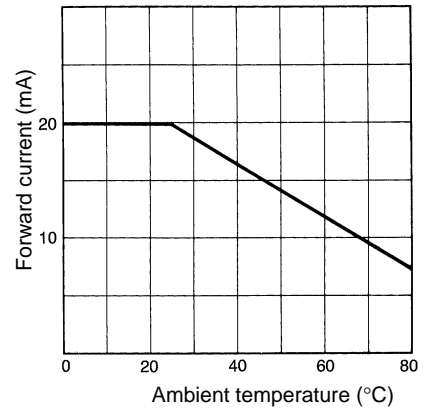

Note: To determine illuminated current of surface illumination types (B3F-9□□□), refer to the above forward current derating curve.

Dimensions

Note: 1. Unless otherwise stated, a tolerance of $\pm 0.4\text{mm}$ applies to all dimensions
2. No terminal numbers appear on the switches. To orient a switch in the "bottom view" position, turn it so that the terminals are on the up and down sides and the word OMRON is right-side up.



6 x 6 mm Models

Standard, Flat Plunger Type (without Ground Terminal)

B3F-1000, -1002, -1005, -1020**, -1022**, -1025**

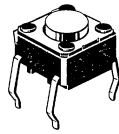
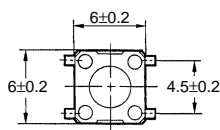

PCB Mounting (Top View)

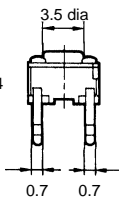
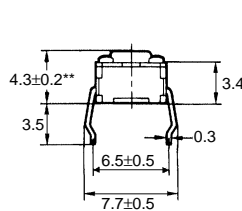
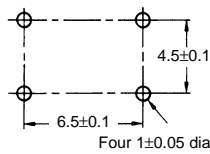

Terminal Arrangement/Internal Connections (Top View)

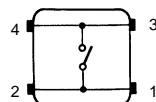

**Height of B3F-1020, -1022, -1025 is $5\pm 0.2\text{ mm}$.

Standard, Flat Plunger Type (with Ground Terminal, Pitch: 6.5 mm)

B3F-1100, -1102, -1105, -1120**, -1122**, -1125**

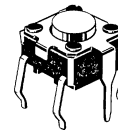
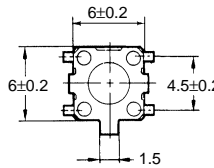

PCB Mounting (Top View)

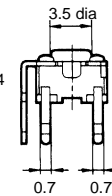
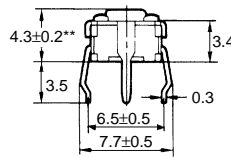
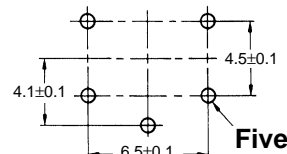

Terminal Arrangement/Internal Connections (Top View)

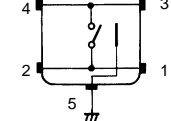

**Height of B3F-1120, -1122, -1125 is $5\pm 0.2\text{ mm}$.

Standard, Projected Plunger Type (without Ground Terminal)

B3F-1050, -1052, -1055

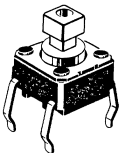
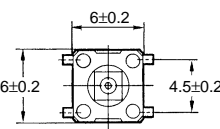

PCB Mounting (Top View)

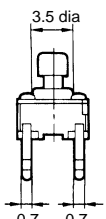
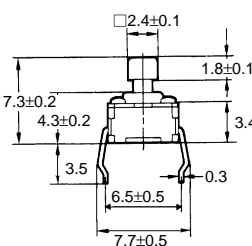
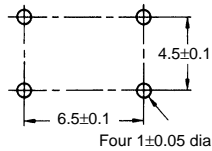

Terminal Arrangement/Internal Connections (Top View)

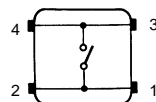

Standard, Projected Plunger Type (with Ground Terminal)

B3F-1150, -1152, -1155

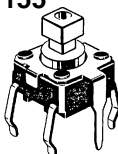
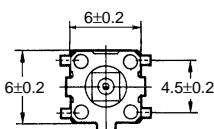

PCB Mounting (Top View)

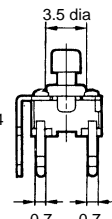
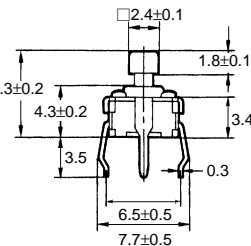
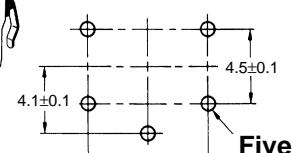

Terminal Arrangement/Internal Connections (Top View)

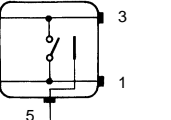

**Extended Type
B3F-1070**

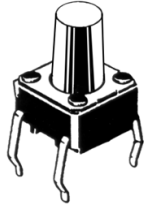
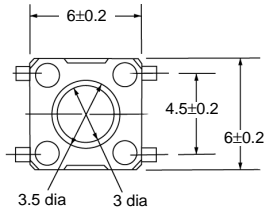

**PCB Mounting
(Top View)**

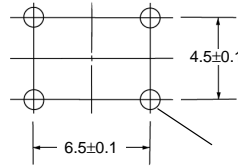

**four 1.0
dia ± 0.05**

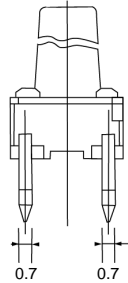
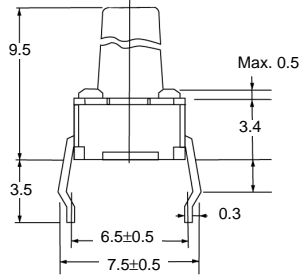

**Internal Connections
(Top View)**

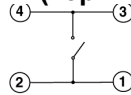

**Vertical, Flat Plunger Type
(Height: 3.15 mm) B3F-3100, -3102, -3105**
(Height: 3.85 mm) B3F-3120, -3122, -3125

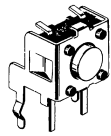
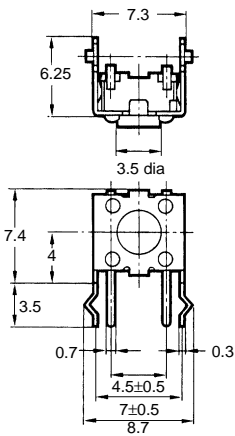

**PCB Mounting
(Top View)**

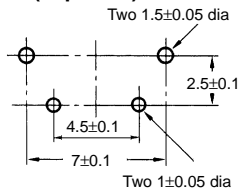

**Terminal Arrangement
/Internal Connections
(Top View)**

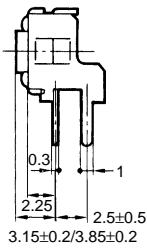
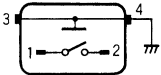

**Vertical, Projected Plunger Type
(Height: 6.15 mm) B3F-3150, -3152, -3155**

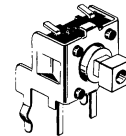
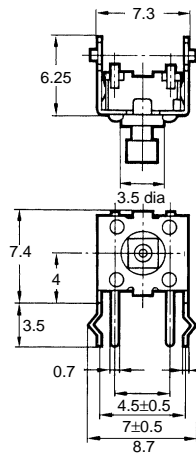

**PCB Mounting
(Top View)**

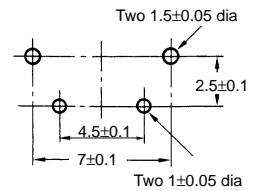

**Terminal Arrangement
/Internal Connections
(Top View)**

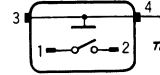

**12 x 12 mm Models
Standard, Long Life Expectancy,
High Reliability, Flat Plunger Type
(without Ground Terminal)
B3F-4000, -4005, -5000, -5001**

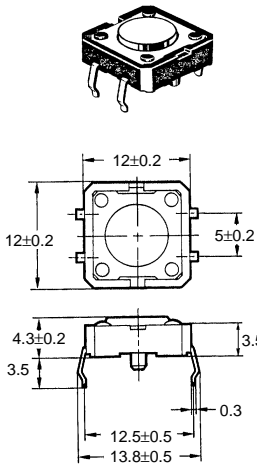

**PCB Mounting
(Top View)**

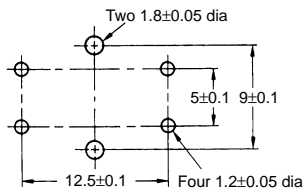

**Terminal Arrangement
/Internal Connections
(Top View)**

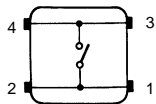

**Standard, Long Life Expectancy,
High Reliability, Flat Plunger Type
(with Ground Terminal)
B3F-4100, -4105, -5100, -5101**

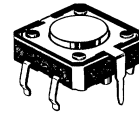
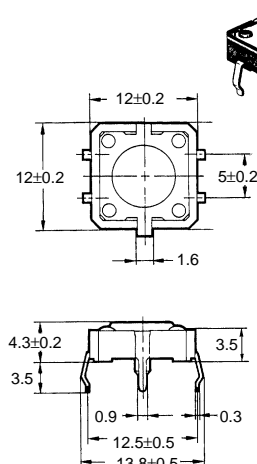

**PCB Mounting
(Top View)**

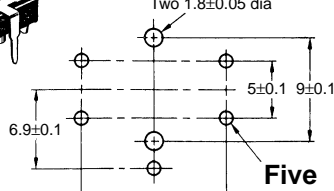

**Terminal Arrangement
/Internal Connections
(Top View)**

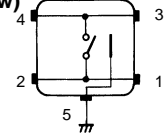

**Standard, Long Life Expectancy,
High Reliability, Projected Plunger
Type (without Ground Terminal)
B3F-4050, -4055, -5050, -5051**

**Standard, Long Life Expectancy,
High Reliability, Projected Plunger
Type (with Ground Terminal)
B3F-4150, -4155, -5150, -5151**

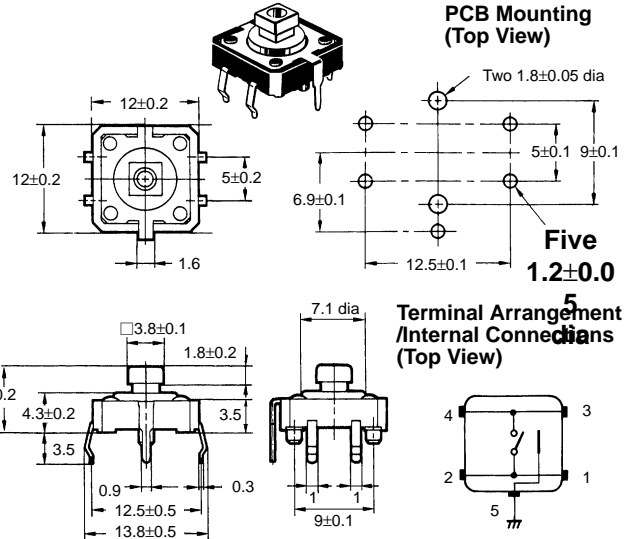
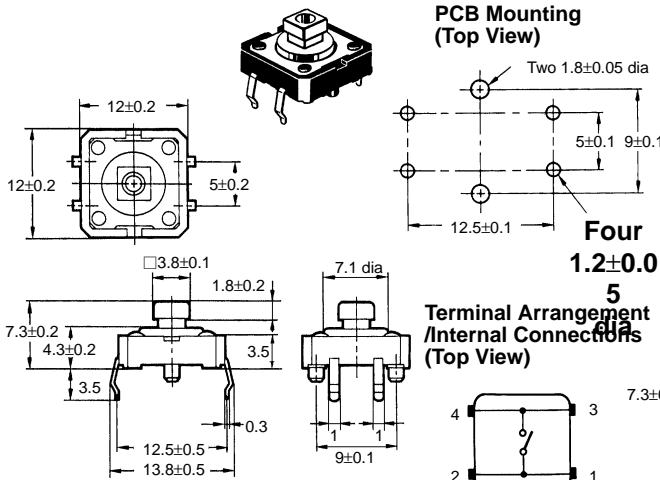

**Surface Illumination Type
B3F-9100, -9200, -9300**

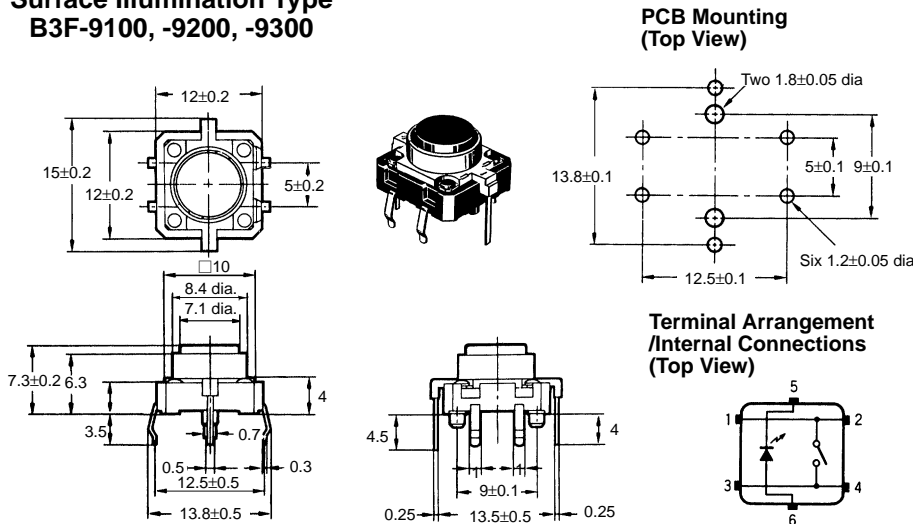

Precautions

- Do not apply additional force to the plunger once it has stopped moving.
- Solder at 260°±5°C within five seconds and within two tries.
- Do not wash the switches. The switches may be damaged by solvents if either wiped off using solvents or immersed in solvents.
- Do not allow flux or flux foam to penetrate onto the component side of the PCB.
- Use a single-sided PCB with a thickness of 1.6 mm. The switches may be damaged due to instability or heat from soldering if other PCBs (other thickness or through holes) are used. If it is necessary to use another PCB, test the compatibility and processing in advance.
- The switches are not sealed and should be protected with a resin sheet as shown below when used in dust-prone environments.

