

PRTR5V0U2X

Ultra low capacitance double rail-to-rail ESD protection diode

Rev. 02 — 14 January 2008

Product data sheet

1. Product profile

1.1 General description

Ultra low capacitance rail-to-rail ElectroStatic Discharge (ESD) protection diode in a small SOT143B Surface-Mounted Device (SMD) plastic package designed to protect two Hi-Speed data lines or high-frequency signal lines from the damage caused by ESD and other transients.

PRTR5V0U2X incorporates two pairs of ultra low capacitance rail-to-rail diodes as well as an additional ESD protection diode to ensure signal line protection even if no supply voltage is available.

1.2 Features

- ESD protection of two Hi-Speed data lines or high-frequency signal lines
- Ultra low input/output to ground capacitance: $C_{(I/O-GND)} = 1 \text{ pF}$
- ESD protection up to 8 kV
- IEC 61000-4-2, level 4 (ESD)
- Very low clamping voltage due to an integrated additional ESD protection diode
- Very low reverse current
- Small SMD plastic package

1.3 Applications

- USB 2.0 ports
- Digital Video Interface (DVI) / High Definition Multimedia Interface (HDMI) interfaces
- Mobile and cordless phones
- Personal Digital Assistants (PDA)
- Digital cameras
- Wide Area Network (WAN) / Local Area Network (LAN) systems
- PCs, notebooks, printers and other PC peripherals

1.4 Quick reference data

Table 1. Quick reference data
T_{amb} = 25 °C unless otherwise specified.

Symbol	Parameter	Conditions	Min	Typ	Max	Unit
Per diode						
V _{RWM}	reverse standoff voltage		-	-	5.5	V
C _(I/O-GND)	input/output to ground capacitance	f = 1 MHz; V _(I/O-GND) = 0 V	[1]	1	1.5	pF
C _{sup}	supply pin to ground capacitance	f = 1 MHz; V _{CC} = 0 V	[2]	16	-	pF

- [1] Measured from pin 2 and 3 to ground.
- [2] Measured from pin 4 to ground.

2. Pinning information

Table 2. Pinning

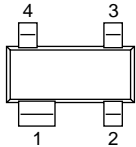
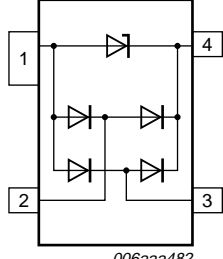
Pin	Symbol	Description	Simplified outline	Graphic symbol
1	GND	ground		 <p style="text-align: right; font-size: small;">006aaa482</p>
2	I/O 1	input/output 1		
3	I/O 2	input/output 2		
4	V _{CC}	supply voltage		

3. Ordering information

Table 3. Ordering information

Type number	Package		Version
	Name	Description	
PRTR5V0U2X	-	plastic surface-mounted package; 4 leads	SOT143B

4. Marking

Table 4. Marking codes

Type number	Marking code ^[1]
PRTR5V0U2X	*R1

- [1] * = -: made in Hong Kong
- * = p: made in Hong Kong
- * = t: made in Malaysia
- * = W: made in China

5. Limiting values

Table 5. Limiting values

In accordance with the Absolute Maximum Rating System (IEC 60134).

Symbol	Parameter	Conditions	Min	Max	Unit
Per device					
T _{amb}	ambient temperature		-40	+85	°C
T _{stg}	storage temperature		-55	+125	°C

Table 6. ESD standards compliance

Standard	Conditions
Per diode	
IEC 61000-4-2; level 4 (ESD)	> 8 kV (contact)

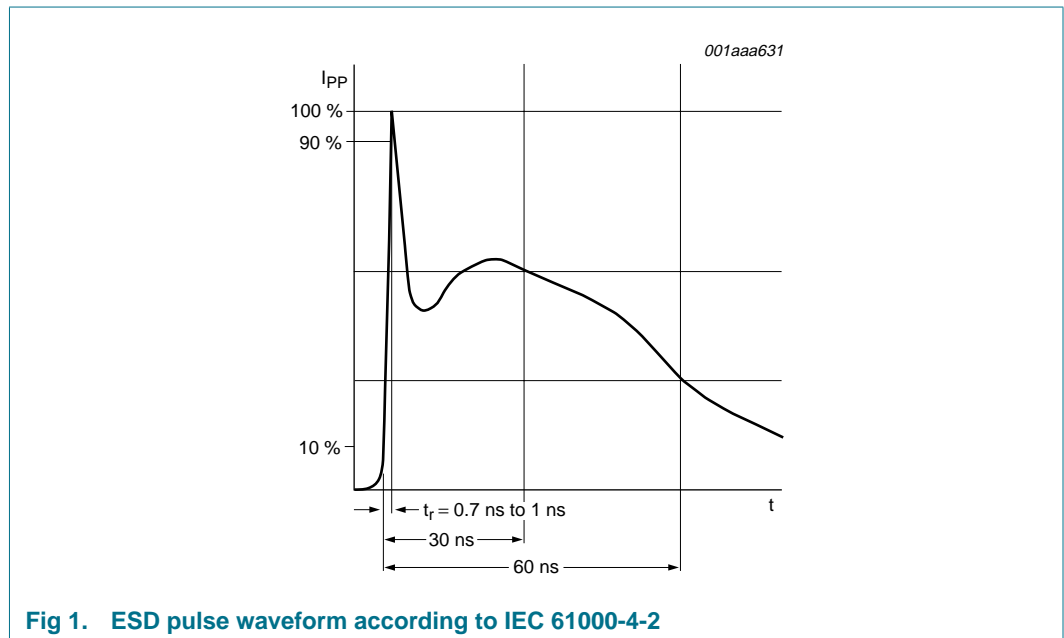

Fig 1. ESD pulse waveform according to IEC 61000-4-2

6. Characteristics

Table 7. Characteristics

$T_{amb} = 25\text{ }^{\circ}\text{C}$ unless otherwise specified.

Symbol	Parameter	Conditions	Min	Typ	Max	Unit	
Per diode							
V_{RWM}	reverse standoff voltage		-	-	5.5	V	
I_R	reverse current	$V_R = 3\text{ V}$	[1]	< 1	100	nA	
V_{BR}	breakdown voltage		[2]	6	9	V	
$C_{(I/O-GND)}$	input/output to ground capacitance	$f = 1\text{ MHz};$ $V_{(I/O-GND)} = 0\text{ V}$	[3]	-	1	1.5	pF
$C_{(I/O-I/O)}$	input/output to input/output capacitance	$f = 1\text{ MHz};$ $V_{(I/O-I/O)} = 0\text{ V}$	[4]	-	0.6	-	pF
C_{sup}	supply pin to ground capacitance	$f = 1\text{ MHz};$ $V_{CC} = 0\text{ V}$	[2]	-	16	-	pF
V_F	forward voltage		-	0.7	-	V	

[1] Measured from pin 2, 3 and 4 to ground.

[2] Measured from pin 4 to ground.

[3] Measured from pin 2 and 3 to ground.

[4] Measured from pin 2 to pin 3.

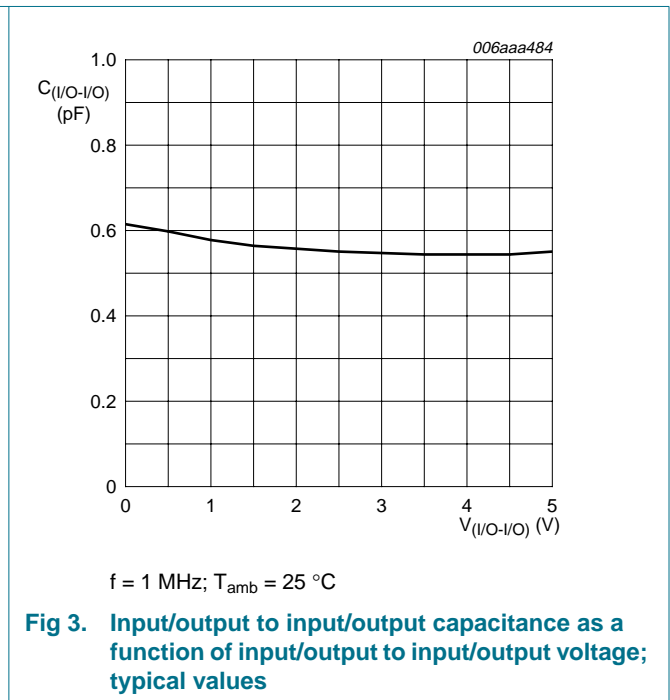
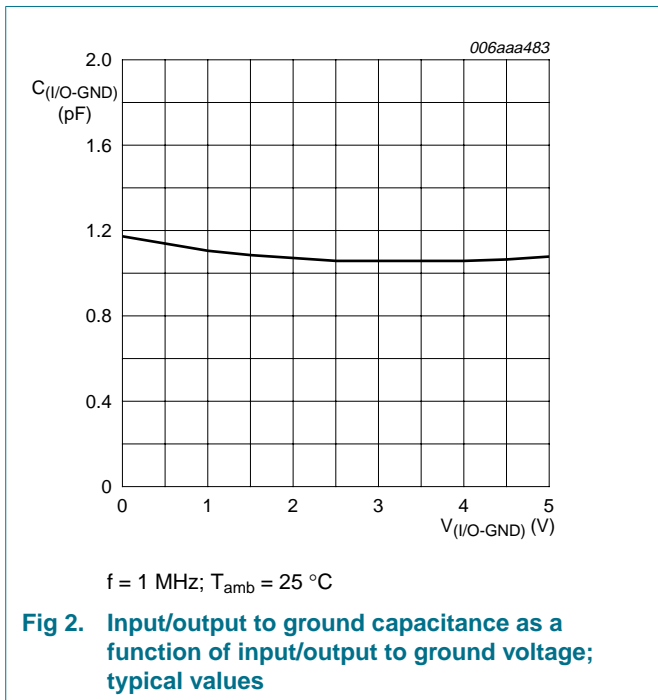

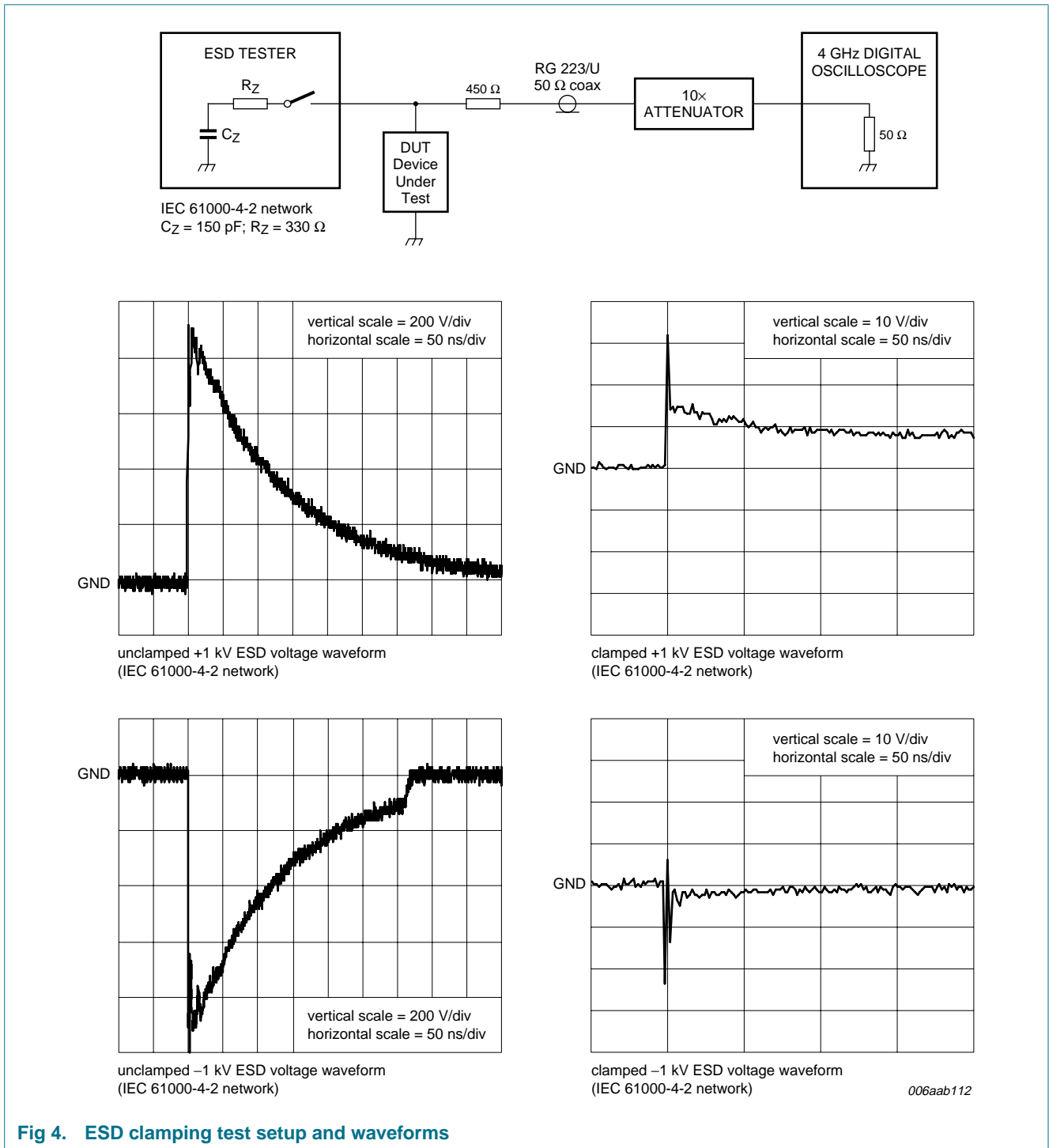

Fig 4. ESD clamping test setup and waveforms

7. Application information

Handling data rates up to 480 Mbit/s, USB 2.0 interfaces require ESD protection devices with an extremely low line capacitance in order to avoid signal distortion.

With a capacitance of only 1 pF, the PRTR5V0U2X offers IEC 61000-4-2, level 4 compliant ESD protection.

The PRTR5V0U2X integrates two pairs of ultra low capacitance rail-to-rail ESD protection diodes and an additional ESD protection diode.

The additional ESD protection diode connected between ground and V_{CC} prevents charging of the supply.

To achieve the maximum ESD protection level, no additional external capacitors are required.

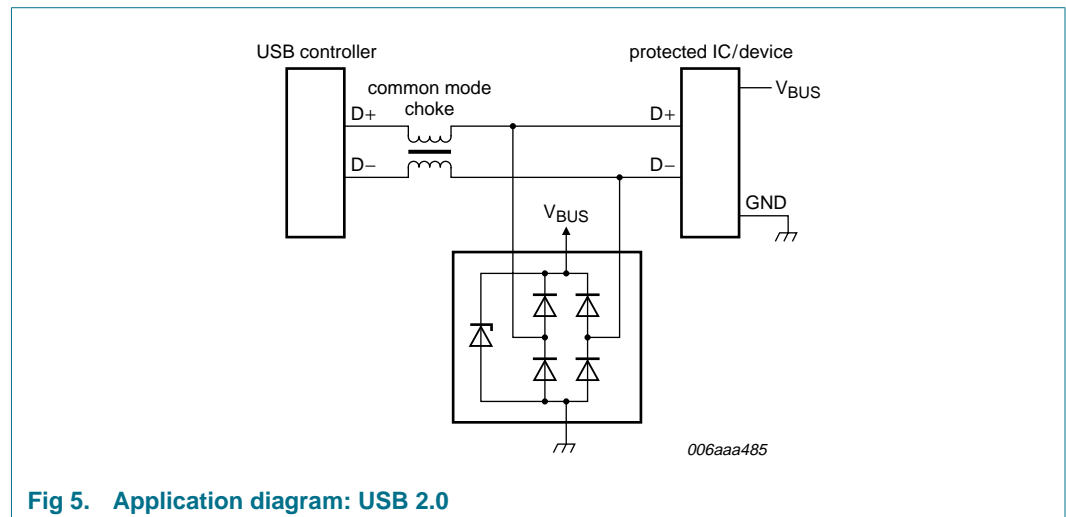

Fig 5. Application diagram: USB 2.0

Circuit board layout and protection device placement

Circuit board layout is critical for the suppression of ESD, Electrical Fast Transient (EFT) and surge transients. The following guidelines are recommended:

1. Place the PRTR5V0U2X as close to the input terminal or connector as possible.
2. The path length between the PRTR5V0U2X and the protected line should be minimized.
3. Keep parallel signal paths to a minimum.
4. Avoid running protected conductors in parallel with unprotected conductors.
5. Minimize all Printed-Circuit Board (PCB) conductive loops including power and ground loops.
6. Minimize the length of the transient return path to ground.
7. Avoid using shared transient return paths to a common ground point.
8. Ground planes should be used whenever possible. For multilayer PCBs, use ground vias.

8. Package outline

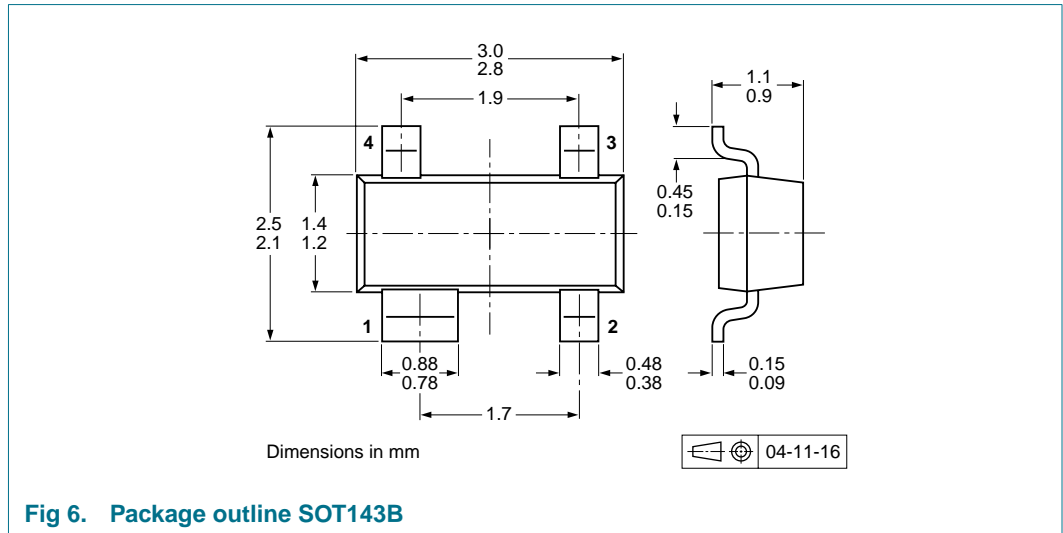

Fig 6. Package outline SOT143B

9. Packing information

Table 8. Packing methods

The indicated -xxx are the last three digits of the 12NC ordering code.^[1]

Type number	Package	Description	Packing quantity	
			3000	10000
PRTR5V0U2X	SOT143B	4 mm pitch, 8 mm tape and reel	-215	-235

[1] For further information and the availability of packing methods, see [Section 13](#).

10. Soldering

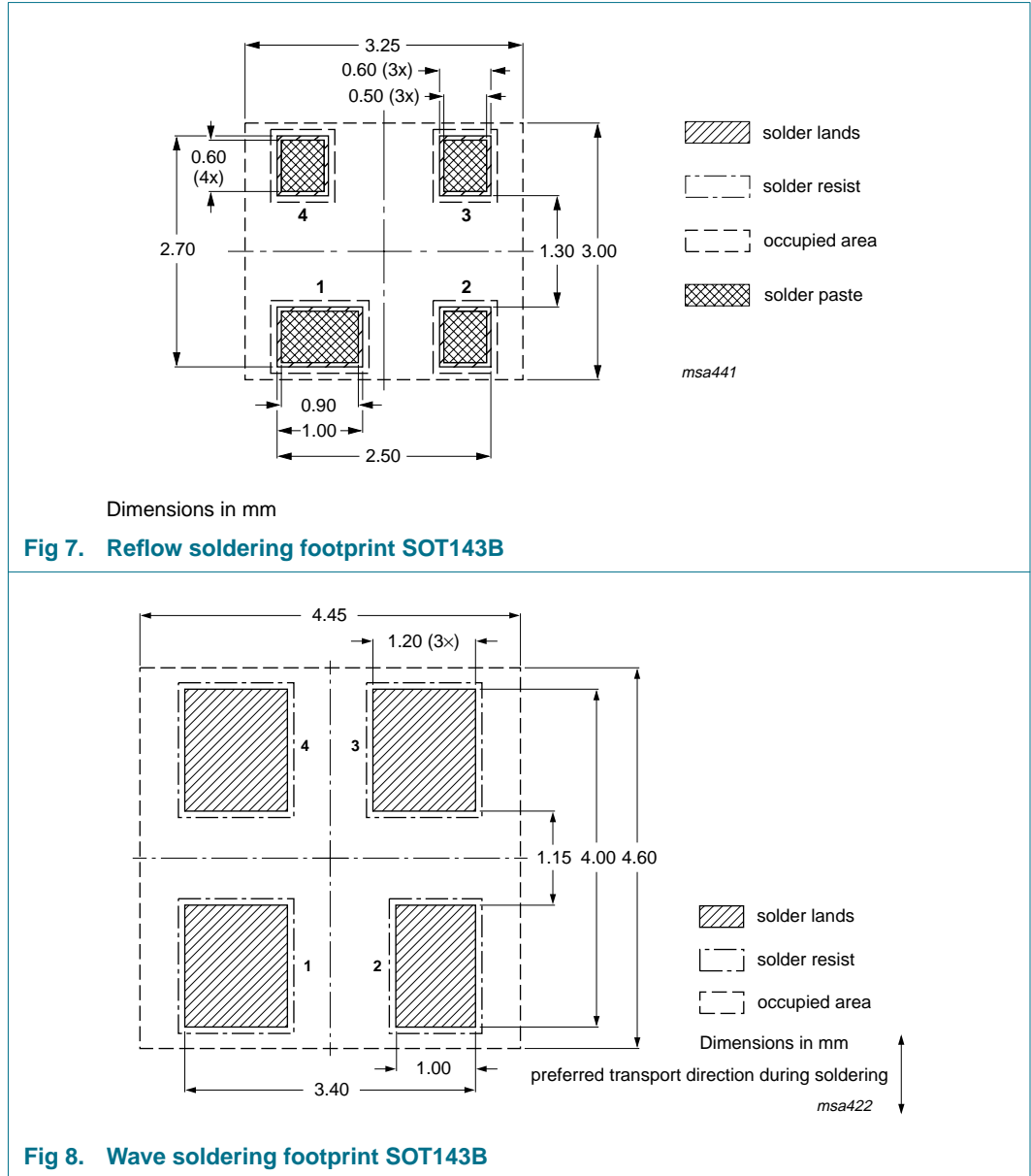

11. Revision history

Table 9. Revision history

Document ID	Release date	Data sheet status	Change notice	Supersedes
PRTR5V0U2X_2	20080114	Product data sheet	-	PRTR5V0U2X_1
Modifications:		<ul style="list-style-type: none"> The format of this data sheet has been redesigned to comply with the new identity guidelines of NXP Semiconductors. Legal texts have been adapted to the new company name where appropriate. Table 1: parameter for $C_{(I/O-GND)}$ redefined to input/output to ground capacitance Table 1 "Quick reference data": maximum value for $C_{(I/O-GND)}$ added Table 7: parameter for $C_{(I/O-GND)}$ redefined to input/output to ground capacitance Table 7 "Characteristics": maximum value for $C_{(I/O-GND)}$ added Table 7: parameter for $C_{(I/O-I/O)}$ redefined to input/output to input/output capacitance Table 7: parameter for C_{sup} redefined to supply pin to ground capacitance Section 10 "Soldering": added Section 12 "Legal information": updated 		
PRTR5V0U2X_1	20050922	Product data sheet	-	-

12. Legal information

12.1 Data sheet status

Document status ^{[1][2]}	Product status ^[3]	Definition
Objective [short] data sheet	Development	This document contains data from the objective specification for product development.
Preliminary [short] data sheet	Qualification	This document contains data from the preliminary specification.
Product [short] data sheet	Production	This document contains the product specification.

[1] Please consult the most recently issued document before initiating or completing a design.

[2] The term 'short data sheet' is explained in section "Definitions".

[3] The product status of device(s) described in this document may have changed since this document was published and may differ in case of multiple devices. The latest product status information is available on the Internet at URL <http://www.nxp.com>.

12.2 Definitions

Draft — The document is a draft version only. The content is still under internal review and subject to formal approval, which may result in modifications or additions. NXP Semiconductors does not give any representations or warranties as to the accuracy or completeness of information included herein and shall have no liability for the consequences of use of such information.

Short data sheet — A short data sheet is an extract from a full data sheet with the same product type number(s) and title. A short data sheet is intended for quick reference only and should not be relied upon to contain detailed and full information. For detailed and full information see the relevant full data sheet, which is available on request via the local NXP Semiconductors sales office. In case of any inconsistency or conflict with the short data sheet, the full data sheet shall prevail.

12.3 Disclaimers

General — Information in this document is believed to be accurate and reliable. However, NXP Semiconductors does not give any representations or warranties, expressed or implied, as to the accuracy or completeness of such information and shall have no liability for the consequences of use of such information.

Right to make changes — NXP Semiconductors reserves the right to make changes to information published in this document, including without limitation specifications and product descriptions, at any time and without notice. This document supersedes and replaces all information supplied prior to the publication hereof.

Suitability for use — NXP Semiconductors products are not designed, authorized or warranted to be suitable for use in medical, military, aircraft, space or life support equipment, nor in applications where failure or

malfunction of an NXP Semiconductors product can reasonably be expected to result in personal injury, death or severe property or environmental damage. NXP Semiconductors accepts no liability for inclusion and/or use of NXP Semiconductors products in such equipment or applications and therefore such inclusion and/or use is at the customer's own risk.

Applications — Applications that are described herein for any of these products are for illustrative purposes only. NXP Semiconductors makes no representation or warranty that such applications will be suitable for the specified use without further testing or modification.

Limiting values — Stress above one or more limiting values (as defined in the Absolute Maximum Ratings System of IEC 60134) may cause permanent damage to the device. Limiting values are stress ratings only and operation of the device at these or any other conditions above those given in the Characteristics sections of this document is not implied. Exposure to limiting values for extended periods may affect device reliability.

Terms and conditions of sale — NXP Semiconductors products are sold subject to the general terms and conditions of commercial sale, as published at <http://www.nxp.com/profile/terms>, including those pertaining to warranty, intellectual property rights infringement and limitation of liability, unless explicitly otherwise agreed to in writing by NXP Semiconductors. In case of any inconsistency or conflict between information in this document and such terms and conditions, the latter will prevail.

No offer to sell or license — Nothing in this document may be interpreted or construed as an offer to sell products that is open for acceptance or the grant, conveyance or implication of any license under any copyrights, patents or other industrial or intellectual property rights.

12.4 Trademarks

Notice: All referenced brands, product names, service names and trademarks are the property of their respective owners.

13. Contact information

For additional information, please visit: <http://www.nxp.com>

For sales office addresses, send an email to: salesaddresses@nxp.com

14. Contents

1	Product profile	1
1.1	General description	1
1.2	Features	1
1.3	Applications	1
1.4	Quick reference data	2
2	Pinning information	2
3	Ordering information	2
4	Marking	2
5	Limiting values	3
6	Characteristics	4
7	Application information	6
8	Package outline	7
9	Packing information	7
10	Soldering	8
11	Revision history	9
12	Legal information	10
12.1	Data sheet status	10
12.2	Definitions	10
12.3	Disclaimers	10
12.4	Trademarks	10
13	Contact information	10
14	Contents	11

Please be aware that important notices concerning this document and the product(s) described herein, have been included in section 'Legal information'.



© NXP B.V. 2008.

All rights reserved.

For more information, please visit: <http://www.nxp.com>

For sales office addresses, please send an email to: salesaddresses@nxp.com

Date of release: 14 January 2008

Document identifier: PRTR5V0U2X_2