

THIS DRAWING IS UNPUBLISHED. RELEASED FOR PUBLICATION 20
 © COPYRIGHT 20 BY - ALL RIGHTS RESERVED.

LOC		DIST		REVISIONS			
P	LTR	DESCRIPTION	DATE	DWN	APVD		
CG	00	B2	REVISD PER ECO-11-005027	14MAR2011	RK	HMR	

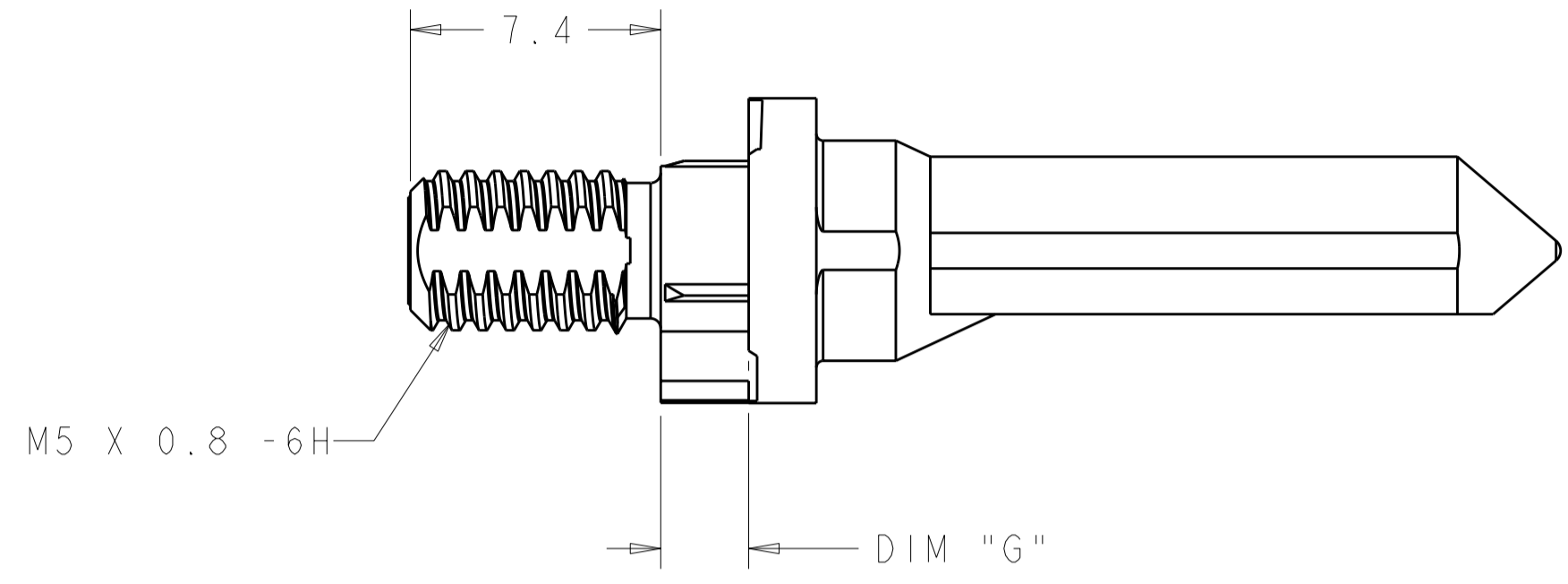

- 1 MATERIAL: ZINC ALLOY
- 2 OBSOLETE PART NUMBER
- 3 KEY HOLE ORIENTATION (DIM A) PER MATING GUIDE MODULE PART NUMBER TABLE (ORIENTATION SHOWN ON PCB LAYOUT IS FOR 1469492-2)
- 4 ANNULAR RING PLATED AROUND GUIDE PIN MOUNTING HOLE ON TOP AND BOTTOM SIDE OF BOARD
- 5 FINISH:
3.81µm MINIMUM SILVER IN CONTACT AREA
OVER NICKEL OVER COPPER ALL OVER

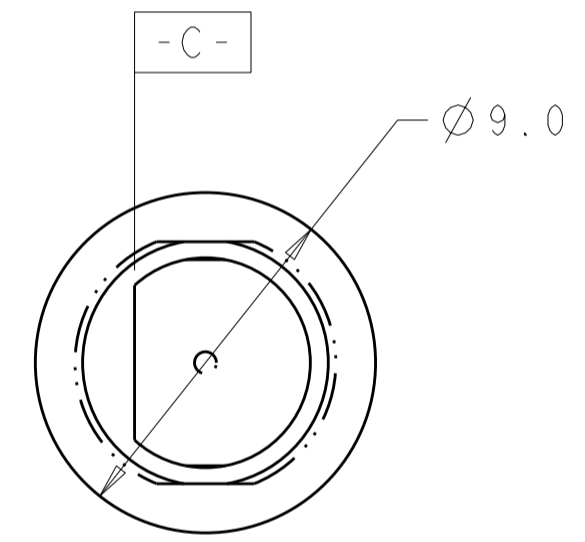
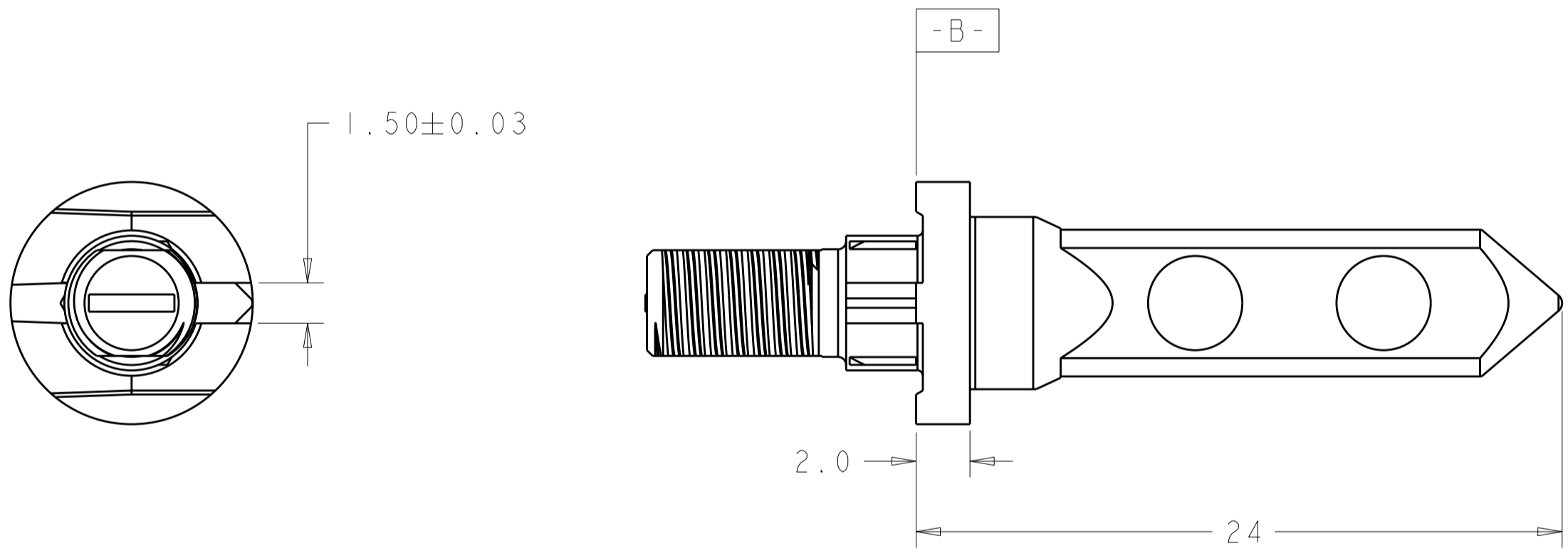

-	5.70	2-1469491-4	2
-	4.20	2-1469491-3	2
-	2.60	2-1469491-2	2
5	5.70	1-1469491-4	
5	4.20	1-1469491-3	
5	2.60	1-1469491-2	
-	5.70	1469491-4	2
-	4.20	1469491-3	2
-	2.60	1469491-2	2
FINISH	DIM "G"	PART NUMBER	

THIS DRAWING IS A CONTROLLED DOCUMENT.		DWN R. TREA 24FEB2004	TE Connectivity	
DIMENSIONS: mm		CHK B. PATERSON 24FEB2004		
TOLERANCES UNLESS OTHERWISE SPECIFIED:		APVD G. GRIFFITH 24FEB2004	NAME KEYED GUIDE PIN, DIE CAST BACKPLANE CONNECTOR, MULTIGIG, THREADED POST	
0 PLC ± 1 PLC ±0.5 2 PLC ±.13 3 PLC ±0.013 4 PLC ± ANGLES ± FINISH ±		PRODUCT SPEC 108-2072	SIZE A200779	
MATERIAL		APPLICATION SPEC 114-13056	DRAWING NO C-1469491	
1		WEIGHT -	RESTRICTED TO -	
2		CUSTOMER DRAWING		
		SCALE 5:1	SHEET 1 OF 2 REV B2	

THIS DRAWING IS UNPUBLISHED. RELEASED FOR PUBLICATION 20
 © COPYRIGHT 20 BY - ALL RIGHTS RESERVED.

LOC	DIST	REVISIONS			
P	LTR	DESCRIPTION	DATE	DWN	APVD
CG	00	SEE SHEET 1			

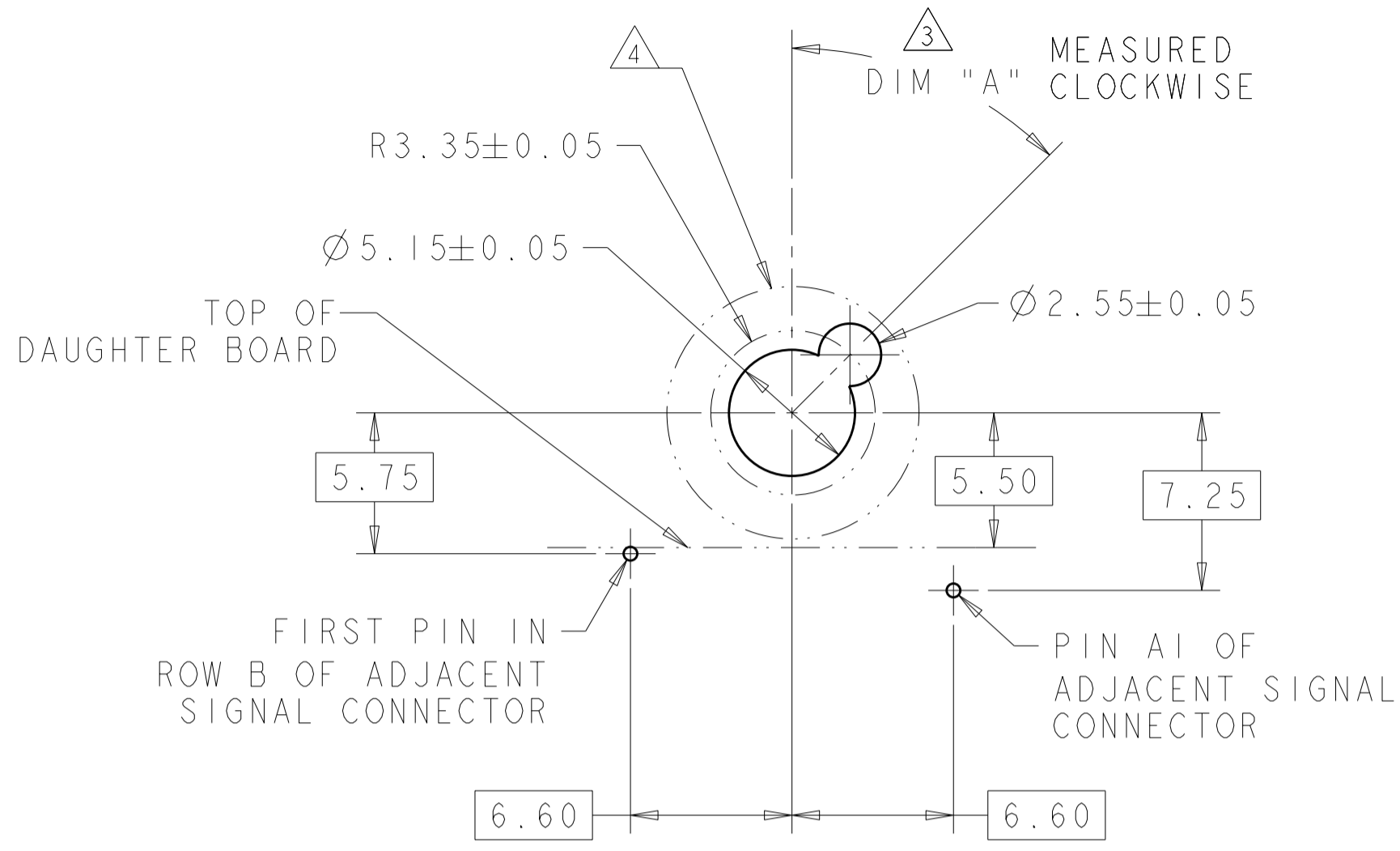

TIER 1
 GUIDE PIN FOOTPRINT
 (20.3 & 25.4mm SIGNAL MODULES)
 SCALE 4:1

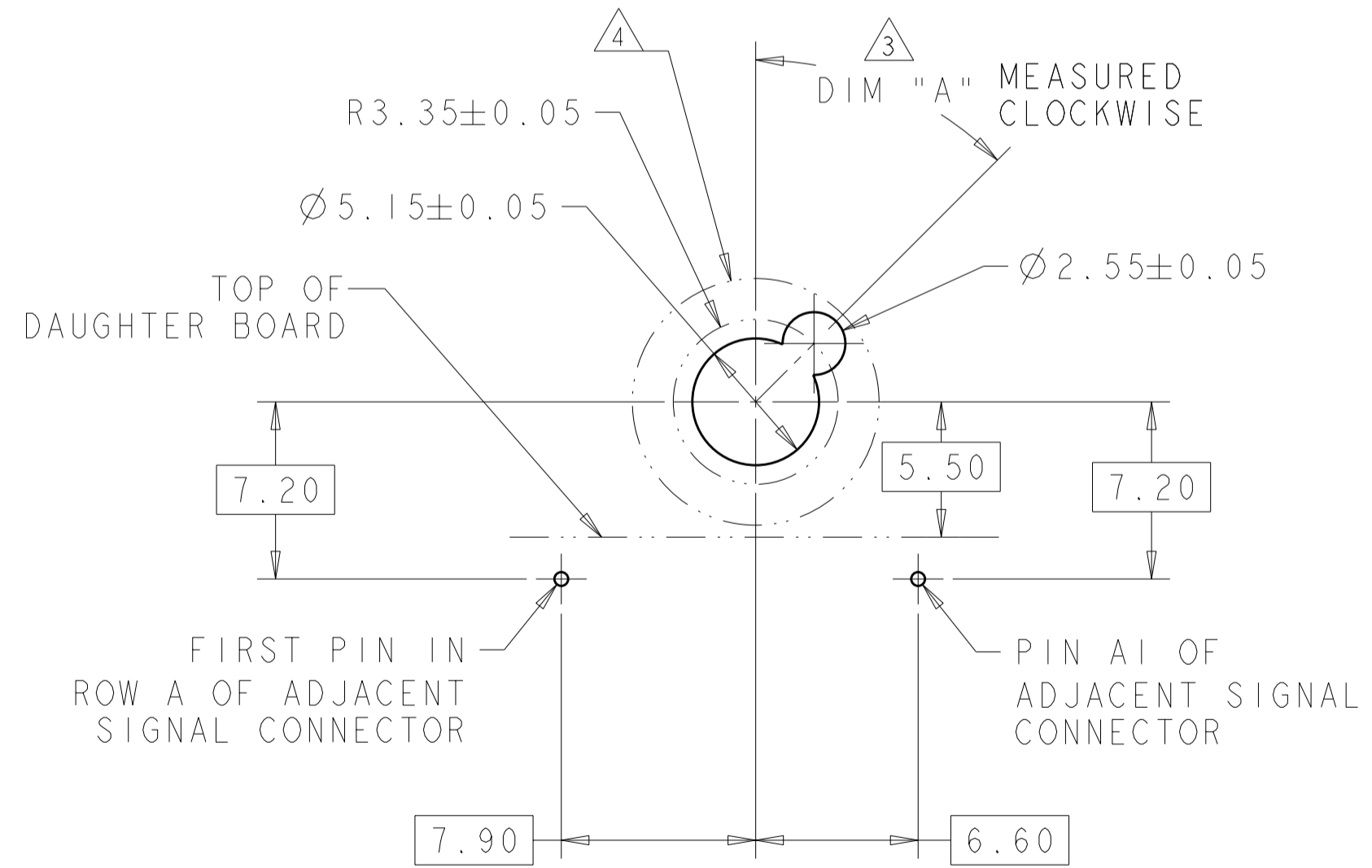

TIER 2
 GUIDE PIN FOOTPRINT
 (20.3mm SIGNAL MODULES)
 SCALE 4:1

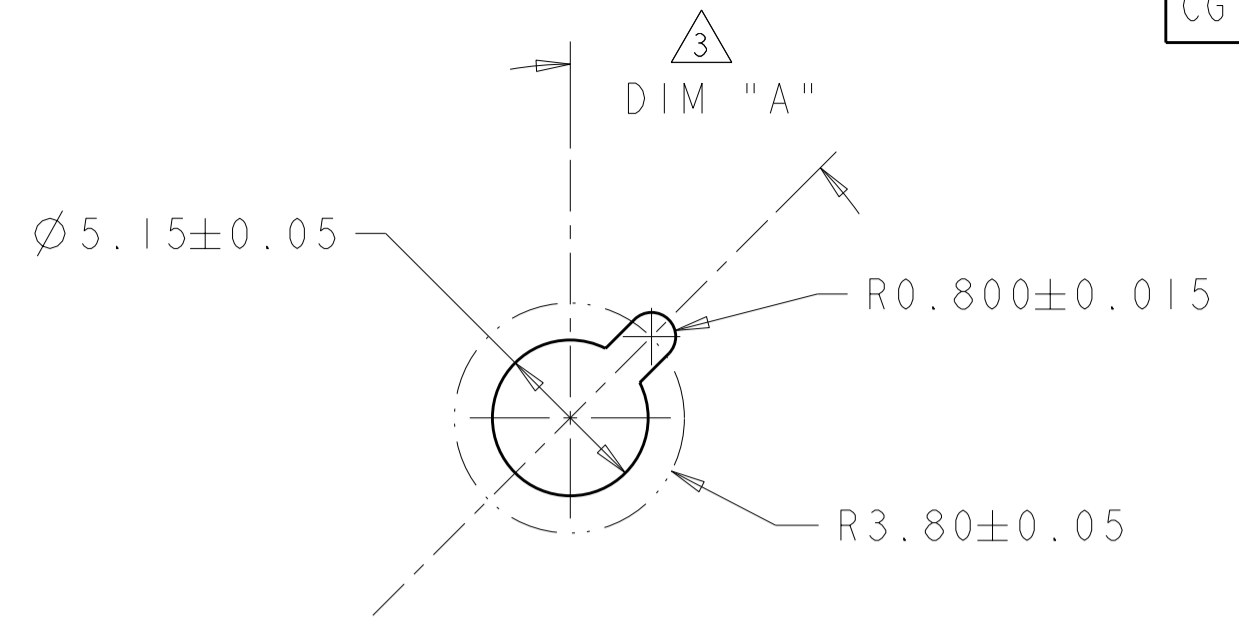

ALTERNATE PCB LAYOUT
 FOR GUIDE POST
 SCALE 4:1

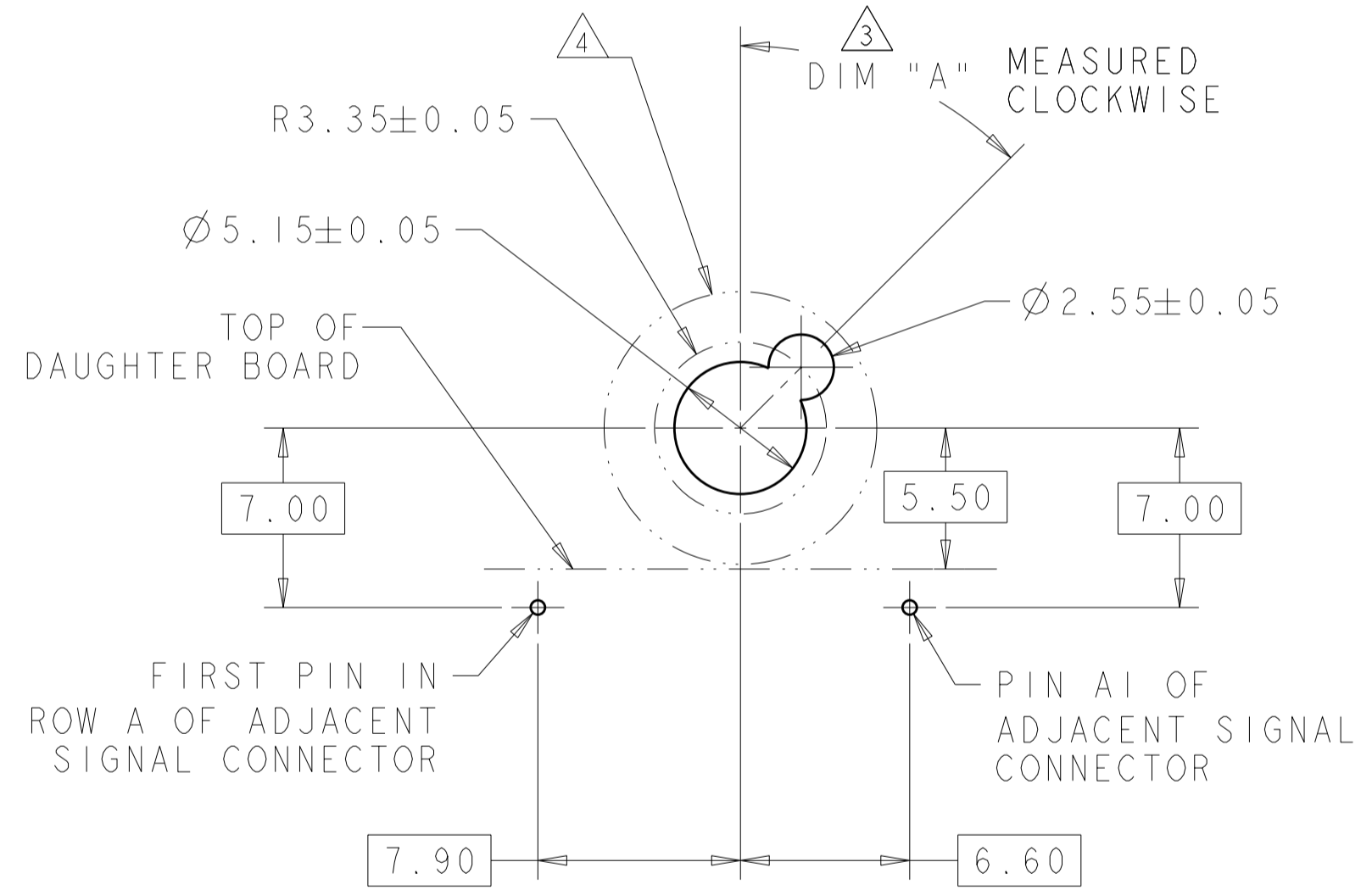

TIER 2
 GUIDE PIN FOOTPRINT
 (25.4mm SIGNAL MODULES)
 SCALE 4:1

-	-	-
-	-	-
-	-	-
-	-	-
-	-	-
-	-	-
5	-	1-1469492-9
5	315°	1-1469492-8
5	270°	1-1469492-7
5	90°	1-1469492-3
5	45°	1-1469492-2
5	0°	1-1469492-1
-	-	-
-	-	-
-	-	-
-	-	-
FINISH	DIM "A"	20.3mm GUIDE MODULE
MATING GUIDE MODULE 3		

THIS DRAWING IS A CONTROLLED DOCUMENT.

DWN	R. TREA	24FEB2004
CHK	B. PATERSON	24FEB2004
APVD	G. GRIFFITH	24FEB2004
PRODUCT SPEC	108-2072	
APPLICATION SPEC	114-13056	
MATERIAL	WEIGHT	-
CUSTOMER DRAWING		

TE Connectivity

KEYED GUIDE PIN, DIE CAST BACKPLANE CONNECTOR, MULTIGIG, THREADED POST

SIZE	A2	CAGE CODE	00779	DRAWING NO	C-1469491	RESTRICTED TO	-
SCALE	1:1	SHEET	2	OF	2	REV	B2

Mouser Electronics

Authorized Distributor

Click to View Pricing, Inventory, Delivery & Lifecycle Information:

[TE Connectivity:](#)

[1-1469491-2](#)