

6-Line ESD Protection Diode Array in LLP75

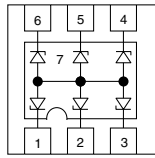

19371

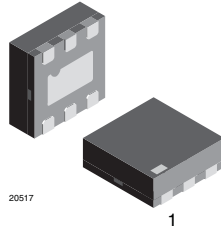

20517

1

MARKING (example only)



Dot = pin 1 marking

XX = date code

YY = type code (see table below)

DESIGN SUPPORT TOOLS

[click logo to get started](#)

3D
Models
Available

FEATURES

- Ultra compact LLP75-7L package
- 6-line ESD protection
- Low leakage current $I_R < 0.1 \mu A$
- Low load capacitance $C_D = 13 \text{ pF}$
- ESD immunity acc. IEC 61000-4-2 $\pm 15 \text{ kV}$ contact discharge $\pm 15 \text{ kV}$ air discharge
- Working voltage range $V_{RWM} = 5 \text{ V}$
- e4 - precious metal (e.g. Ag, Au, NiPd, NiPdAu) (no Sn)
- Material categorization: for definitions of compliance please see www.vishay.com/doc?99912



RoHS
COMPLIANT
HALOGEN
FREE
GREEN
(5-2008)

ORDERING INFORMATION

DEVICE NAME	ORDERING CODE	TAPED UNITS PER REEL (8 mm TAPE ON 7" REEL)	MINIMUM ORDER QUANTITY
VESD05A6A-HAF	VESD05A6A-HAF-GS08	3000	15 000

PACKAGE DATA

DEVICE NAME	PACKAGE NAME	TYPE CODE	WEIGHT	MOLDING COMPOUND FLAMMABILITY RATING	MOISTURE SENSITIVITY LEVEL	SOLDERING CONDITIONS
VESD05A6A-HAF	LLP75-7L	AT	4.2 mg	UL 94 V-0	MSL level 1 (according J-STD-020)	Peak temperature max. 260 °C

ABSOLUTE MAXIMUM RATINGS VESD05A6A-HAF

PARAMETER	TEST CONDITIONS	SYMBOL	VALUE	UNIT
Peak pulse current	BiAs-Mode: each input (pin 1 - pin 6) to ground (pin 2); acc. IEC 61000-4-5; $t_p = 8/20 \mu s$; single shot	I_{PPM}	2.5	A
	BiSy-mode: each input (pin 1 - pin 6) to any other input pin. Pin 2 not connected. Acc. IEC 61000-4-5; $t_p = 8/20 \mu s$; single shot	I_{PPM}	2.5	A
Peak pulse power	BiAs-mode: each input (pin 1 - pin 6) to ground (pin 2); acc. IEC 61000-4-5; $t_p = 8/20 \mu s$; single shot	P_{PP}	33	W
	BiSy-mode: each input (pin 1 - pin 6) to any other input pin. Pin 2 not connected. Acc. IEC 61000-4-5; $t_p = 8/20 \mu s$; single shot	P_{PP}	43	W
ESD immunity	Acc. IEC 61000-4-2; 10 pulses BiAs-mode: each input (pin 1 - pin 6) to ground (pin 2)	Contact discharge	± 15	kV
		Air discharge	± 15	kV
	Acc. IEC 61000-4-2; 10 pulses BiSy-mode: each input (pin 1 - pin 6) to any other input pin. Pin 2 not connected	Contact discharge	± 10	kV
		Air discharge	± 10	kV
Operating temperature	Junction temperature	T_J	-40 to +125	°C
Storage temperature		T_{STG}	-55 to +150	°C

APPLICATION NOTE

With the VESD05A6A-HAF 6 different signal or data lines can be clamped to ground. Due to the different clamping levels in forward and reverse direction the VESD05A6A-HAF clamping behavior is bidirectional and asymmetrical (BiAs).

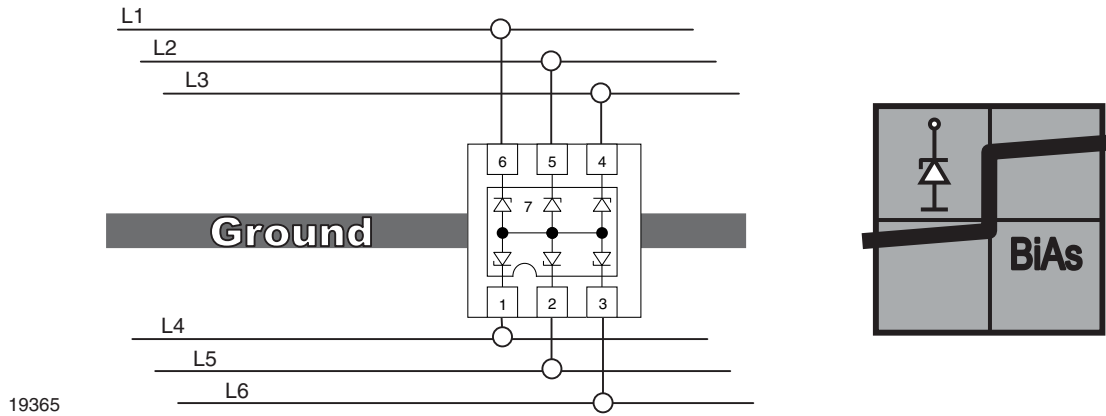

If symmetrical clamping behaviour is required the VESD05A6A-HAF can also be used as a bidirectional symmetrical protection device protecting up to 5 lines. In this case pin no. 7 must not be connected.

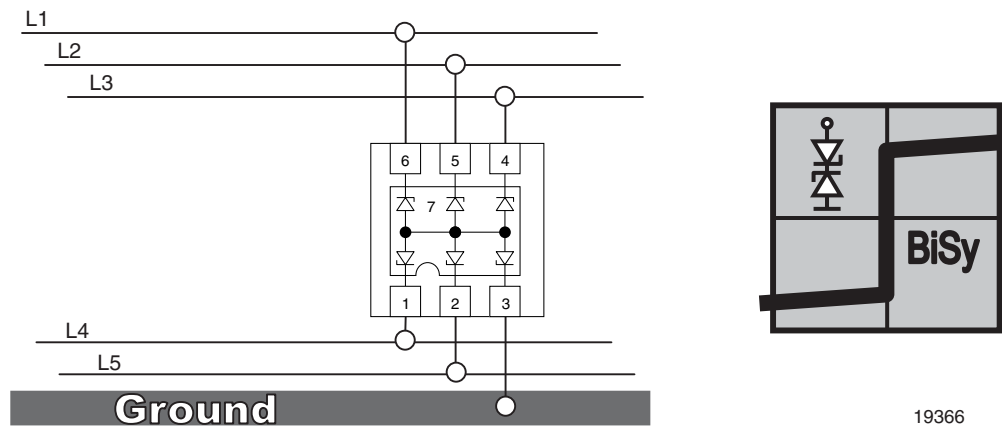

ELECTRICAL CHARACTERISTICS VESD05A6A-HAF (Between pin 1, 2, 3, 4, 5 or 6, and pin 7) ($T_{amb} = 25\text{ }^{\circ}\text{C}$, unless otherwise specified)						
PARAMETER	TEST CONDITIONS/REMARKS	SYMBOL	MIN.	TYP.	MAX.	UNIT
Protection paths	Number of lines which can be protected	$N_{channel}$	-	-	6	lines
Reverse stand-off voltage	Max. reverse working voltage	V_{RWM}	-	-	5	V
Reverse voltage	at $I_R = 0.1\text{ }\mu\text{A}$	V_R	5	-	-	V
Reverse current	at $V_R = 5\text{ V}$	I_R	-	< 0.01	0.1	μA
Reverse breakdown voltage	at $I_R = 1\text{ mA}$	V_{BR}	6	6.7	7.5	V
Reverse clamping voltage	at $I_{PP} = 1\text{ A}$	V_C	-	9	10	V
	at $I_{PP} = I_{PPM} = 2.5\text{ A}$	V_C	-	12	13	V
Forward clamping voltage	at $I_{PP} = 1\text{ A}$	V_F	-	2	2.5	V
	at $I_{PP} = I_{PPM} = 2.5\text{ A}$	V_F	-	3.2	4	V
Capacitance	at $V_R = 0\text{ V}$; $f = 1\text{ MHz}$	C_D	-	13	15	pF
	at $V_R = 2.5\text{ V}$; $f = 1\text{ MHz}$	C_D	-	8	-	pF



TYPICAL CHARACTERISTICS ($T_{amb} = 25\text{ }^{\circ}\text{C}$, unless otherwise specified)

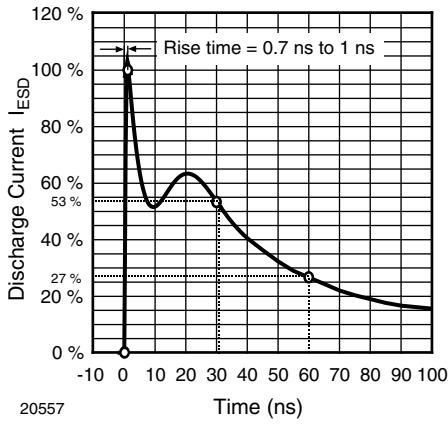

Fig. 1 - ESD Discharge Current Wave Form acc. IEC 61000-4-2 (330 Ω /150 pF)

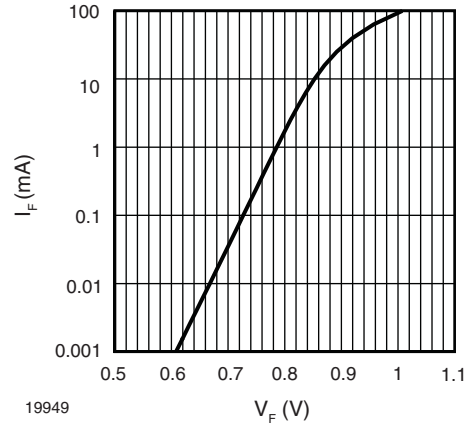

Fig. 4 - Typical Forward Current I_F vs. Forward Voltage V_F

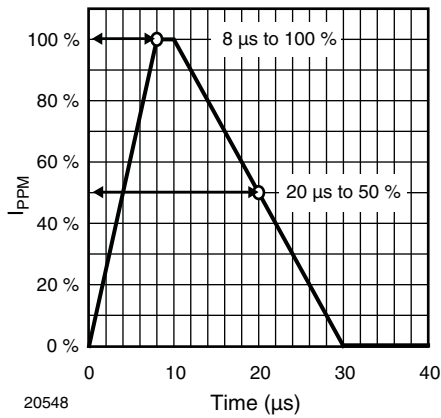

Fig. 2 - 8/20 μs Peak Pulse Current Wave Form acc. IEC 61000-4-5

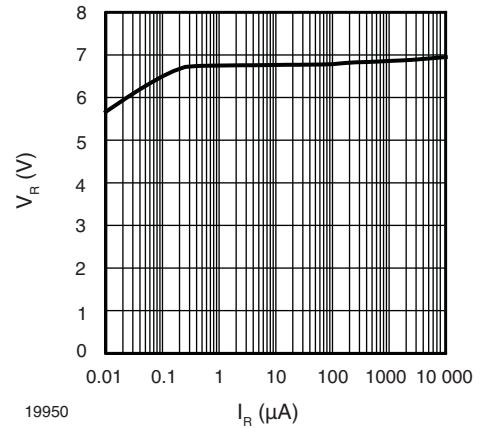

Fig. 5 - Typical Reverse Voltage V_R vs. Reverse Current I_R

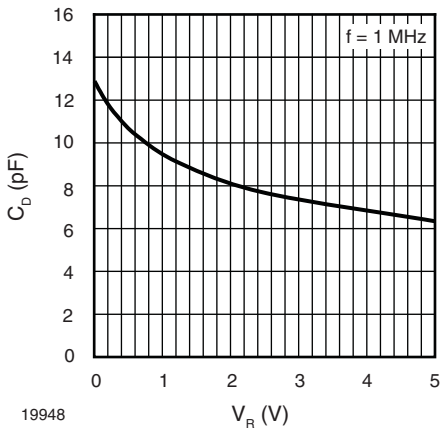

Fig. 3 - Typical Capacitance C_D vs. Reverse Voltage V_R

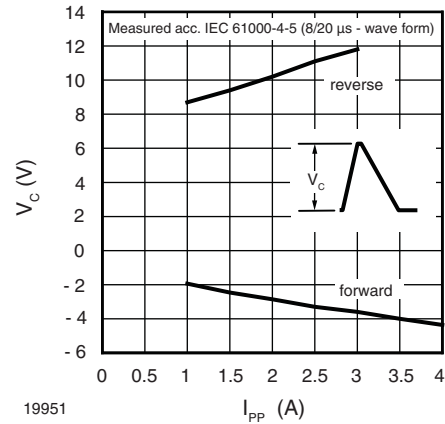

Fig. 6 - Typical Peak Clamping Voltage V_C vs. Peak Pulse Current I_{PP}

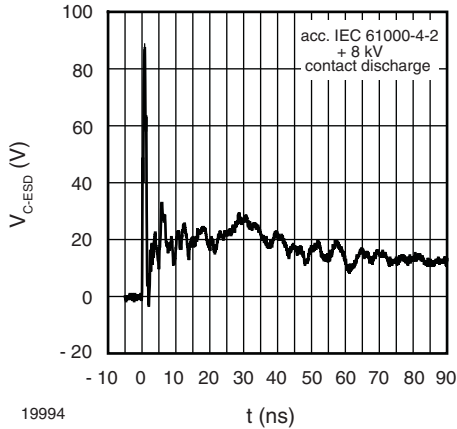

Fig. 7 - Typical Clamping Performance at + 8 kV Contact Discharge (acc. IEC 61000-4-2)

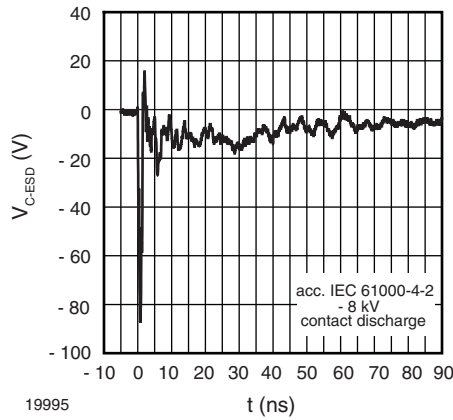

Fig. 8 - Typical Clamping Performance at - 8 kV Contact Discharge (acc. IEC 61000-4-2)

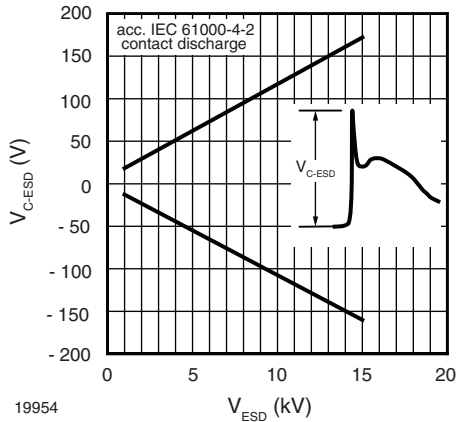
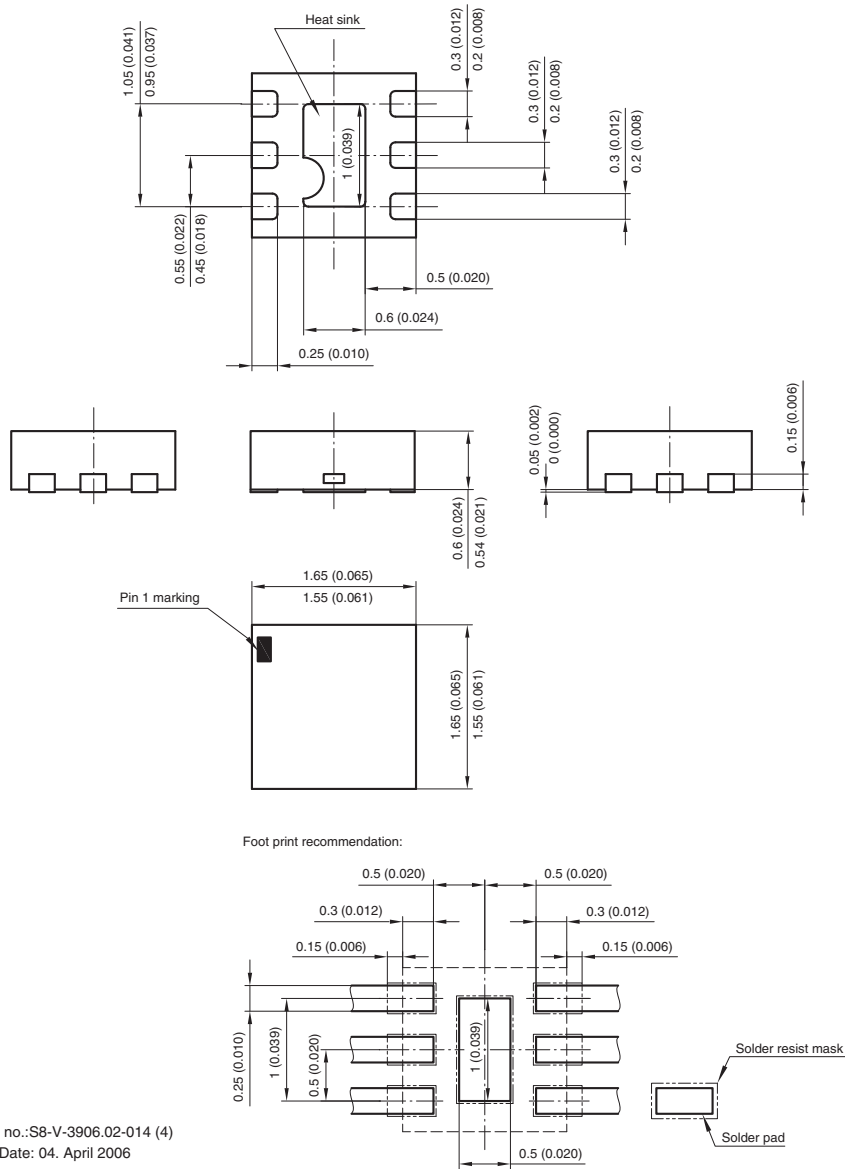
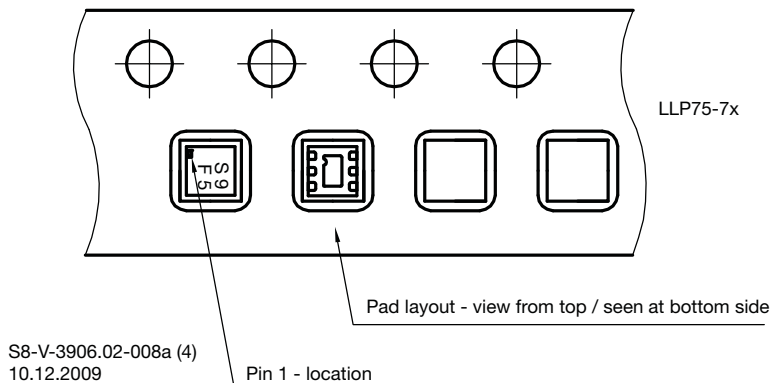

Fig. 9 - Typical max. Clamping Voltage at ESD Contact Discharge (acc. IEC 61000-4-2)

PACKAGE DIMENSIONS in millimeters (Inches): **LLP75-7L**



Document no.: S8-V-3906.02-014 (4)
Created - Date: 04. April 2006
20500



S8-V-3906.02-008a (4)
10.12.2009



Disclaimer

ALL PRODUCT, PRODUCT SPECIFICATIONS AND DATA ARE SUBJECT TO CHANGE WITHOUT NOTICE TO IMPROVE RELIABILITY, FUNCTION OR DESIGN OR OTHERWISE.

Vishay Intertechnology, Inc., its affiliates, agents, and employees, and all persons acting on its or their behalf (collectively, "Vishay"), disclaim any and all liability for any errors, inaccuracies or incompleteness contained in any datasheet or in any other disclosure relating to any product.

Vishay makes no warranty, representation or guarantee regarding the suitability of the products for any particular purpose or the continuing production of any product. To the maximum extent permitted by applicable law, Vishay disclaims (i) any and all liability arising out of the application or use of any product, (ii) any and all liability, including without limitation special, consequential or incidental damages, and (iii) any and all implied warranties, including warranties of fitness for particular purpose, non-infringement and merchantability.

Statements regarding the suitability of products for certain types of applications are based on Vishay's knowledge of typical requirements that are often placed on Vishay products in generic applications. Such statements are not binding statements about the suitability of products for a particular application. It is the customer's responsibility to validate that a particular product with the properties described in the product specification is suitable for use in a particular application. Parameters provided in datasheets and / or specifications may vary in different applications and performance may vary over time. All operating parameters, including typical parameters, must be validated for each customer application by the customer's technical experts. Product specifications do not expand or otherwise modify Vishay's terms and conditions of purchase, including but not limited to the warranty expressed therein.

Except as expressly indicated in writing, Vishay products are not designed for use in medical, life-saving, or life-sustaining applications or for any other application in which the failure of the Vishay product could result in personal injury or death. Customers using or selling Vishay products not expressly indicated for use in such applications do so at their own risk. Please contact authorized Vishay personnel to obtain written terms and conditions regarding products designed for such applications.

No license, express or implied, by estoppel or otherwise, to any intellectual property rights is granted by this document or by any conduct of Vishay. Product names and markings noted herein may be trademarks of their respective owners.