

REV.	ECH NO	LOCATIONS	DESCRIPTION	DATE

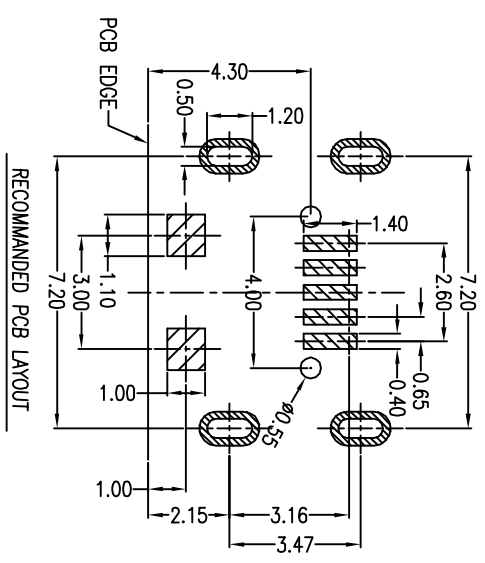
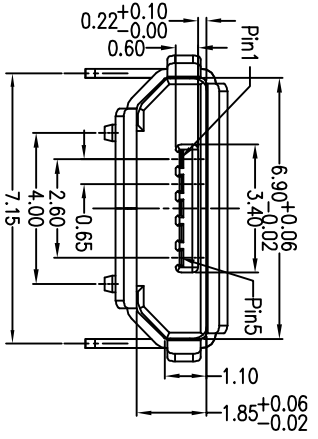
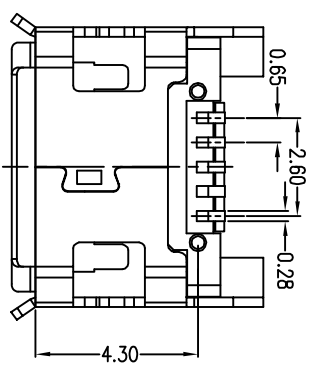
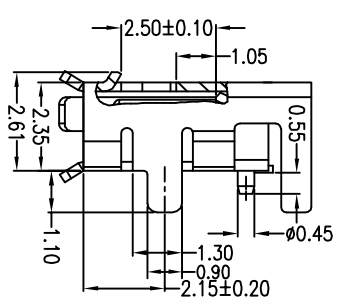
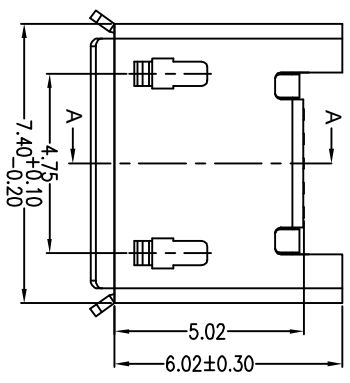
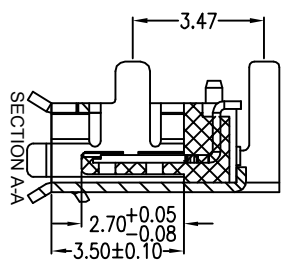
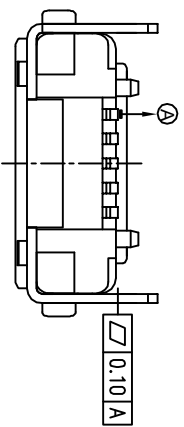

- Note:
- Material:
    - Housing: High temperature thermoplastic with g.f, UL94V-0
    - Contact: copper alloy, t=0.20mm
    - Shell: copper alloy, t=0.25mm
  - Specification:
    - Current rating: 1 A Max. voltage: 100 V(ac) for 1 min.
    - Dielectric withstanding
    - Contact resistance: 50 mW Max.
    - Insulation resistance: 100 MW Min.
    - Total mating force: 3.57 Kgf Max.
    - Total unmating force: 1.0 Kgf Min. 0.81~2.05 Kgf Min.
    - Temperature range: -30°C~80°C

**A 01 S B 1 4 1 B 1-276**

- 产品代号 A: 精品
- 产品系列 01: micro usb 5pin
- 产品类别 S: 母座
- 产品类型 B: B TYPE
- 外壳材质 1: 29800R-H
- 端子材质 4: 5181R-B
- 主体材质 1: 10P
- 主体颜色 B: 黑色
- 下板类型 1: d1p (插板)
- 细节流水 276: micro usb 5P/B Type SMT DIP7 2插板板长1.1四脚全插

PART NO:	A01SB141B1-276	MATERIAL:	SEE NOTE
MODEL NO:	XX	FINISH:	SEE NOTE
UNIT:	MM	COLOR:	SEE NOTE
SIZE:	A4	DR:	xiayoulong
TOLERANCE UNSPECIFIED	.x	CHK:	
	.xx	APP:	
	.xxx	SCALE:	5:1
	Ang.	DATE:	2012.05.21

**深圳市精拓金电子有限公司**

TITLE: Micro usb 5P/F B Type SMT DIP7.2 有挂脚长1.1四脚全插

DWG NO: A276

SCALE: 5:1

