

LED DRIVER SPECIFICATIONS

Customer's Part Number: _____

MOONS' Part Number: _____

Model: **MU050H070AQ_CLKS**

P/N: _____

CUSTOMER'S APPROVAL STAMP

Please sign back after your approval. The specifications will come into force when we receive purchase order.

DWG	CHK	STANDARD	APPD

Rev.	Date	Contents	ECO NO.	DWG	CHK	APPR
A0	2016-1-27	First release				

- **Features**
- Input voltage: 90-305VAC
 - Built-in active PFC function: 0.99 Typ.
 - Low THD: 10% Typ.
 - High efficiency: 90% Typ.
 - IP67 design for indoor or outdoor installations
 - High surge immunity
 - Support Time-shared dimming function
 - Compliance to worldwide safety regulations for lighting
 - Suitable for dry/damp locations



■ Specification			
MU050H070AQ_CLKS			
Input	Efficiency(120Vac) _{Note.1}	89%(Typ.)	
	Efficiency(230Vac) _{Note.1}	90%(Typ.)	
	Voltage Range (V) _{Note.2}	90 ~ 305Vac, OR 127~ 430Vdc	
	Voltage Rated (V) _{Note.2}	100-277Vac	
	Frequency Range (Hz)	47~63	
	Power Factor		0.99 (Typ.)with 80%-100% load,at 120Vac
			0.96(Typ.) with 80%~100% load,at 230Vac
			>0.9 with 80%~100% load, at 100~277Vac
	THD	<20%,at 100/230/277Vac input, with 80%~100% load conditions	
	AC Current(Max)	0.7A at 100VAC input, 0.35A at 230VAC	
Inrush Current(Max.)	50A at 230Vac input 25°C Cold Start (time wide=500uS, measured at 50% Ipeak,Not applicable for the inrush current to Noise Filter for less than 0.2ms)		
Leakage Current(Max.)	0.75mA at 277Vac/60Hz		
Output	Output Voltage range (V)	36-72	
	Rated Current(mA)	700	
	Rated Power (W)	50	
	Ripple Current	<30%((PK-AV)/AV) full load)	
	Current Tolerance	5%	
	Line Regulation	3%	
	Load Regulation	3%	
	Current ADJ. Range	-	
Turn on delay Time	<2s, at 120Vac; <1s, at 230Vac (When the light begins to shine)		
Protection	Over Voltage(V)	<95	
	Short Circuit	Protection type: Voltage limiting.output will not exceed the upper limit voltage , recovers automatically after fault condition is removed.	
	Over temperature	Protection type: Resumable mode.when the inside temperature of PSU rise to 110°C(Typ.), the PSU will shut down or output current will reduce to almost no;The power supply should resume its normal operation when the inside temperature of PSU drop to normal temperature.	
Environment	Operating Temp.	-40~+70°C(Refer to 'Derating Curve')	
	Tc	88.9°C max	
	Operating Humidity	20~95% RH non-condensing	
	Storage Temp., Humidity	-40~+85°C , 10-95%RH	
	Temp. Coefficient	0.03%/°C (0~50°C)	
	Vibration	10-500Hz,5G 12min/cycle , period for 72min each along X、 Y、 Z axes	
Safety & EMC	Safety Standard	UL8750, UL1012, CSA C22.2 No.107.1, EN61347-1, EN61347-2-13, GB19510.1, GB19510.14	
	Withstand Voltage	I/P-O/P:3.75KVac, I/P-FG:1.875KV, O/P-FG:1.5KV	
	Isolation Resistance	I/P-O/P, I/P-FG, O/P-FG:100M Ohms/500Vdc/25°C/70%RH	
	EMC Emission	EN55015/FCC Part 15 Class B, EN61000-3-2 Class C, EN61000-3-3	
	EMC Immunity	EN61000-4-2,3,4,5,6,8,11, EN61547 (Surge: L-N 4KV, L/N-Earth 6KV)	
Others	MTBF	300,000 Hours,measured at full load,25°C ambient temperature	
	Lifetime	50,000 Hours at Tc 75°C(Refer to"Life Time VS. Tcase (Ref.)")	
	Dimension	193 x 42.5 x 34.5 mm (LxWxH)	
	Weight(Typ.)	0.55kg	

Note.1: Measured at full load and steady-state temperature in 25°C ambient(Efficiency will be about 2% lower if measured immediately after startup); Note. 2: Derating may be needed under low input voltages , Please Refer to 'Derating Curve' ; Note. 3: All parameters NOT specially mentioned are measured at 230VAC input , rated load and 25°C ambient temperature ;

subject to change without notice

Page 3 of 8

SHANGHAI MOONS' AUTOMATION CONTROL CO., LTD.

Add: No.168, Mingjia Road, Shanghai 201107, P.R.China

Tel: +86 (0)21 52634688 Website: www.moons.com.cn

Derating Curve

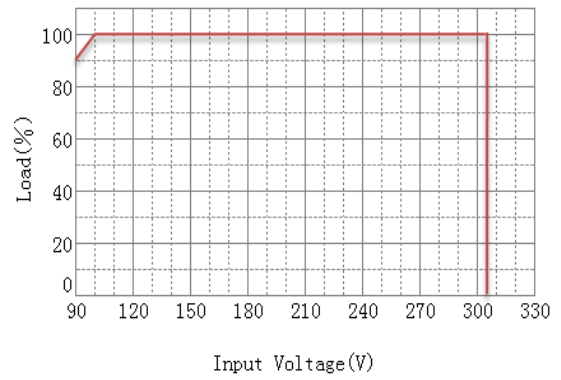
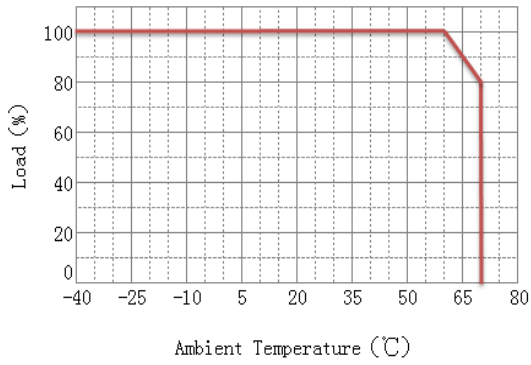

Power Factor VS. Load Curve

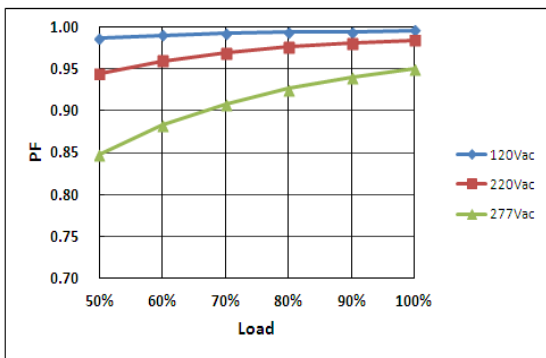

Efficiency VS. Load Curve(Ref.)

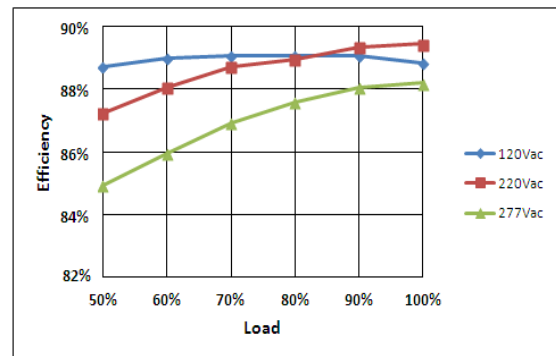

THD Curve(Ref.)

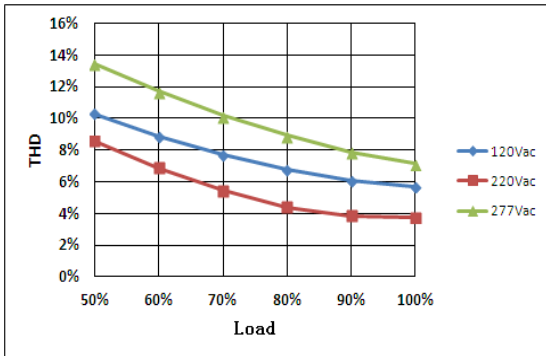

Life Time VS. Tcase (Ref.)

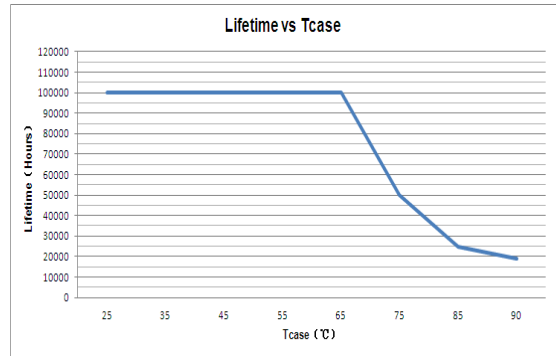

Instruction

1.Field Programmable Topology

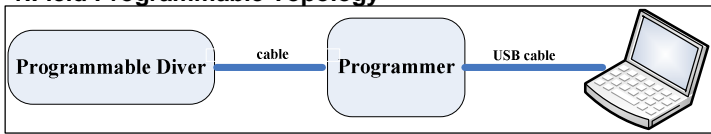

The programmable driver can be programmed by using special PC software and the programmer module.

2.Dimming Interface Description

Pin description

Pin	Name	Value	Description
1	Vaux 12V	9V-13.2V	Passive dimmers power supply
2	Dim+/Program	0-10V	Dimming/Programming input
3	Dim-	0V	DC Ground

CLKS DIMMING PROGRAMMING INTERFACE

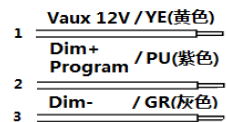

3.Dimming Software Function Instruction

Adjustable Output Current(AOC)

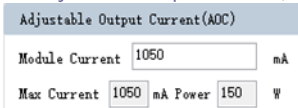

Users can set the rated current between 10%*Max Current and 100%*Max Current

PWM

Input a PWM signal from the 2nd pin(Dim+/Program) of the dimming interface to change the output current. User can set "Positive Logic" or "Negative Logic" of the PWM signal. PWM duty cycle: 1%~99%(it has both positive and negative logics), frequency: 500Hz~5kHz, 3V~10V is high, 0.3V~0.8V is low.

Adjustable Startup Time(AST)



Set driver's "Start Fade up Time". It means how much time the driver costs to achieve the "Module Current" that the user set. The valid value is 0s, 1s, 2s, 5s, 10s, 20s, 40s.

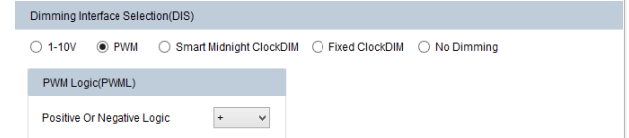

Fade Time(FT)



Set driver's "Fade up Time". This function is available in the Smart Midnight ClockDIM and Fixed ClockDIM mode; It means how much time the driver costs to achieve another dimming level from previous dimming level. The valid value is 0s, 1s, 2s, 5s, 10s, 20s, 40s.

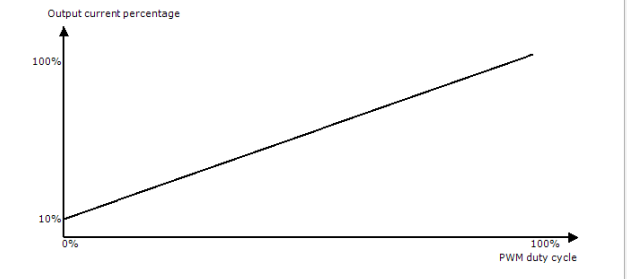

1-10V

Allow users to set the max and min output current and corresponding output voltage to clarify the 1-10V dimming curve. Input a 0~10V signal from 2nd pin of the dimming interface. Default: input ≤1V, output current 10%; input ≥8.5V, output current 100%.

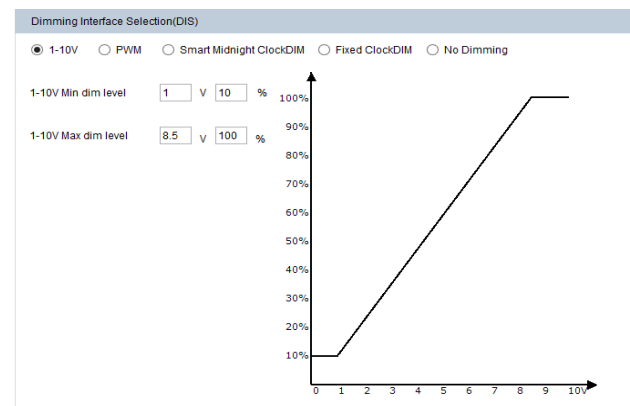

Instruction

Integrated Dynadimmer

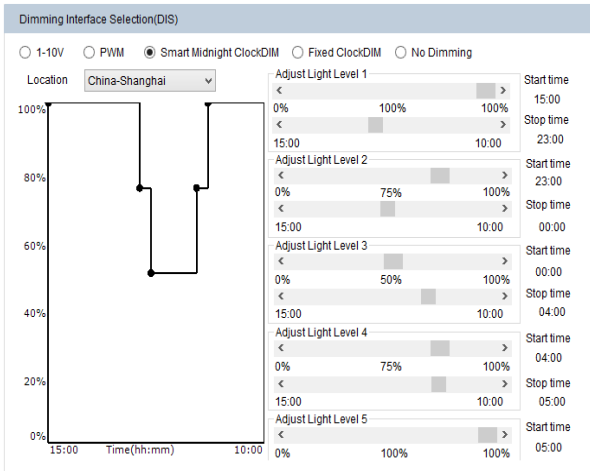

Integrated Dynadimmer allows dimming to predefined light levels based on the nightly operating time. With flexibility in setting time and light levels, the user can configure the driver for specific locations and application needs. Using Integrated Dynadimmer, it is possible to set up to 5 dim levels and time intervals. The driver does not have a real time clock. Instead it runs a virtual clock, determined by the length of nightly operating hours. After 3 ON-OFF cycles, the driver will calculate the virtual clock time. A valid ON-time is defined as a period during which the driver operates continuously for ≥ 4 hours to ≤ 24 hours. For example, if the requirement in summer is: 23:00-00:00: 75%, 00:00-04:00: 50%, 04:00-05:00: 75% (other time 100% or Off). The driver should be powered on for 7h, so it can calculate the virtual clock time as 22:00. Then we can set the dimming plan: 22:00-23:00: 100%, 23:00-00:00: 75%, 00:00-04:00: 50%, 04:00-05:00: 75%. From summer to winter, the valid ON-time changes day by day. The driver should be powered on for 17h in winter, and it also can calculate the virtual clock time as 17:00. Then the dimming plan is 17:00-23:00: 100%, 23:00-00:00: 75%, 00:00-04:00: 50%, 04:00-05:00: 75%, 05:00-10:00: 100%. From the above, if we set the dimming plan as shown in the picture, after repeating the driver ON-time for 3 consecutive days, the dimming plan takes effect from the 4th day onwards. Each day the driver powered on, it has a different start time according to the virtual clock time. So the driver can satisfy different requirements for different seasons.

Integrated Dynadimmer Time Based

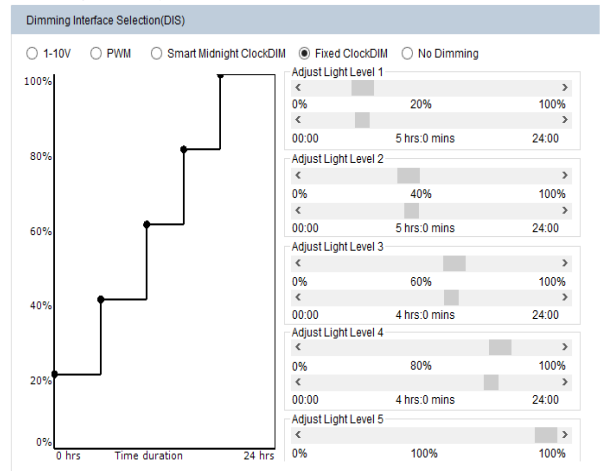

Allow users to separate 24hrs into 5 sections and corresponding output current.

No Dimming



The driver will be in constant output mode.

Set MODULE Working hrs(SMW)

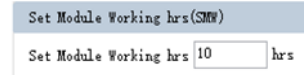

User can check how much time the driver works through this function.

Constant Light Output(CLO)

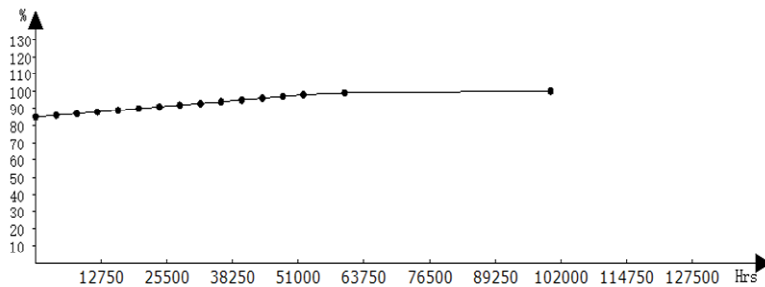
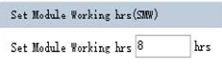
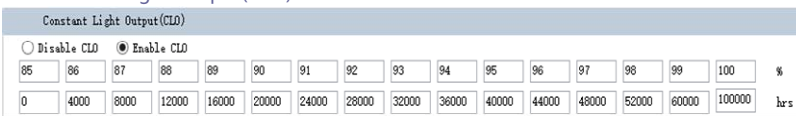

Traditional light sources suffer from depreciation in light output over time. This applies to LED light sources as well. The CLO feature enables LED solutions to deliver constant lumen output through the life of the light engine. Based on the type of LEDs used, heat sinking and driver current, it is possible to estimate the depreciation of light output for specific LEDs and this information can be entered into the driver. The driver counts the number of light source working hours and will increase output current based on this input to enable CLO. When the CLO feature is enabled, the driver nominal output current will be defined by the CLO percentage as shown by the equation below:
 $\text{Driver target nominal output current} = \text{CLO percentage} * \text{AOC}$
 For example, in the CLO profile shown in Figure, between 52,000-60,000 working hours, the CLO percentage is set at 98%. Assuming the nominal AOC is set to 500mA, the driver output current with CLO enabled will be $0.98 \times 500 = 600 \text{ mA}$.
 The CLO percentage can be set to a value between 85%-100%, in increments of 1%. The LED module working hours can be set at any value between (0-100,000 hours).

■ Programmable Plan

■ Adjustable Output Current(AOC)

Adjustable Output Current(AOC)			
Module Current	<input type="text" value="700"/>		mA
Max Current	<input type="text" value="700"/>	mA Power	<input type="text" value="50"/> W

■ Dimming

Dimming Interface Selection (DIS)									
<input checked="" type="radio"/>	1-10V	<input type="radio"/>	PWM	<input type="radio"/>	Integrated Dynadimmer	<input type="radio"/>	Integrated Dynadimmer Time Based	<input type="radio"/>	No Dimming

Factory default settings: 0-10V dimming

■ Mechanical Specification

Dimensions (Unit: mm)

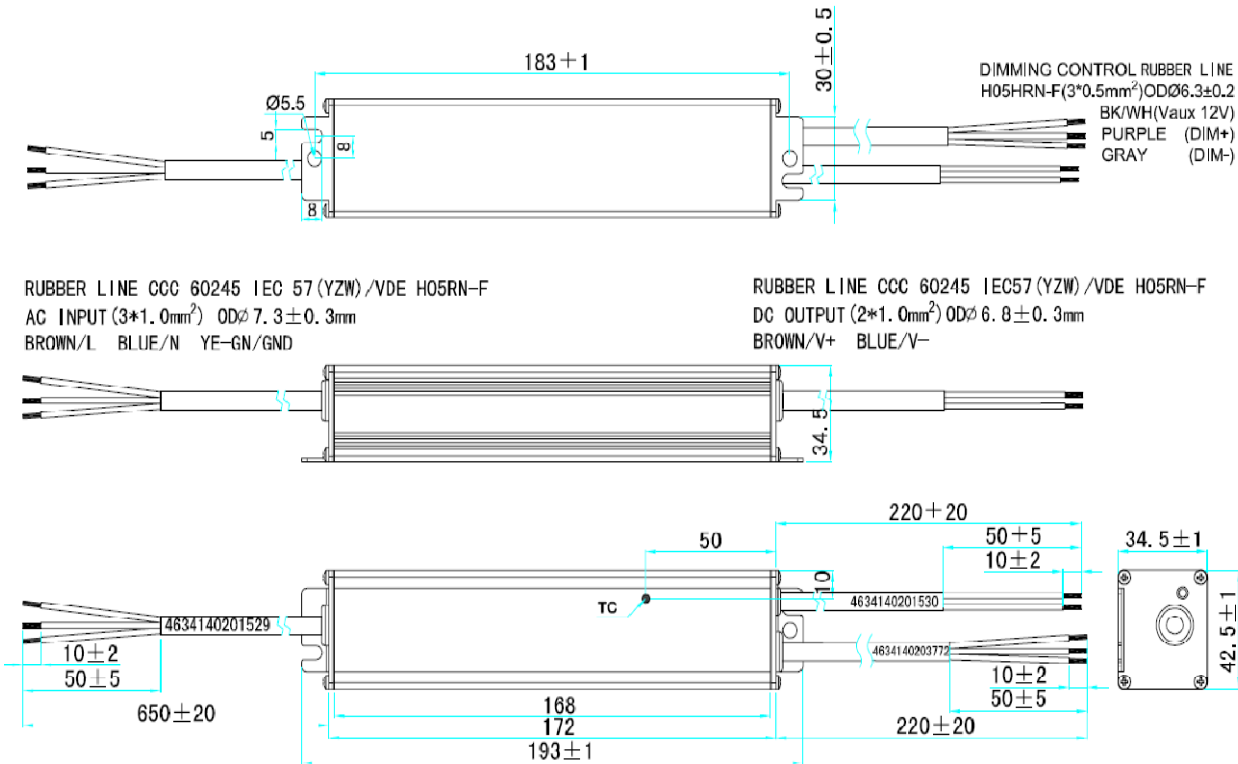

■ Nameplate

<p>● AC/L BROWN (棕色)</p> <p>● AC/N BLUE (蓝色)</p> <p>● YE-GN (黄绿色)</p> <p>INPUT (输入)</p>	<p>MOONS'</p> <p>LED Driver (LED控制装置) Energy Saving Solutions</p> <p>Http://www.moons.com.cn Http://www.moonsindustries.com</p> <p>SHANGHAI MOONS' AUTOMATION CONTROL CO.,LTD (上海鸣志自动控制设备有限公司) MADE IN CHINA (中国制造)</p>	<p>MU050H070AQ_CLKS</p> <p>P/N:</p> <p>Input Voltage (输入电压): 100-240Vac 50/60Hz Input Current (输入电流): 0.70A@100Vac Output Voltage (输出电压): 36-72Vdc Output Voltage (输出电压): 86Vdc Max Output Current (输出电流): 700mA Output Power (输出功率): 50W ta: 70°C tc: 90°C PF > 0.95</p>	<p>CE</p> <p>CCC</p> <p>110</p> <p>F</p> <p>SELV</p> <p>IP67</p> <p>RoHS</p>	<p>OUTPUT (输出)</p> <p>● V- BLUE (蓝色)</p> <p>● V+ BROWN (棕色)</p> <p>Vaux 12V BK/WH (黑白)</p> <p>Dim+ Program PU (紫色)</p> <p>Dim- GR (灰色)</p> <p>Dimming (调光)</p>
--	--	---	--	--

RoHS Compliance:

Our products comply with the European Directive 2002/95/EC, calling for the elimination of lead and other hazardous substances from electronic products.