



- **Features**
- Input voltage: 176-305Vac
 - Built-in active PFC function 0.98 Typ.
 - High efficiency: up to 93% Typ.
 - Built-in Lightning protection
 - Three dimming in one operation modes(0-10V Dimming / Clock Dimming(CLK)/PWM Dimming)
 - Protection: OVP, SCP, OTP
 - Full Power at 65%Iomax~100%Iomax (Constant Power)
 - IP67 design for indoor or outdoor installations

■ **Specification**

Model		080	105	150	210	300	420	600
(ME150HxxxAQ_CP)								
Input	Efficiency (230Vac)(Typ.) _{Note.1}	93.0%	93.0%	92.0%	91.0%	91.0%	90.0%	89.0%
	Voltage Range (V) _{Note.2}	176 ~ 305Vac, OR 250~ 430Vdc						
	Voltage Rated (V) _{Note.2}	200 ~ 240Vac						
	Frequency Range (Hz)	47~63						
	Power Factor	0.95 (Typ.) at 230Vac, 0.9 (Min.) at 277Vac, with 80%-100% load						
	THD	<15% at 220VAC input 50Hz,80%~100% load						
	AC Current (Max.)	0.85A at 230VAC input						
	Inrush Current (Max.)	65A at 230Vac input, 25°C, Cold Start (time wide=500uS, measured at 50% Ipeak,Not applicable for the inrush current to Noise Filter for less than 0.2ms)						
Output	Leakage Current (Max.)	0.75mA at 277VAC/60Hz input						
	Rated Output Voltage (V)	283-188	214-142	150-100	107-71	75-50	54-36	38-25
	Voltage Range (V) _{Note. 4:}	283-113	214-86	150-60	107-43	75-30	54-21	38-15
	Rated Current (mA)	530-800	700-1050	1000-1500	1400-2100	2000-3000	2800-4200	4000-6000
	Output Current Range (mA)	53-800	70-1050	100-1500	140-2100	200-3000	280-4200	400-6000
	Rated Power (W)	150(max)						
	Output Current Setting Range	6.5%Io_max~100%Io_max						
	Constant Power Setting Range	65%Io_max~100%Io_max						
	Ripple Current (Typ.)	10% of Io_max. ((PK-AV) /AV) with LED default mode and full load)						
	Current Tolerance	±5%						
	Line Regulation	±3%						
Load Regulation	±5%							
Turn on delay Time	1s(typ.), measured at 230Vac input							
Dimming Control	12Vdc Output Voltage (Vdc)	10.8Vmin.~13.2Vmax.						
	12Vdc Output Current(Vdc)	0mA~20mA max.						
	0~10V/DMi+ Voltage	Absolute maximum voltage -10Vmin~20Vmax						
	0~10V/DMi+ Short Current	280uA~450uA (DIM(+)=0)						
	DIMMING FUNCTION	Default 0-10V dimming mode.others Dimming modes set to PWM/Clock Dimming(CLK) by software configuration						
Protection	Over Voltage (V)(Typ.)	350	290	200	145	100	73	52
	Short Circuit	Protection type: Voltage limiting.output will not exceed the upper limit voltage , recovers automatically after fault condition is removed.						
	Over temperature	No damage.The power supply shall be self-recovery when the fault is removed.						
Environment	Operating Temp.	-40~+70°C(Refer to 'Derating Curve')						
	Tc	90°C max						
	Operating Humidity	20~95%RH						
	Storage Temp., Humidity	-40~+85°C , 10-95%RH						
	Temp. Coefficient	0.03%/°C (0~50°C)						
Safety & EMC	Vibration	10-500Hz, 5G 12min/cycle, period for 72min each along X, Y, Z axes						
	Safety Standard	EN61347-1, EN61347-2-13 ,EN60598-1,EN62384						
	Withstand Voltage	I/P-O/P:3.75KVAC I/P-FG:1.875KV O/P-FG:1.5KV						
	Isolation Resistance	I/P-O/P, I/P-FG, O/P-FG:100M Ohms/500Vdc/25°C/70%RH						
	EMC Emission	EN55015,EN61000-3-2 Class C,EN61000-3-3						
Others	EMC Immunity	EN61000-4-2,3,4,5,6,8,11 (Surge L,N-FG 10KV,L-N 10KV) , EN61547						
	MTBF	300,000 Hours, measured at full load, 25°C ambient temperature						
	Lifetime	50,000 Hours at Tc 75°C(Refer to"Life Time VS. Tcase (Ref.)")						
	Dimension	202 x 67.5 x 40 mm (LxWxH)						
	Weight (Typ.)	0.95kg						

Note.1: Measured at full load and steady-state temperature in 25°C ambient(Efficiency will be about 2% lower if measured immediately after startup); Note. 2: Derating may be needed under low input voltages , Please Refer to 'Derating Curve' ; Note. 3: All parameters NOT specially mentioned are measured at 230VAC input , rated load and 25°C of ambient temperature ; Note. 4: refer to V/I curve

■ **Operating Curve**

Derating Curve

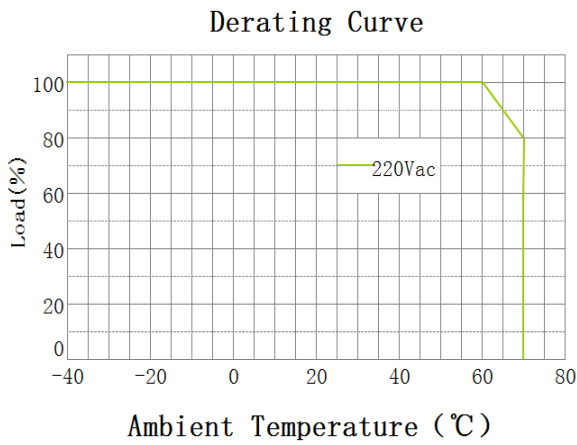

V/I Curve

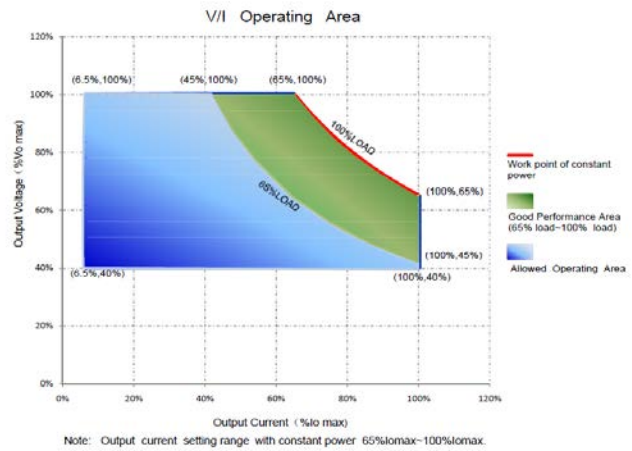

Lifetime vs. Case Temperature

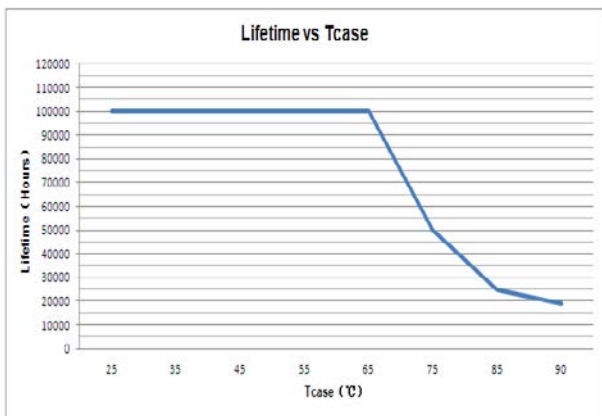

Power Factor Curve

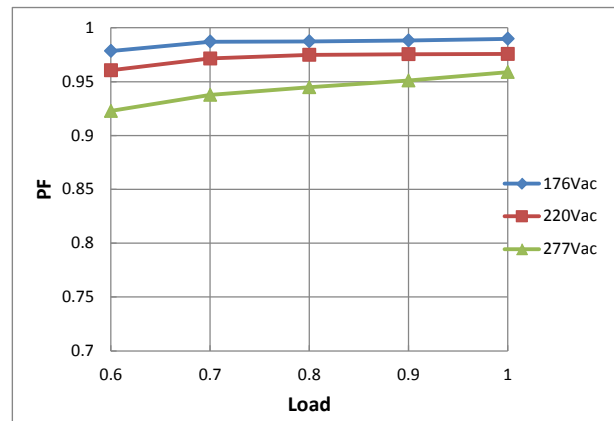

Efficiency VS. Load Curve (700mA typ.)

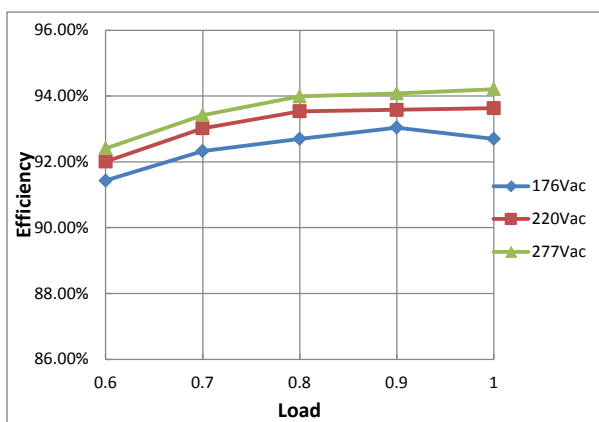

THD Curve

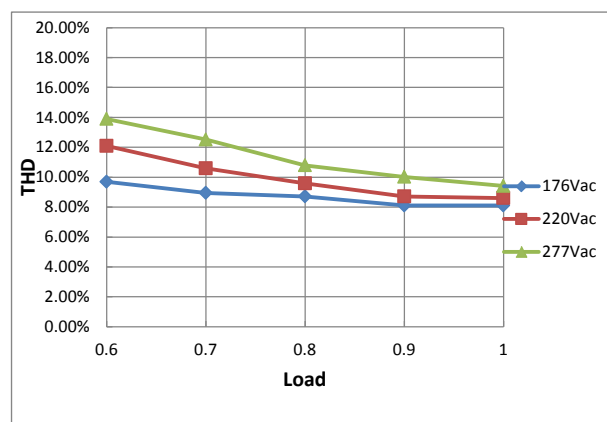

■ Instruction

1.Field Programmable Topology

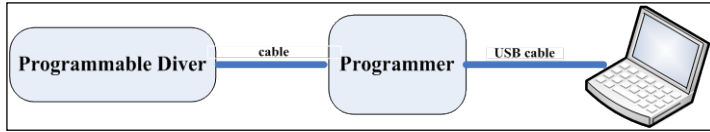

The programmable driver can be programmed by using special PC software and the programmer module.

2.Dimming Interface Description

Pin description

Pin	Name	Value	Description
1	Vaux 12V	10.8V-13.2V	Passive dimmers power supply
2	Dim+/Program	0-10V	Dimming/Programming input
3	Dim-	0V	DC Ground

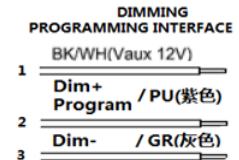

3.Dimming Software Function Instruction

■ Adjustable Output Current(AOC)

Adjustable Output Current(AOC)

Module Current mA

Max Current mA Power W

Users can set the rated current between 7%*Max Current and 100%*Max Current.

■ Adjustable Startup Time(AST)

Adjustable Startup Time (AST)

Start Fadeup Time s

Set driver's "Start Fade up Time". It means how much time the driver costs to achieve the "Module Current" that the user set. The valid value is 0s, 1s, 2s, 5s, 10s, 20s, 40s.

■ Fade Time(FT)

Fade Time(FT)

Fadeup Time s

Set driver's "Fade up time". This function is available in the Smart Midnight ClockDIM and Fixed ClockDIM mode; It means how much time the driver costs to achieve another dimming level from previous dimming level. The valid value is 0s, 1s, 2s, 5s, 10s, 20s, 40s.

■ 1-10V

Allow users to set the max and min output current and corresponding output voltage to clarify the 1-10V dimming curve. Input a 0~10V signal from 2nd pin of the dimming interface. Default: input $\leq 1V$, output current 10%; input $\geq 8.5V$, output current 100%.

Dimming Interface Selection(DIS)

1-10V PWM Smart Midnight ClockDIM Fixed ClockDIM No Dimming

1-10V Min dim level V %

1-10V Max dim level V %

■ PWM

Input a PWM signal from the 2nd pin(Dim+/Program) of the dimming interface to change the output current. User can set "Positive Logic" or "Negative Logic" of the PWM signal. PWM duty circle: 1%~99%(it has both positive and negative logics), frequency: 500Hz~5kHz, 3V~10V is high, 0.3V~0.8V is low.

Dimming Interface Selection(DIS)

1-10V PWM Smart Midnight ClockDIM Fixed ClockDIM No Dimming

PWM Logic(PWML)

Positive Or Negative Logic

■ Instruction

■ Smart Midnight ClockDIM

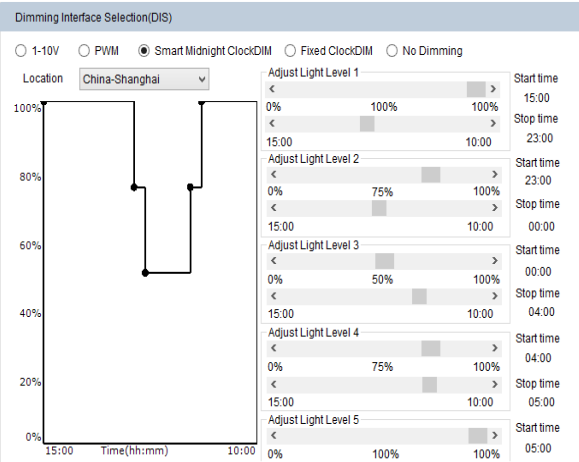

Smart Midnight ClockDIM allows dimming to predefined light levels based on the nightly operating time. With flexibility in setting time and light levels, the user can configure the driver for specific locations and application needs. Using Smart Midnight ClockDIM, it is possible to set up to 5 dim levels and time intervals. The driver does not have a real time clock. Instead it runs a virtual clock, determined by the length of nightly operating hours. A valid ON-time is defined as a period during which the driver operates continuously for ≥ 4 hours to ≤ 24 hours. For example, if the requirement in summer is: 23:00-00:00: 75%, 00:00-04:00: 50%, 04:00-05:00: 75% (other time 100% or Off). The driver should be powered on for 7h, so it can calculate the virtual clock time as 22:00. Then we can set the dimming plan: 22:00-23:00: 100%, 23:00-00:00: 75%, 00:00-04:00: 50%, 04:00-05:00: 75%. From summer to winter, the valid ON-time changes day by day. The driver should be powered on for 17h in winter, and it also can calculate the virtual clock time as 17:00. Then the dimming plan is 17:00-23:00: 100%, 23:00-00:00: 75%, 00:00-04:00: 50%, 04:00-05:00: 75%, 05:00-10:00: 100%. From the above, if we set the dimming plan as shown in the picture, after repeating the driver ON-time for 3 consecutive days, the dimming plan takes effect from the 4th day onwards. Each day the driver powered on, it has a different start time according to the virtual clock time. So the driver can satisfy different requirements for different seasons.

■ Constant Light Output(CLO)

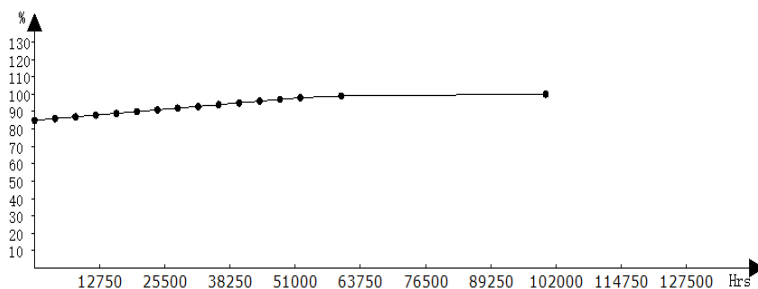
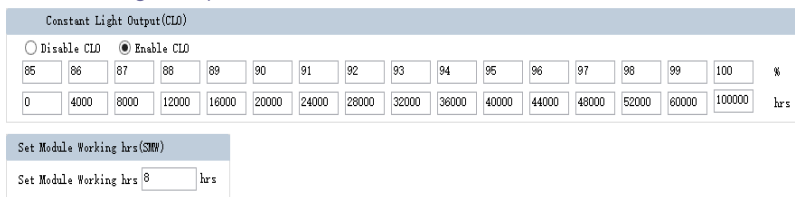

■ Fixed ClockDIM

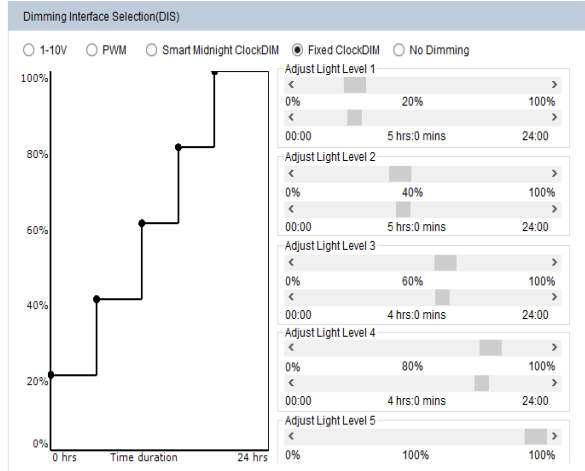

Allow users to separate 24hrs into 5 sections and corresponding output current.

■ No Dimming

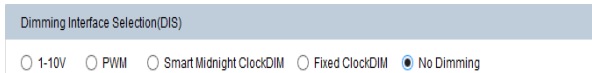

The driver will be in constant output mode.

■ Set Module Working hrs(SMW)

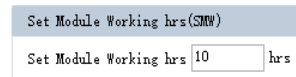

User can check how much time the driver works through this function.

Traditional light sources suffer from depreciation in light output over time. This applies to LED light sources as well. The CLO feature enables LED solutions to deliver constant lumen output through the life of the light engine. Based on the type of LEDs used, heat sinking and driver current, it is possible to estimate the depreciation of light output for specific LEDs and this information can be entered into the driver. The driver counts the number of light source working hours and will increase output current based on this input to enable CLO.

When the CLO feature is enabled, the driver nominal output current will be defined by the CLO percentage as shown by the equation below: $\text{Driver target nominal output current} = \text{CLO percentage} * \text{AOC}$. For example, in the CLO profile shown in Figure, between 52,000-60,000 working hours, the CLO percentage is set at 98%. Assuming the nominal AOC is set to 500mA, the driver output current with CLO enabled will be $0.98 * 500 = 600 \text{ mA}$.

The CLO percentage can be set to a value between 85%-100%, in increments of 1%. The LED module working hours can be set at any value between (0-100,000 hours).

■ Mechanical Specification

Dimensions (Unit: mm)

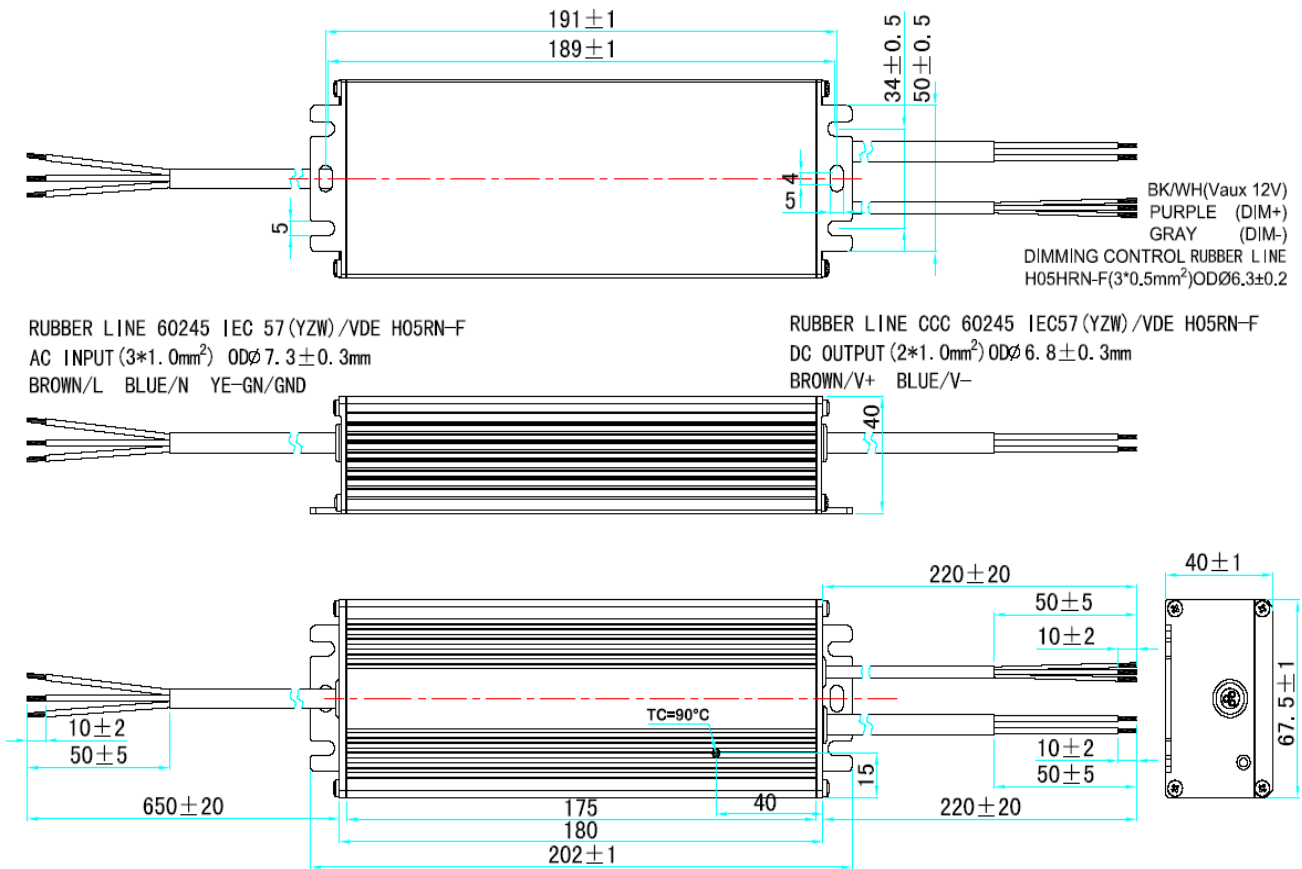

RoHS Compliance:

Our products comply with the European Directive 2002/95/EC, calling for the elimination of lead and other hazardous substances from electronic products.