

461118500056

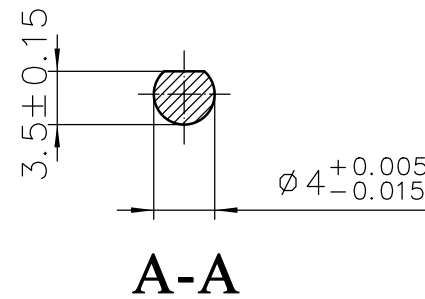
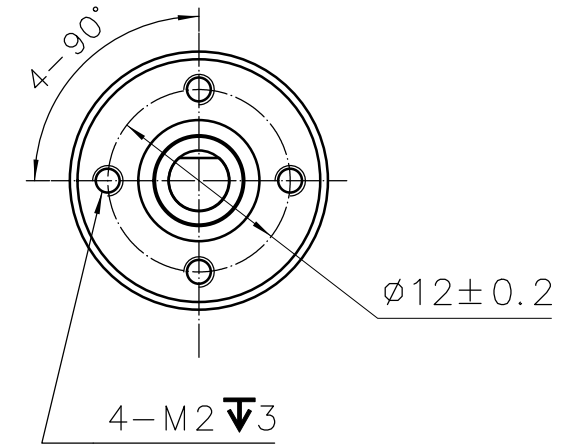
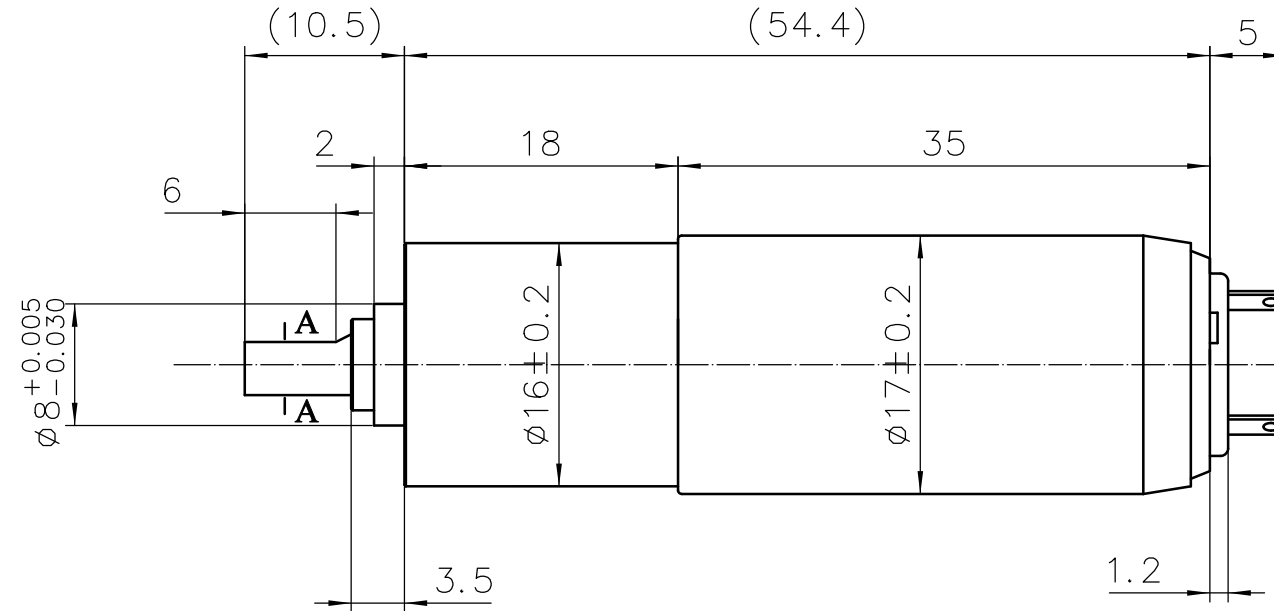
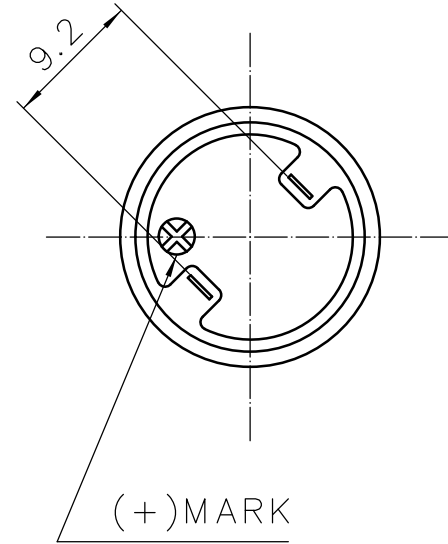

规格/Specification

额定电压/Nominal voltage	24	V
空载转速/No-load speed ($\pm 10\%$)	2902	rpm
空载电流/No-load current ($\pm 50\%$)	32.4	mA
额定转速/Nominal speed	2279	rpm
最大连续转矩/Max. continuous torque (motor thermal limit)	28	mNm
最大连续电流/Max. continuous current (motor thermal limit)	0.429	mA
堵转转矩/Stall torque	0.13	Nm
堵转电流/Stall current	1.90	A
环境温度范围/Ambient temperature	-20~+85	℃
重量/Weight	56.9	g
端电阻/Terminal resistance (motor) ($\pm 8\%$)	12.6	Ω
转矩常数/Torque constant (motor) ($\pm 8\%$)	19.49	mNm/A
转速常数/Speed constant (motor) ($\pm 8\%$)	490	rpm/V
转速/转矩斜率/Speed/torque gradient (motor)	317	rpm/mNm
电刷类型/Brushes type (motor)	Graphite brushes	
级数/Number of stages (gearhead)	1	
减速比/Reduction ratio (gearhead)	4.00:1	
效率/Efficiency (gearhead)	90%	

铭牌/Label Detail

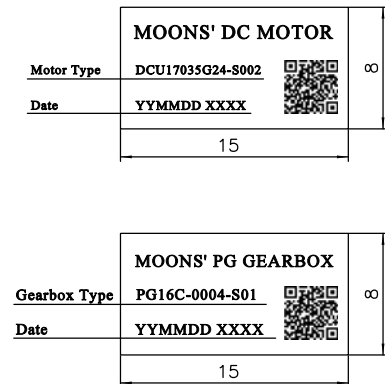

备注：二维码内包含电机名称和生产日期。

G		
F		
E		
D		
C		
B		
A	原始版本 Original revision	2018.11.03
REV.	版本记录 REVISION RECORD	DATE

Unit: mm
 第一角画法
 FIRST ANGLE METHOD
 未注线性与角度尺寸公差
 Tolerances for linear and angular dimensions without individual tolerance indications
 GB/T 1804-m eqv ISO 2768-1:m
 未注形状与位置尺寸公差
 Geometrical tolerance for features without individual tolerance indications
 GB/T 1184-K eqv ISO 2768-2:K

批准 Approve		
标准化 Standard		
工艺 Technology		
审核 Check		
设计 Design		

MOONS' Coreless Brushed DC Motor
 Shanghai Moons' Electric Co., Ltd.

This document is released for information only. Its reproduction in whole or in part or its dissemination to third parties is prohibited. All trademarks and registered trademarks appearing on this document are the property of their respective owners.