

Multilayer Chip Ferrite Bead – UPZ Series

Operating Temp. : -55°C~+125°C

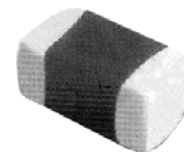

FEATURES

- Internal silver printed layers and magnetic shielded structures to minimize crosstalk
- Monolithic structure for excellent reliability
- Smaller DC resistance and larger allowable current than PZ series
- Can be used in a wide range of frequency to suppress EMI

APPLICATIONS

- Noise suppression for power lines or large current signal lines of electric equipments, Such as communication equipments, computers, A/V equipments, auto electronics, and etc

PRODUCT IDENTIFICATION

UPZ

1608

E

221

-2R2

T

F

①

②

③

④

⑤

⑥

⑦

①

Type	
UPZ	Chip Ferrite Bead For Ultra Large Current

②

External Dimensions (L×W) (mm)	
1005 [0402]	1.0×0.5
1608 [0603]	1.65×0.8
2012 [0805]	2.0×1.25

③

Material Code	
G, D, E, U	

④

Nominal Impedance	
Example	Nominal Value
300	30Ω
221	220Ω
102	1000Ω

⑤

Rated Current	
1R5	1.5A
2R2	2.2A

⑥

Packing	
T	Tape & Reel

⑦

Hazardous Substance Free Products	
F	

SHAPE AND DIMENSIONS

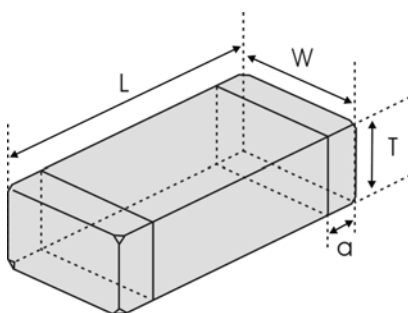

Unit: mm [inch]

Type	L	W	T	a
UPZ1005 [0402]	1.0±0.15 [.039±.006]	0.5±0.15 [.020±.006]	0.5±0.15 [.020±.006]	0.25±0.1 [.010±.004]
UPZ1608 [0603]	1.65±0.15 [.065±.006]	0.8±0.15 [.031±.006]	0.8±0.15 [.031±.006]	0.3±0.2 [.012±.008]
UPZ2012 [0805]	2.0 (+0.3, -0.1) [.079 (+.012, -.004)]	1.25±0.2 [.049±.008]	0.85±0.2 [.033±.008]	0.5±0.3 [.020±.012]

SPECIFICATIONS

UPZ1005 TYPE

Part Number	Impedance	Z Test Frequency	Max. DC Resistance	Max. Rated Current	Thickness
Units	Ω	MHz	m Ω	mA	mm [inch]
Symbol	Z	Freq.	DCR	I _r	T
UPZ1005D100-2R0TF	0~30	100	45	2000	0.5±0.15 [.020±.006]
UPZ1005D300-1R7TF	30±25%	100	50	1700	
UPZ1005D300-2R2TF	30±25%	100	35	2200	
UPZ1005D600-1R5TF	60±25%	100	75	1500	
UPZ1005D800-1R5TF	80±25%	100	70	1500	
UPZ1005D121-1R3TF	120±25%	100	90	1300	
UPZ1005D221-R90TF	220±25%	100	160	900	

UPZ1608 TYPE

Part Number	Impedance	Z Test Frequency	Max. DC Resistance	Max. Rated Current	Thickness
Units	Ω	MHz	m Ω	mA	mm [inch]
Symbol	Z	Freq.	DCR	I _r	T
UPZ1608G300-1R8TF	30±25%	100	60	1800	0.8±0.15 [.031±.006]
UPZ1608G600-1R2TF	60±25%	100	100	1200	
UPZ1608G101-1R0TF	100±25%	100	150	1000	
UPZ1608U220-6R0TF	22±25%	100	10	6000	
UPZ1608U280-6R0TF	28±25%	100	10	6000	
UPZ1608U700-4R0TF	70±25%	100	20	4000	
UPZ1608U221-2R2TF	220±25%	100	50	2200	
UPZ1608U331-1R5TF	330±25%	100	70	1500	
UPZ1608U391-1R5TF	390±25%	100	120	1500	
UPZ1608U471-1R5TF	470±25%	100	120	1500	
UPZ1608U601-1R3TF	600±25%	100	150	1300	
UPZ1608E300-5R0TF	30±25%	100	10	5000	
UPZ1608E600-3R5TF	60±25%	100	20	3500	
UPZ1608E101-3R0TF	100±25%	100	30	3000	
UPZ1608E181-2R2TF	180±25%	100	50	2200	
UPZ1608E221-2R2TF	220±25%	100	50	2200	
UPZ1608E331-1R7TF	330±25%	100	80	1700	
UPZ1608E601-1R0TF	600±25%	100	150	1000	
UPZ1608W260-6R0TF	26±25%	100	7	6000	

UPZ2012 TYPE

Part Number	Impedance	Z Test Frequency	Max. DC Resistance	Max. Rated Current	Thickness
Units	Ω	MHz	m Ω	mA	mm [inch]
Symbol	Z	Freq.	DCR	I _r	T
UPZ2012D220-6R0TF	22±25%	100	10	6000	0.85±0.2 [.033±.008]
UPZ2012D800-4R0TF	80±25%	100	20	4000	
UPZ2012U220-6R0TF	22±25%	100	10	6000	
UPZ2012U300-6R0TF	30±25%	100	10	6000	
UPZ2012U600-4R0TF	60±25%	100	20	4000	
UPZ2012U221-3R0TF	220±25%	100	40	3000	
UPZ2012E300-6R0TF	30±25%	100	10	6000	
UPZ2012E121-4R0TF	120±25%	100	20	4000	
UPZ2012E221-3R0TF	220±25%	100	40	3000	
UPZ2012E331-2R5TF	330±25%	100	50	2500	
UPZ2012E601-2R0TF	600±25%	100	90	2000	
UPZ2012E102-1R5TF	1000±25%	100	120	1500	



Specifications subject to change without notice. Please check our website for latest information. Revised 2017/04/15

Sunlord Industrial Park, Dafuyuan Industrial Zone, Guanlan, Shenzhen, China 518110 Tel: 0086-755-29832660 Fax: 0086-755-82269029 E-Mail: sunlord@sunlordinc.com

DETAIL ELECTRICAL CHARACTERISTICS

Rated Current

When operating temperatures exceed +85°C, derating of current is necessary for chip ferrite beads for which rated current is 1000mA and over. Please apply the derating curve shown in chart according to the operating temperature.

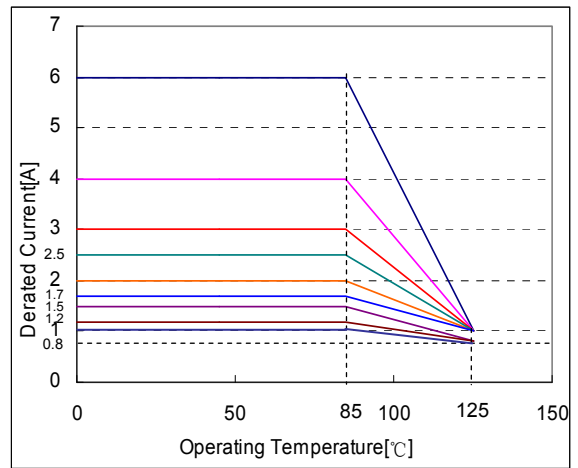

DETAIL ELECTRICAL CHARACTERISTICS

UPZ1005 Series

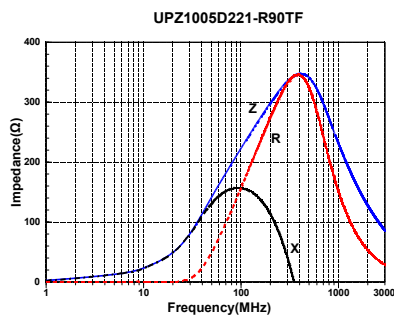
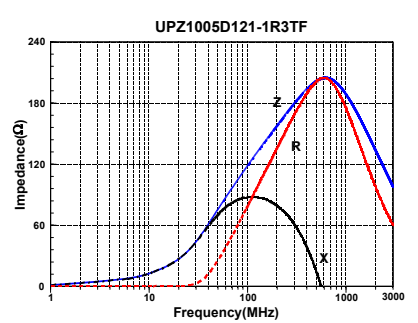
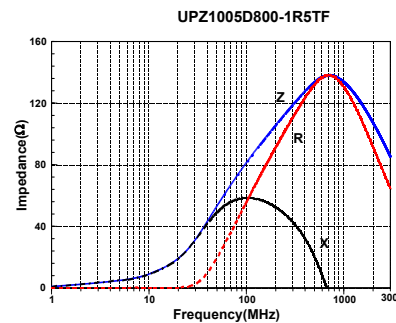
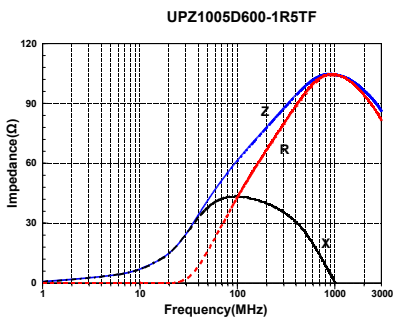
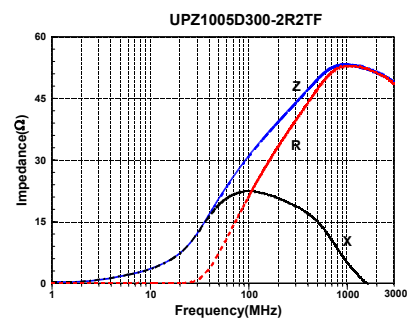
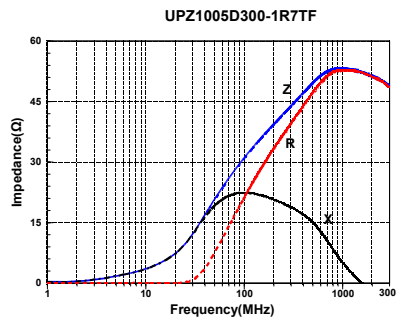
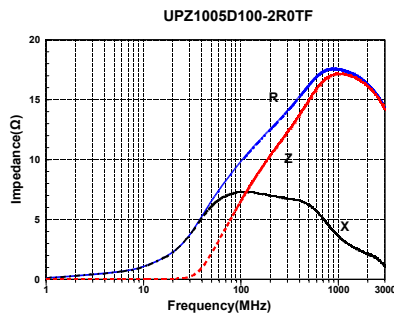

DETAIL ELECTRICAL CHARACTERISTICS

UPZ1608 TYPE

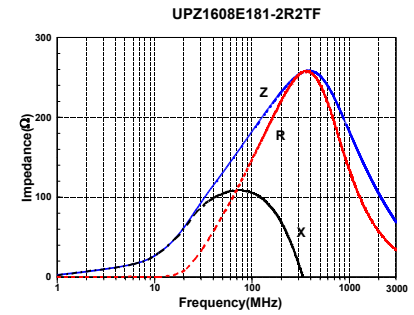
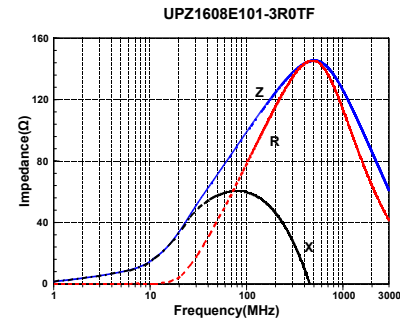
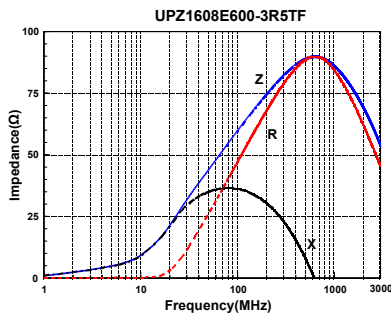
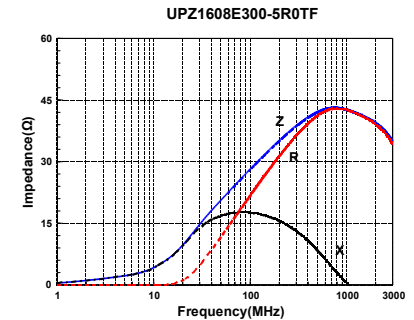
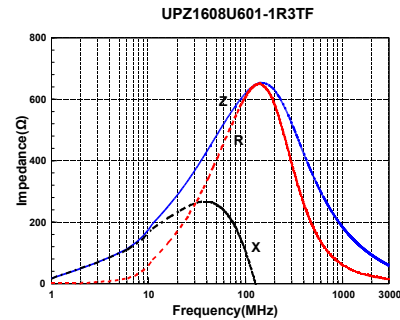
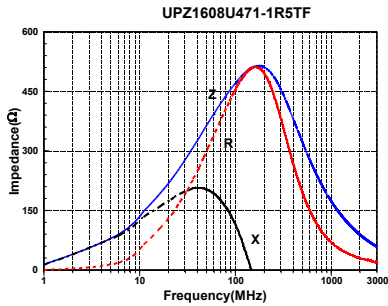
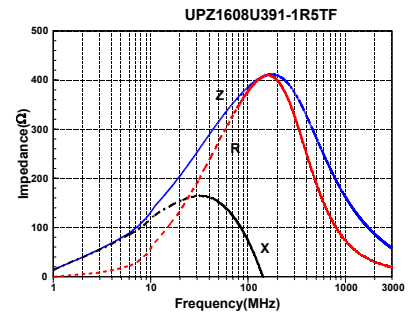
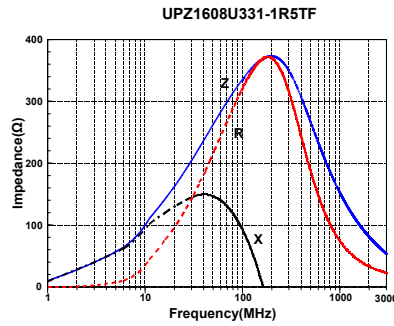
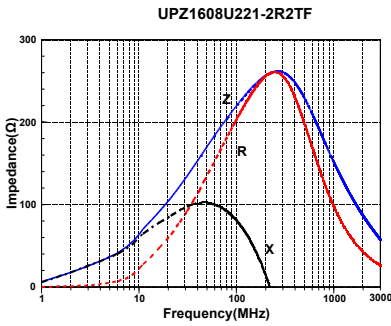
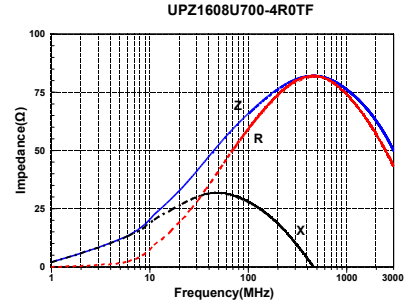
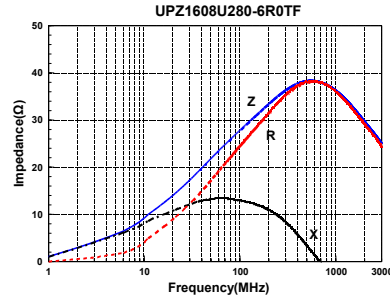
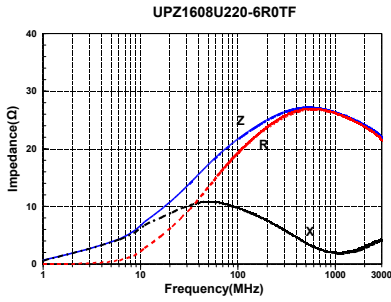
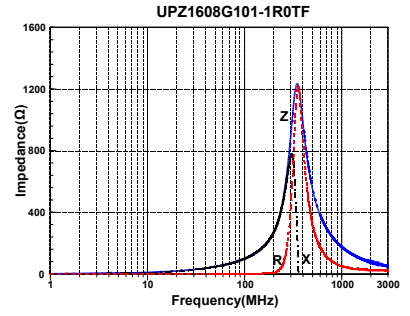
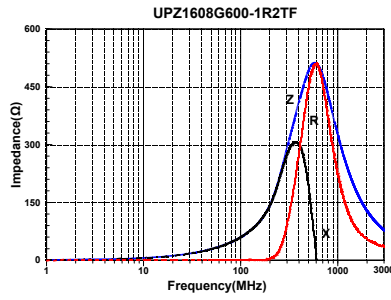
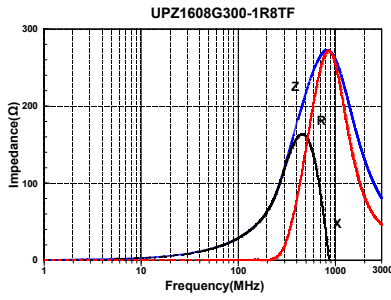

DETAIL ELECTRICAL CHARACTERISTICS

UPZ1608 TYPE

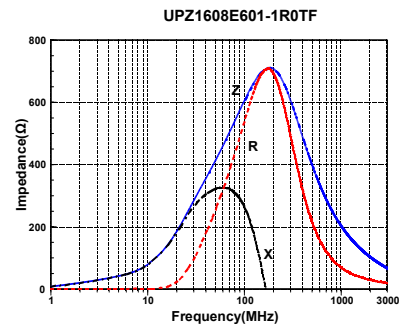
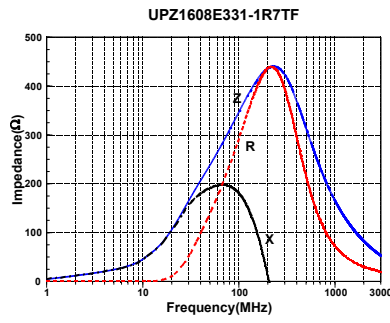
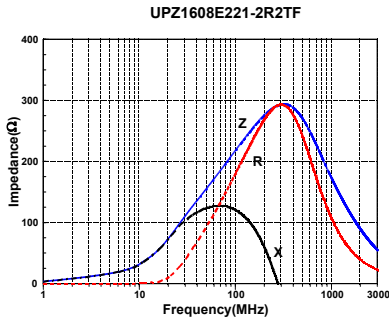

UPZ2012 TYPE

