

1- stage filter for 3-phase systems



See below:

Approvals and Compliances

Description

- 3 phase line filter with standard attenuation
- Available as high voltage filter (up to 520 VAC)

Applications

- Voltage rating 480 and 520 VAC for world wide acceptance
- Protection against interference voltage from the mains
- For photovoltaic systems and industrial applications
- Suitable for use in equipment according to IEC/UL 60950

References

We recommend for new applications the type [FMAC NEO](#)

Weblinks

[pdf data sheet](#), [html datasheet](#), [General Product Information](#), [Distributor-Stock-Check](#), [Detailed request for product](#), [Microsite](#)

Technical Data

Rated Current	6 - 1100A
Rated voltage	480/520 VAC, 50/60 Hz
Approval for	6 - 1100A @ Ta 40 (75) °C / 480 VAC; 50Hz
Overload Current	1.5 x Ir for 1 minute, per hour
Leakage Current	industrial < 15mA (440V / 50 Hz)
Dielectric Strength	480 VAC:
	2.25 kVDC between L-L
	3 kVDC between L-PE
	520 VAC:
	2.25 kVDC between L-L
	4 kVDC between L-PE
	Test voltage (2 sec)
Number of Filter Stages	1-stage
Weight	0.9 - 47 kg
Material: Housing	Metal
Sealing Compound	UL 94V-0

Mounting	Screw-on mounting on chassis, from top
Terminal	Screw clamps
Operating Temperature	-25 °C to 100 °C
Climatic Category	25/100/21 acc. to IEC 60068-1
Degree of Protection	IP20 acc. to IEC 60529
Protection Class	Suitable for appliances with protection class I acc. to IEC 61140
MTBF	> 200'000h acc. to MIL-HB-217 F

Approvals and Compliances



Detailed information on product approvals, code requirements, usage instructions and detailed test conditions can be looked up in [Details about Approvals](#)

SCHURTER products are designed for use in industrial environments. They have approvals from independent testing bodies according to national and international standards. Products with specific characteristics and requirements such as required in the automotive sector according to IATF 16949, medical technology according to ISO 13485 or in the aerospace industry can be offered exclusively with customer-specific, individual agreements by SCHURTER.

Approvals



The approval mark is used by the testing authorities to certify compliance with the safety requirements placed on electronic products.

Approval Reference Type: FMAC

Approval Logo	Certificates	Certification Body	Description
	VDE Approvals	VDE	Certificate Number: 40004666 + 40004673
	UL Approvals	UL	UL File Number: E72928

Product standards

Product standards that are referenced

Organization	Design	Standard	Description
	Designed according to	IEC 60939	Passive filters for suppressing electromagnetic interference
	Designed according to	UL 1283	Electromagnetic interference filters





Application standards

Application standards where the product can be used

Organization	Design	Standard	Description
	Designed for applications acc.	IEC/UL 60950	IEC 60950-1 includes the basic requirements for the safety of information technology equipment.

Compliances

The product complies with following Guide Lines

Identification	Details	Initiator	Description
	CE declaration of conformity	SCHURTER AG	The CE marking declares that the product complies with the applicable requirements laid down in the harmonisation of Community legislation on its affixing in accordance with EU Regulation 765/2008.
	RoHS	SCHURTER AG	Directive RoHS 2011/65/EU, Amendment (EU) 2015/836
	China RoHS	SCHURTER AG	The law SJ / T 11363-2006 (China RoHS) has been in force since 1 March 2007. It is similar to the EU directive RoHS.
	REACH	SCHURTER AG	On 1 June 2007, Regulation (EC) No 1907/2006 on the Registration, Evaluation, Authorization and Restriction of Chemicals 1 (abbreviated as "REACH") entered into force.

Dimension [mm]

Case 24-3

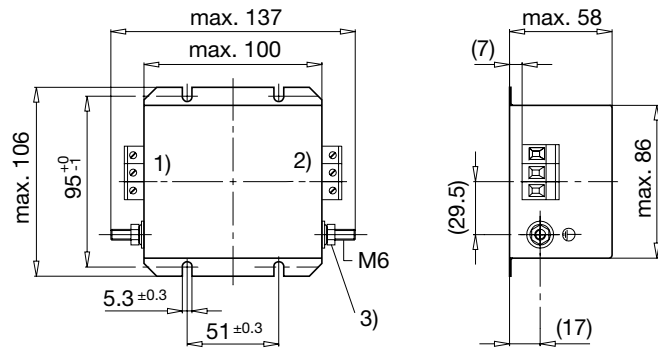

- 1) Line
- 2) Load
- 3) Nut torque 3...4 Nm

Case 31-3

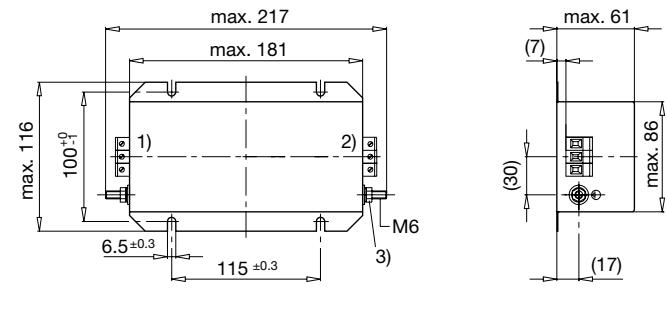

Case 32-7

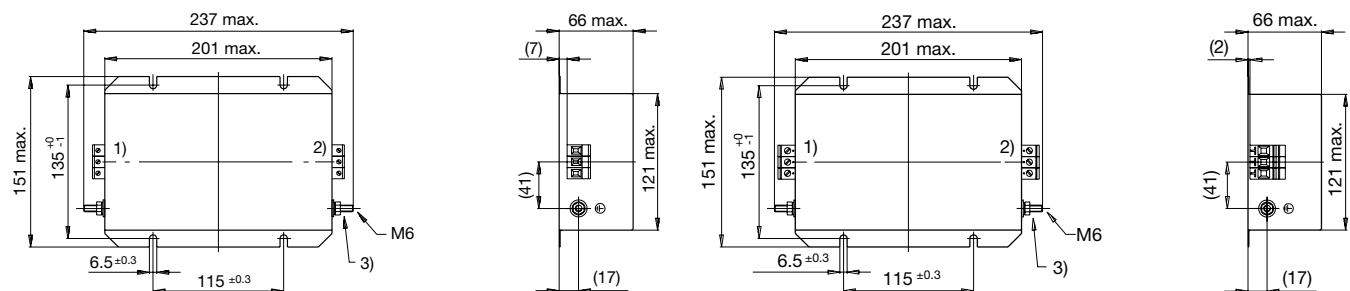

Case 32-C

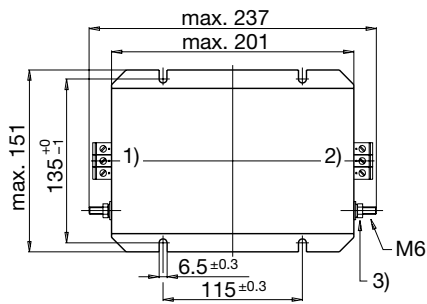

Case 34-3

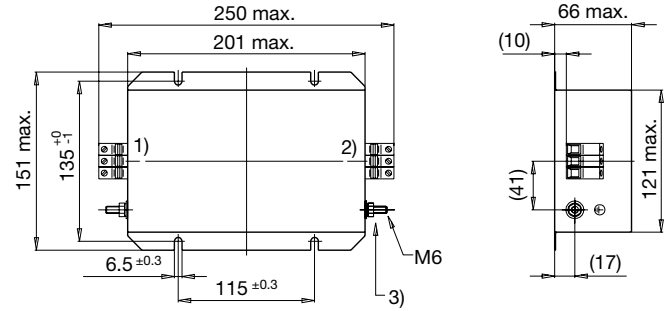

Case 34-C

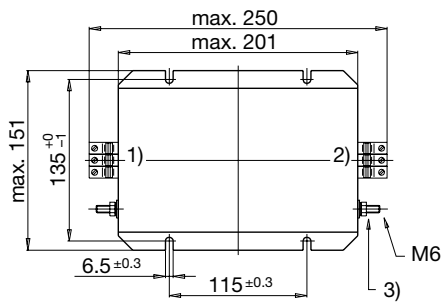

Case 37-3

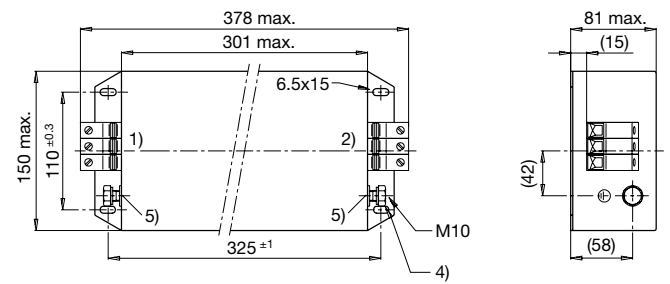

Case 53-3

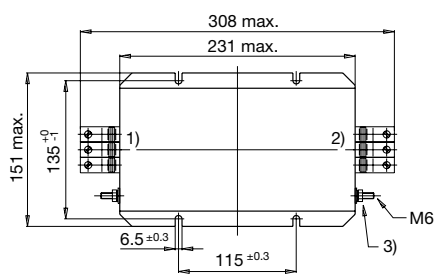

Case 54-3

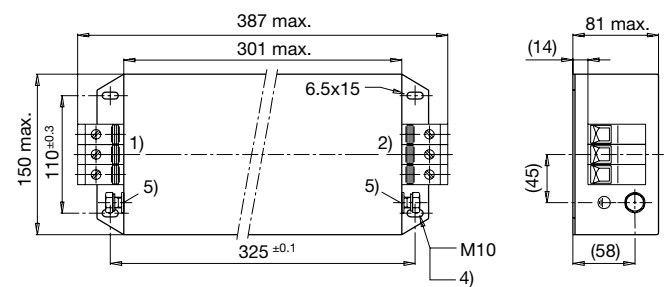

- 1) Line
- 2) Load
- 3) Tightening torque 3...4 Nm
- 4) Tightening torque 10...17 Nm
- 5) Do not unscrew lock-nut

Case 55-3

Case 56-3

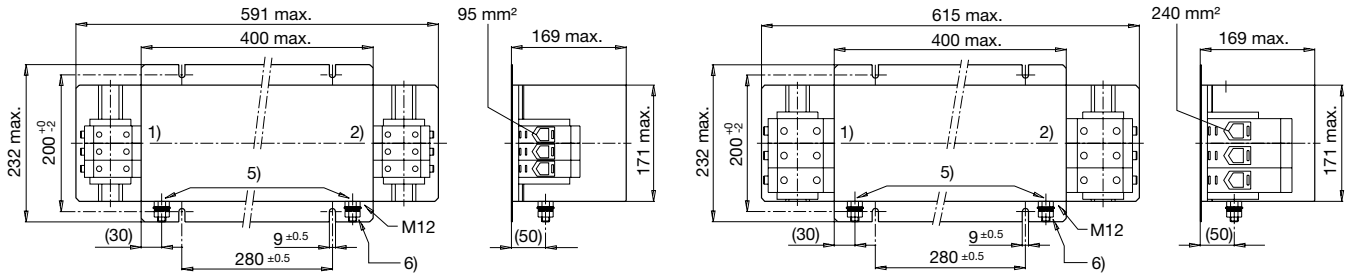

Case 57

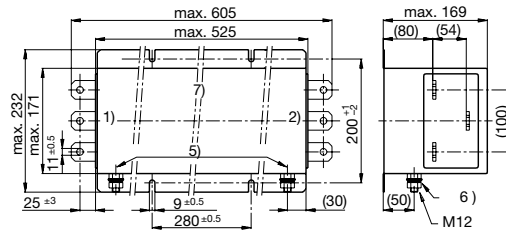

Case 74

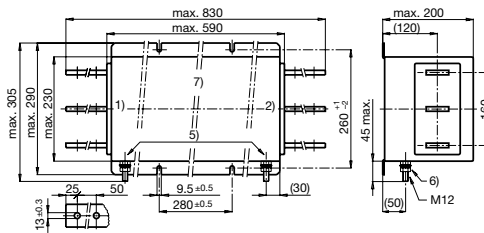

- 1) Line
- 2) Load
- 5) Do not unscrew lock-nut
- 6) Tightening torque 14...30 Nm
- 7) Current plates 720 mm² (60x12)

Technical data to the filter components

Rated Current @ Tu 40°C (75°C) [A]	Characteristic	Rated Voltage [VAC]	L [mH]	C1 [µF]	C2 [µF]	C3 [nF]	C4 [nF]	C5 [µF]	C6 [µF]	R1 [MΩ]	R2 [MΩ]	R3 [MΩ]	R4 [MΩ]
6 (6)	Excellent attenuation	480	10	1.0	-	100	10	2.2	-	-	-	1	1
8 (5)	Excellent attenuation	480	10	1.0	-	100	10	2.2	-	-	-	1	1
16 (10)	Excellent attenuation	480	6	1.0	-	100	10	2.2	-	-	-	1	1
16 (Pending)	High voltage filter	520	6	1.5	-	50	11	1.5	-	2	1	1	2
16 (10)	Excellent attenuation	480	6	1.0	-	100	10	2.2	-	-	-	1	1
25 (15)	Excellent attenuation	480	3	4.4	1	10	47	4.4	1	2.2	1	1	2.2
25 (14)	High attenuation	480	2.4	4.4	1	10	47	4.4	1	2.2	-	1	2
25 (Pending)	High voltage filter	520	3	3	1.1	50	11	3	1.1	2	1	1	2
36 (20)	High attenuation	480	1.5	4.4	1	10	47	4.4	1	2.2	-	1	2
36 (Pending)	High voltage filter	520	2	3	1.1	50	11	3	1.1	2	1	1	2
50 (32)	Excellent attenuation	480	1	4.4	1	10	100	4.4	1	2.2	1	1	2.2
50 (30)	High attenuation	480	1	4.4	1	10	100	4.4	1	2.2	-	1	2
50 (Pending)	High voltage filter	520	1	3	1.1	50	11	3	1.1	2	1	1	2
64 (37)	High attenuation	480	0.6	4.4	1	10	100	4.4	1	2.2	-	1	2
80 (45)	Excellent attenuation	480	1	6.6	1	47	100	6.6	1	2.2	1	1	2.2
80 (Pending)	High voltage filter	520	1	4.5	1.1	50	50	4.5	1.1	2	1	1	2

Rated Current @ Tu 40°C (75°C) [A]	Characteristic	Rated Voltage [VAC]	L [mH]	C1 [μF]	C2 [μF]	C3 [nF]	C4 [nF]	C5 [μF]	C6 [μF]	R1 [MΩ]	R2 [MΩ]	R3 [MΩ]	R4 [MΩ]
64 (37)	Excellent attenuation	480	0.6	4.4	1	10	100	4.4	1	2.2	1	1	2.2
64 (Pending)	High voltage filter	520	0.6	3	1.1	50	11	3	1.1	2	1	1	2
110 (70)	Excellent attenuation	480	0.7	6.6	1	47	100	6.6	1	2.2	1	1	2.2
110 (Pending)	High voltage filter	520	0.7	4.5	1.1	50	50	4.5	1.1	2	1	1	2
180 (Pending)	Excellent attenuation	480	0.4	6.6	1	47	100	6.6	1	2.2	1	1	2.2
180 (Pending)	High voltage filter	520	0.4	4.5	1.1	50	50	4.5	1.1	2	1	1	2
250 (Pending)	Excellent attenuation	480	0.3	11	1	100	100	11	1	2.2	0.5	0.5	2.2
250 (Pending)	High voltage filter	520	0.3	7.5	1.1	50	50	7.5	1.1	2	1	1	2
340 (Pending)	Excellent attenuation	480	0.2	11	1	100	100	22	1	2.2	0.33	0.33	2.2
340 (Pending)	High voltage filter	520	0.2	7.5	1.1	50	50	15	1.1	2	1	1	2
450 (Pending)	Excellent attenuation	480	0.2	11	1	100	100	22	1	2.2	0.33	0.33	2.2
550 (Pending)	Excellent attenuation	480	0.2	11	1	100	100	22	1	2.2	0.33	0.33	2.2
1100 (Pending)	High voltage filter	520	0.12	11	1.1	50	-	22	1.1	2	0.5	0.25	2

Diagrams

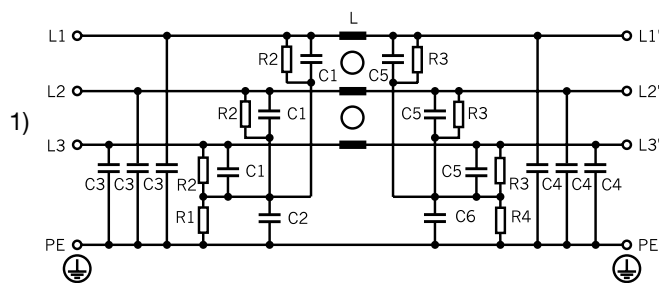

1) Line

Derating Curves

Permissible Working Current as a Function of Ambient Temperature

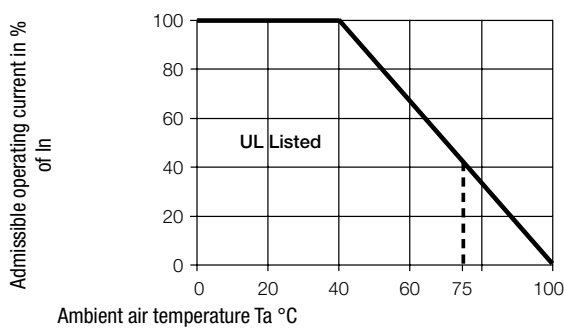

Attenuation Loss

--- 50Ω differential mode ___ 50Ω common mode

Industrial version

6A (FMAC-0924-0610)

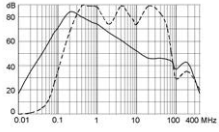

8A (FMAC-0931-0810)

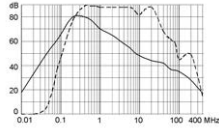

16A (FMAC-0931-1610)
16A (FMAC-0932-1610)

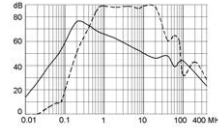

16A (FMAC-0931-1612I)

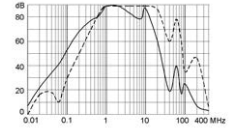

25A (FMAC-0932-2510)

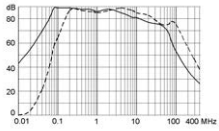

25A (FMAC-0932-2510L)

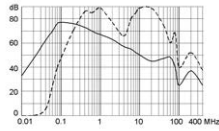

25A (FMAC-0932-2512I)

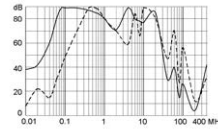

36A (FMAC-0934-3610)

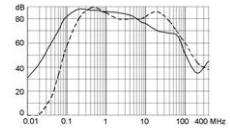

36A (FMAC-0932-3610L)

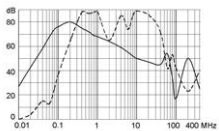

36A (FMAC-0932-3612I)

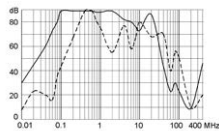

50A (FMAC-0934-5010)

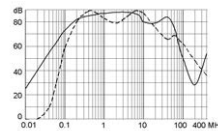

50A (FMAC-0934-5010L)

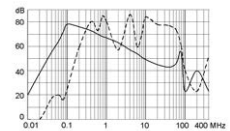

50A (FMAC-0934-5012I)

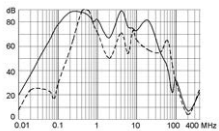

64A (FMAC-0953-6410)

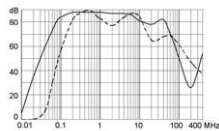

64A (FMAC-0934-6410L)

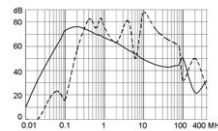

64A (FMAC-0953-6412I)

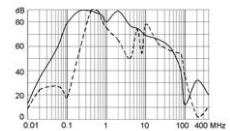

80A (FMAC-0937-8010)

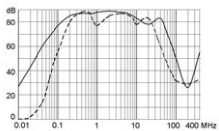

80A (FMAC-0937-8012I)

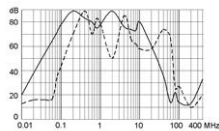

110A (FMAC-0954-H110)

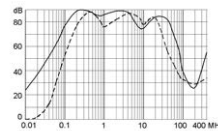

110A (FMAC-0954-H112I)

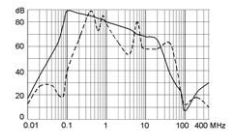

180A (FMAC-0955-H210)

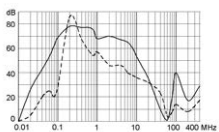

180A (FMAC-0955-H212I)

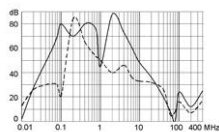

250A (FMAC-0956-H310)

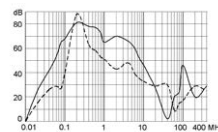

250A (FMAC-0956-H312I)

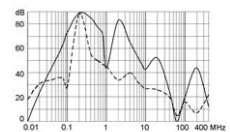

340A (FMAC-0956-H410)

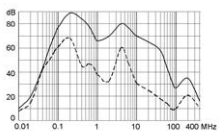

340A (FMAC-0956-H412I)

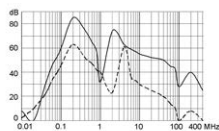

450A (FMAC-0957-H550)

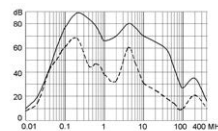

550A (FMAC-0957-H650)

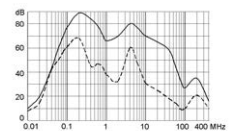

1100A (FMAC-0974-K152I)

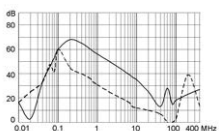

All Variants

Rated Current @ Tu 40°C (75°C) [A]	Characteristic	Rated Voltage [VAC]	Tripped Power Dissipation [W]	Leakage Current [mA] @ 440V,	Contact Resistance [mΩ]	Weight [kg]	Screw clamps [mm ²] 2)	Housings	Order Number
6 (6)	Excellent attenuation	480	2.48	1.3	23	0.9 kg	4	24-3	FMAC-0924-0610
8 (5)	Excellent attenuation	480	5.38	1.3	28	1.8 kg	4	31-3	FMAC-0931-0810
16 (10)	Excellent attenuation	480	8.83	1.3	11.5	1.8 kg	4	31-3	FMAC-0931-1610
16 (Pending)	High voltage filter	520	8.83	0.7	11.5	1.8 kg	4	31-3	FMAC-0931-1612I
16 (10)	Excellent attenuation	480	8.83	1.3	11.5	2.8 kg	4	32-3	FMAC-0932-1610
25 (15)	Excellent attenuation	480	8.25	8.4	4.4	3.4 kg	6	32-7	FMAC-0932-2510
25 (14)	High attenuation	480	9.86	8.4	5.26	3.5 kg	4	32-7	FMAC-0932-2510L
25 (Pending)	High voltage filter	520	8.25	8.6	4.4	3.35 kg	6	32-7	FMAC-0932-2512I
36 (20)	High attenuation	480	10.55	8.4	2.71	3.75 kg	6	32-C	FMAC-0932-3610L
36 (20)	Excellent attenuation	480	12.91	8.6	3.32	3.5 kg	6	34-3	FMAC-0934-3610
36 (Pending)	High voltage filter	520	12.91	8.6	3.32	3.3 kg	6	34-3	FMAC-0934-3612I
50 (32)	Excellent attenuation	480	9.75	9.0	1.3	3.4 kg	6	34-3	FMAC-0934-5010
50 (30)	High attenuation	480	12.63	9.0	1.68	3.6 kg	6	34-C	FMAC-0934-5010L
50 (Pending)	High voltage filter	520	9.75	9.0	1.3	3.35 kg	6	34-3	FMAC-0934-5012I
64 (37)	High attenuation	480	18.23	8.6	1.48	4.2 kg	6	34-C	FMAC-0934-6410L
80 (45)	Excellent attenuation	480	22.6	9.7	1.17	7 kg	25	37-3	FMAC-0937-8010
80 (Pending)	High voltage filter	520	22.6	9.7	1.17	7.28 kg	25	37-3	FMAC-0937-8012I
64 (37)	Excellent attenuation	480	13.52	9.0	1.1	3.9 kg	25	53-3	FMAC-0953-6410
64 (Pending)	High voltage filter	520	13.52	9.0	1.1	3.8 kg	25	53-3	FMAC-0953-6412I
110 (70)	Excellent attenuation	480	27.23	9.7	0.75	7.5 kg	50	54-3	FMAC-0954-H110
110 (Pending)	High voltage filter	520	27.23	9.7	0.75	7.45 kg	50	54-3	FMAC-0954-H112I
180 (Pending)	Excellent attenuation	480	36	9.7	0.37	22 kg	95	55-3	FMAC-0955-H210
180 (Pending)	High voltage filter	520	36	9.7	0.37	23 kg	95	55-3	FMAC-0955-H212I
250 (Pending)	Excellent attenuation	480	36	10.5	0.2	23.7 kg	240	56-3	FMAC-0956-H310
250 (Pending)	High voltage filter	520	36	9.1	0.2	25 kg	240	56-3	FMAC-0956-H312I
340 (Pending)	Excellent attenuation	480	45	10.5	0.13	27 kg	240	56-3	FMAC-0956-H410
340 (Pending)	High voltage filter	520	45	5.6	0.13	30 kg	240	56-3	FMAC-0956-H412I
450 (Pending)	Excellent attenuation	480	40	10.5	0.06	33 kg	(B)	57	FMAC-0957-H550
550 (Pending)	Excellent attenuation	480	45	10.5	0.046	32 kg	(B)	57	FMAC-0957-H650
1100 (Pending)	High voltage filter	520	80	9.5	0.022	47 kg	(A)	74	FMAC-0974-K152I

Most Popular.

Availability for all products can be searched real-time: <https://www.schurter.com/en/Stock-Check/Stock-Check-SCHURTER>

6A version: packing unit 2 pcs.

(A): Connecting straps for M12

(B): Connecting straps for M10

1) Nominal leakage current acc. to IEC60950 - 5.2.5. under normal operating conditions. Note: worst case leakage current acc. to IEC60950 - Annex G4 (situation with two interrupted lines) can be much higher.

2) Maximum conductor cross section (wire gauge) to be used; a comparative table for AWG and mm² values can be found in the general product information <https://www.schurter.com/en/FAQ#10>

Packaging unit 1 Pcs