

TPS6107x 90% Efficient Synchronous Boost Converter With 600-mA Switch

1 Features

- 90% Efficient Synchronous Boost Converter
 - 75-mA Output Current at 3.3 V From 0.9-V Input
 - 150-mA Output Current at 3.3 V From 1.8-V Input
- Device Quiescent Current: 19 μ A (Typ)
- Input Voltage Range: 0.9 V to 5.5 V
- Adjustable Output Voltage Up to 5.5 V
- Power-Save Mode Version Available for Improved Efficiency at Low Output Power
- Load Disconnect During Shutdown
- Overtemperature Protection
- Small 6-Pin Thin SOT23 Package

2 Applications

- All One-Cell, Two-Cell, and Three-Cell Alkaline, NiCd or NiMH or Single-Cell Li Battery-Powered Products
- Portable Audio Players
- PDAs
- Cellular Phones
- Personal Medical Products
- White LED Lighting

3 Description

The TPS6107x devices provide a power supply solution for products powered by either a one-cell, two-cell, or three-cell alkaline, NiCd or NiMH, or one-cell Li-ion or Li-polymer battery. Output currents can go as high as 75 mA while using a single-cell alkaline, and discharge it down to 0.9 V. It can also be used for generating 5 V at 200 mA from a 3.3-V rail or a Li-ion battery. The boost converter is based on a fixed frequency, pulse-width-modulation (PWM) controller using a synchronous rectifier to obtain maximum efficiency. At low load currents the TPS61070 and TPS61073 enter the power-save mode to maintain a high efficiency over a wide load current range. The power-save mode is disabled in the TPS61071 and TPS61072, forcing the converters to operate at a fixed switching frequency. The maximum peak current in the boost switch is typically limited to a value of 600 mA.

The TPS6107x output voltage is programmed by an external resistor divider. The converter can be disabled to minimize battery drain. During shutdown, the load is completely disconnected from the battery. The device is packaged in a 6-pin thin SOT23 package (DDC).

Device Information⁽¹⁾

PART NUMBER	PACKAGE	BODY SIZE (NOM)
TPS61070	SOT (6)	2.90 mm x 1.60 mm
TPS61071		
TPS61072		
TPS61073		

(1) For all available packages, see the orderable addendum at the end of the datasheet.

4 Typical Application Circuit

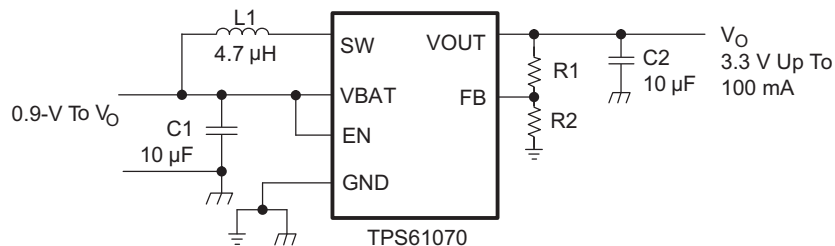

Table of Contents

1	Features	1	10.3	Feature Description.....	9
2	Applications	1	10.4	Device Functional Modes.....	11
3	Description	1	11	Application and Implementation	12
4	Typical Application Circuit	1	11.1	Application Information.....	12
5	Revision History	2	11.2	Typical Application	12
6	Device Comparison Table	3	11.3	System Examples	17
7	Pin Configuration and Functions	3	12	Power Supply Recommendations	19
8	Specifications	4	13	Layout	19
8.1	Absolute Maximum Ratings	4	13.1	Layout Guidelines	19
8.2	ESD Ratings.....	4	13.2	Layout Example	19
8.3	Recommended Operating Conditions.....	4	13.3	Thermal Considerations	20
8.4	Thermal Information	4	14	Device and Documentation Support	21
8.5	Electrical Characteristics.....	5	14.1	Device Support.....	21
8.6	Typical Characteristics	6	14.2	Related Links	21
9	Parameter Measurement Information	8	14.3	Trademarks	21
10	Detailed Description	9	14.4	Electrostatic Discharge Caution.....	21
10.1	Overview	9	14.5	Glossary	21
10.2	Functional Block Diagram	9	15	Mechanical, Packaging, and Orderable Information	21

5 Revision History

Changes from Revision D (December 2014) to Revision E

Page

- Changed the *Device Options Table* To: [Device Comparison Table](#) and included the Part Number column **3**

Changes from Revision C (March 2009) to Revision D

Page

- Added *ESD Ratings* table, *Feature Description* section, *Device Functional Modes*, *Application and Implementation* section, *Power Supply Recommendations* section, *Layout* section, *Device and Documentation Support* section, and *Mechanical, Packaging, and Orderable Information* section **1**

6 Device Comparison Table

PART NUMBER	OUTPUT VOLTAGE DC/DC	POWER-SAVE MODE	OPERATING FREQUENCY	EN THRESHOLD REFERENCE VOLTAGE
TPS61070DDC	Adjustable	Enabled	1200 kHz	VBAT
TPS61071DDC	Adjustable	Disabled	1200 kHz	VBAT
TPS61072DDC	Adjustable	Disabled	600 kHz	VBAT
TPS61073DDC	Adjustable	Enabled	1200 kHz	1.8 V Logic

7 Pin Configuration and Functions

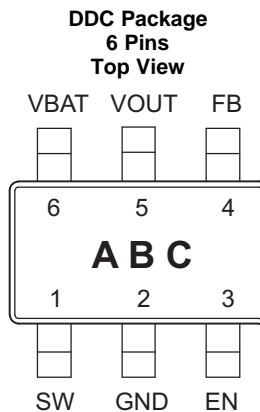

Pin Functions

PIN		I/O	DESCRIPTION
NAME	NO.		
EN	3	I	Enable input (1/VBAT enabled, 0/GND disabled)
FB	4	I	Voltage feedback for programming the output voltage
GND	2	—	IC ground connection for logic and power
SW	1	I	Boost and rectifying switch input
VBAT	6	I	Supply voltage
VOUT	5	O	Boost converter output

8 Specifications

8.1 Absolute Maximum Ratings

over operating free-air temperature range (unless otherwise noted)⁽¹⁾

	MIN	MAX	UNIT
Input voltage on SW, VOUT, VBAT, EN, FB	-0.3	7	V
Operating virtual junction temperature, T _J	-40	150	°C
Storage temperature, T _{stg}	-65	150	°C

- (1) Stresses beyond those listed under *Absolute Maximum Ratings* may cause permanent damage to the device. These are stress ratings only, and functional operation of the device at these or any other conditions beyond those indicated under *Recommended Operating Conditions* is not implied. Exposure to absolute-maximum-rated conditions for extended periods may affect device reliability.

8.2 ESD Ratings

		VALUE	UNIT
V _(ESD)	Electrostatic discharge	Human-body model (HBM), per ANSI/ESDA/JEDEC JS-001 ⁽¹⁾	±2000
		Charged-device model (CDM), per JEDEC specification JESD22-C101 ⁽²⁾	±750

- (1) JEDEC document JEP155 states that 500-V HBM allows safe manufacturing with a standard ESD control process. Manufacturing with less than 500-V HBM is possible with the necessary precautions.
 (2) JEDEC document JEP157 states that 250-V CDM allows safe manufacturing with a standard ESD control process. Manufacturing with less than 250-V CDM is possible with the necessary precautions.

8.3 Recommended Operating Conditions

	MIN	NOM	MAX	UNIT
Supply voltage at VBAT, V _I (TPS61070, TPS61071, TPS61072)	0.9		5.5	V
Supply voltage at VBAT, V _I (TPS61073)	2.3		5.5	V
Operating free air temperature range, T _A	-40		85	°C
Operating virtual junction temperature range, T _J	-40		125	°C

8.4 Thermal Information

THERMAL METRIC ⁽¹⁾		TPS6107x	UNIT
		DDC	
		6 PINS	
R _{θJA}	Junction-to-ambient thermal resistance	139.1	°C/W
R _{θJC(top)}	Junction-to-case (top) thermal resistance	34.8	
R _{θJB}	Junction-to-board thermal resistance	42.5	
Ψ _{JT}	Junction-to-top characterization parameter	1.4	
Ψ _{JB}	Junction-to-board characterization parameter	40.7	
R _{θJC(bot)}	Junction-to-case (bottom) thermal resistance	n/a	

- (1) For more information about traditional and new thermal metrics, see the *IC Package Thermal Metrics* application report, [SPRA953](#).

8.5 Electrical Characteristics

over recommended free-air temperature range and over recommended input voltage range (typical at an ambient temperature range of 25°C) (unless otherwise noted)

PARAMETER		TEST CONDITIONS	MIN	TYP	MAX	UNIT	
DC/DC STAGE							
V _I	Minimum input voltage range for start-up (TPS61070, TPS61071, TPS61072)	R _L = 270 Ω		1.1	1.2	V	
	Minimum input voltage range for start-up (TPS61073)	R _L = 270 Ω			2.3		
	Input voltage range, after start-up (TPS61070, TPS61071, TPS61072)	T _A = 25°C	0.9		5.5		
	Input voltage range, after start-up (TPS61073)		2.3		5.5		
V _O	Output voltage range (TPS61070, TPS61071, TPS61072)		1.8		5.5	V	
	Output voltage range (TPS61073)		2.3		5.5		
V _(FB)	Feedback voltage		495	500	505	mV	
f	Oscillator frequency (TPS61070, TPS61071, TPS61073)		960	1200	1440	kHz	
	Oscillator frequency (TPS61072)		480	600	720		
I _(SW)	Switch current limit	V _{OUT} = 3.3 V	500	600	700	mA	
	Start-up current limit			0.5 × I _{SW}			
	Boost switch-on resistance	V _{OUT} = 3.3 V		480		mΩ	
	Rectifying switch-on resistance	V _{OUT} = 3.3 V		600		mΩ	
	Total accuracy (including line and load regulation)				3%		
	Line regulation				1%		
	Load regulation				1%		
	Quiescent current (TPS61070, TPS61071, TPS61072)	VBAT	I _O = 0 mA, V _(EN) = V _{BAT} = 1.2 V, V _{OUT} = 3.3 V, T _A = 25°C		0.5	1	μA
		V _{OUT}			19	30	μA
	Quiescent current (TPS61073)	VBAT	I _O = 0 mA, V _(EN) = 1.8 V, V _{BAT} = 2.4 V, V _{OUT} = 5 V, T _A = 25°C		1	1.5	μA
		V _{OUT}			30	50	μA
	Shutdown current (TPS61070, TPS61071, TPS61072)	V _(EN) = 0 V, V _{BAT} = 1.2 V, T _A = 25°C		0.05	0.5	μA	
	Shutdown current (TPS61073)	V _(EN) = 0 V, V _{BAT} = 3.6 V, T _A = 25°C		0.05	1.5	μA	
CONTROL STAGE							
V _(UVLO)	Undervoltage lockout threshold	V _(BAT) voltage decreasing		0.8		V	
V _{IL}	EN input low voltage (TPS61070, TPS61071, TPS61072)				0.2 × V _{BAT}	V	
	EN input low voltage (TPS61073)				0.4		
V _{IH}	EN input high voltage (TPS61070, TPS61071, TPS61072)		0.8 × V _{BAT}			V	
	EN input high voltage (TPS61073)		1.2				
	EN input current (TPS61070, TPS61071, TPS61072)	Clamped on GND or V _{BAT}		0.01	0.1	μA	
	EN input current (TPS61073)	Clamped on GND or V _{BAT}		0.01	0.3	μA	
	Overtemperature protection			140		°C	
	Overtemperature hysteresis			20		°C	

8.6 Typical Characteristics

8.6.1 Table of Graphs

		FIGURE
Maximum output current	vs Input voltage	Figure 1
Efficiency	vs Output current	Figure 2
	vs Output current	Figure 3
	vs Output current	Figure 4
	vs Input voltage	Figure 5
	vs Input voltage	Figure 6
Output voltage	vs Output current	Figure 7
	vs Output current	Figure 8
No load supply current into VOUT	vs Input voltage	Figure 9

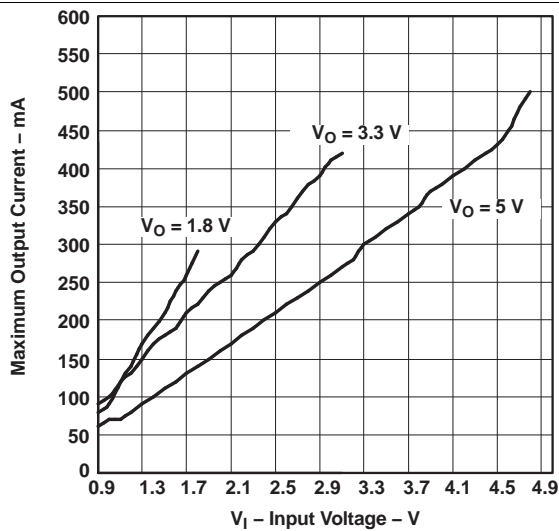

Figure 1. Maximum Output Current vs Input Voltage

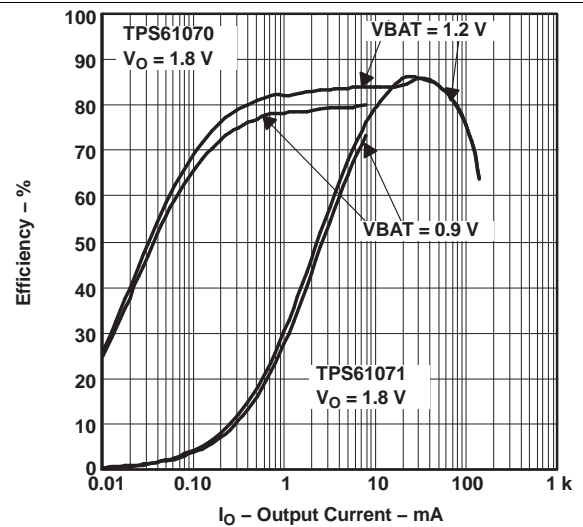

Figure 2. Efficiency vs Output Current

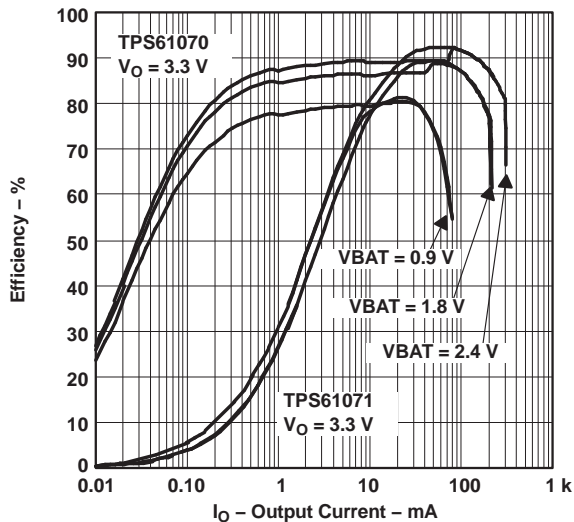

Figure 3. Efficiency vs Output Current

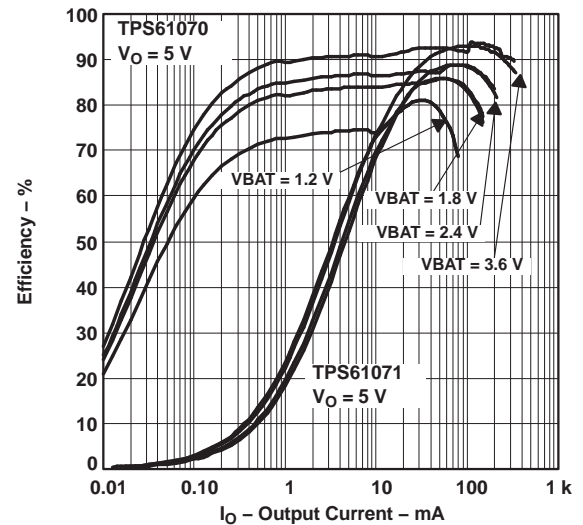

Figure 4. Efficiency vs Output Current

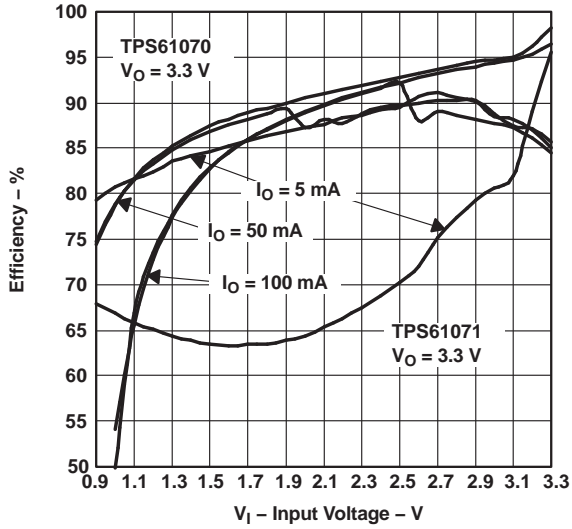

Figure 5. Efficiency vs Input Voltage

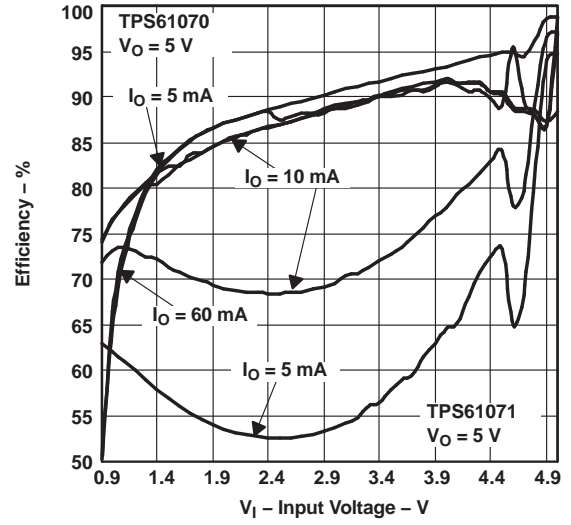

Figure 6. Efficiency vs Input Voltage

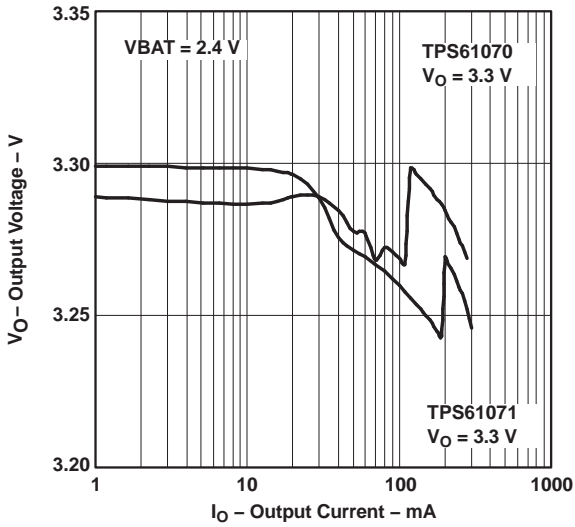

Figure 7. Output Voltage vs Output Current

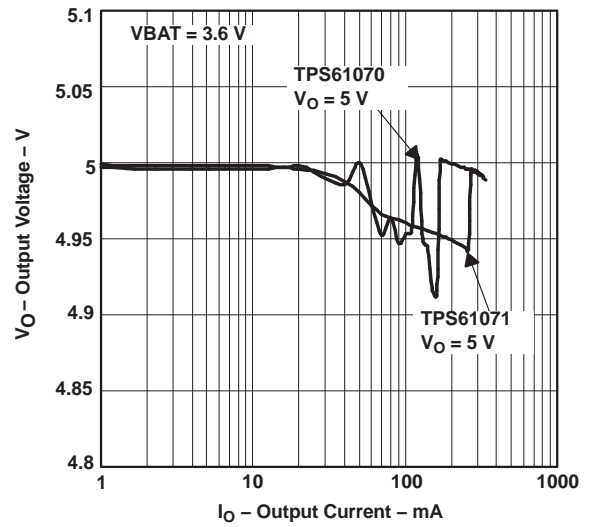

Figure 8. Output Voltage vs Output Current

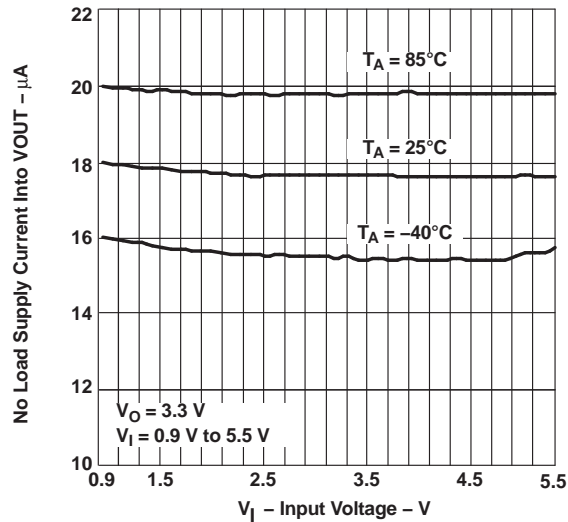
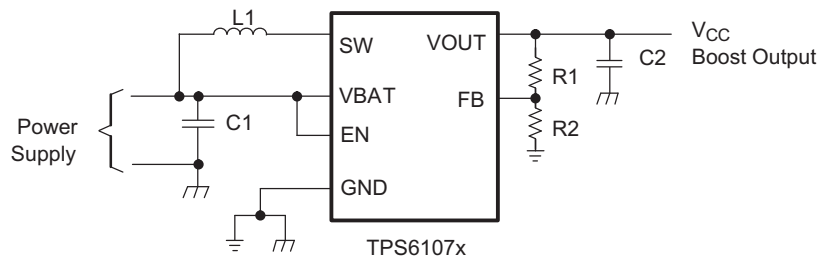

Figure 9. No Load Supply Current Into VOUT vs Input Voltage

9 Parameter Measurement Information



List of Components:

U1 = TPS61070DDC

L1 = 4.7 μ H Würth Elektronik 744031004

C1 = 2 x 4.7 μ F, 0603, X7R/X5R Ceramic

C2 = 4 x 4.7 μ F, 0603, X7R/X5R Ceramic

Figure 10. Parameter Measurement Schematic

10 Detailed Description

10.1 Overview

The TPS6107x devices provide a power supply solution for products powered by either a one-cell, two-cell, or three-cell alkaline, NiCd or NiMH, or one-cell Li-ion or Li-polymer battery. Output currents can go as high as 75 mA while using a single-cell alkaline, and discharge it down to 0.9 V. It can also be used for generating 5 V at 200 mA from a 3.3 V rail or a Li-ion battery. The boost converter is based on a fixed frequency, pulse-width-modulation (PWM) controller using a synchronous rectifier to obtain maximum efficiency. At low load currents the TPS61070 and TPS61073 enter the power-save mode to maintain a high efficiency over a wide load current range. The power-save mode is disabled in the TPS61071 and TPS61072, forcing the converters to operate at a fixed switching frequency. The maximum peak current in the boost switch is typically limited to a value of 600 mA. The TPS6107x output voltage is programmed by an external resistor divider. The converter can be disabled to minimize battery drain. During shutdown, the load is completely disconnected from the battery.

10.2 Functional Block Diagram

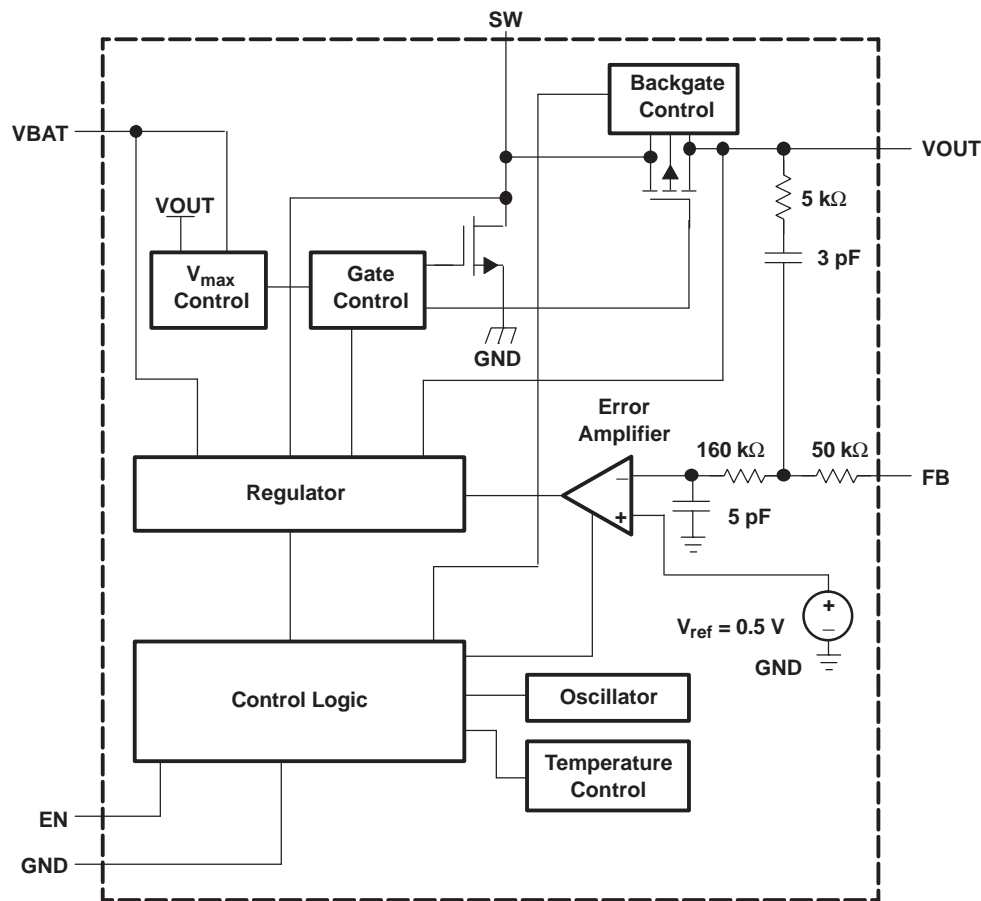

10.3 Feature Description

10.3.1 Controller Circuit

The controller circuit of the device is based on a fixed frequency multiple feedforward controller topology. Input voltage, output voltage, and voltage drop on the NMOS switch are monitored and forwarded to the regulator. So, changes in the operating conditions of the converter directly affect the duty cycle and must not take the indirect and slow way through the control loop and the error amplifier. The control loop, determined by the error amplifier, only has to handle small signal errors. The input for it is the feedback voltage on the FB pin. It is compared with the internal reference voltage to generate an accurate and stable output voltage.

Feature Description (continued)

The peak current of the NMOS switch is also sensed to limit the maximum current flowing through the switch and the inductor. The typical peak-current limit is set to 600 mA. An internal temperature sensor prevents the device from getting overheated in case of excessive power dissipation.

10.3.1.1 Synchronous Rectifier

The device integrates an N-channel and a P-channel MOSFET transistor to realize a synchronous rectifier. Because the commonly used discrete Schottky rectifier is replaced with a low $R_{DS(on)}$ PMOS switch, the power conversion efficiency reaches values above 90%. A special circuit is applied to disconnect the load from the input during shutdown of the converter. In conventional synchronous rectifier circuits, the backgate diode of the high-side PMOS is forward biased in shutdown and allows current flowing from the battery to the output. However, this device uses a special circuit which takes the cathode of the backgate diode of the high-side PMOS and disconnects it from the source when the regulator is not enabled (EN = low).

The benefit of this feature for the system design engineer is that the battery is not depleted during shutdown of the converter. No additional components must be added to the design to make sure that the battery is disconnected from the output of the converter.

10.3.1.2 Device Enable

The device is put into operation when EN is set high. It is put into a shutdown mode when EN is set to GND. In shutdown mode, the regulator stops switching, all internal control circuitry is switched off, and the load is isolated from the input (as described in the [Synchronous Rectifier](#) section). This also means that the output voltage can drop below the input voltage during shutdown. During start-up of the converter, the duty cycle and the peak current are limited in order to avoid high-peak currents drawn from the battery.

10.3.1.3 Undervoltage Lockout

An undervoltage lockout function prevents the device from operating if the supply voltage on VBAT is lower than approximately 0.8 V. When in operation and the battery is being discharged, the device automatically enters the shutdown mode if the voltage on VBAT drops below approximately 0.8 V. This undervoltage lockout function is implemented in order to prevent the malfunctioning of the converter.

10.3.1.4 Soft Start and Short-Circuit Protection

When the device enables, the internal start-up cycle starts with the first step, the precharge phase. During precharge, the rectifying switch is turned on until the output capacitor is charged to a value close to the input voltage. The rectifying switch is current limited during this phase. The current limit increases with the output voltage. This circuit also limits the output current under short-circuit conditions at the output. [Figure 11](#) shows the typical precharge current vs output voltage for specific input voltages:

Feature Description (continued)

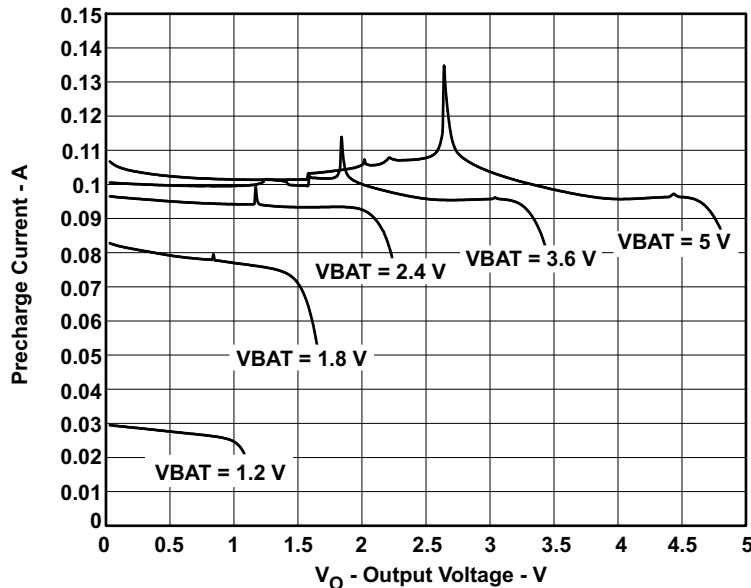

Figure 11. Precharge and Short-Circuit Current

After charging the output capacitor to the input voltage, the device starts switching. If the input voltage is below 1.8 V, the device works with a fixed duty cycle of 70% until the output voltage reaches 1.8 V. After that the duty cycle is set depending on the input output voltage ratio. Until the output voltage reaches its nominal value, the boost switch current limit is set to 50% of its nominal value to avoid high peak currents at the battery during start-up. As soon as the output voltage is reached, the regulator takes control, and the switch current limit is set back to 100%.

10.4 Device Functional Modes

10.4.1 Power-Save Mode

The TPS61070 and TPS61073 are capable of operating in two different modes. At light loads, when the inductor current becomes zero, they automatically enter the power-save mode to improve efficiency. In the power-save mode, the converters only operate when the output voltage trips below a set threshold voltage. It ramps up the output voltage with one or several pulses and returns to the power-save mode once the output voltage exceeds the set threshold voltage. If output power demand increases and the inductor current no longer goes below zero, the device again enters the fixed PWM mode. In this mode, there is no difference between the PWM only versions TPS61071 and TPS61072 and the power-save mode enabled versions TPS61070 and TPS61073.

11 Application and Implementation

NOTE

Information in the following applications sections is not part of the TI component specification, and TI does not warrant its accuracy or completeness. TI's customers are responsible for determining suitability of components for their purposes. Customers should validate and test their design implementation to confirm system functionality.

11.1 Application Information

The TPS6107x DC-DC converters are intended for systems powered by a single-cell, up to triple-cell alkaline, NiCd, NiMH battery with a typical terminal voltage between 0.9 V and 5.5 V. They can also be used in systems powered by one-cell Li-Ion or Li-Polymer with a typical voltage between 2.5 V and 4.2 V. Additionally, any other voltage source with a typical output voltage between 0.9 V and 5.5 V can power systems where the TPS6107x is used. Due to the nature of boost converters, the output voltage regulation is only maintained when the input voltage applied is lower than the programmed output voltage.

11.2 Typical Application

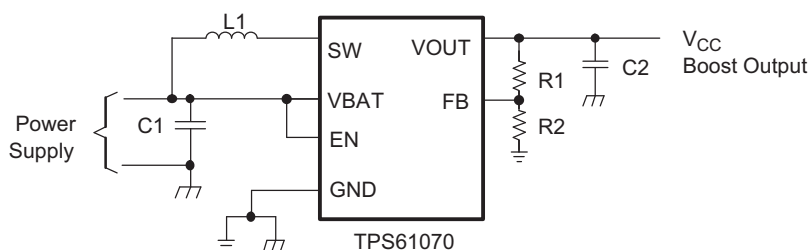

Figure 12. Typical Application Circuit for Adjustable Output Voltage Option

11.2.1 Design Requirements

In this example, TPS61070 is used to design a 3.3-V power supply with 75-mA output current capability. The TPS61200 can be powered by either a single-cell, two-cell, or three-cell alkaline, NiCd or NiMH, or one-cell Li-Ion or Li-Polymer battery. In this example, the input voltage range is from 0.9 V to 1.65 V for single-cell alkaline input design.

11.2.2 Detailed Design Procedure

11.2.2.1 Programming the Output Voltage

The output voltage of the TPS6107x dc/dc converter can be adjusted with an external resistor divider. The typical value of the voltage at the FB pin is 500 mV. The maximum recommended value for the output voltage is 5.5 V. The current through the resistive divider should be about 100 times greater than the current into the FB pin. The typical current into the FB pin is 0.01 μ A, and the voltage across R2 is typically 500 mV. Based on those two values, the recommended value for R2 should be lower than 500 k Ω , in order to set the divider current at 1 μ A or higher. Because of internal compensation circuitry, the value for this resistor should be in the range of 200 k Ω . From that, the value of resistor R1, depending on the needed output voltage (V_O), is calculated using [Equation 1](#):

$$R1 = R2 \times \left(\frac{V_O}{V_{FB}} - 1 \right) = 180 \text{ k}\Omega \times \left(\frac{V_O}{500 \text{ mV}} - 1 \right) \quad (1)$$

For example, if an output voltage of 3.3 V is needed, a 1 M Ω resistor should be chosen for R1. If for any reason the value chosen for R2 is significantly lower than 200 k Ω , additional capacitance in parallel to R1 is recommended, if the device shows instable regulation of the output voltage. The required capacitance value is calculated using [Equation 2](#):

$$C_{\text{parR1}} = 3\text{pF} \times \left(\frac{200\text{k}\Omega}{R2} - 1 \right) \quad (2)$$

Typical Application (continued)

11.2.2.2 Inductor Selection

A boost converter normally requires two main passive components for storing energy during the conversion. A boost inductor and a storage capacitor at the output are required. To select the boost inductor, it is recommended to keep the possible peak inductor current below the current limit threshold of the power switch in the chosen configuration. For example, the current limit threshold of the TPS6107x's switch is 600 mA. The highest peak current through the inductor and the switch depends on the output load, the input (V_{BAT}), and the output voltage (V_{OUT}). Estimation of the maximum average inductor current is done using [Equation 3](#):

$$L = I_O \times \frac{V_{OUT}}{V_{BAT} \times 0.8} \quad (3)$$

For example, for an output current of 75 mA at 3.3 V, at least 340 mA of average current flows through the inductor at a minimum input voltage of 0.9 V.

The second parameter for choosing the inductor is the desired current ripple in the inductor. Normally, it is advisable to work with a ripple of less than 20% of the average inductor current. A smaller ripple reduces the magnetic hysteresis losses in the inductor, as well as output voltage ripple and EMI. But in the same way, regulation time rises at load changes. In addition, a larger inductor increases the total system costs. With these parameters, it is possible to calculate the value for the inductor by using [Equation 4](#):

$$L = \frac{V_{BAT} \times (V_{OUT} - V_{BAT})}{\Delta I_L \times f \times V_{OUT}} \quad (4)$$

Parameter f is the switching frequency and ΔI_L is the ripple current in the inductor, i.e., 40% ΔI_L . In this example, the desired inductor has the value of 4 μ H. With this calculated value and the calculated currents, it is possible to choose a suitable inductor. In typical applications, a 4.7- μ H inductance is recommended. The device has been optimized to operate with inductance values between 2.2 μ H and 10 μ H. Nevertheless, operation with higher inductance values may be possible in some applications. Detailed stability analysis is then recommended. Care must be taken because load transients and losses in the circuit can lead to higher currents as estimated in [Equation 4](#). Also, the losses in the inductor caused by magnetic hysteresis losses and copper losses are a major parameter for total circuit efficiency.

The following inductor series from different suppliers have been used with the TPS6107x converters:

Table 1. List of Inductors

VENDOR	INDUCTOR SERIES
TDK	VLF3010
	VLF4012
Würth Elektronik	744031xxx
	744042xxx
EPCOS	B82462-G4
Cooper Electronics Technologies	SD18
	SD20
Taiyo Yuden	CB2016B xxx
	CB2518B xxx

11.2.2.3 Capacitor Selection

11.2.2.3.1 Input Capacitor

At least a 10 μ F input capacitor is recommended to improve transient behavior of the regulator and EMI behavior of the total power supply circuit. A ceramic capacitor or a tantalum capacitor with a 100-nF ceramic capacitor in parallel, placed close to the IC, is recommended.

11.2.2.3.2 Output Capacitor

The major parameter necessary to define the output capacitor is the maximum allowed output voltage ripple of the converter. This ripple is determined by two parameters of the capacitor, the capacitance and the ESR. It is possible to calculate the minimum capacitance needed for the defined ripple, supposing that the ESR is zero, by using [Equation 5](#):

$$C_{\min} = \frac{I_O \times (V_{OUT} - V_{BAT})}{f \times \Delta V \times V_{OUT}} \quad (5)$$

Parameter f is the switching frequency and ΔV is the maximum allowed ripple.

With a chosen ripple voltage of 10 mV, a minimum capacitance of 4.5 μF is needed. In this value range, ceramic capacitors are a good choice. The ESR and the additional ripple created are negligible. It is calculated using [Equation 6](#):

$$\Delta V_{\text{ESR}} = I_O \times R_{\text{ESR}} \quad (6)$$

The total ripple is the sum of the ripple caused by the capacitance and the ripple caused by the ESR of the capacitor. Additional ripple is caused by load transients. This means that the output capacitor has to completely supply the load during the charging phase of the inductor. The value of the output capacitance depends on the speed of the load transients and the load current during the load change. With the calculated minimum value of 4.5 μF and load transient considerations, the recommended output capacitance value is in a 10 μF range.

Care must be taken on capacitance loss caused by derating due to the applied dc voltage and the frequency characteristic of the capacitor. For example, larger form factor capacitors (in 1206 size) have their self resonant frequencies in the same frequency range as the TPS6107x operating frequency. So the effective capacitance of the capacitors used may be significantly lower. Therefore, the recommendation is to use smaller capacitors in parallel instead of one larger capacitor.

11.2.2.4 Small Signal Stability

To analyze small signal stability in more detail, the small signal transfer function of the error amplifier and the regulator, which is given in [Equation 7](#), can be used:

$$A_{(\text{REG})} = \frac{d}{V_{(\text{FB})}} = \frac{5 \times (R1 + R2)}{R2 \times (1 + i \times \omega \times 0.8 \mu\text{s})} \quad (7)$$

11.2.3 Application Curves

	FIGURE
Output voltage in continuous mode (TPS61071)	Figure 13
Output voltage in continuous mode (TPS61071)	Figure 14
Output voltage in power-save mode (TPS61070)	Figure 15
Output voltage in power-save mode (TPS61070)	Figure 16
Load transient response (TPS61071)	Figure 17
Load transient response (TPS61071)	Figure 18
Line transient response (TPS61071)	Figure 19
Line transient response (TPS61071)	Figure 20
Start-up after enable (TPS61070)	Figure 21
Start-up after enable (TPS61070)	Figure 22
Start-up after enable (TPS61071)	Figure 23
Start-up after enable (TPS61071)	Figure 24

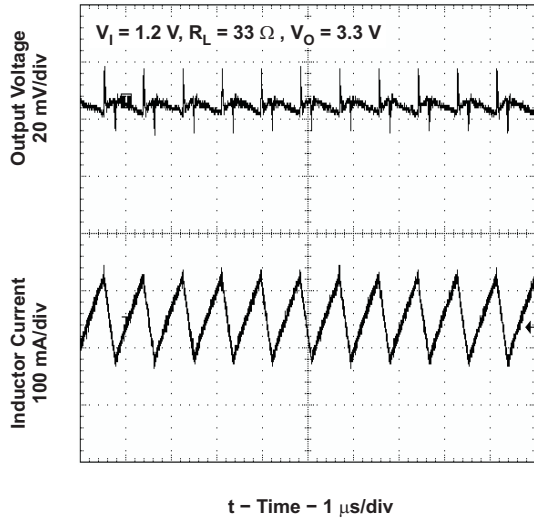

Figure 13. TPS61071 Output Voltage in Continuous Mode

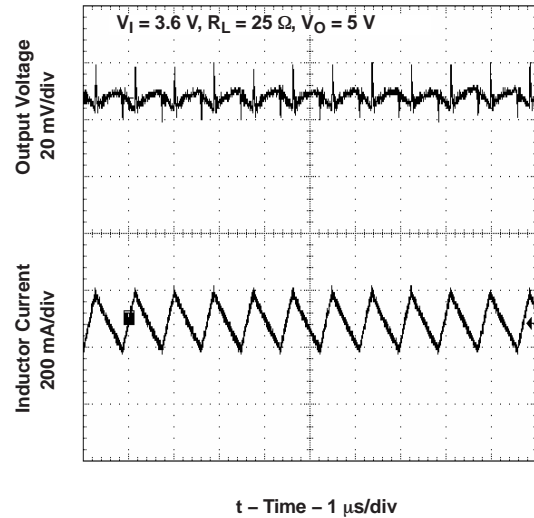

Figure 14. TPS61071 Output Voltage In Continuous Mode

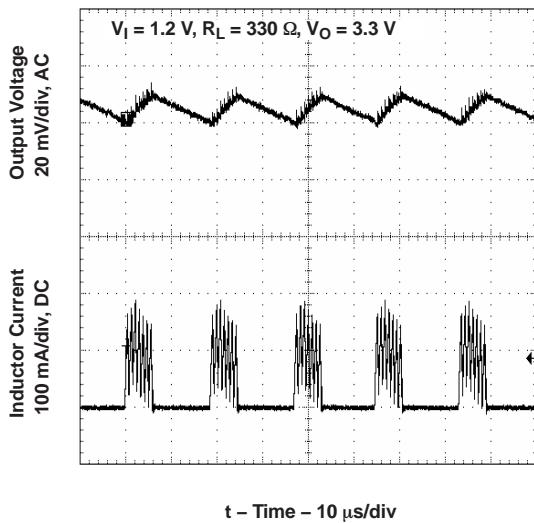

Figure 15. TPS61070 Output Voltage in Power-Save Mode

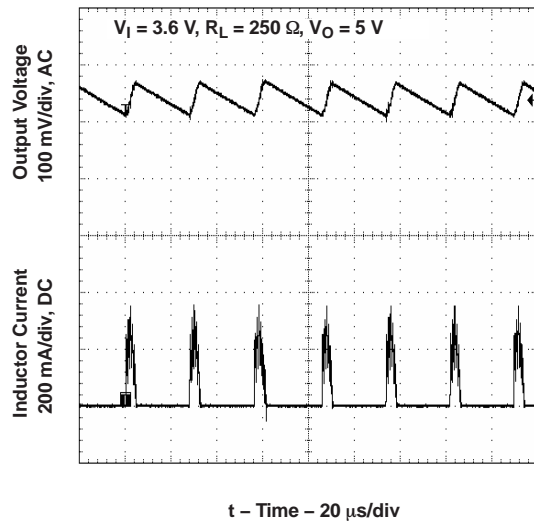

Figure 16. TPS61070 Output Voltage in Power-Save Mode

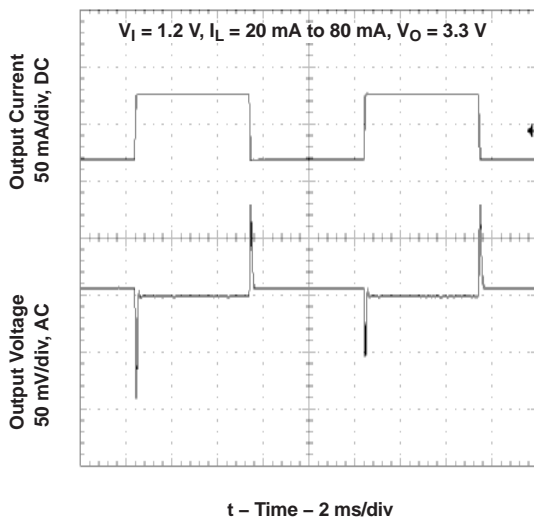

Figure 17. TPS61071 Load Transient Response

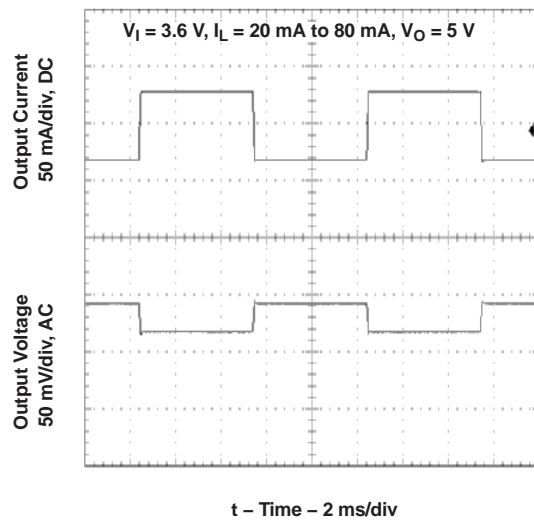
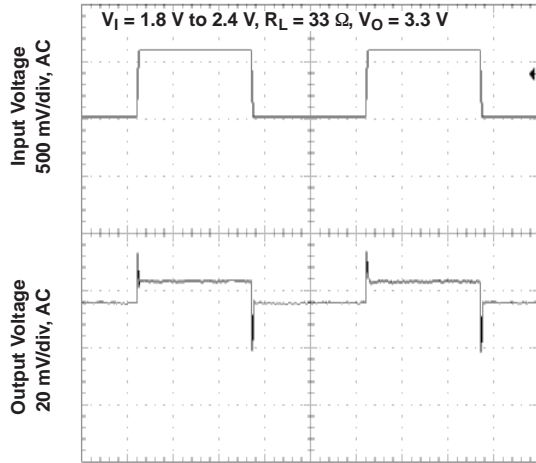
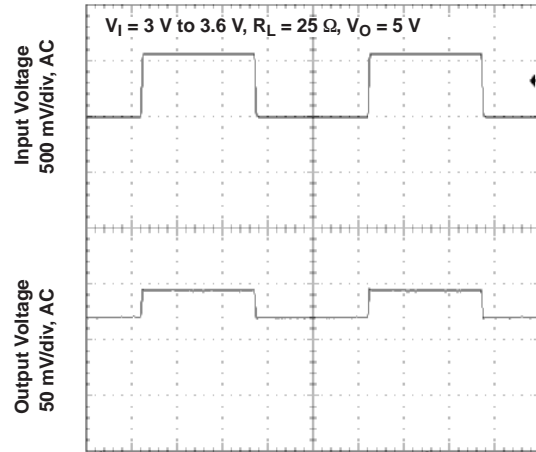

Figure 18. TPS61071 Load Transient Response



t – Time – 2 ms/div

Figure 19. TPS61071 Line Transient Response



t – Time – 2 ms/div

Figure 20. TPS61071 Line Transient Response

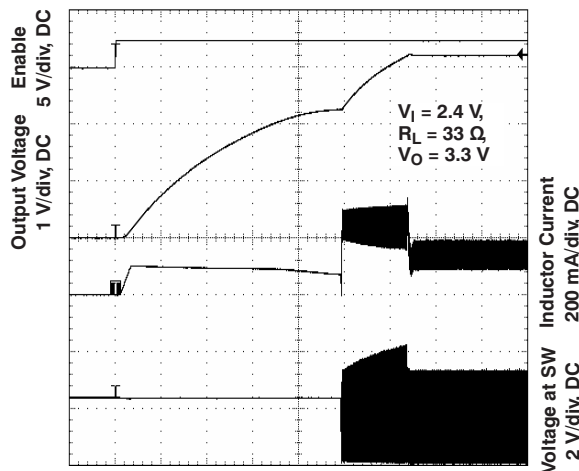

t – Time – 200 μs/div

Figure 21. TPS61070 Start-Up After Enable

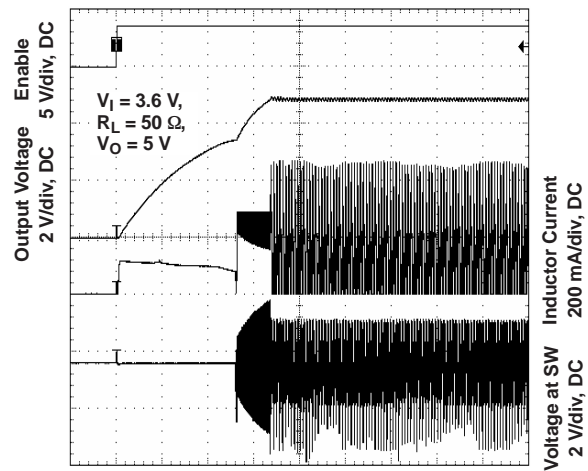

t – Time – 400 μs/div

Figure 22. TPS61070 Start-Up After Enable

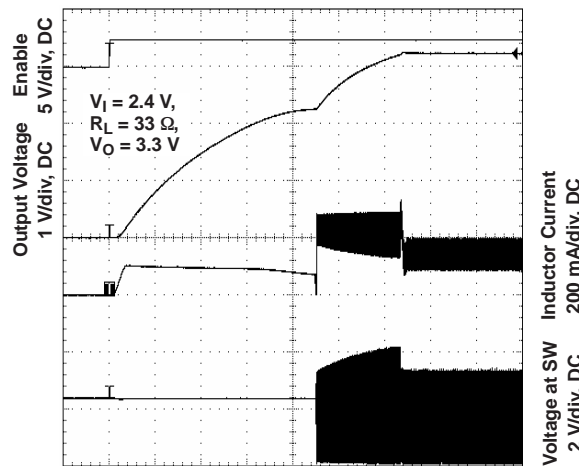

t – Time – 200 μs/div

Figure 23. TPS61071 Start-Up After Enable

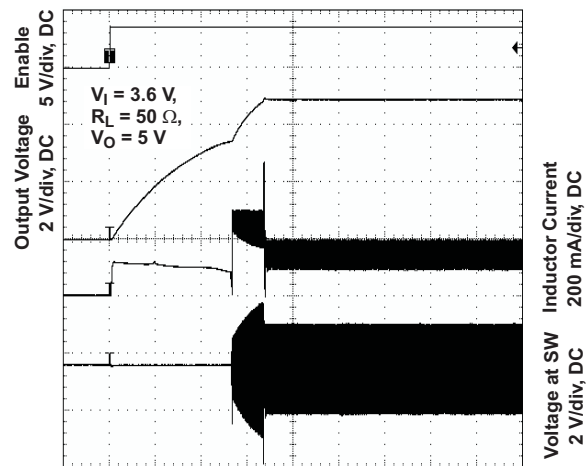

t – Time – 400 μs/div

Figure 24. TPS61071 Start-Up After Enable

11.3 System Examples

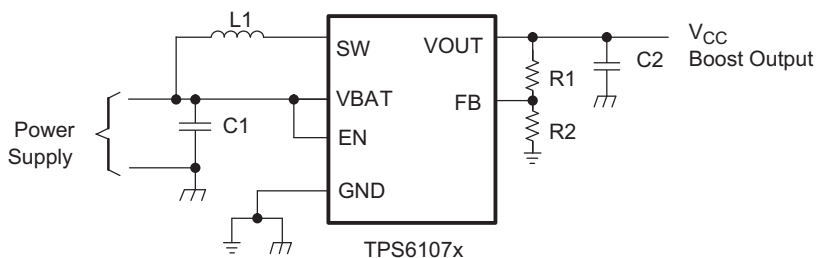

List of Components:

U1 = TPS61070DDC

L1 = 4.7 μ H Würth Elektronik 744031004

C1 = 2 x 4.7 μ F, 0603, X7R/X5R Ceramic

C2 = 2 x 4.7 μ F, 0603, X7R/X5R Ceramic

Figure 25. Power Supply Solution for Maximum Output Power Operating from a Single or Dual Alkaline Cell

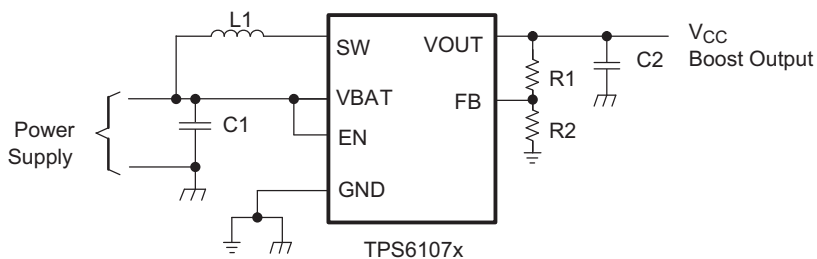

List of Components:

U1 = TPS61070DDC

L1 = 4.7 μ H Taiyo Yuden CB2016B4R7M

C1 = 1 x 4.7 μ F, 0603, X7R/X5R Ceramic

C2 = 2 x 4.7 μ F, 0603, X7R/X5R Ceramic

Figure 26. Power Supply Solution Having Small Total Solution Size

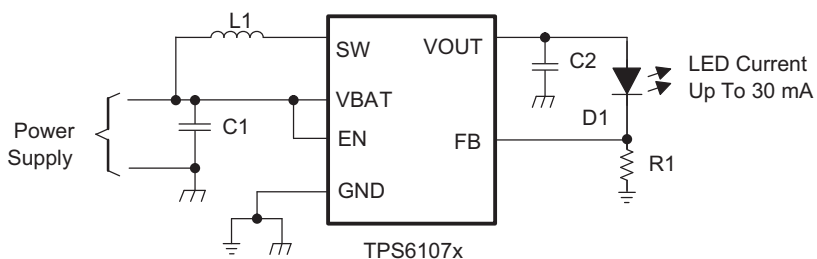

List of Components:

U1 = TPS61070DDC

L1 = 4.7 μ H Taiyo Yuden CB2016B4R7M

C1 = 1 x 4.7 μ F, 0603, X7R/X5R Ceramic

C2 = 2 x 4.7 μ F, 0603, X7R/X5R Ceramic

Figure 27. Power Supply Solution for Powering White LEDs in Lighting Applications

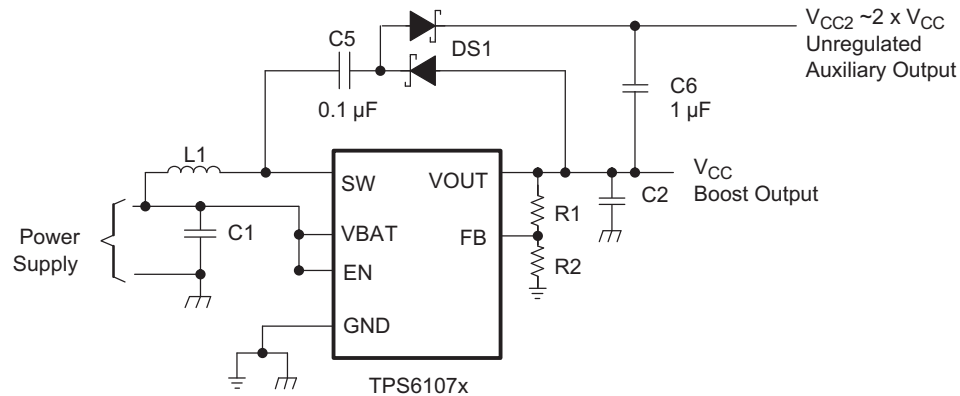
System Examples (continued)

List of Components:

U1 = TPS61070DDC

 L1 = 4.7 μ H Würth Elektronik 744031004

 C1 = 2 x 4.7 μ F, 0603, X7R/X5R Ceramic

 C2 = 2 x 4.7 μ F, 0603, X7R/X5R Ceramic

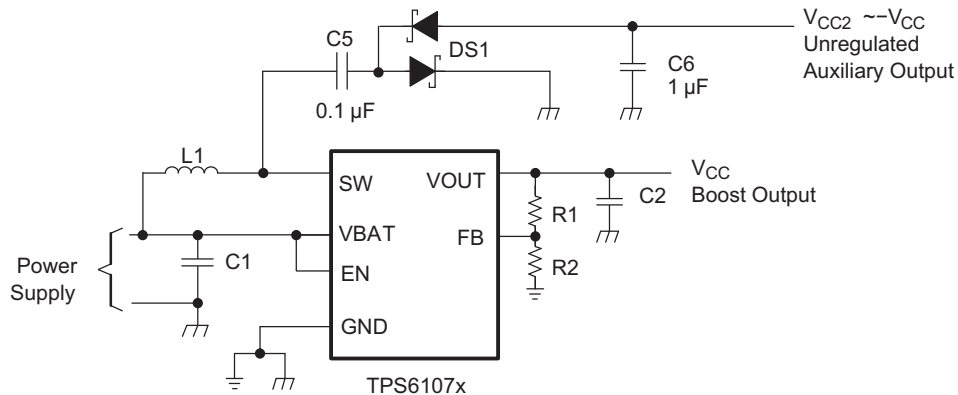
Figure 28. Power Supply Solution With Auxiliary Positive Output Voltage

List of Components:

U1 = TPS61070DDC

 L1 = 4.7 μ H Würth Elektronik 744031004

 C1 = 2 x 4.7 μ F, 0603, X7R/X5R Ceramic

 C2 = 2 x 4.7 μ F, 0603, X7R/X5R Ceramic

Figure 29. Power Supply Solution With Auxiliary Negative Output Voltage

12 Power Supply Recommendations

The power supply can be one-cell, two-cell, or three-cell alkaline, NiCd or NiMH, or one-cell Li-Ion or Li-Polymer battery. The input supply should be well regulated with the rating of TPS6107x. If the input supply is located more than a few inches from the device, additional bulk capacitance may be required in addition to the ceramic bypass capacitors. An electrolytic or tantalum capacitor with a value of 47 μF is a typical choice.

13 Layout

13.1 Layout Guidelines

As for all switching power supplies, the layout is an important step in the design, especially at high-peak currents and high switching frequencies. If the layout is not carefully done, the regulator could show stability problems as well as EMI problems. Therefore, use wide and short traces for the main current path and for the power ground tracks. The input capacitor, output capacitor, and the inductor should be placed as close as possible to the IC. Use a common ground node for power ground and a different one for control ground to minimize the effects of ground noise. Connect these ground nodes at any place close to the ground pin of the IC.

The feedback divider should be placed as close as possible to the ground pin of the IC. To lay out the control ground, it is recommended to use short traces as well, separated from the power ground traces. This avoids ground shift problems, which can occur due to superimposition of power ground current and control ground current.

13.2 Layout Example

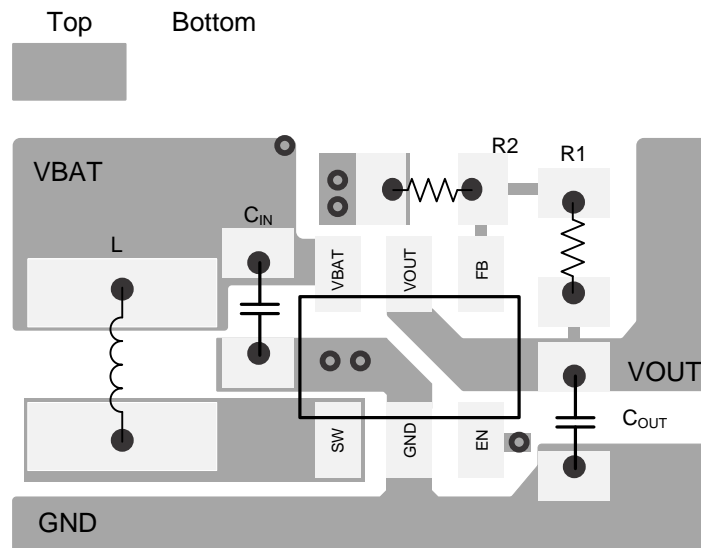

Figure 30. PCB Layout

13.3 Thermal Considerations

Implementation of integrated circuits in low-profile and fine-pitch surface-mount packages typically requires special attention to power dissipation. Many system-dependent issues such as thermal coupling, airflow, added heat sinks and convection surfaces, and the presence of other heat-generating components affect the power-dissipation limits of a given component.

Three basic approaches for enhancing thermal performance follow.

- Improving the power dissipation capability of the PCB design
- Improving the thermal coupling of the component to the PCB
- Introducing airflow in the system

The maximum recommended junction temperature (T_J) of the TPS6107x devices is 125°C. The thermal resistance of the 6-pin thin SOT package (DDC) is $R_{\theta JA} = 139.1^\circ\text{C}/\text{W}$. Specified regulator operation is assured to a maximum ambient temperature T_A of 85°C. Therefore, the maximum power dissipation is about 288 mW. More power can be dissipated if the maximum ambient temperature of the application is lower.

$$P_{D(\text{MAX})} = \frac{T_{J(\text{MAX})} - T_A}{R_{\theta JA}} = \frac{125^\circ\text{C} - 85^\circ\text{C}}{139.1^\circ\text{C} / \text{W}} = 288 \text{ mW} \quad (8)$$

14 Device and Documentation Support

14.1 Device Support

14.1.1 Third-Party Products Disclaimer

TI'S PUBLICATION OF INFORMATION REGARDING THIRD-PARTY PRODUCTS OR SERVICES DOES NOT CONSTITUTE AN ENDORSEMENT REGARDING THE SUITABILITY OF SUCH PRODUCTS OR SERVICES OR A WARRANTY, REPRESENTATION OR ENDORSEMENT OF SUCH PRODUCTS OR SERVICES, EITHER ALONE OR IN COMBINATION WITH ANY TI PRODUCT OR SERVICE.

14.2 Related Links

The table below lists quick access links. Categories include technical documents, support and community resources, tools and software, and quick access to sample or buy.

Table 2. Related Links

PARTS	PRODUCT FOLDER	SAMPLE & BUY	TECHNICAL DOCUMENTS	TOOLS & SOFTWARE	SUPPORT & COMMUNITY
TPS61070	Click here	Click here	Click here	Click here	Click here
TPS61071	Click here	Click here	Click here	Click here	Click here
TPS61072	Click here	Click here	Click here	Click here	Click here
TPS61073	Click here	Click here	Click here	Click here	Click here

14.3 Trademarks

All trademarks are the property of their respective owners.

14.4 Electrostatic Discharge Caution



These devices have limited built-in ESD protection. The leads should be shorted together or the device placed in conductive foam during storage or handling to prevent electrostatic damage to the MOS gates.

14.5 Glossary

[SLYZ022](#) — *TI Glossary*.

This glossary lists and explains terms, acronyms, and definitions.

15 Mechanical, Packaging, and Orderable Information

The following pages include mechanical, packaging, and orderable information. This information is the most current data available for the designated devices. This data is subject to change without notice and revision of this document. For browser-based versions of this data sheet, refer to the left-hand navigation.

PACKAGING INFORMATION

Orderable Device	Status (1)	Package Type	Package Drawing	Pins	Package Qty	Eco Plan (2)	Lead/Ball Finish (6)	MSL Peak Temp (3)	Op Temp (°C)	Device Marking (4/5)	Samples
TPS61070DDCR	ACTIVE	SOT-23-THIN	DDC	6	3000	Green (RoHS & no Sb/Br)	CU NIPDAU Call TI	Level-1-260C-UNLIM	-40 to 85	AUH	Samples
TPS61070DDCRG4	ACTIVE	SOT-23-THIN	DDC	6	3000	Green (RoHS & no Sb/Br)	CU NIPDAU	Level-1-260C-UNLIM	-40 to 85	AUH	Samples
TPS61071DDCR	ACTIVE	SOT-23-THIN	DDC	6	3000	Green (RoHS & no Sb/Br)	CU NIPDAU	Level-1-260C-UNLIM	-40 to 85	AUJ	Samples
TPS61071DDCRG4	ACTIVE	SOT-23-THIN	DDC	6	3000	Green (RoHS & no Sb/Br)	CU NIPDAU	Level-1-260C-UNLIM	-40 to 85	AUJ	Samples
TPS61072DDCR	ACTIVE	SOT-23-THIN	DDC	6	3000	Green (RoHS & no Sb/Br)	CU NIPDAU	Level-1-260C-UNLIM	-40 to 85	BUM	Samples
TPS61073DDCR	ACTIVE	SOT-23-THIN	DDC	6	3000	Green (RoHS & no Sb/Br)	CU NIPDAU	Level-1-260C-UNLIM	-40 to 85	BUN	Samples

(1) The marketing status values are defined as follows:

ACTIVE: Product device recommended for new designs.

LIFEBUY: TI has announced that the device will be discontinued, and a lifetime-buy period is in effect.

NRND: Not recommended for new designs. Device is in production to support existing customers, but TI does not recommend using this part in a new design.

PREVIEW: Device has been announced but is not in production. Samples may or may not be available.

OBSOLETE: TI has discontinued the production of the device.

(2) **RoHS:** TI defines "RoHS" to mean semiconductor products that are compliant with the current EU RoHS requirements for all 10 RoHS substances, including the requirement that RoHS substance do not exceed 0.1% by weight in homogeneous materials. Where designed to be soldered at high temperatures, "RoHS" products are suitable for use in specified lead-free processes. TI may reference these types of products as "Pb-Free".

RoHS Exempt: TI defines "RoHS Exempt" to mean products that contain lead but are compliant with EU RoHS pursuant to a specific EU RoHS exemption.

Green: TI defines "Green" to mean the content of Chlorine (Cl) and Bromine (Br) based flame retardants meet JS709B low halogen requirements of <=1000ppm threshold. Antimony trioxide based flame retardants must also meet the <=1000ppm threshold requirement.

(3) MSL, Peak Temp. - The Moisture Sensitivity Level rating according to the JEDEC industry standard classifications, and peak solder temperature.

(4) There may be additional marking, which relates to the logo, the lot trace code information, or the environmental category on the device.

(5) Multiple Device Markings will be inside parentheses. Only one Device Marking contained in parentheses and separated by a "~" will appear on a device. If a line is indented then it is a continuation of the previous line and the two combined represent the entire Device Marking for that device.

⁽⁶⁾ Lead/Ball Finish - Orderable Devices may have multiple material finish options. Finish options are separated by a vertical ruled line. Lead/Ball Finish values may wrap to two lines if the finish value exceeds the maximum column width.

Important Information and Disclaimer:The information provided on this page represents TI's knowledge and belief as of the date that it is provided. TI bases its knowledge and belief on information provided by third parties, and makes no representation or warranty as to the accuracy of such information. Efforts are underway to better integrate information from third parties. TI has taken and continues to take reasonable steps to provide representative and accurate information but may not have conducted destructive testing or chemical analysis on incoming materials and chemicals. TI and TI suppliers consider certain information to be proprietary, and thus CAS numbers and other limited information may not be available for release.

In no event shall TI's liability arising out of such information exceed the total purchase price of the TI part(s) at issue in this document sold by TI to Customer on an annual basis.

OTHER QUALIFIED VERSIONS OF TPS61071 :

- Automotive: [TPS61071-Q1](#)

NOTE: Qualified Version Definitions:

- Automotive - Q100 devices qualified for high-reliability automotive applications targeting zero defects

TAPE AND REEL INFORMATION

QUADRANT ASSIGNMENTS FOR PIN 1 ORIENTATION IN TAPE

*All dimensions are nominal

Device	Package Type	Package Drawing	Pins	SPQ	Reel Diameter (mm)	Reel Width W1 (mm)	A0 (mm)	B0 (mm)	K0 (mm)	P1 (mm)	W (mm)	Pin1 Quadrant
TPS61070DDCR	SOT-23-THIN	DDC	6	3000	179.0	8.4	3.2	3.2	1.4	4.0	8.0	Q3
TPS61071DDCR	SOT-23-THIN	DDC	6	3000	179.0	8.4	3.2	3.2	1.4	4.0	8.0	Q3
TPS61072DDCR	SOT-23-THIN	DDC	6	3000	179.0	8.4	3.2	3.2	1.4	4.0	8.0	Q3
TPS61073DDCR	SOT-23-THIN	DDC	6	3000	179.0	8.4	3.2	3.2	1.4	4.0	8.0	Q3

TAPE AND REEL BOX DIMENSIONS

*All dimensions are nominal

Device	Package Type	Package Drawing	Pins	SPQ	Length (mm)	Width (mm)	Height (mm)
TPS61070DDCR	SOT-23-THIN	DDC	6	3000	203.0	203.0	35.0
TPS61071DDCR	SOT-23-THIN	DDC	6	3000	203.0	203.0	35.0
TPS61072DDCR	SOT-23-THIN	DDC	6	3000	203.0	203.0	35.0
TPS61073DDCR	SOT-23-THIN	DDC	6	3000	203.0	203.0	35.0

DDC (R-PDSO-G6)

PLASTIC SMALL-OUTLINE

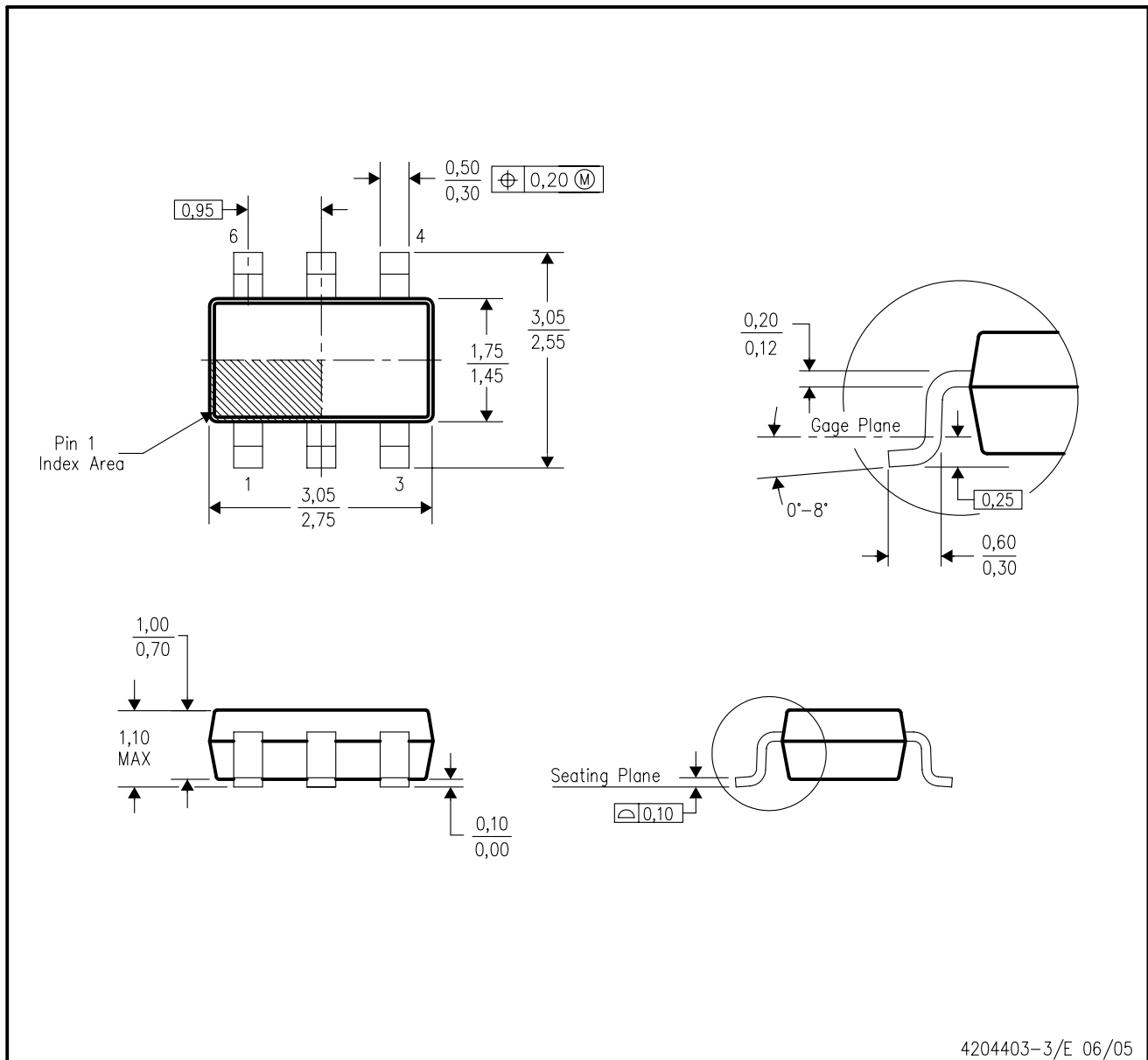

- NOTES:
- All linear dimensions are in millimeters.
 - This drawing is subject to change without notice.
 - Body dimensions do not include mold flash or protrusion.
 - Falls within JEDEC MO-193 variation AA (6 pin).

DDC (R-PDSO-G6)

PLASTIC SMALL OUTLINE

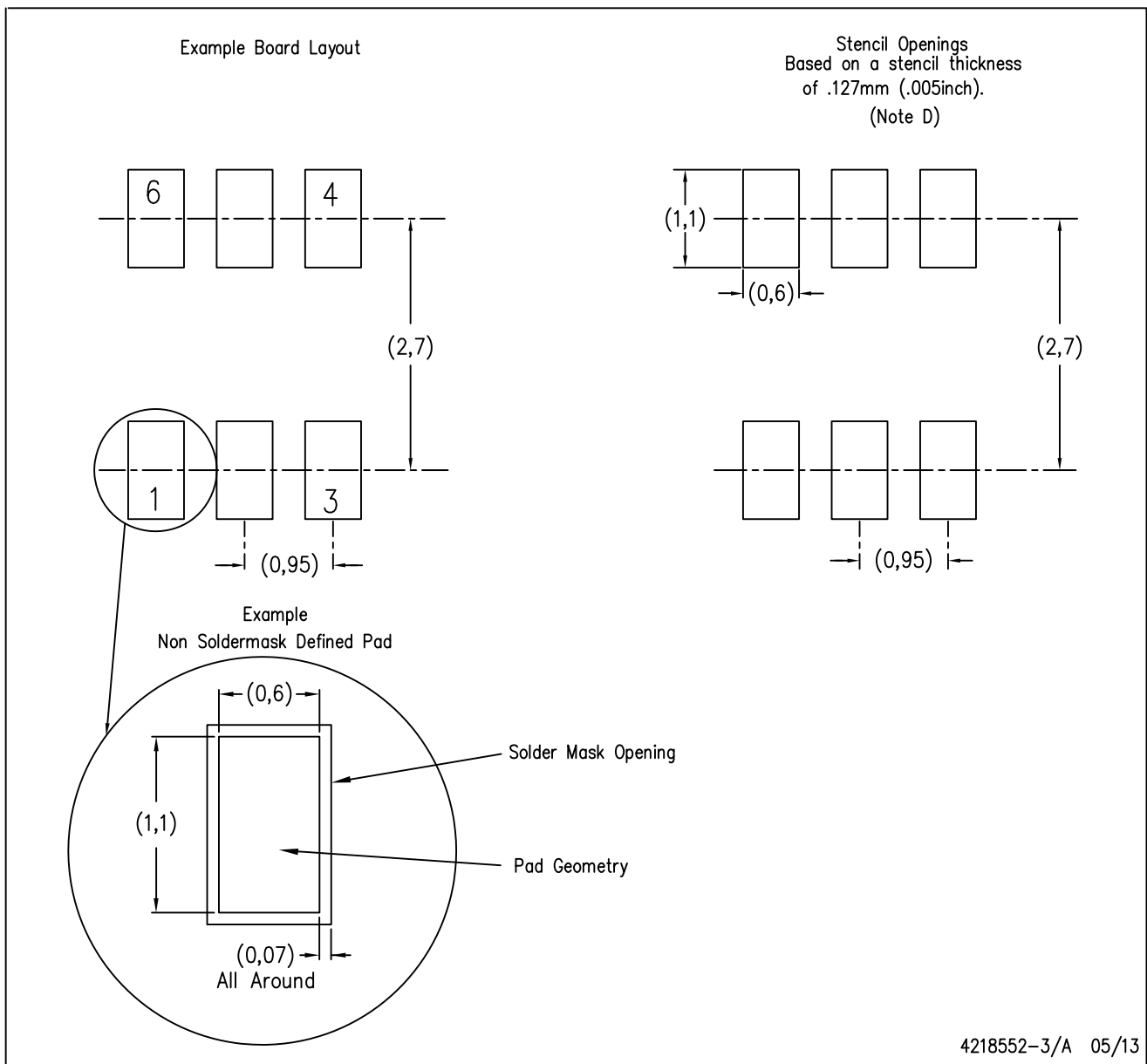

- NOTES:
- A. All linear dimensions are in millimeters.
 - B. This drawing is subject to change without notice.
 - C. Publication IPC-7351 is recommended for alternate designs.
 - D. Laser cutting apertures with trapezoidal walls and also rounding corners will offer better paste release. Customers should contact their board assembly site for stencil design recommendations. Example stencil design based on a 50% volumetric metal load solder paste. Refer to IPC-7525 for other stencil recommendations.

IMPORTANT NOTICE AND DISCLAIMER

TI PROVIDES TECHNICAL AND RELIABILITY DATA (INCLUDING DATASHEETS), DESIGN RESOURCES (INCLUDING REFERENCE DESIGNS), APPLICATION OR OTHER DESIGN ADVICE, WEB TOOLS, SAFETY INFORMATION, AND OTHER RESOURCES "AS IS" AND WITH ALL FAULTS, AND DISCLAIMS ALL WARRANTIES, EXPRESS AND IMPLIED, INCLUDING WITHOUT LIMITATION ANY IMPLIED WARRANTIES OF MERCHANTABILITY, FITNESS FOR A PARTICULAR PURPOSE OR NON-INFRINGEMENT OF THIRD PARTY INTELLECTUAL PROPERTY RIGHTS.

These resources are intended for skilled developers designing with TI products. You are solely responsible for (1) selecting the appropriate TI products for your application, (2) designing, validating and testing your application, and (3) ensuring your application meets applicable standards, and any other safety, security, or other requirements. These resources are subject to change without notice. TI grants you permission to use these resources only for development of an application that uses the TI products described in the resource. Other reproduction and display of these resources is prohibited. No license is granted to any other TI intellectual property right or to any third party intellectual property right. TI disclaims responsibility for, and you will fully indemnify TI and its representatives against, any claims, damages, costs, losses, and liabilities arising out of your use of these resources.

TI's products are provided subject to TI's Terms of Sale (www.ti.com/legal/termsofsale.html) or other applicable terms available either on ti.com or provided in conjunction with such TI products. TI's provision of these resources does not expand or otherwise alter TI's applicable warranties or warranty disclaimers for TI products.

Mailing Address: Texas Instruments, Post Office Box 655303, Dallas, Texas 75265
Copyright © 2019, Texas Instruments Incorporated