

# Nano-Power, CMOS Input, RRIO, Push-Pull Output Comparator

## FEATURES

- Low supply current  
400nA (TYP) at  $V_s = 1.4V$
- Low input offset voltage :  $V_{os(max)} = 5mV$
- Rail-to-Rail Input and output
- SUPPLY RANGE: +1.4V to +5.5V
- SPECIFIED UP TO +125°C
- *Micro*SIZE PACKAGES: SOT23-5/SC70-5

## APPLICATIONS

- OVERVOLTAGE AND UNDERVOLTAGE DETECTION
- MULTIVIBRATORS
- OVERCURRENT DETECTION
- SYSTEM MONITORING
- BATTERY POWERED SYSTEM

## DESCRIPTION

The RS8901 offers a wide supply range, low quiescent current 400nA (TYP), and rail-to-rail inputs. All of these features come in industry-standard and extremely small packages, making this device an excellent choice for low-voltage and low-power applications for portable electronics and industrial systems.

Featuring a push-pull output stage, the RS8901 allows for operation with absolute minimum power consumption when driving any capacitive or resistive load.

The devices are ideal for system monitoring, include tablets, portable medical, smart phones. The RS8901 is specified at the full temperature range of -40°C to +125°C under single power supplies of 1.4V to 5.5V.

## PIN CONFIGURATIONS

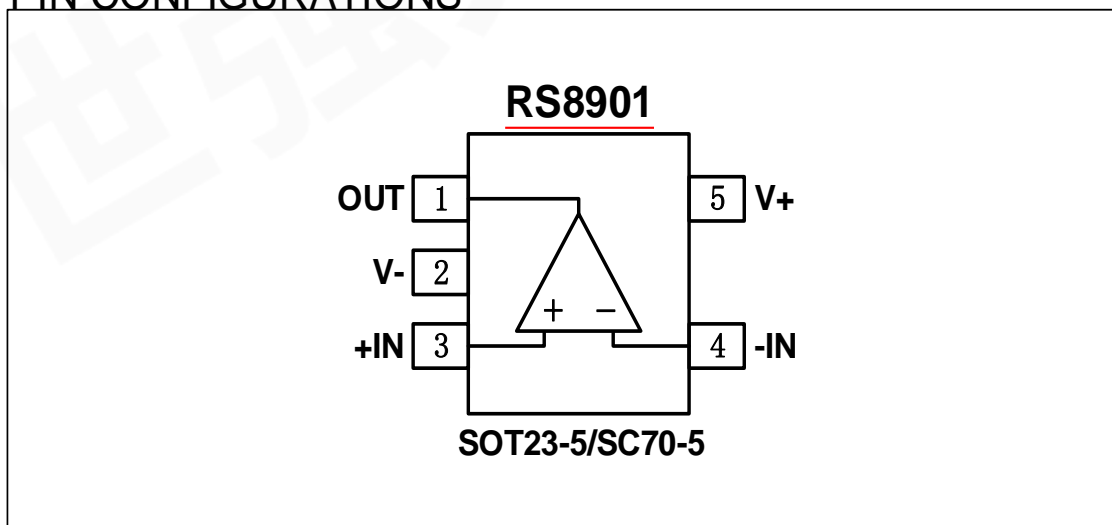

**ABSOLUTE MAXIMUM RATINGS <sup>(1)</sup>**

Supply Voltage, V+ to V-.....	7.0V
Input Terminals, Voltage <sup>(2)</sup> .....	- 0.5 to (V+) + 0.5V
Current <sup>(2)</sup> .....	±10mA
Storage Temperature .....	-65°C to +150°C
Operating Temperature .....	-40°C to +125°C
Junction Temperature.....	150°C
Lead Temperature (Soldering, 10s) .....	260°C
<b>ESD Susceptibility</b>	
HBM .....	3000V
MM .....	400V

**ESD SENSITIVITY CAUTION**

ESD damage can range from subtle performance degradation to complete device failure. Precision integrated circuits may be more susceptible to damage because very small parametric changes could cause the device not to meet its published specifications.

(1) Stresses above these ratings may cause permanent damage. Exposure to absolute maximum conditions for extended periods may degrade device reliability. These are stress ratings only, and functional operation of the device at these or any other conditions beyond those specified is not implied.

(2) Input terminals are diode-clamped to the power-supply rails. Input signals that can swing more than 0.5V beyond the supply rails should be current-limited to 10mA or less.

**PACKAGE/ORDERING INFORMATION**

PRODUCT	ORDERING NUMBER	TEMPERATURE RANGE	PACKAGE LEAD	PACKAGE MARKING	PACKAGE OPTION
<u>RS8901</u>	<u>RS8901XF</u>	-40°C~125°C	SOT23-5	8901	Tape and Reel,3000
	<u>RS8901XC5</u>	-40°C~125°C	SC70-5	8901	Tape and Reel,3000

**ELECTRICAL CHARACTERISTICS**

 (At  $T_A = +25^\circ\text{C}$ ,  $V_S = 1.4\text{V}$  to  $5.5\text{V}$ ,  $V_{CM} = V_S/2$ ,  $C_L = 15\text{pF}$ , unless otherwise noted.)

PARAMETER		CONDITIONS	RS8901			UNITS
			MIN	TYP	MAX	
<b>POWER SUPPLY</b>						
$V_S$	Operating Voltage Range		1.4		5.5	V
$I_Q$	Quiescent Current			400	1500	nA
PSRR	Power-Supply Rejection Ratio	$V_S = 1.4\text{V}$ to $5.5\text{V}$ , $V_{CM} = (V_-) + 0.5\text{V}$	68	90		dB
<b>INPUT</b>						
$V_{OS}$	Input Offset Voltage	$V_{CM} = V_S/2$		$\pm 2$	$\pm 5$	mV
$\Delta V_{OS}/\Delta T$	Input Offset Voltage Drift	$V_{CM} = V_S/2$ , $-40^\circ\text{C} \leq T_A \leq 125^\circ\text{C}$		2		$\mu\text{V}/^\circ\text{C}$
$I_B$	Input Bias Current			1	10	pA
$V_{CM}$	Common-Mode Voltage Range	$T_A = -40^\circ\text{C}$ to $125^\circ\text{C}$	$(V_-) - 0.1$		$(V_+) + 0.1$	V
<b>OUTPUT</b>						
$V_{OH}$	Output Swing From Upper Rail	$V_S = 1.4\text{V}$ , $I_O = 0.1\text{mA}$		70	75	mV
		$V_S = 5.0\text{V}$ , $I_O = 2.5\text{mA}$		140	170	mV
$V_{OH}$	Output Swing From Lower Rail	$V_S = 1.4\text{V}$ , $I_O = -0.1\text{mA}$		35	40	mV
		$V_S = 5.0\text{V}$ , $I_O = -2.5\text{mA}$		85	115	mV
$I_{SC}$	Short Circuit Sink Current	$V_S = 5.0\text{V}$		45		mA
	Short Circuit Source Current	$V_S = 5.0\text{V}$		40		mA
<b>SWITCHING</b>						
$T_{PHL}$	Propagation Delay H To L	$V_S = 5.0\text{V}$ , Overdrive = 10 mV		13		$\mu\text{s}$
		$V_S = 5.0\text{V}$ , Overdrive = 100 mV		6		
		$V_S = 2.5\text{V}$ , Overdrive = 10 mV		12		
		$V_S = 2.5\text{V}$ , Overdrive = 100 mV		5		
		$V_S = 1.4\text{V}$ , Overdrive = 10 mV		13		
		$V_S = 1.4\text{V}$ , Overdrive = 100 mV		6		
$T_{PLH}$	Propagation Delay L To H	$V_S = 5.0\text{V}$ , Overdrive = 10 mV		20		
		$V_S = 5.0\text{V}$ , Overdrive = 100 mV		22		
		$V_S = 2.5\text{V}$ , Overdrive = 10 mV		15		
		$V_S = 2.5\text{V}$ , Overdrive = 100 mV		18		
		$V_S = 1.4\text{V}$ , Overdrive = 10 mV		15		
		$V_S = 1.4\text{V}$ , Overdrive = 100 mV		18		
$T_R$	Rise Time	Overdrive = 100 mV		200		ns
$T_F$	Fall Time	Overdrive = 100 mV		200		ns

### TYPICAL CHARACTERISTICS

At  $T_A = +25^\circ\text{C}$ ,  $V_S = 5\text{V}$ ,  $V_{CM} = V_S/2$ ,  $C_L = 15\text{pF}$  unless otherwise noted.

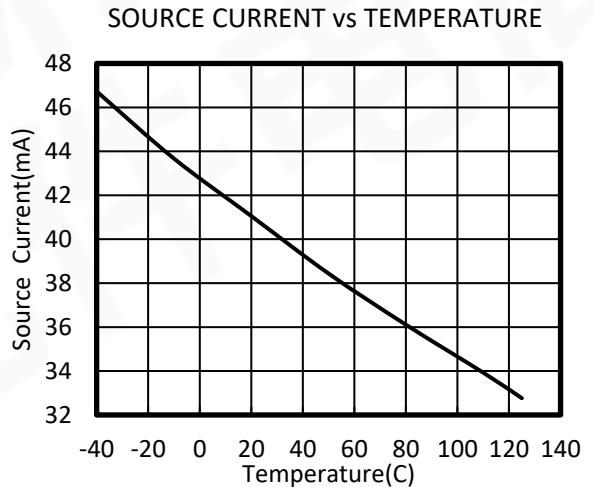
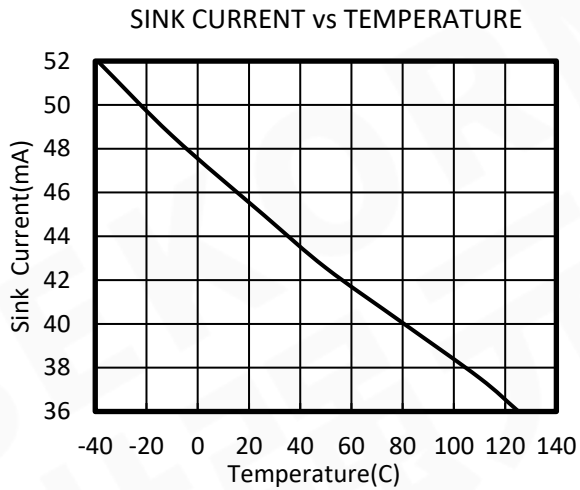
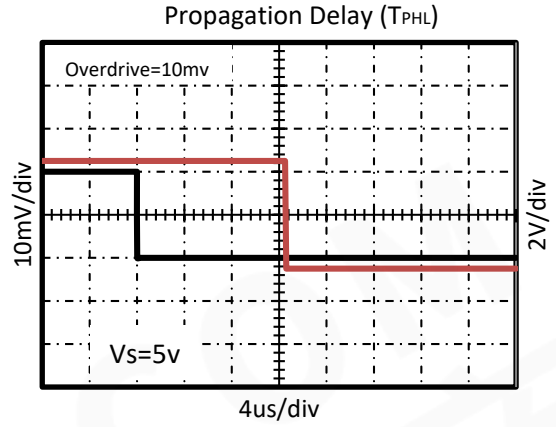
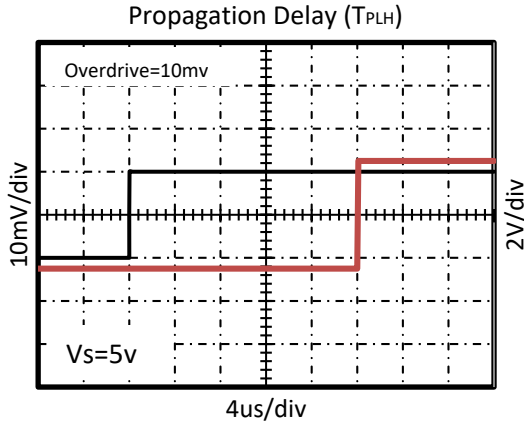

# PACKAGE OUTLINE DIMENSIONS

## SOT23-5

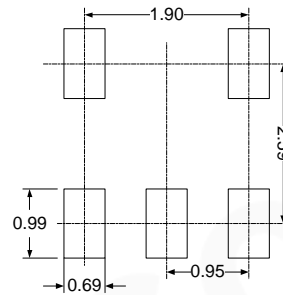
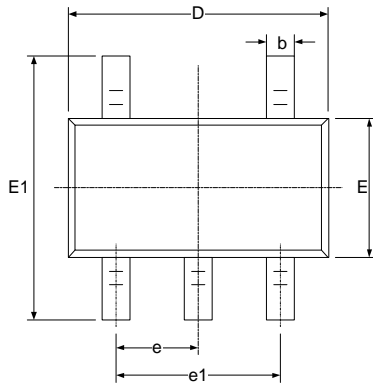
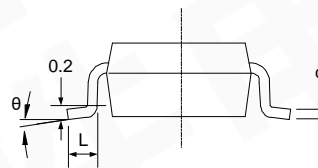
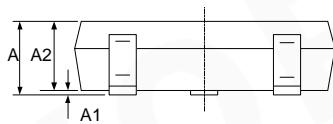
**RECOMMENDED LAND PATTERN (Unit: mm)**

Symbol	Dimensions In Millimeters		Dimensions In Inches	
	Min	Max	Min	Max
A	1.050	1.250	0.041	0.049
A1	0.000	0.100	0.000	0.004
A2	1.050	1.150	0.041	0.045
b	0.300	0.500	0.012	0.020
c	0.100	0.200	0.004	0.008
D	2.820	3.020	0.111	0.119
E	1.500	1.700	0.059	0.067
E1	2.650	2.950	0.104	0.116
e	0.950(BSC)		0.037(BSC)	
e1	1.800	2.000	0.071	0.079
L	0.300	0.600	0.012	0.024
$\theta$	0°	8°	0°	8°

# SC70-5

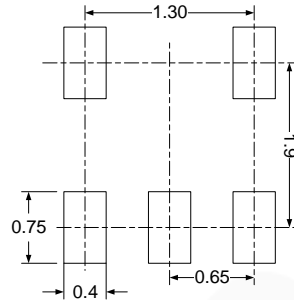
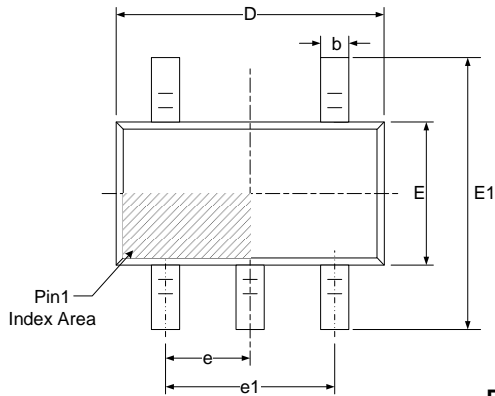
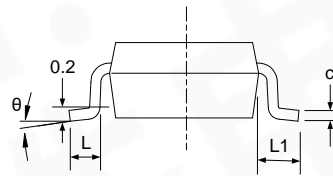
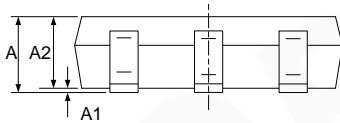
**RECOMMENDED LAND PATTERN (Unit: mm)**

Symbol	Dimensions In Millimeters		Dimensions In Inches	
	Min	Max	Min	Max
A	0.900	1.100	0.035	0.043
A1	0.000	0.100	0.000	0.004
A2	0.900	1.000	0.035	0.039
b	0.150	0.350	0.006	0.014
c	0.080	0.150	0.003	0.006
D	2.000	2.200	0.079	0.087
E	1.150	1.350	0.045	0.053
E1	2.150	2.450	0.085	0.096
e	0.650(BSC)		0.026(BSC)	
e1	1.300(BSC)		0.051(BSC)	
L	0.260	0.460	0.010	0.018
L1	0.525		0.021	
θ	0°	8°	0°	8°