

# 1MHz, Precision, Rail-to-Rail I/O CMOS Operational Amplifier

## FEATURES

- HIGH GAIN BANDWIDTH: 1MHz
- RAIL-TO-RAIL INPUT AND OUTPUT  
 $\pm 4.5\text{mV Max Vos}$
- INPUT VOLTAGE RANGE:  $-0.1\text{V to } +5.6\text{V}$   
with  $V_s = 5.5\text{V}$
- SUPPLY RANGE:  $+2.5\text{V to } +5.5\text{V}$
- SPECIFIED UP TO  $+125^\circ\text{C}$
- *Micro* SIZE PACKAGES:  
SOT23-5, SOT353/SC70-5

## APPLICATIONS

- SENSORS
- PHOTODIODE AMPLIFICATION
- ACTIVE FILTERS
- TEST EQUIPMENT
- DRIVING A/D CONVERTERS

## DESCRIPTION

The RS321K, RS358K, RS324K families of products offer low voltage operation and rail-to-rail input and output, as well as excellent speed/power consumption ratio, providing an excellent bandwidth (1MHz) and slew rate of 0.45V/us. The op-amps are unity gain stable and feature an ultra-low input bias current.

The RS321K, RS358K and RS324K has lower offset, which is guaranteed not upper than  $\pm 4.5\text{mV}$  at  $25^\circ\text{C}$  with  $V_s = 5\text{V}$ ,  $V_{\text{CM}} = V_s/2$ .

The devices are ideal for sensor interfaces, active filters and portable applications. The RS321K, RS358K, RS324K families of operational amplifiers are specified at the full temperature range of  $-40^\circ\text{C}$  to  $+125^\circ\text{C}$ .

## PIN CONFIGURATIONS

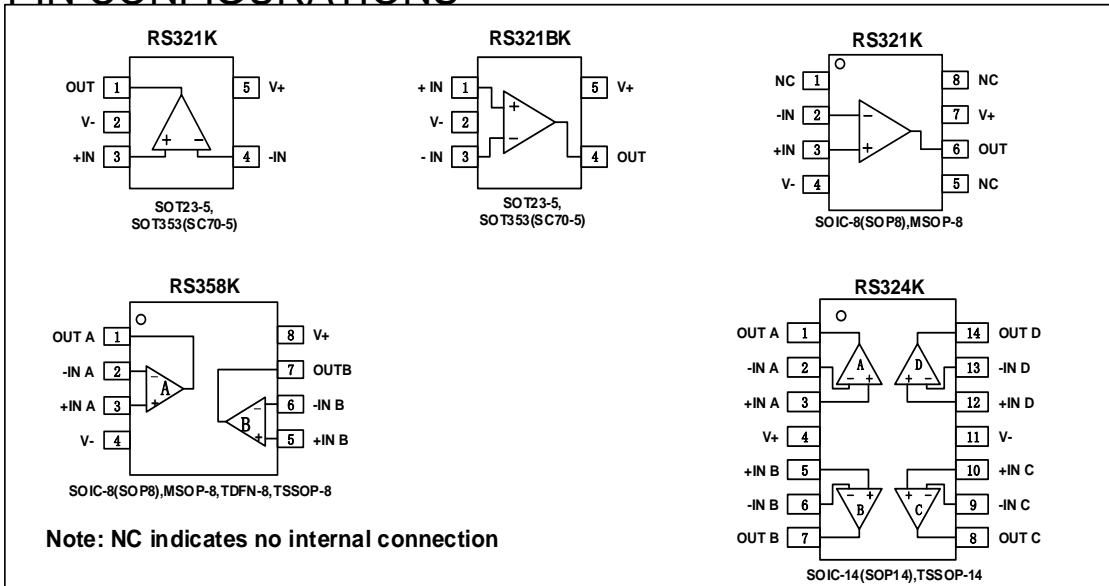

**ABSOLUTE MAXIMUM RATINGS <sup>(1)</sup>**

Supply Voltage, V+ to V-.....	7.0V
Input Terminals, Voltage <sup>(2)</sup> .....	- 0.5 to (V+) + 0.5V
Current <sup>(2)</sup> .....	±10mA
Storage Temperature .....	-65°C to +150°C
Operating Temperature .....	-40°C to +125°C
Junction Temperature.....	150°C
Package Thermal Resistance @ T <sub>A</sub> = +25°C	
SOT23-5, SOT23-6.....	200°C/W
MSOP-10, SOIC-8, TSSOP-8.....	150°C/W
SOIC-14, TSSOP-14.....	100°C/W
Lead Temperature (Soldering, 10s) .....	260°C
ESD Susceptibility	
HBM .....	3000V
MM .....	200V

**ESD SENSITIVITY CAUTION**

ESD damage can range from subtle performance degradation to complete device failure. Precision integrated circuits may be more susceptible to damage because very small parametric changes could cause the device not to meet its published specifications.

(1) Stresses above these ratings may cause permanent damage. Exposure to absolute maximum conditions for extended periods may degrade device reliability. These are stress ratings only, and functional operation of the device at these or any other conditions beyond those specified is not implied.

(2) Input terminals are diode-clamped to the power-supply rails. Input signals that can swing more than 0.5V beyond the supply rails should be current-limited to 10mA or less.

**PACKAGE/ORDERING INFORMATION**

PRODUCT	ORDERING NUMBER	TEMPERATURE RANGE	PACKAGE LEAD	PACKAGE MARKING	PACKAGE OPTION
RS321K	RS321KXK	-40°C ~125°C	SOIC-8(SOP8)	RS321K	Tape and Reel,2500
	RS321KXF	-40°C ~125°C	SOT23-5	321K	Tape and Reel,3000
	RS321BKXF	-40°C ~125°C	SOT23-5	321BK	Tape and Reel,3000
	RS321KXM	-40°C ~125°C	MSOP-8	RS321K	Tape and Reel,3000
	RS321KXC5	-40°C ~125°C	SOT353(SC70-5)	321K	Tape and Reel,3000
	RS321BKXC5	-40°C ~125°C	SOT353(SC70-5)	321BK	Tape and Reel,3000
RS358K	RS358KXK	-40°C ~125°C	SOIC-8(SOP8)	RS358K	Tape and Reel,2500
	RS358KXM	-40°C ~125°C	MSOP-8	RS358K	Tape and Reel,3000
	RS358KXTDC8	-40°C ~125°C	TDFN3x3-8	RS358K	Tape and Reel,3000
	RS358KXQ	-40°C ~125°C	TSSOP-8	RS358K	Tape and Reel,3000
RS324K	RS324KXP	-40°C ~125°C	SOIC-14(SOP14)	RS324K	Tape and Reel,2500
	RS324KXQ	-40°C ~125°C	TSSOP-14	RS324K	Tape and Reel,3000

**ELECTRICAL CHARACTERISTICS**

 (At  $T_A = +25^\circ\text{C}$ ,  $V_S = 5\text{V}$ ,  $R_L = 10\text{k}\Omega$  connected to  $V_S/2$ , and  $V_{OUT} = V_S/2$ , unless otherwise noted.)

PARAMETER		CONDITIONS	$T_J$	RS321K, RS358K, RS324K			UNITS
				MIN	TYP	MAX	
<b>POWER SUPPLY</b>							
$V_S$	Operating Voltage Range		25°C	2.5		5.5	V
$I_Q$	Quiescent Current/Amplifier		25°C		85	140	$\mu\text{A}$
PSRR	Power-Supply Rejection Ratio	$V_S = 2.5\text{V to } 5.5\text{V}$ , $V_{CM} = (V_-) + 0.5\text{V}$	25°C	70	75		dB
			-40°C to 125°C	64			
<b>INPUT</b>							
$V_{OS}$	Input Offset Voltage	$V_{CM} = 0\text{V to } 3.5\text{V}$	25°C	-4.5	0.8	4.5	mV
$V_{OS\ TC}$	Input Offset Voltage Average Drift	-40°C to 125°C			2		$\mu\text{V}/^\circ\text{C}$
$I_B$	Input Bias Current		25°C		10		$\mu\text{A}$
$I_{OS}$	Input Offset Current		25°C		10		$\mu\text{A}$
$V_{CM}$	Common-Mode Voltage Range	$V_S = 5.5\text{V}$	25°C	-0.1		5.6	V
CMRR	Common-Mode Rejection Ratio	$V_S = 5.5\text{V}$ , $V_{CM} = -0.1\text{V to } 4\text{V}$	25°C	65	85		dB
			-40°C to 125°C	62			
			25°C	58	80		
			-40°C to 125°C	56			
<b>OUTPUT</b>							
$A_{OL}$	Open-Loop Voltage Gain	$R_L = 2\text{k}\Omega$ , $V_O = 0.15\text{V to } 4.85\text{V}$	25°C	85	95		dB
			-40°C to 125°C	75			
			25°C	88	100		
			-40°C to 125°C	80			
	Output Swing From Rail	$R_L = 2\text{k}\Omega$ $R_L = 10\text{k}\Omega$	25°C		25		mV
					8		
$I_{OUT}$	Output Current Source		25°C		120		mA
<b>FREQUENCY RESPONSE</b>							
SR	Slew Rate		25°C		0.45		V/ $\mu\text{s}$
GBP	Gain-Bandwidth Product		25°C		1		MHz
PM	Phase Margin		25°C		64		°
$t_S$	Setting Time, 0.1%				1.3		$\mu\text{s}$
	Overload Recovery Time	$V_{IN} \cdot \text{Gain} \geq V_S$			2.3		$\mu\text{s}$
<b>NOISE</b>							
$e_n$	Input Voltage Noise Density	$f = 1\text{KHz}$	25°C		22		$\text{nV}/\sqrt{\text{Hz}}$
		$f = 10\text{KHz}$	25°C		20		$\text{nV}/\sqrt{\text{Hz}}$

### TYPICAL CHARACTERISTICS

At  $T_A = +25^\circ\text{C}$ ,  $V_S = 5\text{V}$ ,  $R_L = 10\text{k}\Omega$  connected to  $V_S/2$ ,  $V_{OUT} = V_S/2$ , unless otherwise noted.

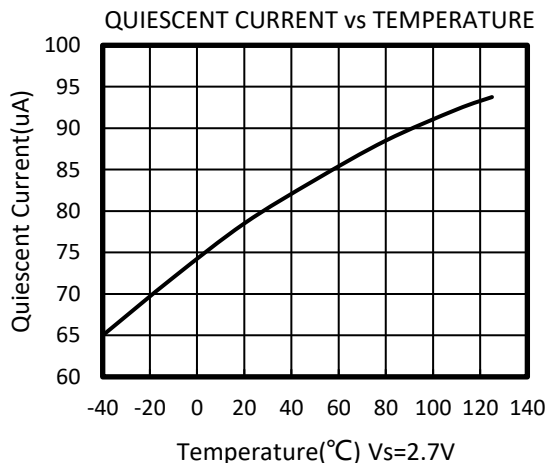
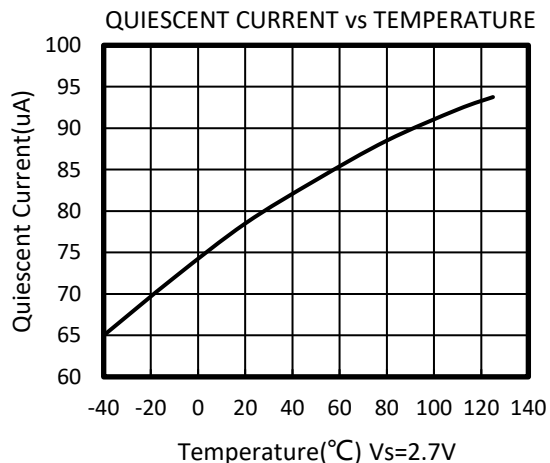
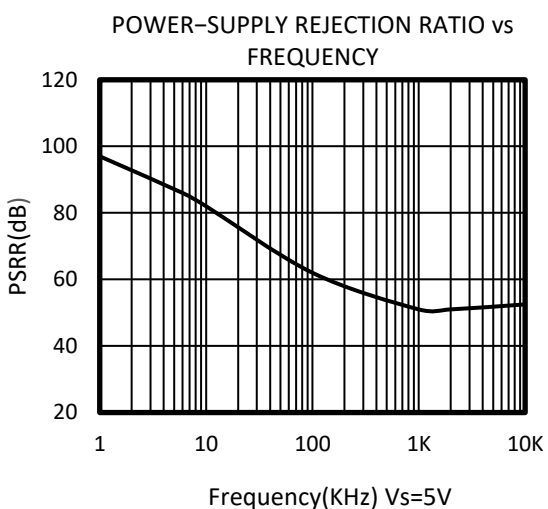
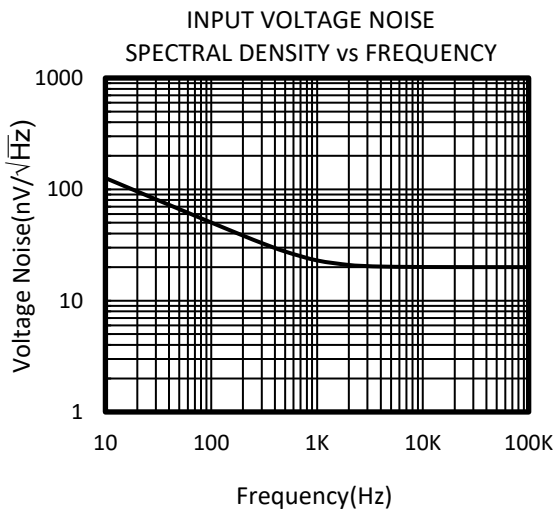
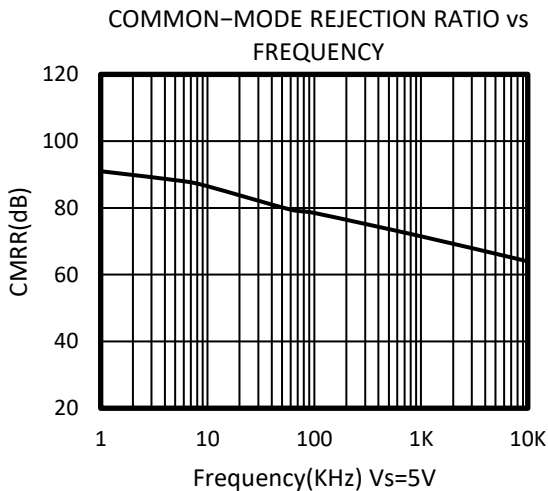
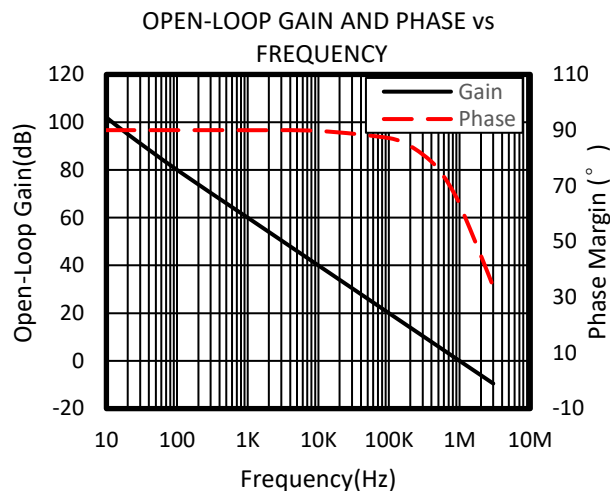

### TYPICAL CHARACTERISTICS

At  $T_A = +25^\circ\text{C}$ ,  $V_S = 5\text{V}$ ,  $R_L = 10\text{k}\Omega$  connected to  $V_S/2$ ,  $V_{OUT} = V_S/2$ , unless otherwise noted.

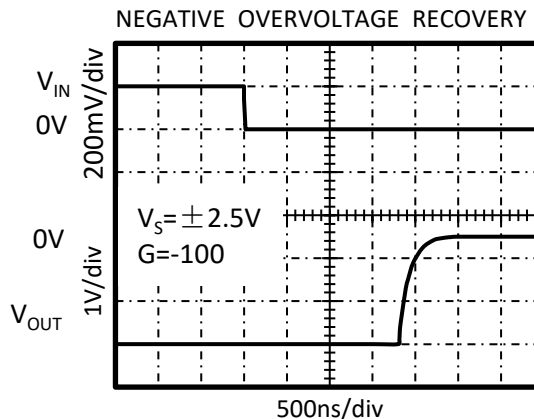
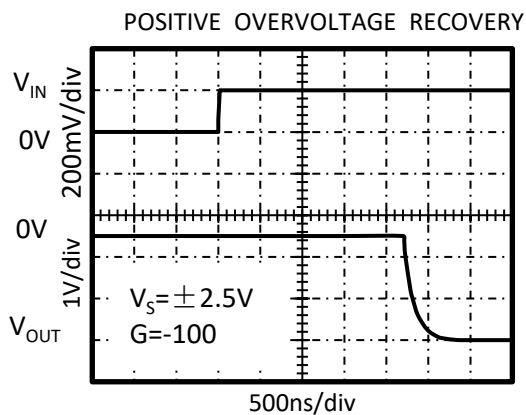
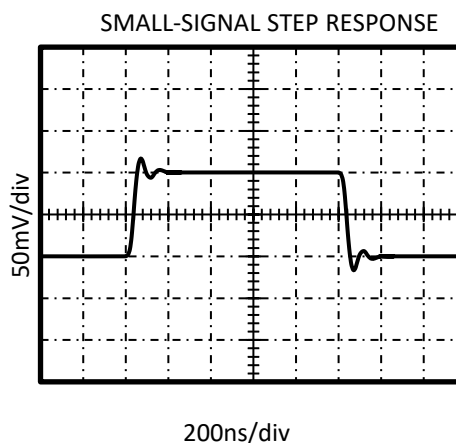
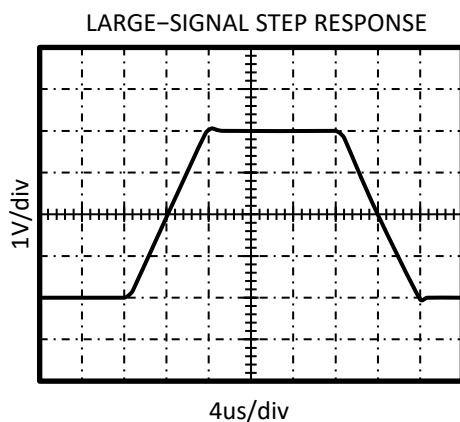
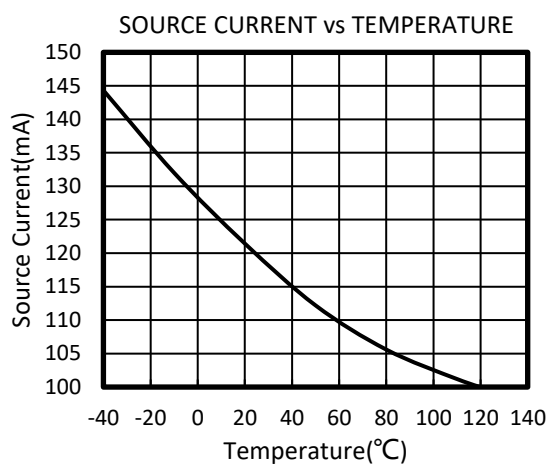
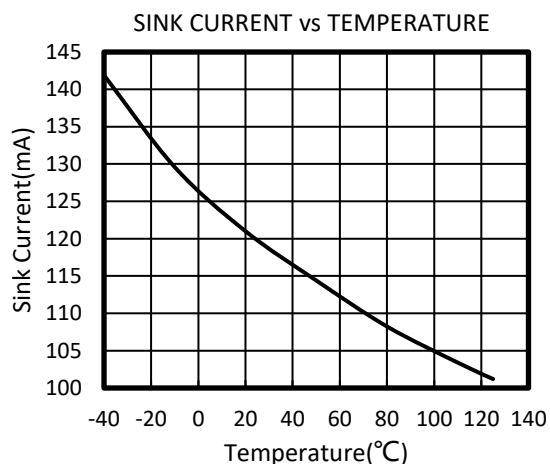

## APPLICATION NOTES

The RS321K, RS358K, RS324K are high precision, rail-to-rail operational amplifiers that can be run from a single-supply voltage 2.5V to 5.5V ( $\pm 1.25V$  to  $\pm 2.75V$ ). Supply voltages higher than 7V (absolute maximum) can permanently damage the amplifier.

Rail-to-rail input and output swing significantly increases dynamic range, especially in low-supply applications.

Good layout practice mandates use of a 0.1uF capacitor placed closely across the supply pins.

## LAYOUT GUIDELINS

Attention to good layout practices is always recommended. Keep traces short. When possible, use a PCB ground plane with surface-mount components placed as close to the device pins as possible. Place a 0.1uF capacitor closely across the supply pins.

These guidelines should be applied throughout the analog circuit to improve performance and provide benefits such as reducing the EMI susceptibility.

## INSTRUMENTATION AMPLIFIER

In the three-op amp, instrumentation amplifier configuration shown in Figure2,

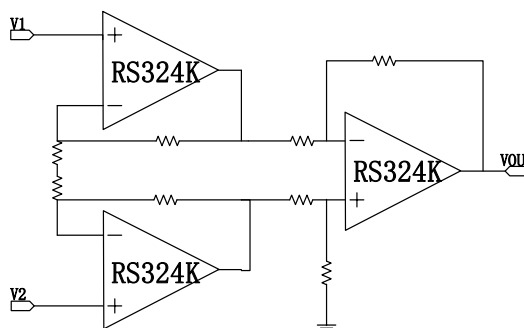

Figure2. Amplifier instrumentation amplifier

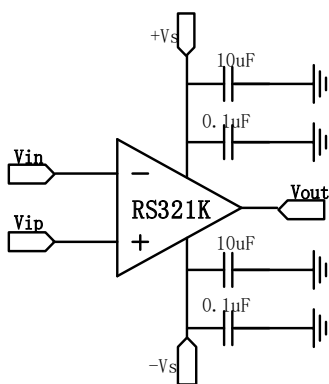
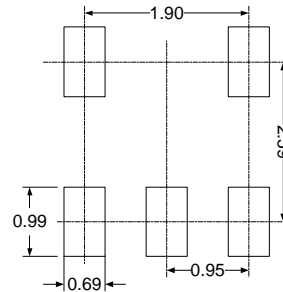
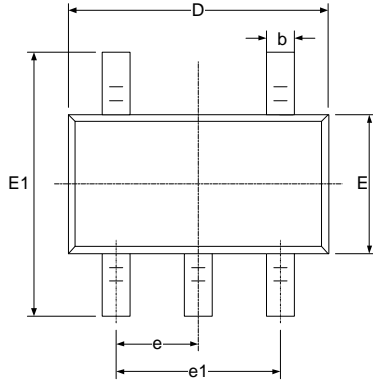

Figure1. Amplifier with Bypass Capacitors

# PACKAGE OUTLINE DIMENSIONS

## SOT23-5



**RECOMMENDED LAND PATTERN (Unit: mm)**

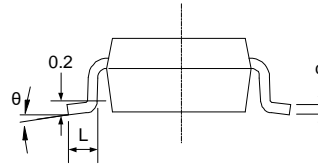
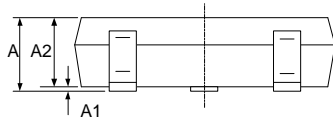

Symbol	Dimensions In Millimeters		Dimensions In Inches	
	Min	Max	Min	Max
A	1.050	1.250	0.041	0.049
A1	0.000	0.100	0.000	0.004
A2	1.050	1.150	0.041	0.045
b	0.300	0.500	0.012	0.020
c	0.100	0.200	0.004	0.008
D	2.820	3.020	0.111	0.119
E	1.500	1.700	0.059	0.067
E1	2.650	2.950	0.104	0.116
e	0.950(BSC)		0.037(BSC)	
e1	1.800	2.000	0.071	0.079
L	0.300	0.600	0.012	0.024
$\theta$	0°	8°	0°	8°

# SOT353(SC70-5)

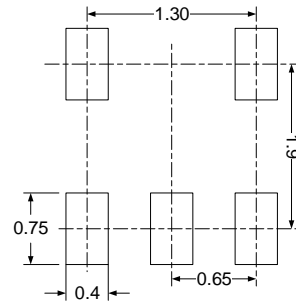
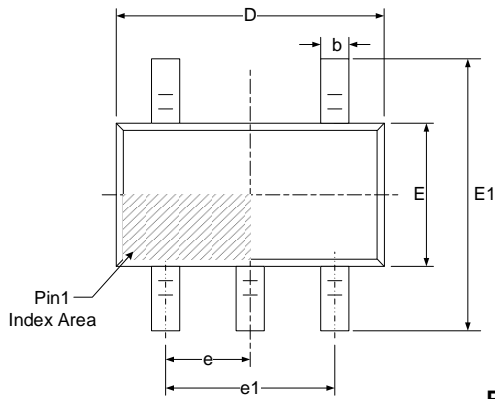
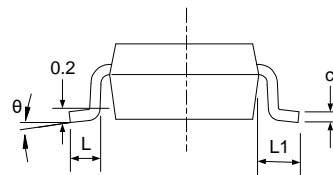
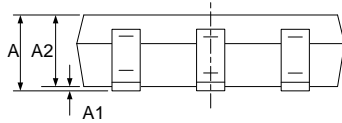
**RECOMMENDED LAND PATTERN (Unit: mm)**

Symbol	Dimensions In Millimeters		Dimensions In Inches	
	Min	Max	Min	Max
A	0.900	1.100	0.035	0.043
A1	0.000	0.100	0.000	0.004
A2	0.900	1.000	0.035	0.039
b	0.150	0.350	0.006	0.014
c	0.080	0.150	0.003	0.006
D	2.000	2.200	0.079	0.087
E	1.150	1.350	0.045	0.053
E1	2.150	2.450	0.085	0.096
e	0.650(BSC)		0.026(BSC)	
e1	1.300(BSC)		0.051(BSC)	
L	0.260	0.460	0.010	0.018
L1	0.525		0.021	
θ	0°	8°	0°	8°



# MSOP-8

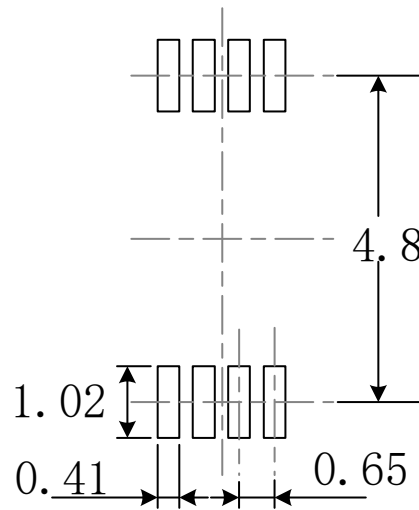
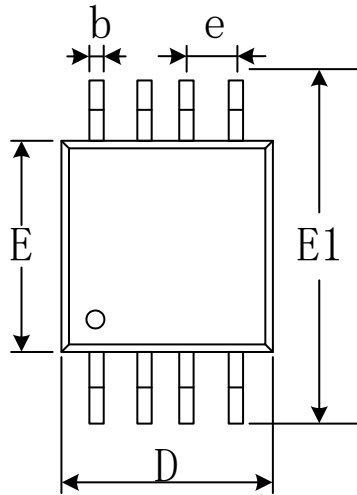

RECOMMENDED LAND PATTERN (Unit: mm)

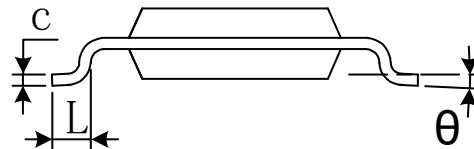
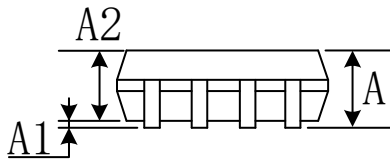

Symbol	Dimensions In Millimeters		Dimensions In Inches	
	Min	Max	Min	Max
A	0.820	1.100	0.032	0.043
A1	0.020	0.150	0.001	0.006
A2	0.750	0.950	0.030	0.037
b	0.250	0.380	0.010	0.015
c	0.090	0.230	0.004	0.009
D	2.900	3.100	0.114	0.122
e	0.650(BSC)		0.026(BSC)	
E	2.900	3.100	0.114	0.122
E1	4.750	5.050	0.187	0.199
L	0.400	0.800	0.016	0.031
θ	0°	6°	0°	6°

# TSSOP-8

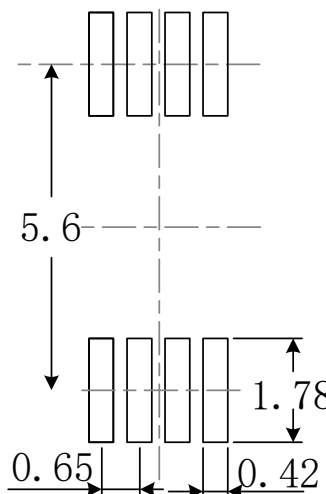
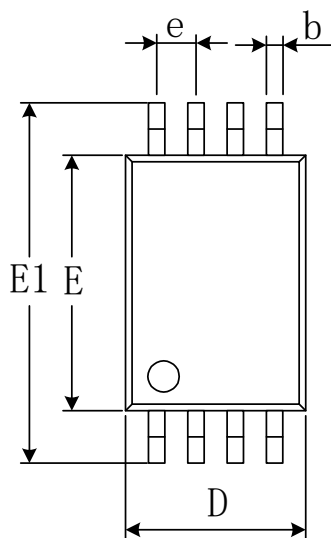

RECOMMENDED LAND PATTERN (Unit: mm)

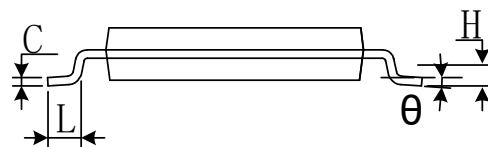
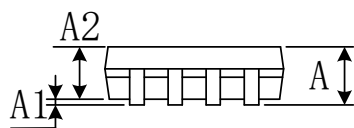

Symbol	Dimensions In Millimeters		Dimensions In Inches	
	Min	Max	Min	Max
A		1.200		0.047
A1	0.050	0.150	0.002	0.006
A2	0.800	1.050	0.031	0.041
b	0.190	0.300	0.007	0.012
c	0.090	0.200	0.004	0.008
D	2.900	3.100	0.114	0.122
E	4.300	4.500	0.169	0.177
E1	6.250	6.550	0.246	0.258
e	0.650(BSC)		0.026(BSC)	
L	0.500	0.700	0.020	0.028
H	0.25(TYP)		0.01(TYP)	
$\theta$	1°	7°	1°	7°

# TSSOP-14

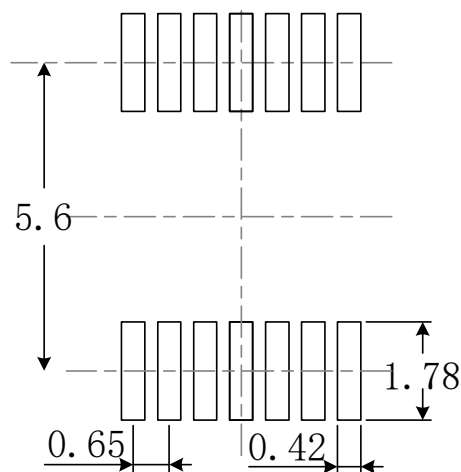
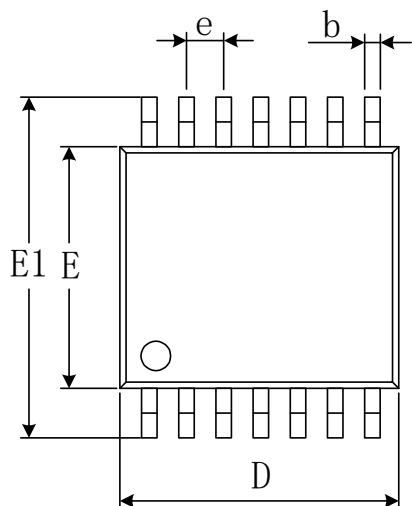
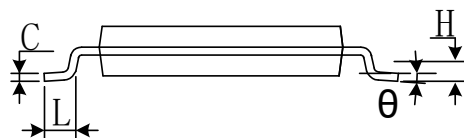
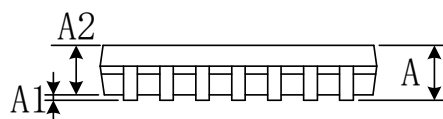

**RECOMMENDED LAND PATTERN** (Unit: mm)

Symbol	Dimensions In Millimeters		Dimensions In Inches	
	Min	Max	Min	Max
A		1.200		0.047
A1	0.050	0.150	0.002	0.006
A2	0.800	1.050	0.031	0.041
b	0.190	0.300	0.007	0.012
c	0.090	0.200	0.004	0.008
D	4.860	5.100	0.191	0.201
E	4.300	4.500	0.169	0.177
E1	6.250	6.550	0.246	0.258
e	0.650(BSC)		0.026(BSC)	
L	0.500	0.700	0.020	0.028
H	0.25(TYP)		0.01(TYP)	
$\theta$	1°	7°	1°	7°

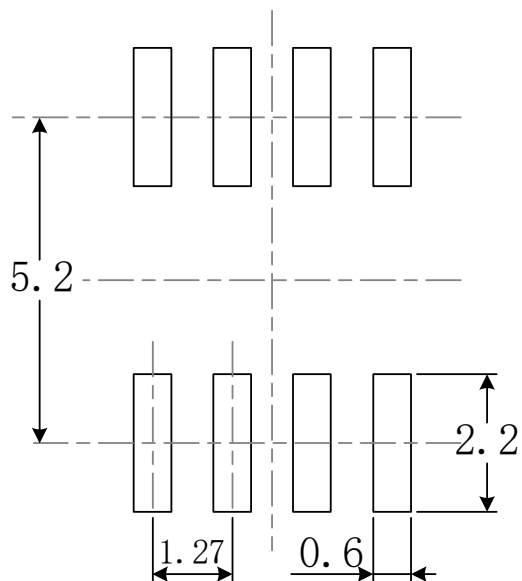
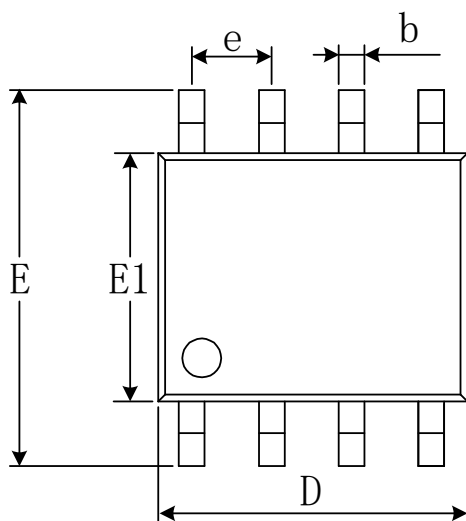
# SOIC-8(SOP8)

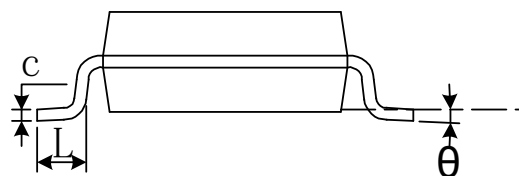
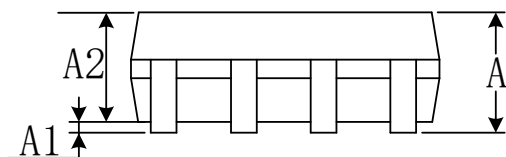

RECOMMENDED LAND PATTERN (Unit: mm)



Symbol	Dimensions In Millimeters		Dimensions In Inches	
	Min	Max	Min	Max
A	1.350	1.750	0.053	0.069
A1	0.100	0.250	0.004	0.010
A2	1.350	1.550	0.053	0.061
b	0.330	0.510	0.013	0.020
c	0.170	0.250	0.007	0.010
D	4.800	5.000	0.189	0.197
e	1.270(BSC)		0.050(BSC)	
E	5.800	6.200	0.228	0.244
E1	3.800	4.000	0.150	0.157
L	0.400	1.270	0.016	0.050
$\theta$	0°	8°	0°	8°

# SOIC-14(SOP14)

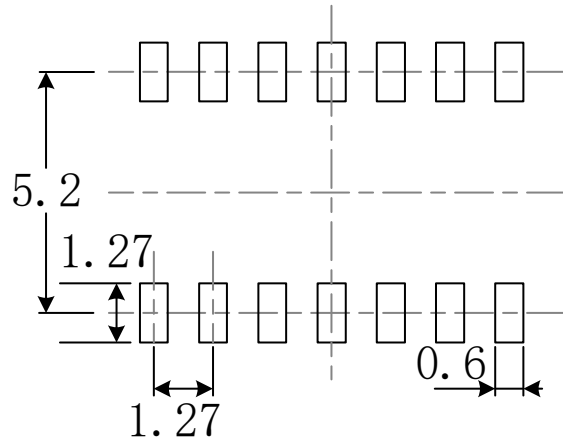
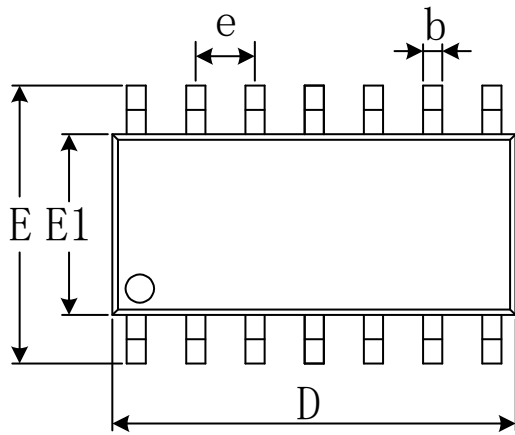

**RECOMMENDED LAND PATTERN** (Unit: mm)

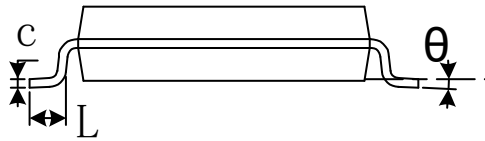
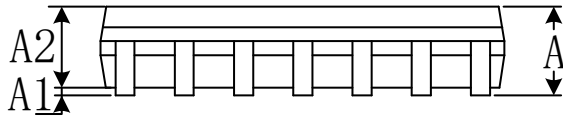

Symbol	Dimensions In Millimeters		Dimensions In Inches	
	Min	Max	Min	Max
A	1.350	1.750	0.053	0.069
A1	0.100	0.250	0.004	0.010
A2	1.350	1.550	0.053	0.061
b	0.310	0.510	0.012	0.020
c	0.100	0.250	0.004	0.010
D	8.450	8.850	0.333	0.348
e	1.270(BSC)		0.050(BSC)	
E	5.800	6.200	0.228	0.244
E1	3.800	4.000	0.150	0.157
L	0.400	1.270	0.016	0.050
$\theta$	0°	8°	0°	8°

# TDFN-3x3-8L

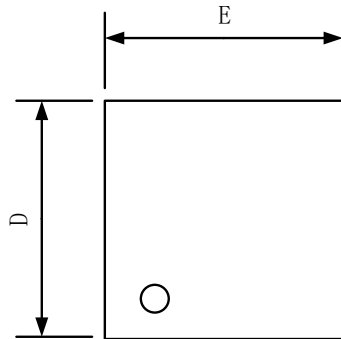

TOP VIEW

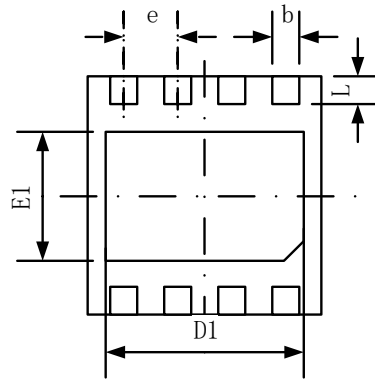

BOTTOM VIEW

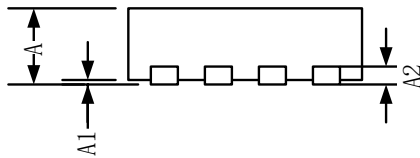

SIDE VIEW

Symbol	Dimensions In Millimeters		Dimensions In Inches	
	Min	Max	Min	Max
A	0.700	0.800	0.028	0.031
A1	0.000	0.050	0.000	0.002
A2	0.203		0.008	
b	0.300	0.400	0.012	0.016
D	2.900	3.100	0.114	0.122
D1	2.510	2.610	0.099	0.103
E	2.900	3.100	0.114	0.122
E1	1.550	1.650	0.061	0.065
e	0.650 TYP		0.026 TYP	
L	0.350	0.450	0.014	0.018