

## S9018 TRANSISTOR (NPN)

### FEATURES

AM/FM Amplifier, Local Oscillator of FM/VHF Tuner  
 High Current Gain Bandwidth Product  $f_T=1.1$  GHz (Typ)

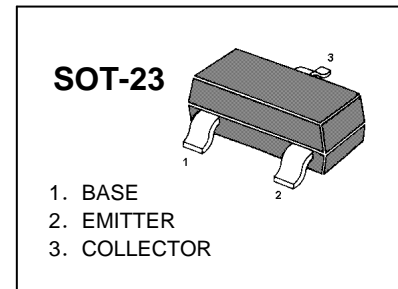

**MARKING : J8**

### MAXIMUM RATINGS ( $T_A=25^\circ\text{C}$ unless otherwise noted)

Symbol	Parameter	Value	Units
$V_{CBO}$	Collector-Base Voltage	30	V
$V_{CEO}$	Collector-Emitter Voltage	15	V
$V_{EBO}$	Emitter-Base Voltage	5	V
$I_C$	Collector Current -Continuous	50	mA
$P_C$	Collector Power Dissipation	200	mW
$T_j$	Junction Temperature	150	$^\circ\text{C}$
$T_{stg}$	Storage Temperature	-55-150	$^\circ\text{C}$

### ELECTRICAL CHARACTERISTICS ( $T_{amb}=25^\circ\text{C}$ unless otherwise specified)

Parameter	Symbol	Test conditions	MIN	TYP	MAX	UNIT
Collector-base breakdown voltage	$V_{(BR)CBO}$	$I_C=100\mu\text{A}$ , $I_E=0$	30			V
Collector-emitter breakdown voltage	$V_{(BR)CEO}$	$I_C=1\text{mA}$ , $I_B=0$	15			V
Emitter-base breakdown voltage	$V_{(BR)EBO}$	$I_E=100\mu\text{A}$ , $I_C=0$	5			V
Collector cut-off current	$I_{CBO}$	$V_{CB}=12\text{V}$ , $I_E=0$			0.05	$\mu\text{A}$
Collector cut-off current	$I_{CEO}$	$V_{CE}=12\text{V}$ , $I_B=0$			0.1	$\mu\text{A}$
Emitter cut-off current	$I_{EBO}$	$V_{EB}=3\text{V}$ , $I_C=0$			0.1	$\mu\text{A}$
DC current gain	$h_{FE(1)}$	$V_{CE}=5\text{V}$ , $I_C=1\text{mA}$	105		195	
Collector-emitter saturation voltage	$V_{CE(sat)}$	$I_C=10\text{mA}$ , $I_B=1\text{mA}$			0.5	V
Base-emitter saturation voltage	$V_{BE(sat)}$	$I_C=10\text{mA}$ , $I_B=1\text{mA}$			1.4	V
Transition frequency	$f_T$	$V_{CE}=5\text{V}$ , $I_C=5\text{mA}$ $f=400\text{MHz}$	600			MHz

## Typical Characteristics

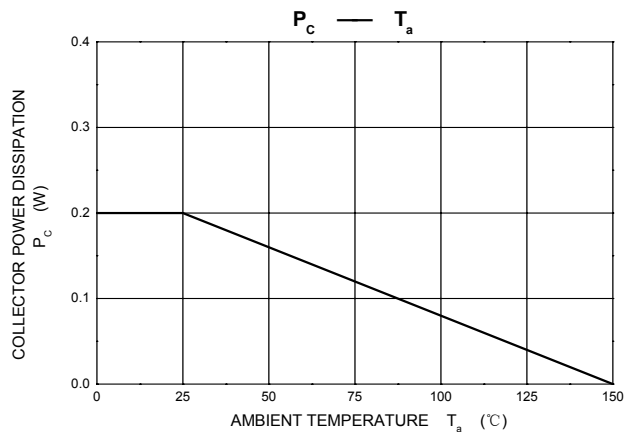
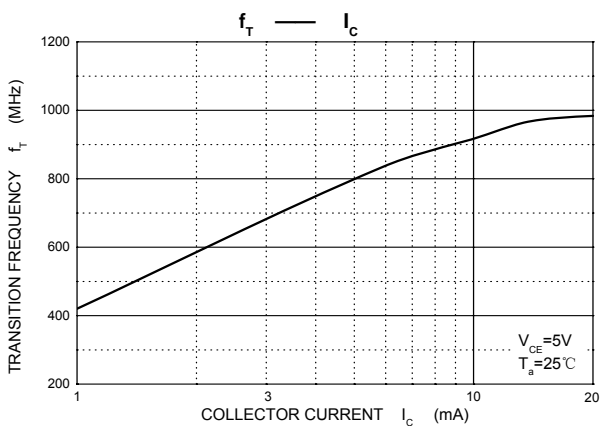
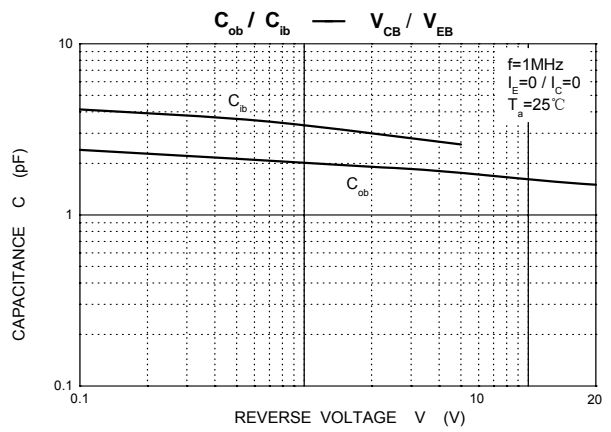
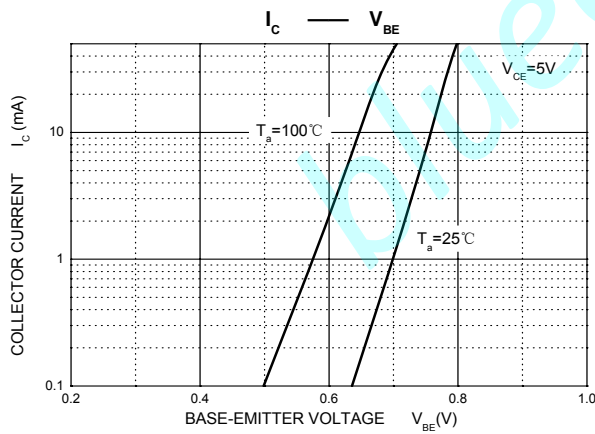
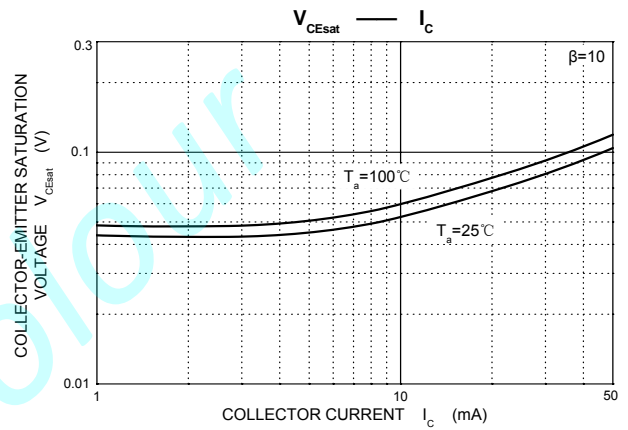
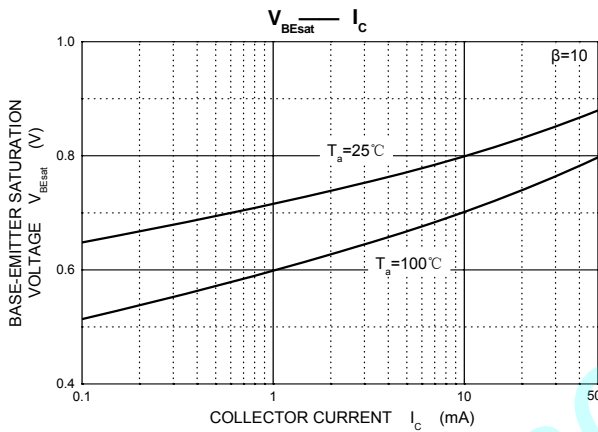
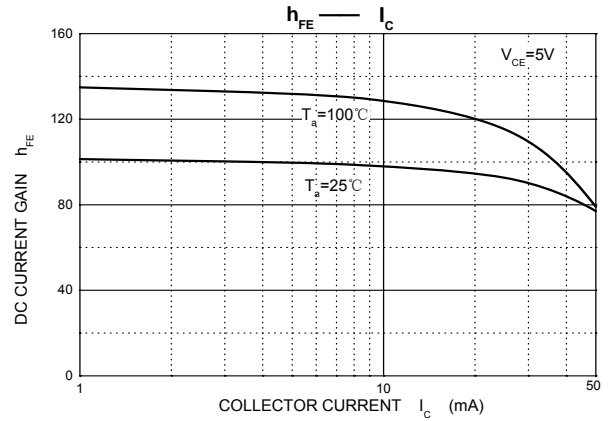
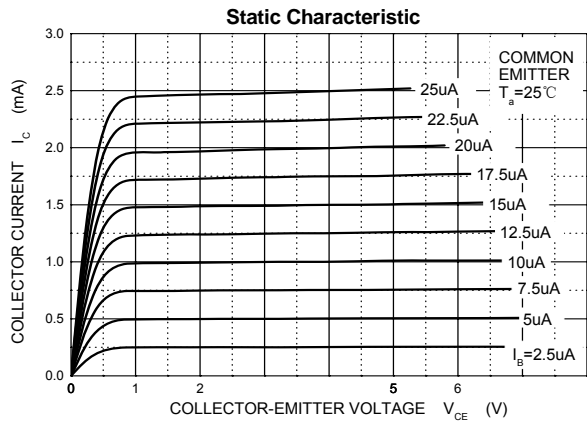

## PACKAGE OUTLINE

Plastic surface mounted package; 3 leads

SOT-23

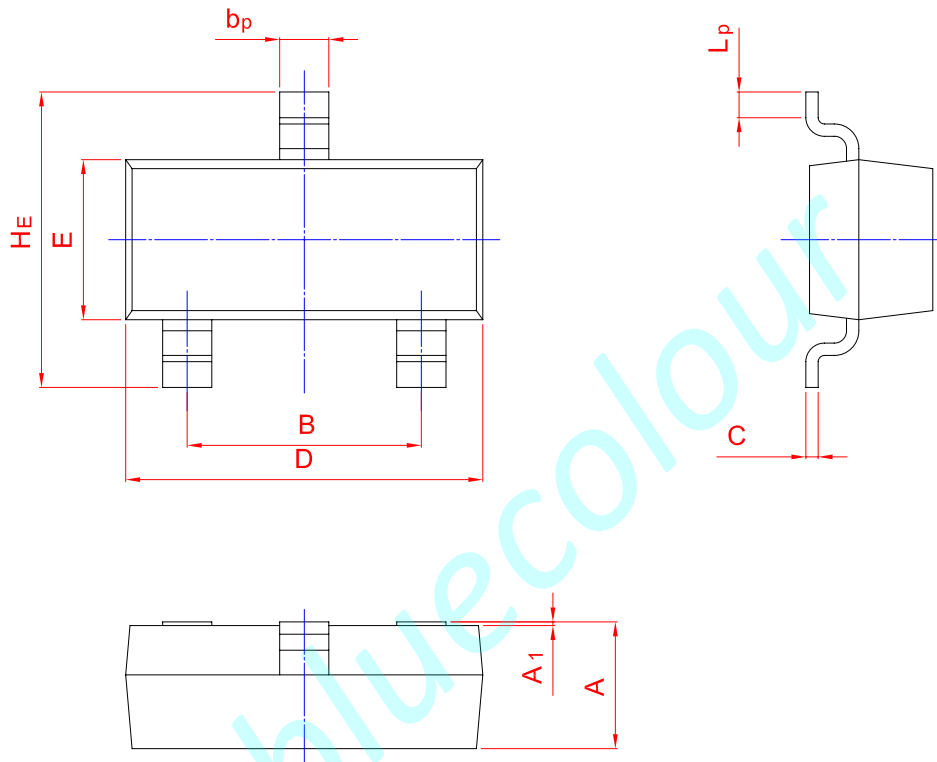
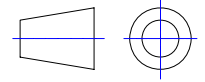

UNIT	A	B	bp	C	D	E	HE	A1	Lp
mm	1.40	2.04	0.50	0.19	3.10	1.65	3.00	0.100	0.50
	0.95	1.78	0.35	0.08	2.70	1.20	2.20	0.013	0.20