

TPS53353 High-Efficiency 20-A Synchronous Buck SWIFT™ Converter With Eco-mode™

1 Features

- Conversion Input Voltage Range: 1.5 V to 15 V
- VDD Input Voltage Range: 4.5 V to 25 V
- 92% Efficiency From 12 V to 1.5 V at 20 A
- Output Voltage Range: 0.6 V to 5.5 V
- 5-V LDO Output
- Supports Single-Rail Input
- Integrated Power MOSFETs With 20 A of Continuous Output Current
- Auto-Skip Eco-mode™ for Light-Load Efficiency
- < 10- μ A Shutdown Current
- D-CAP™ Mode With Fast Transient Response
- Selectable Switching Frequency From 250 kHz to 1 MHz With External Resistor
- Selectable Auto-Skip or PWM-Only Operation
- Built-in 1% 0.6-V Reference.
- 0.7-ms, 1.4-ms, 2.8-ms and 5.6-ms Selectable Internal Voltage Servo Soft-Start
- Integrated Boost Switch
- Precharged Start-up Capability
- Adjustable Overcurrent Limit With Thermal Compensation
- Overvoltage, Undervoltage, UVLO and Overtemperature Protection
- Supports All Ceramic Output Capacitors
- Open-Drain Power-Good Indication
- Incorporates NexFET™ Power Block Technology
- 22-Pin QFN Package With PowerPAD™
- For SWIFT™ Power Products Documentation, see <http://www.ti.com/swift>

2 Applications

- Server/Storage
- Workstations and Desktops
- Telecommunications Infrastructure

3 Description

TPS53353 is a D-CAP™ mode, 20-A synchronous switcher with integrated MOSFETs. It is designed for ease of use, low external component count, and space-conscious power systems.

This device features 5.5-m Ω / 2.2-m Ω integrated MOSFETs, accurate 1%, 0.6-V reference, and integrated boost switch. A sample of competitive features include: a conversion input voltage range from 1.5 V to 15 V, very low external component count, D-CAP™ mode control for super fast transient, auto-skip mode operation, internal soft-start control, selectable frequency, and no need for compensation.

The conversion input voltage ranges from 1.5 V to 15 V, the supply voltage range is from 4.5 V to 25 V, and the output voltage range is from 0.6 V to 5.5 V.

The device is available in 5-mm \times 6-mm, 22-pin QFN package and is specified from -40°C to 85°C.

Device Information⁽¹⁾

PART NUMBER	PACKAGE	BODY SIZE (NOM)
TPS53353	LSON-CLIP (22)	6.00 mm \times 5.00 mm

(1) For all available packages, see the orderable addendum at the end of the data sheet.

Simplified Application

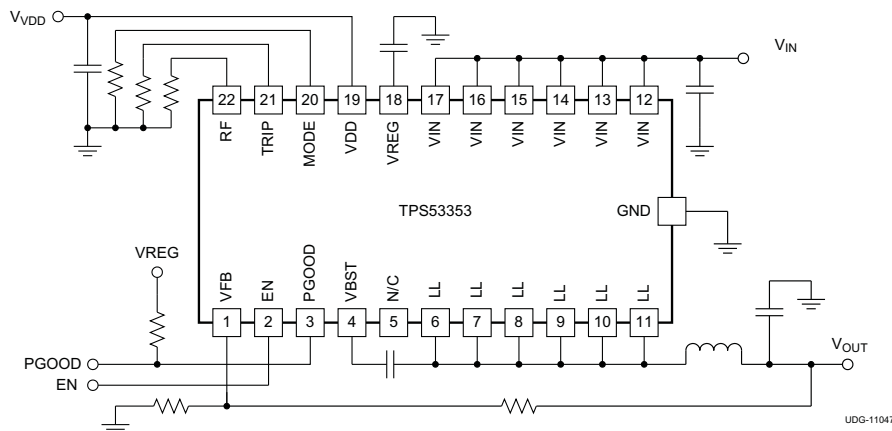

Table of Contents

1 Features	1	7.3 Feature Description.....	14
2 Applications	1	7.4 Device Functional Modes.....	17
3 Description	1	8 Application and Implementation	20
4 Revision History	2	8.1 Application Information.....	20
5 Pin Configuration and Functions	3	8.2 Typical Applications	20
6 Specifications	4	9 Power Supply Recommendations	27
6.1 Absolute Maximum Ratings	4	10 Layout	27
6.2 ESD Ratings.....	4	10.1 Layout Guidelines	27
6.3 Recommended Operating Conditions.....	4	10.2 Layout Example	28
6.4 Thermal Information	5	11 Device and Documentation Support	29
6.5 Electrical Characteristics.....	5	11.1 Trademarks	29
6.6 Typical Characteristics	7	11.2 Electrostatic Discharge Caution.....	29
7 Detailed Description	13	11.3 Glossary	29
7.1 Overview	13	12 Mechanical, Packaging, and Orderable Information	29
7.2 Functional Block Diagram	13		

4 Revision History

NOTE: Page numbers for previous revisions may differ from page numbers in the current version.

Changes from Revision B (February 2015) to Revision C

Page

- Changed the datasheet Title From: "TPS53353 High-Efficiency 20-A Synchronous Buck Converter With Eco-mode™" To: "TPS53353 High-Efficiency 20-A Synchronous Buck SWIFT™ Converter With Eco-mode™" 1
- Added *Features*: "For SWIFT™ Power Product Documentation..." 1

Changes from Revision A (April 2012) to Revision B

Page

- Added *Pin Configuration and Functions* section, *ESD Ratings* table, *Feature Description* section, *Device Functional Modes*, *Application and Implementation* section, *Power Supply Recommendations* section, *Layout* section, *Device and Documentation Support* section, and *Mechanical, Packaging, and Orderable Information* section 1

Changes from Original (AUGUST 2011) to Revision A

Page

- Changed conversion input voltage from "3 V" to "1.5 V"..... 1
- Changed VIN input voltage range minimum from "3 V" to "1.5 V" 3
- Changed to correct typographical error in THERMAL INFORMATION table..... 4
- Changed VIN (main supply) input voltage range minimum from "3 V" to "1.5 V" in [Recommended Operating Conditions](#)... 4
- Changed conversion input voltage range from "3 V" to "1.5" in [Overview](#) 13
- Added note to the [Feature Description](#)..... 14
- Changed "ripple injection capacitor" to "ripple injection resistor" in the last bullet of the section 27

5 Pin Configuration and Functions

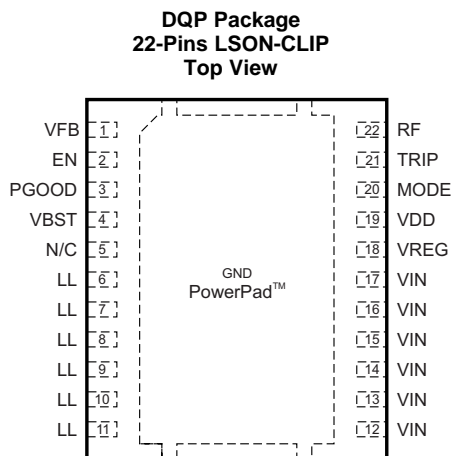

(1) N/C = no connection

Pin Functions

PIN		TYPE ⁽¹⁾	DESCRIPTION
NAME	NO.		
EN	2	I	Enable pin. Typical turnon threshold voltage is 1.2 V. Typical turnoff threshold voltage is 0.95 V.
GND		G	Ground and thermal pad of the device. Use proper number of vias to connect to ground plane.
LL	6	B	Output of converted power. Connect this pin to the output Inductor.
	7		
	8		
	9		
	10		
11			
MODE	20	I	Soft-start and Skip/CCM selection. Connect a resistor to select soft-start time using Table 3 . The soft-start time is detected and stored into internal register during start-up.
N/C	5		No connect.
PGOOD	3	O	Open drain power good flag. Provides 1-ms start-up delay after VFB falls in specified limits. When VFB goes out of the specified limits PGOOD goes low after a 2- μ s delay
RF	22	I	Switching frequency selection. Connect a resistor to GND or VREG to select switching frequency using Table 1 . The switching frequency is detected and stored during the startup.
TRIP	21	I	OCL detection threshold setting pin. $I_{TRIP} = 10 \mu A$ at room temperature, 4700 ppm/ $^{\circ}C$ current is sourced and set the OCL trip voltage as follows. $V_{OCL} = V_{TRIP} / 32$ ($V_{TRIP} \leq 1.2 V$, $V_{OCL} \leq 37.5 mV$)
VBST	4	P	Supply input for high-side FET gate driver (boost terminal). Connect capacitor from this pin to LL node. Internally connected to VREG via bootstrap MOSFET switch.
VDD	19	P	Controller power supply input. VDD input voltage range is from 4.5 V to 25 V.
VFB	1	I	Output feedback input. Connect this pin to Vout through a resistor divider.
VIN	12	P	Conversion power input. The conversion input voltage range is from 1.5 V to 15 V.
	13		
	14		
	15		
	16		
17			
VREG	18	P	5-V low drop out (LDO) output. Supplies the internal analog circuitry and driver circuitry.

(1) I=Input, O=Output, B=Bidirectional, P=Supply, G=Ground

6 Specifications

6.1 Absolute Maximum Ratings⁽¹⁾

		MIN	MAX	UNIT	
Input voltage range	VIN (main supply)	-0.3	25	V	
	VDD	-0.3	28		
	VBST	-0.3	32		
	VBST(with respect to LL)	-0.3	7		
	EN, TRIP, VFB, RF, MODE	-0.3	7		
Output voltage range	LL	DC	-2	25	V
		Pulse < 20ns, E=5 µJ	-7	27	
	PGOOD, VREG	-0.3	7		
	GND	-0.3	0.3		
Source/Sink current	VBST	50		mA	
Operating free-air temperature, T _A		-40	85	°C	
Junction temperature, T _J		-40	150		
Lead temperature 1,6 mm (1/16 inch) from case for 10 seconds			300		
Storage temperature, T _{stg}		-55	150	°C	

(1) Stresses beyond those listed under Absolute Maximum Ratings may cause permanent damage to the device. These are stress ratings only and functional operation of the device at these or any other conditions beyond those indicated under [Recommended Operating Conditions](#) is not implied. Exposure to absolute-maximum-rated conditions for extended periods may affect device reliability.

6.2 ESD Ratings

		VALUE	UNIT
V _(ESD) Electrostatic discharge	Human-body model (HBM), per ANSI/ESDA/JEDEC JS-001 ⁽¹⁾	2000	V
	Charged-device model (CDM), per JEDEC specification JESD22-C101 ⁽²⁾	500	

(1) JEDEC document JEP155 states that 500-V HBM allows safe manufacturing with a standard ESD control process.

(2) JEDEC document JEP157 states that 250-V CDM allows safe manufacturing with a standard ESD control process.

6.3 Recommended Operating Conditions

over operating free-air temperature range (unless otherwise noted)

		MIN	MAX	UNIT
Input voltage range	VIN (main supply)	1.5	15	V
	VDD	4.5	25	
	VBST	4.5	28	
	VBST(with respect to LL)	4.5	6.5	
	EN, TRIP, VFB, RF, MODE	-0.1	6.5	
Output voltage range	LL	-1	22	V
	PGOOD, VREG	-0.1	6.5	
Junction temperature range, T _J		-40	125	°C

6.4 Thermal Information

THERMAL METRIC ⁽¹⁾		TPS53353	UNIT
		DQP (LSON-CLIP)	
		22 PINS	
θ_{JA}	Junction-to-ambient thermal resistance	27.2	°C/W
θ_{JCTop}	Junction-to-case (top) thermal resistance	17.1	
θ_{JB}	Junction-to-board thermal resistance	5.9	
ψ_{JT}	Junction-to-top characterization parameter	0.8	
ψ_{JB}	Junction-to-board characterization parameter	5.8	
θ_{JCbott}	Junction-to-case (bottom) thermal resistance	1.2	

(1) For more information about traditional and new thermal metrics, see the *Semiconductor and IC Package Thermal Metrics* application report (SPRA953).

6.5 Electrical Characteristics

Over recommended free-air temperature range, $V_{VDD} = 12\text{ V}$ (unless otherwise noted)

PARAMETER		CONDITIONS	MIN	TYP	MAX	UNIT
SUPPLY CURRENT						
V_{VIN}	VIN pin power conversion input voltage		1.5		15	V
V_{VDD}	Supply input voltage		4.5		25	V
$I_{VIN(leak)}$	VIN pin leakage current	$V_{EN} = 0\text{ V}$			1	μA
I_{VDD}	VDD supply current	$T_A = 25^\circ\text{C}$, No load, $V_{EN} = 5\text{ V}$, $V_{VFB} = 0.630\text{ V}$		420	590	μA
I_{VDDSDN}	VDD shutdown current	$T_A = 25^\circ\text{C}$, No load, $V_{EN} = 0\text{ V}$			10	μA
INTERNAL REFERENCE VOLTAGE						
V_{VFB}	VFB regulation voltage	CCM condition ⁽¹⁾		0.6		V
V_{VFB}	VFB regulation voltage	$T_A = 25^\circ\text{C}$	0.597	0.6	0.603	V
		$0^\circ\text{C} \leq T_A \leq 85^\circ\text{C}$	0.5952	0.6	0.6048	
		$-40^\circ\text{C} \leq T_A \leq 85^\circ\text{C}$	0.594	0.6	0.606	
I_{VFB}	VFB input current	$V_{VFB} = 0.630\text{ V}$, $T_A = 25^\circ\text{C}$		0.01	0.2	μA
LDO OUTPUT						
V_{VREG}	LDO output voltage	$0\text{ mA} \leq I_{VREG} \leq 30\text{ mA}$	4.77	5	5.36	V
I_{VREG}	LDO output current ⁽¹⁾	Maximum current allowed from LDO			30	mA
V_{DO}	Low drop out voltage	$V_{VDD} = 4.5\text{ V}$, $I_{VREG} = 30\text{ mA}$			230	mV
BOOT STRAP SWITCH						
V_{FBST}	Forward voltage	$V_{VREG-VBST}$, $I_F = 10\text{ mA}$, $T_A = 25^\circ\text{C}$		0.1	0.2	V
I_{VBSTLK}	VBST leakage current	$V_{VBST} = 23\text{ V}$, $V_{SW} = 17\text{ V}$, $T_A = 25^\circ\text{C}$		0.01	1.5	μA
DUTY AND FREQUENCY CONTROL						
$t_{OFF(min)}$	Minimum off time	$T_A = 25^\circ\text{C}$	150	260	400	ns
$t_{ON(min)}$	Minimum on time	$V_{IN} = 17\text{ V}$, $V_{OUT} = 0.6\text{ V}$, $R_{RF} = 39\text{ k}\Omega$, $T_A = 25^\circ\text{C}$ ⁽¹⁾		35		ns
SOFT START						
t_{SS}	Internal soft-start time from $V_{OUT} = 0\text{ V}$ to 95% of V_{OUT}	$R_{MODE} = 39\text{ k}\Omega$		0.7		ms
		$R_{MODE} = 100\text{ k}\Omega$		1.4		
		$R_{MODE} = 200\text{ k}\Omega$		2.8		
		$R_{MODE} = 470\text{ k}\Omega$		5.6		
INTERNAL MOSFETs						
$R_{DS(on)H}$	High-side MOSFET on-resistance	$T_A = 25^\circ\text{C}$		5.5		m Ω
$R_{DS(on)L}$	Low-side MOSFET on-resistance	$T_A = 25^\circ\text{C}$		2.2		

(1) Ensured by design. Not production tested.

Electrical Characteristics (continued)

 Over recommended free-air temperature range, $V_{DD} = 12\text{ V}$ (unless otherwise noted)

PARAMETER		CONDITIONS	MIN	TYP	MAX	UNIT
POWERGOOD						
V_{THPG}	PG threshold	PG in from lower	92.5%	95%	98.5%	
		PG in from higher	107.5%	110%	112.5%	
		PG hysteresis	2.5%	5%	7.5%	
R_{PG}	PG transistor on-resistance		15	30	55	Ω
t_{PGDEL}	PG delay	Delay for PG in	0.8	1	1.2	ms
LOGIC THRESHOLD AND SETTING CONDITIONS						
V_{EN}	EN Voltage	Enable	1.8			V
		Disable	0.6			
I_{EN}	EN Input current	$V_{EN} = 5\text{ V}$	1			μA
f_{SW}	Switching frequency	$R_{RF} = 0\ \Omega$ to GND, $T_A = 25^\circ\text{C}^{(2)}$	200	250	300	kHz
		$R_{RF} = 187\text{ k}\Omega$ to GND, $T_A = 25^\circ\text{C}^{(2)}$	250	300	350	
		$R_{RF} = 619\text{ k}\Omega$, to GND, $T_A = 25^\circ\text{C}^{(2)}$	350	400	450	
		$R_{RF} = \text{Open}$, $T_A = 25^\circ\text{C}^{(2)}$	450	500	550	
		$R_{RF} = 866\text{ k}\Omega$ to VREG, $T_A = 25^\circ\text{C}^{(2)}$	580	650	720	
		$R_{RF} = 309\text{ k}\Omega$ to VREG, $T_A = 25^\circ\text{C}^{(2)}$	670	750	820	
		$R_{RF} = 124\text{ k}\Omega$ to VREG, $T_A = 25^\circ\text{C}^{(2)}$	770	850	930	
		$R_{RF} = 0\ \Omega$ to VREG, $T_A = 25^\circ\text{C}^{(2)}$	880	970	1070	
PROTECTION: CURRENT SENSE						
I_{TRIP}	TRIP source current	$V_{TRIP} = 1\text{ V}$, $T_A = 25^\circ\text{C}$	9.4	10	10.6	μA
TC_{ITRIP}	TRIP current temperature coefficient	On the basis of $25^\circ\text{C}^{(1)}$	4700			ppm/ $^\circ\text{C}$
V_{TRIP}	Current limit threshold setting range	$V_{TRIP-GND}$	0.4		1.2	V
V_{OCL}	Current limit threshold	$V_{TRIP} = 1.2\text{ V}$	32	37.5	43	mV
		$V_{TRIP} = 0.4$	7.5	12.5	17.5	
V_{OCLN}	Negative current limit threshold	$V_{TRIP} = 1.2\text{ V}$	-160	-150	-140	mV
		$V_{TRIP} = 0.4\text{ V}$	-58	-50	-42	
V_{AZCADJ}	Auto zero cross adjustable range	Positive	3	15		mV
		Negative		-15	-3	
PROTECTION: UVP and OVP						
V_{OVP}	OVP trip threshold	OVP detect	115%	120%	125%	
t_{OVPDEL}	OVP propropagation delay	VFB delay with 50-mV overdrive	1			μs
V_{UVP}	Output UVP trip threshold	UVP detect	65%	70%	75%	
t_{UVPDEL}	Output UVP propropagation delay		0.8	1	1.2	ms
t_{UVPEN}	Output UVP enable delay	From enable to UVP workable	1.8	2.6	3.2	ms
UVLO						
V_{UVVREG}	VREG UVLO threshold	Wake up	4	4.2	4.33	V
		Hysteresis	0.25			
THERMAL SHUTDOWN						
T_{SDN}	Thermal shutdown threshold	Shutdown temperature ⁽¹⁾	145			$^\circ\text{C}$
		Hysteresis ⁽¹⁾	10			

 (2) Not production tested. Test condition is $V_{IN} = 12\text{ V}$, $V_{OUT} = 1.1\text{ V}$, $I_{OUT} = 10\text{ A}$ using application circuit shown in [Figure 38](#).

6.6 Typical Characteristics

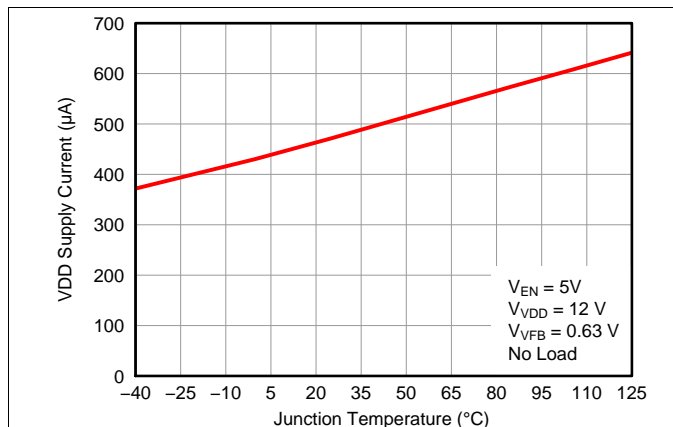

Figure 1. VDD Supply Current vs. Junction Temperature

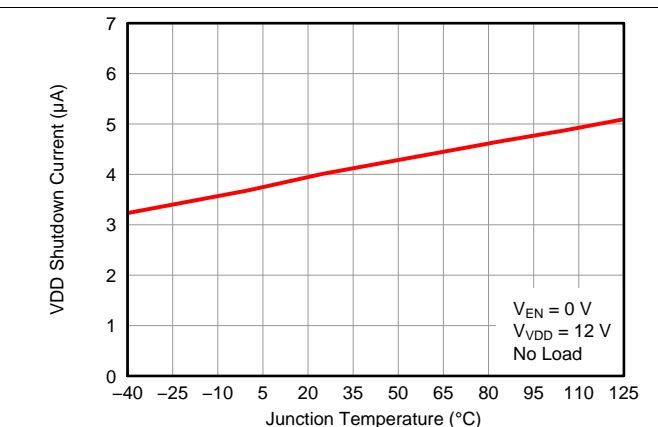

Figure 2. VDD Shutdown Current vs. Junction Temperature

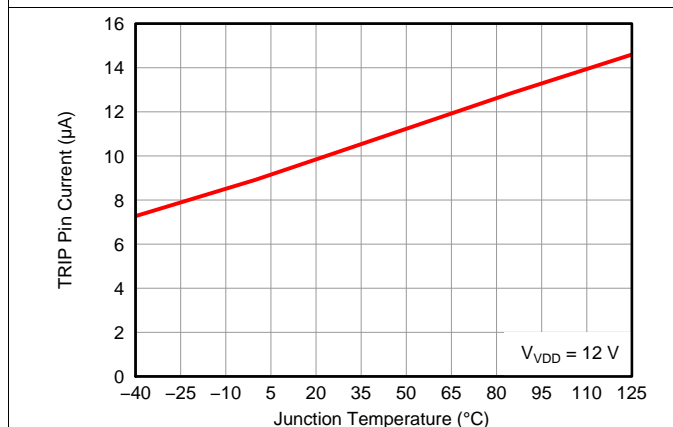

Figure 3. TRIP Pin Current vs. Junction Temperature

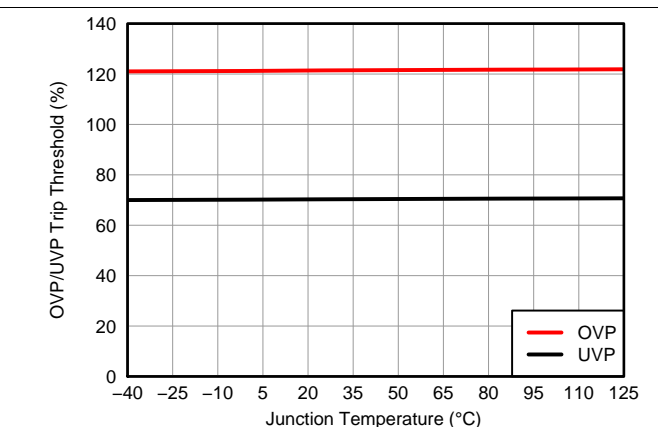

Figure 4. OVP/UVP Trip Threshold vs. Junction Temperature

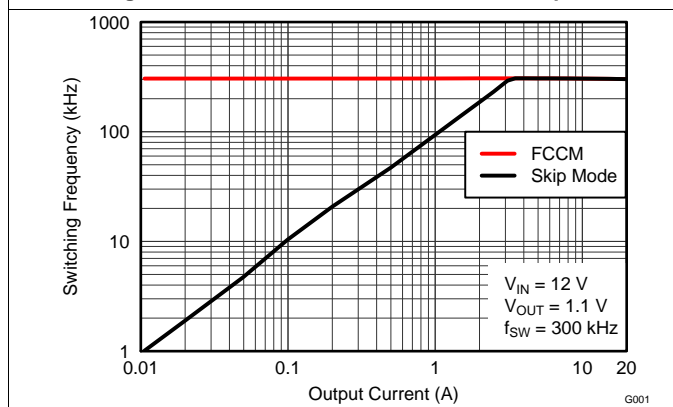

Figure 5. Switching Frequency vs. Output Current

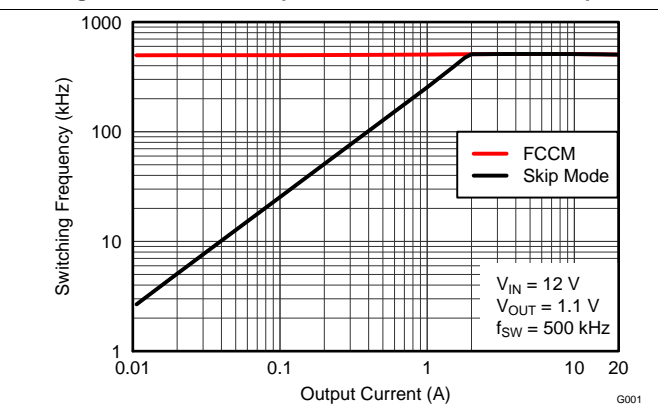

Figure 6. Switching Frequency vs. Output Current

Typical Characteristics (continued)

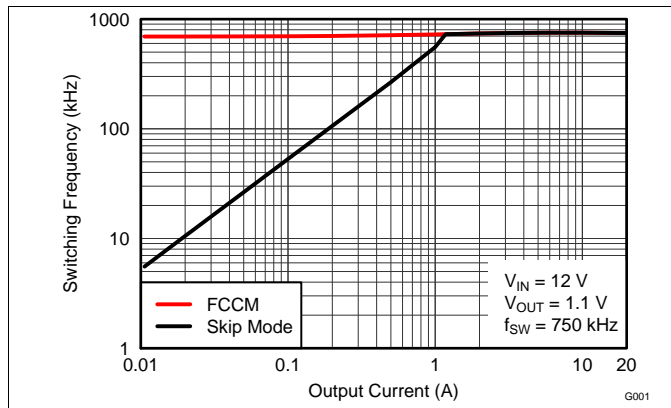

Figure 7. Switching Frequency vs. Output Current

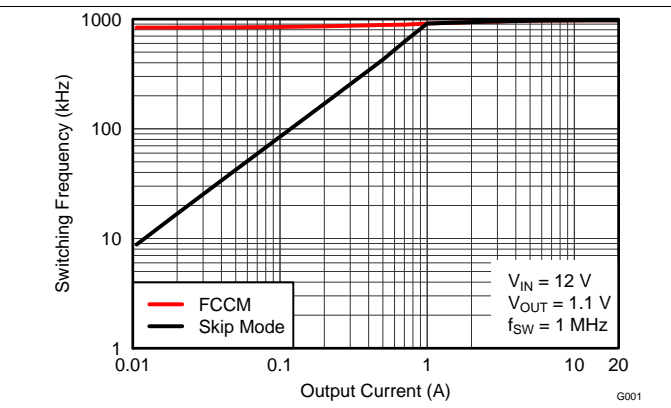

Figure 8. Switching Frequency vs. Output Current

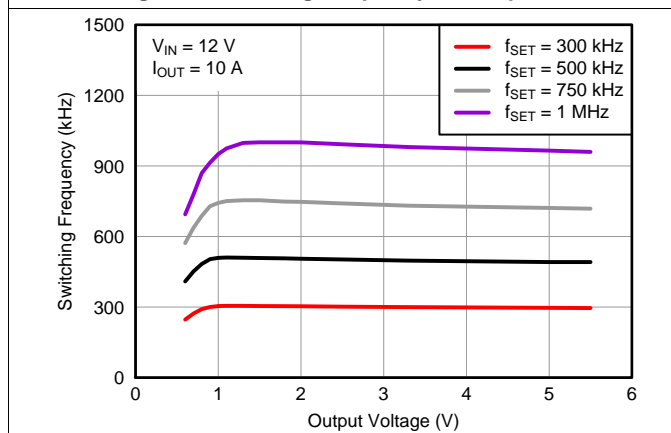

Figure 9. Switching Frequency vs. Output Voltage

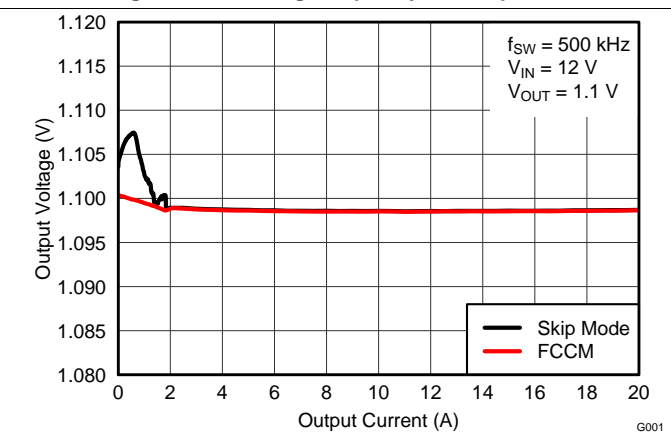

Figure 10. Output Voltage vs. Output Current

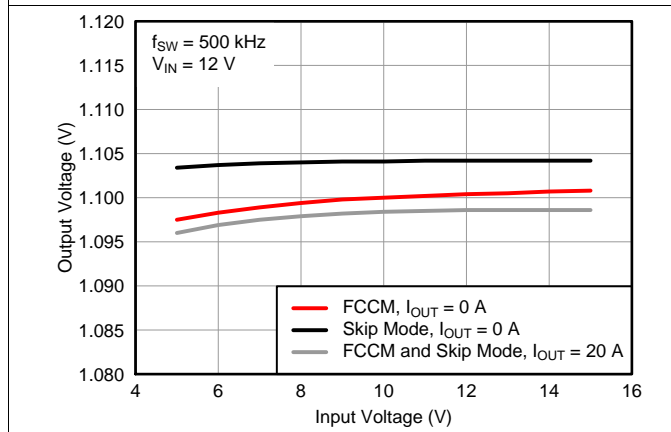

Figure 11. Output Voltage vs. Input Voltage

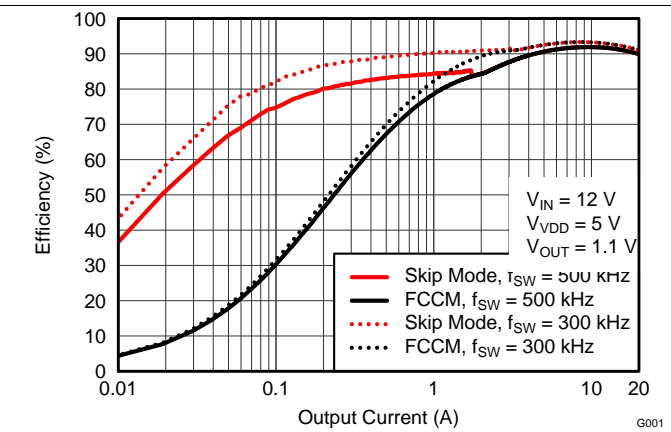

Figure 12. Efficiency vs. Output Current

Typical Characteristics (continued)

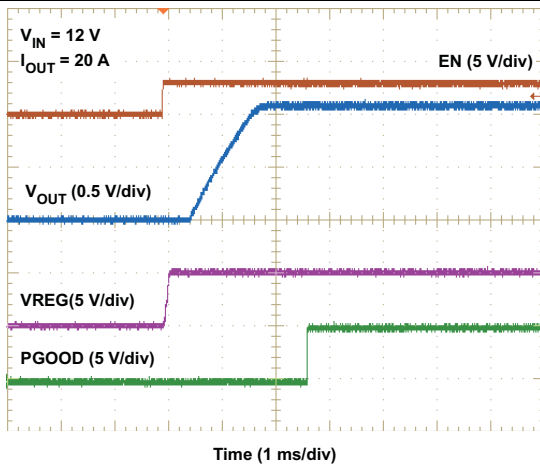

Figure 13. Start-Up Waveforms

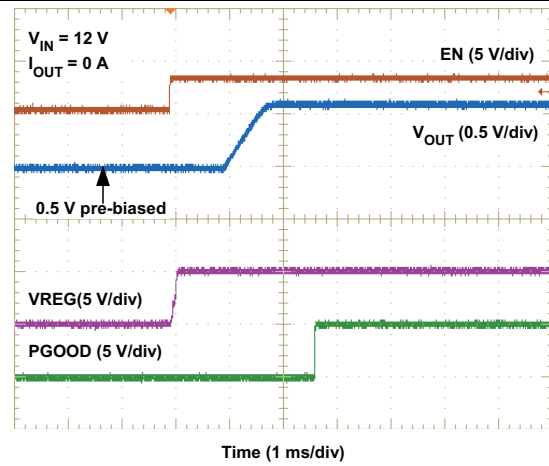

Figure 14. Prebias Start-Up Waveforms

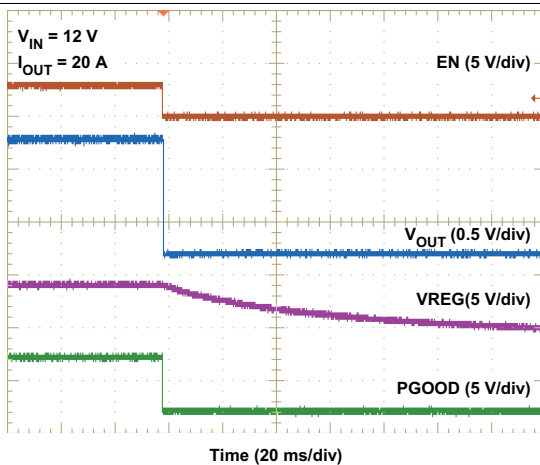

Figure 15. Shutdown Waveforms

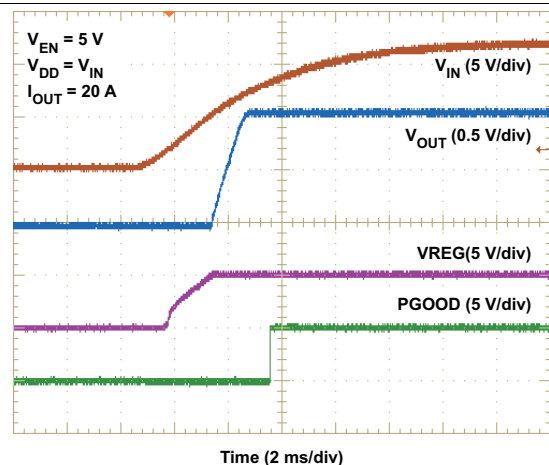

Figure 16. UVLO Start-Up Waveforms

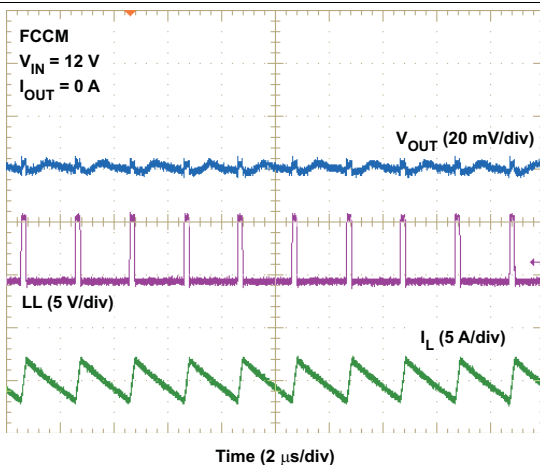

Figure 17. 1.1-V Output FCCM Mode Steady-State Operation

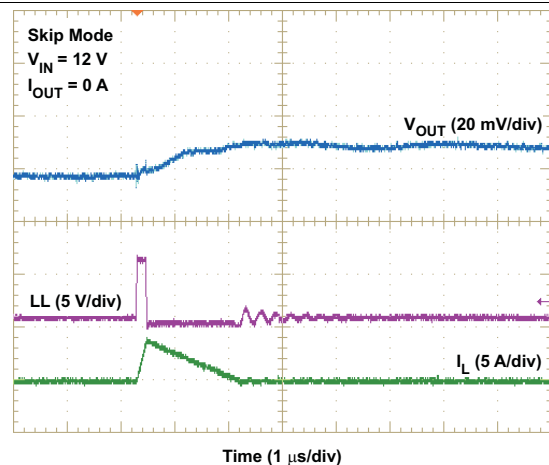

Figure 18. 1.1-V Output Skip Mode Steady-State Operation

Typical Characteristics (continued)

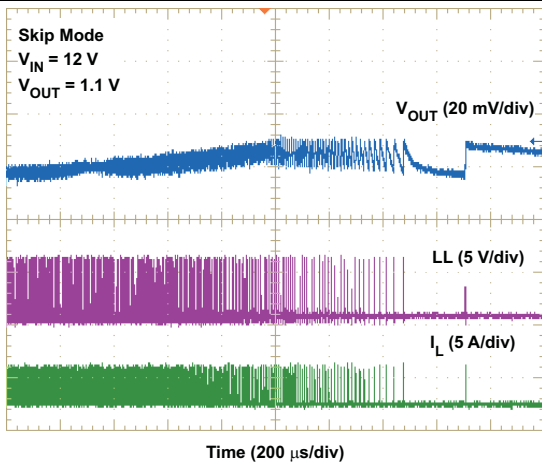

Figure 19. CCM-to-DCM Transition Waveforms

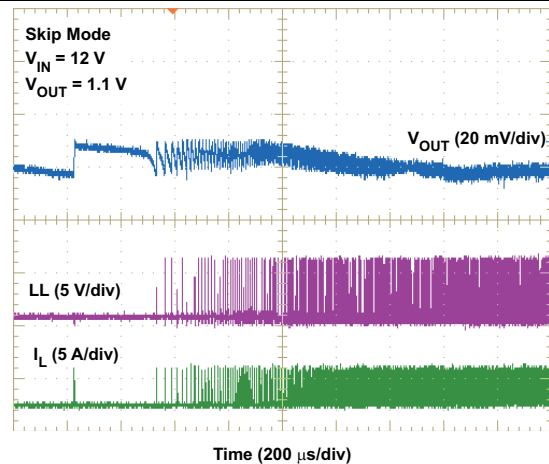

Figure 20. DCM-to-CCM Transition Waveforms

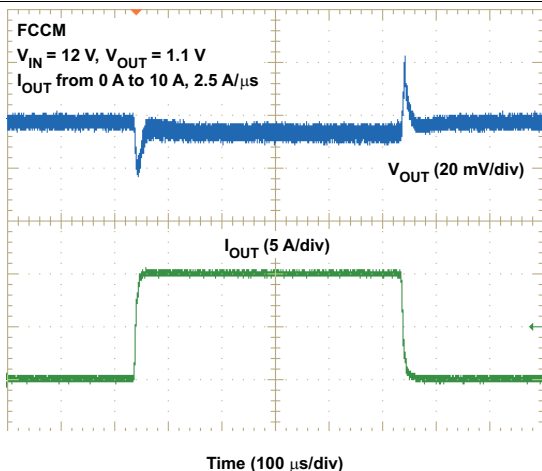

Figure 21. FCCM Load Transient

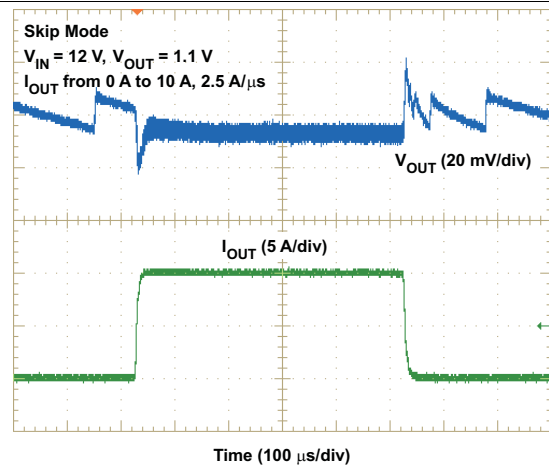

Figure 22. Skip Mode Load Transient

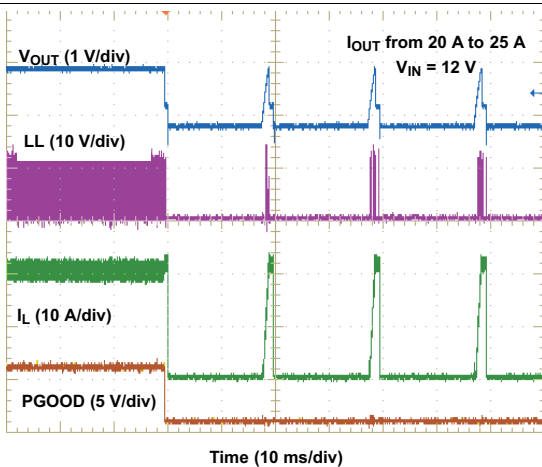

Figure 23. Overcurrent Protection Waveforms

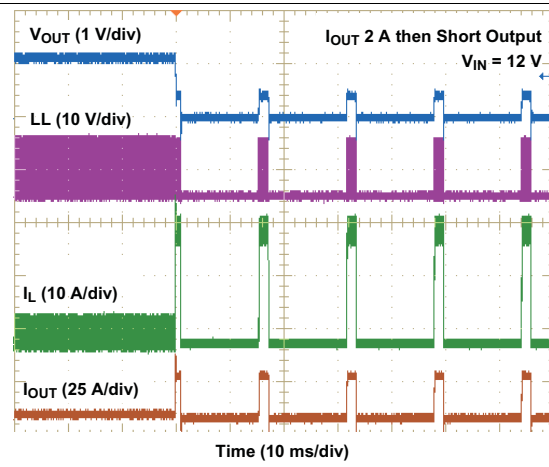

Figure 24. Output Short-Circuit Protection Waveforms

Typical Characteristics (continued)

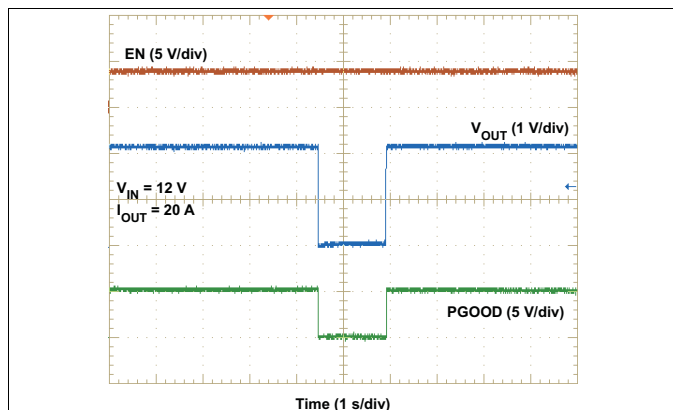

Figure 25. Overtemperature Protection Waveforms

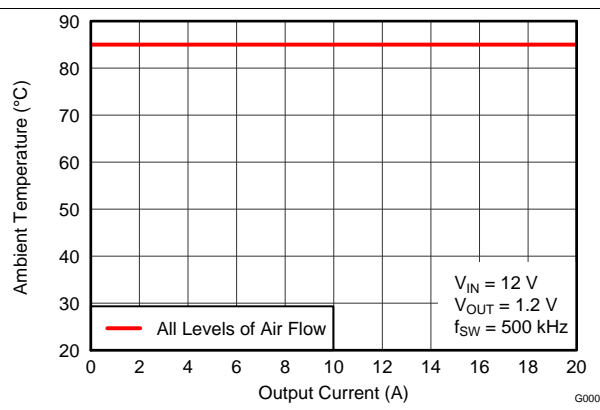

Figure 26. Safe Operating Area

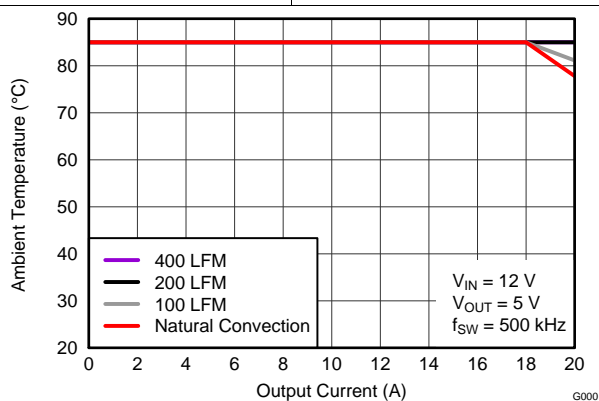

Figure 27. Safe Operating Area

For $V_{OUT} = 5\text{ V}$, an SC5026-1R0 inductor is used. For $1 \leq V_{OUT} \leq 3.3\text{ V}$, a PA0513.441 inductor is used

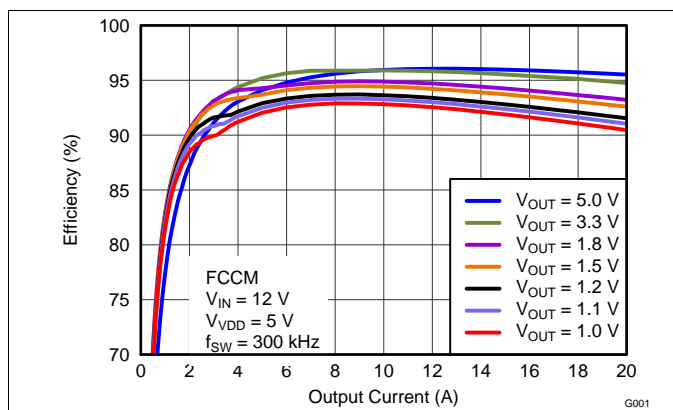

Figure 28. Efficiency vs Output Current

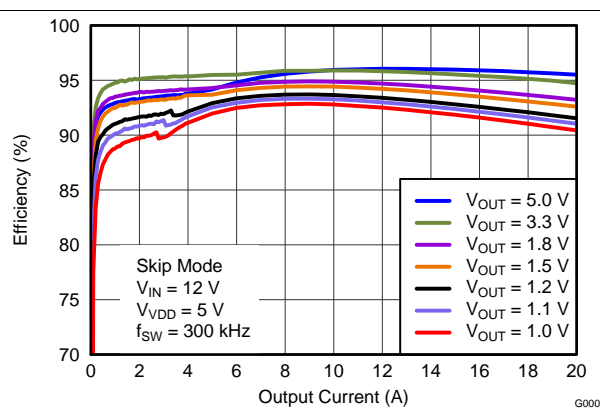

Figure 29. Efficiency vs Output Current

Typical Characteristics (continued)

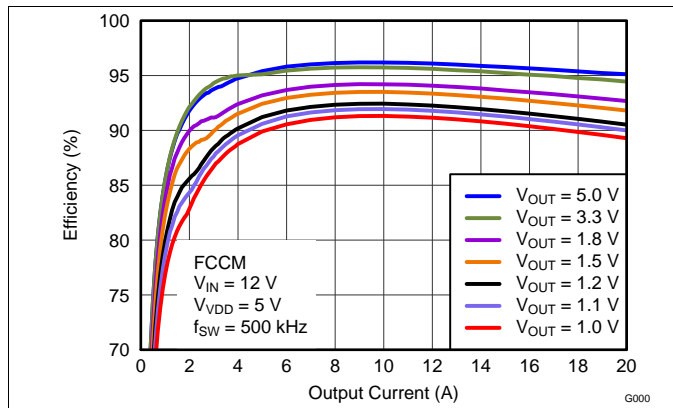

Figure 30. Efficiency vs Output Current

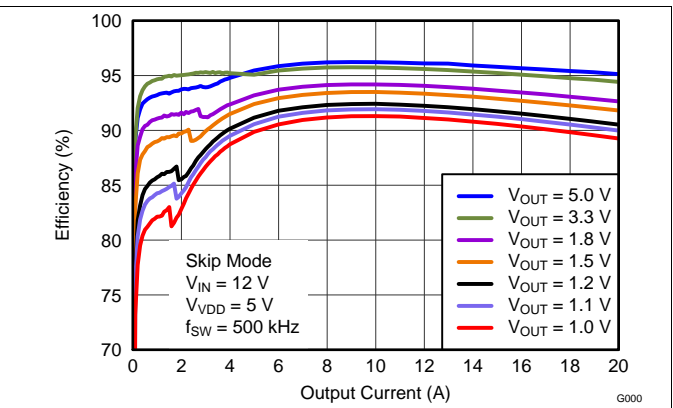

Figure 31. Efficiency vs Output Current

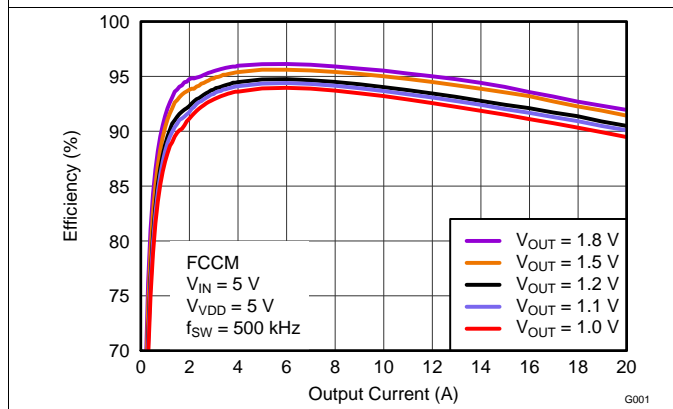

Figure 32. Efficiency vs Output Current

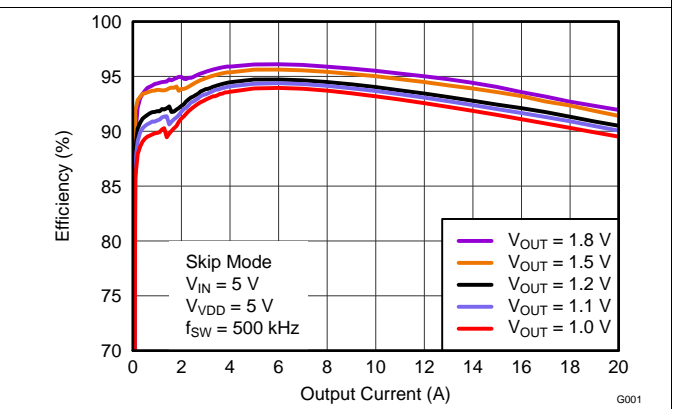

Figure 33. Efficiency vs Output Current

7 Detailed Description

7.1 Overview

The TPS53353 is a high-efficiency, single channel, synchronous buck converter suitable for low output voltage point-of-load applications in computing and similar digital consumer applications. The device features proprietary D-CAP™ mode control combined with an adaptive on-time architecture. This combination is ideal for building modern low duty ratio, ultra-fast load step response DC-DC converters. The output voltage ranges from 0.6 V to 5.5 V. The conversion input voltage range is from 1.5 V up to 15 V and the VDD bias voltage is from 4.5 V to 25 V. The D-CAP™ mode uses the equivalent series resistance (ESR) of the output capacitor(s) to sense the device current. One advantage of this control scheme is that it does not require an external phase compensation network. This allows a simple design with a low external component count. Eight preset switching frequency values can be chosen using a resistor connected from the RF pin to ground or VREG. Adaptive on-time control tracks the preset switching frequency over a wide input and output voltage range while allowing the switching frequency to increase at the step-up of the load.

The TPS53353 has a MODE pin to select between auto-skip mode and forced continuous conduction mode (FCCM) for light load conditions. The MODE pin also sets the selectable soft-start time ranging from 0.7 ms to 5.6 ms as shown in Table 3.

7.2 Functional Block Diagram

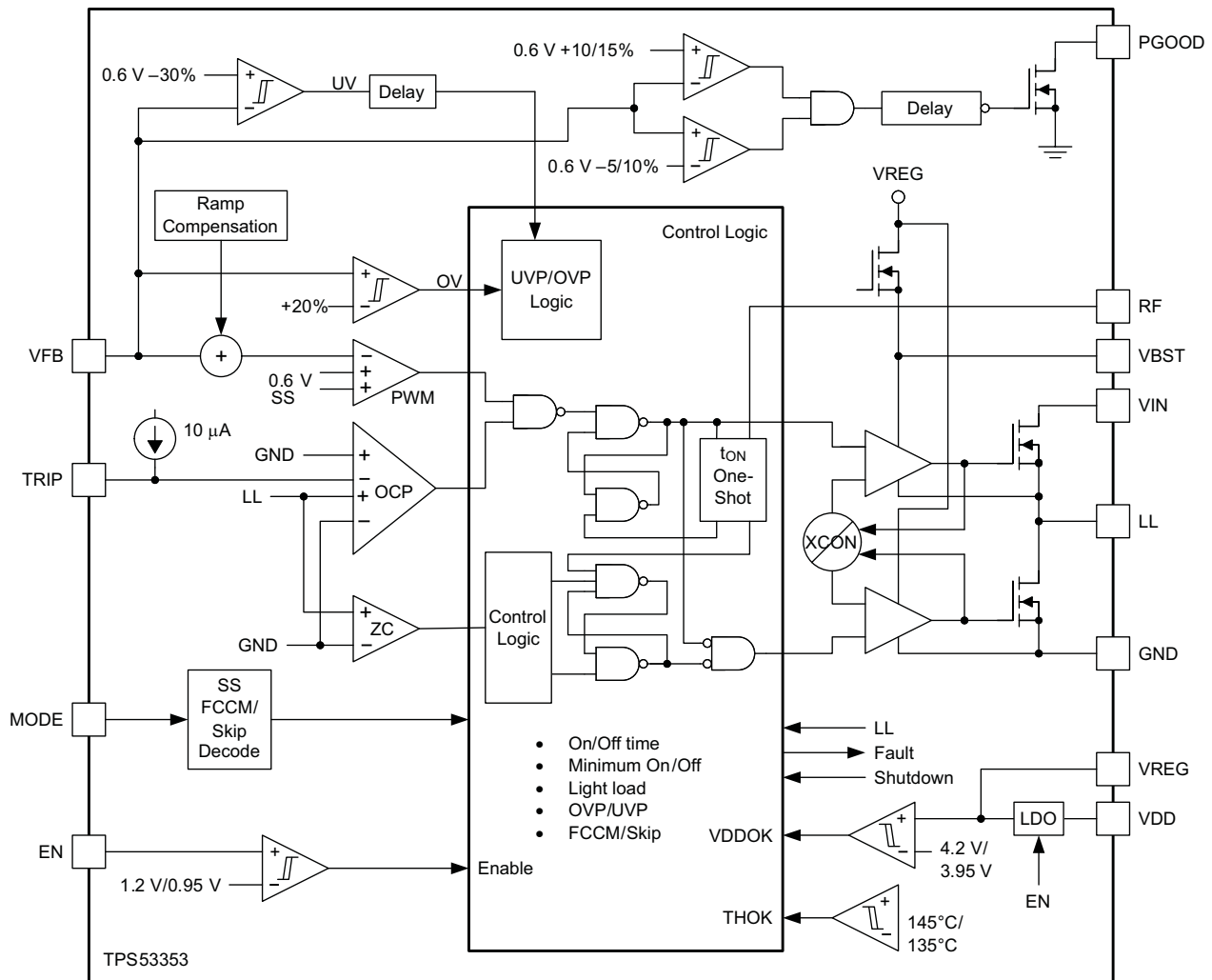

UDG-11048

Functional Block Diagram (continued)

NOTE

The thresholds in this block diagram are typical values. Refer to the [Electrical Characteristics](#) table for threshold limits.

7.3 Feature Description

7.3.1 5-V LDO and VREG Start-Up

TPS53353 provides an internal 5-V LDO function using input from VDD and output to VREG. When the VDD voltage rises above 2 V, the internal LDO is enabled and outputs voltage to the VREG pin. The VREG voltage provides the bias voltage for the internal analog circuitry and also provides the supply voltage for the gate drives.

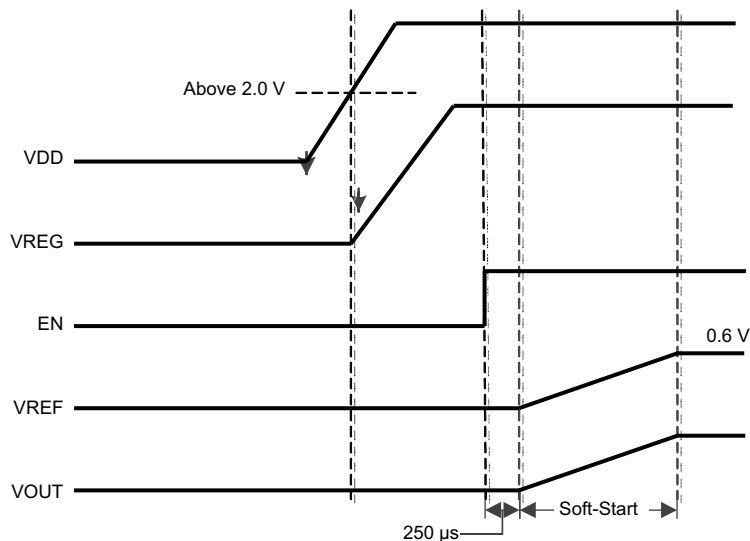

Figure 34. Power Up Sequence

NOTE

The 5-V LDO is not controlled by the EN pin. The LDO starts-up any time VDD rises to approximately 2 V. (See [Figure 34](#).)

7.3.2 Adaptive On-Time D-CAP™ Control and Frequency Selection

The TPS53353 does not have a dedicated oscillator to determine switching frequency. However, the device operates with pseudo-constant frequency by feed-forwarding the input and output voltages into the on-time one-shot timer. The adaptive on-time control adjusts the on-time to be inversely proportional to the input voltage and proportional to the output voltage ($t_{ON} \propto V_{OUT}/V_{IN}$).

This makes the switching frequency fairly constant in steady state conditions over a wide input voltage range. The switching frequency is selectable from eight preset values by a resistor connected between the RF pin and GND or between the RF pin and the VREG pin as shown in [Table 1](#). (Maintaining open resistance sets the switching frequency to 500 kHz.)

Table 1. Resistor and Switching Frequency

RESISTOR (R _{RF}) CONNECTIONS		SWITCHING FREQUENCY (f _{sw}) (kHz)
VALUE (kΩ)	CONNECT TO	
0	GND	250
187	GND	300

Table 1. Resistor and Switching Frequency (continued)

RESISTOR (R_{RF}) CONNECTIONS		SWITCHING FREQUENCY (f_{sw}) (kHz)
VALUE (k Ω)	CONNECT TO	
619	GND	400
OPEN	n/a	500
866	VREG	650
309	VREG	750
124	VREG	850
0	VREG	970

The off-time is modulated by a PWM comparator. The VFB node voltage (the mid-point of resistor divider) is compared to the internal 0.6-V reference voltage added with a ramp signal. When both signals match, the PWM comparator asserts a set signal to terminate the off time (turn off the low-side MOSFET and turn on high-side MOSFET). The set signal is valid if the inductor current level is below the OCP threshold, otherwise the off time is extended until the current level falls below the threshold.

Figure 35 and Figure 36 show two on-time control schemes.

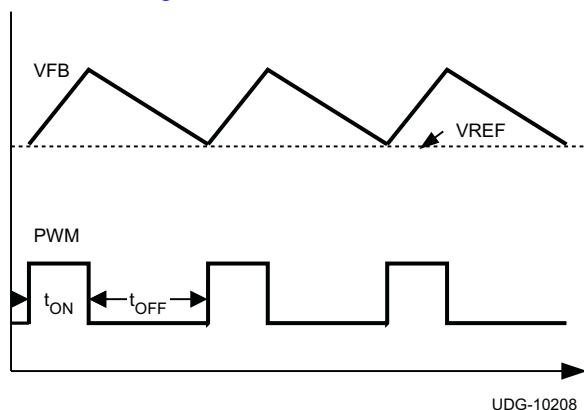

Figure 35. On-Time Control Without Ramp Compensation

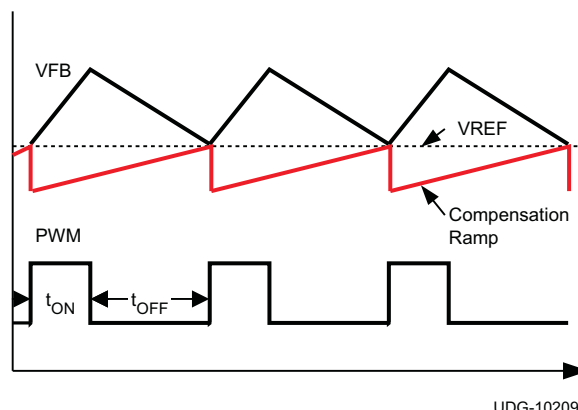

Figure 36. On-Time Control With Ramp Compensation

7.3.3 Ramp Signal

The TPS53353 adds a ramp signal to the 0.6-V reference in order to improve jitter performance. As described in the previous section, the feedback voltage is compared with the reference information to keep the output voltage in regulation. By adding a small ramp signal to the reference, the signal-to-noise ratio at the onset of a new switching cycle is improved. Therefore the operation becomes less jittery and more stable. The ramp signal is controlled to start with -7 mV at the beginning of an on-cycle and becomes 0 mV at the end of an off-cycle in steady state.

During skip mode operation, under discontinuous conduction mode (DCM), the switching frequency is lower than the nominal frequency and the off-time is longer than the off-time in CCM. Because of the longer off-time, the ramp signal extends after crossing 0 mV. However, it is clamped at 3 mV to minimize the DC offset.

7.3.4 Adaptive Zero Crossing

The TPS53353 has an adaptive zero crossing circuit which performs optimization of the zero inductor current detection at skip mode operation. This function pursues ideal low-side MOSFET turning off timing and compensates inherent offset voltage of the Z-C comparator and delay time of the Z-C detection circuit. It prevents SW-node swing-up caused by too late detection and minimizes diode conduction period caused by too early detection. As a result, better light load efficiency is delivered.

7.3.5 Power-Good

The TPS53353 has power-good output that indicates high when switcher output is within the target. The power-good function is activated after soft-start has finished. If the output voltage becomes within +10% and –5% of the target value, internal comparators detect power-good state and the power-good signal becomes high after a 1- μ s internal delay. If the output voltage goes outside of +15% or –10% of the target value, the power-good signal becomes low after two microsecond (2- μ s) internal delay. The power-good output is an open drain output and must be pulled up externally.

The power-good MOSFET is powered through the VDD pin. V_{VDD} must be >1 V in order to have a valid power-good logic. It is recommended to pull PGOOD up to VREG (or a voltage divided from VREG) so that the power-good logic is still valid even without VDD supply.

7.3.6 Current Sense, Overcurrent and Short Circuit Protection

TPS53353 has cycle-by-cycle overcurrent limiting control. The inductor current is monitored during the *OFF* state and the controller maintains the *OFF* state during the period in that the inductor current is larger than the overcurrent trip level. In order to provide both good accuracy and cost effective solution, TPS53353 supports temperature compensated MOSFET $R_{DS(on)}$ sensing. The TRIP pin should be connected to GND through the trip voltage setting resistor, R_{TRIP} . The TRIP terminal sources current (I_{TRIP}) which is 10 μ A typically at room temperature, and the trip level is set to the OCL trip voltage V_{TRIP} as shown in Equation 1.

$$V_{TRIP} \text{ (mV)} = R_{TRIP} \text{ (k}\Omega\text{)} \times I_{TRIP} \text{ (}\mu\text{A)} \quad (1)$$

The inductor current is monitored by the LL pin. The GND pin is used as the positive current sensing node and the LL pin is used as the negative current sense node. The trip current, I_{TRIP} has 4700ppm/°C temperature slope to compensate the temperature dependency of the $R_{DS(on)}$.

As the comparison is made during the *OFF* state, V_{TRIP} sets the valley level of the inductor current. Thus, the load current at the overcurrent threshold, I_{OCP} , can be calculated as shown in Equation 2.

$$I_{OCP} = \frac{V_{TRIP}}{(32 \times R_{DS(on)})} + \frac{I_{IND(ripple)}}{2} = \frac{V_{TRIP}}{(32 \times R_{DS(on)})} + \frac{1}{2 \times L \times f_{SW}} \times \frac{(V_{IN} - V_{OUT}) \times V_{OUT}}{V_{IN}} \quad (2)$$

In an overcurrent or short circuit condition, the current to the load exceeds the current to the output capacitor thus the output voltage tends to decrease. Eventually, it crosses the undervoltage protection threshold and shuts down. After a hiccup delay (16 ms with 0.7 ms sort-start), the controller restarts. If the overcurrent condition remains, the procedure is repeated and the device enters hiccup mode.

Hiccup time calculation:

$$t_{HIC(wait)} = (2^n + 257) \times 4 \mu\text{s}$$

where

- N = 8, 9, 10, or 11 depending on soft start time selection (3)

$$t_{HIC(dly)} = 7 \times (2^n + 257) \times 4 \mu\text{s} \quad (4)$$

Table 2. Hiccup Time Calculation

SELECTED SOFT-START TIME (t_{SS}) (ms)	n	HICCUP WAIT TIME ($t_{HIC(wait)}$) (ms)	HICCUP DELAY TIME ($t_{HIC(dly)}$) (ms)
0.7	8	2.052	14.364
1.4	9	3.076	21.532
2.8	10	5.124	35.868
5.6	11	9.22	64.54

7.3.7 Overvoltage and Undervoltage Protection

TPS53353 monitors a resistor divided feedback voltage to detect over and under voltage. When the feedback voltage becomes lower than 70% of the target voltage, the UVP comparator output goes high and an internal UVP delay counter begins counting. After 1ms, TPS53353 latches OFF both high-side and low-side MOSFETs drivers. The controller restarts after a hiccup delay (16 ms with 0.7 ms soft-start). This function is enabled 1.5-ms after the soft-start is completed.

When the feedback voltage becomes higher than 120% of the target voltage, the OVP comparator output goes high and the circuit latches OFF the high-side MOSFET driver and latches ON the low-side MOSFET driver. The output voltage decreases. If the output voltage reaches UV threshold, then both high-side MOSFET and low-side MOSFET driver will be OFF and the device restarts after a hiccup delay. If the OV condition remains, both high-side MOSFET and low-side MOSFET driver remains OFF until the OV condition is removed.

7.3.8 UVLO Protection

The TPS53353 uses VREG undervoltage lockout protection (UVLO). When the VREG voltage is lower than 3.95 V, the device shuts off. When the VREG voltage is higher than 4.2V, the device restarts. This is a non-latch protection.

7.3.9 Thermal Shutdown

TPS53353 monitors the temperature of itself. If the temperature exceeds the threshold value (typically 145°C), TPS53353 is shut off. When the temperature falls about 10°C below the threshold value, the device will turn back on. This is a non-latch protection.

7.4 Device Functional Modes

7.4.1 Small Signal Model

From small-signal loop analysis, a buck converter using D-CAP™ mode can be simplified as shown in Figure 37.

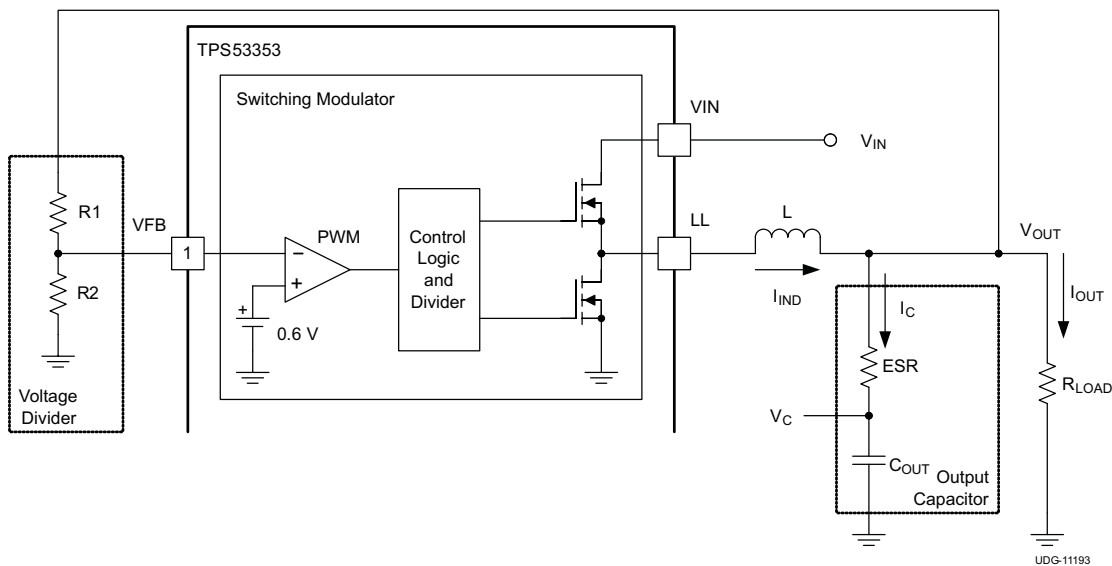

Figure 37. Simplified Modulator Model

The output voltage is compared with the internal reference voltage (ramp signal is ignored here for simplicity). The PWM comparator determines the timing to turn on the high-side MOSFET. The gain and speed of the comparator can be assumed high enough to keep the voltage at the beginning of each on cycle substantially constant.

$$H(s) = \frac{1}{s \times ESR \times C_{OUT}} \quad (5)$$

For loop stability, the 0-dB frequency, f_0 , defined in Equation 6 needs to be lower than 1/4 of the switching frequency.

$$f_0 = \frac{1}{2\pi \times ESR \times C_{OUT}} \leq \frac{f_{SW}}{4} \quad (6)$$

Device Functional Modes (continued)

According to [Equation 6](#), the loop stability of D-CAP™ mode modulator is mainly determined by the capacitor's chemistry. For example, specialty polymer capacitors (SP-CAP) have an output capacitance in the order of several 100 μF and ESR in range of 10 $\text{m}\Omega$. These makes f_0 on the order of 100 kHz or less, creating a stable loop. However, ceramic capacitors have an f_0 at more than 700 kHz, and need special care when used with this modulator. An application circuit for ceramic capacitor is described in the [External Component Selection Using All Ceramic Output Capacitors](#) section.

7.4.2 Enable, Soft Start, and Mode Selection

When the EN pin voltage rises above the enable threshold voltage (typically 1.2 V), the controller enters its start-up sequence. The internal LDO regulator starts immediately and regulates to 5 V at the VREG pin. The controller then uses the first 250 μs to calibrate the switching frequency setting resistance attached to the RF pin and stores the switching frequency code in internal registers. During this period, the MODE pin also senses the resistance attached to this pin and determines the soft-start time. Switching is inhibited during this phase. In the second phase, an internal DAC starts ramping up the reference voltage from 0 V to 0.6 V. Depending on the MODE pin setting, the ramping up time varies from 0.7 ms to 5.6 ms. Smooth and constant ramp-up of the output voltage is maintained during start-up regardless of load current.

Table 3. Soft-Start and MODE Settings

MODE SELECTION	ACTION	SOFT-START TIME (ms)	R _{MODE} (k Ω)
Auto-skip	Pulldown to GND	0.7	39
		1.4	100
		2.8	200
		5.6	475
Forced CCM ⁽¹⁾	Connect to PGOOD	0.7	39
		1.4	100
		2.8	200
		5.6	475

(1) Device enters FCCM after the PGOOD pin goes high when MODE is connected to PGOOD through the resistor R_{MODE}.

After soft-start begins, the MODE pin becomes the input of an internal comparator which determines auto-skip or FCCM mode operation. If MODE voltage is higher than 1.3 V, the converter enters into FCCM mode. Otherwise it will be in auto-skip mode at light load condition. Typically, when FCCM mode is selected, the MODE pin is connected to PGOOD through the R_{MODE} resistor, so that before PGOOD goes high the converter remains in auto-skip mode.

7.4.3 Auto-Skip Eco-mode™ Light Load Operation

While the MODE pin is pulled low via R_{MODE}, TPS53353 automatically reduces the switching frequency at light load conditions to maintain high efficiency. Detailed operation is described as follows. As the output current decreases from heavy load condition, the inductor current is also reduced and eventually comes to the point that its rippled valley touches zero level, which is the boundary between continuous conduction and discontinuous conduction modes. The synchronous MOSFET is turned off when this zero inductor current is detected. As the load current further decreases, the converter runs into discontinuous conduction mode (DCM). The on-time is kept almost the same as it was in the continuous conduction mode so that it takes longer to discharge the output capacitor with smaller load current to the level of the reference voltage. The transition point to the light-load operation I_{OUT(LL)} (that is, the threshold between continuous and discontinuous conduction mode) can be calculated as shown in [Equation 7](#).

$$I_{\text{OUT(LL)}} = \frac{1}{2 \times L \times f_{\text{SW}}} \times \frac{(V_{\text{IN}} - V_{\text{OUT}}) \times V_{\text{OUT}}}{V_{\text{IN}}}$$

where

- f_{SW} is the PWM switching frequency

(7)

Switching frequency versus output current in the light load condition is a function of L , V_{IN} , and V_{OUT} , but it decreases almost proportionally to the output current from the $I_{OUT(LL)}$ given in [Equation 7](#). For example, it is 60 kHz at $I_{OUT(LL)}/5$ if the frequency setting is 300 kHz.

7.4.4 Forced Continuous Conduction Mode

When the MODE pin is tied to PGOOD through a resistor, the controller keeps continuous conduction mode (CCM) in light load condition. In this mode, switching frequency is kept almost constant over the entire load range which is suitable for applications need tight control of the switching frequency at a cost of lower efficiency.

8 Application and Implementation

NOTE

Information in the following applications sections is not part of the TI component specification, and TI does not warrant its accuracy or completeness. TI's customers are responsible for determining suitability of components for their purposes. Customers should validate and test their design implementation to confirm system functionality.

8.1 Application Information

The TPS53353 is a high-efficiency, single channel, synchronous buck converter suitable for low output voltage point-of-load applications in computing and similar digital consumer applications. The device features proprietary D-CAP mode control combined with an adaptive on-time architecture. This combination is ideal for building modern low duty ratio, ultra-fast load step response DC-DC converters. The output voltage ranges from 0.6 V to 5.5 V. The conversion input voltage range is from 1.5 V up to 15 V and the VDD bias voltage is from 4.5 V to 25 V. The D-CAP mode uses the equivalent series resistance (ESR) of the output capacitor(s) to sense the device current. One advantage of this control scheme is that it does not require an external phase compensation network. This allows a simple design with a low external component count. Eight preset switching frequency values can be chosen using a resistor connected from the RF pin to ground or VREG. Adaptive on-time control tracks the preset switching frequency over a wide input and output voltage range while allowing the switching frequency to increase at the step-up of the load.

8.2 Typical Applications

8.2.1 Typical Application Circuit Diagram

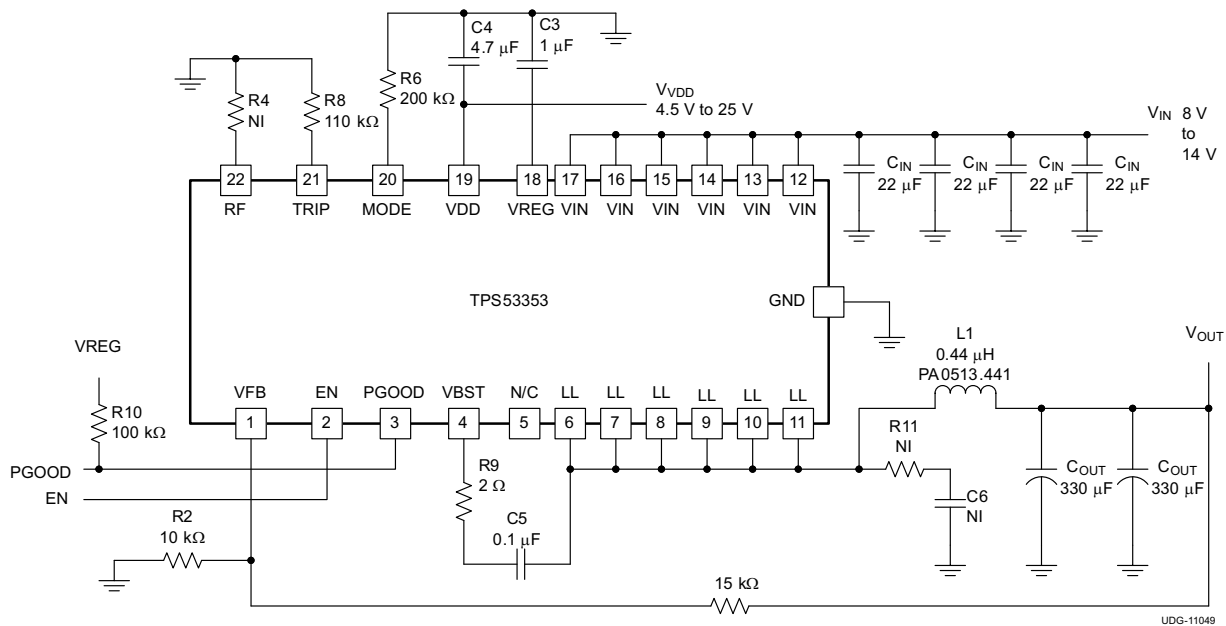

Figure 38. Typical Application Circuit Diagram

Typical Applications (continued)

8.2.1.1 Design Requirements

Table 4. Design Parameters

PARAMETER		TEST CONDITIONS	MIN	TYP	MAX	UNIT
INPUT CHARACTERISTICS						
V _{IN}	Voltage range		8	12	14	V
I _{MAX}	Maximum Input current	V _{IN} = 8 V, I _{OUT} = 20 A		4.1		A
	No load input current	V _{IN} = 14 V, I _{OUT} = 0 A with auto-skip mode		1		mA
OUTPUT CHARACTERISTICS						
V _{OUT}	Output voltage			1.5		V
	Output voltage regulation	Line regulation, 8 V ≤ V _{IN} ≤ 15 V		0.1%		
		Load regulation, V _{IN} = 12 V, 0 A ≤ I _{OUT} ≤ 20 A with FCCM			0.2%	
V _{RIPPLE}	Output voltage ripple	V _{IN} = 12 V, I _{OUT} = 20 A with FCCM		20		mV _{PP}
I _{LOAD}	Output load current		0		20	A
I _{OC}	Output overcurrent threshold			26		A
t _{SS}	Soft-start time			1.4		ms
SYSTEMS CHARACTERISTICS						
f _{SW}	Switching frequency			500		kHz
η	Peak efficiency	V _{IN} = 12 V, V _{OUT} = 1.1 V, I _{OUT} = 10 A		91.87%		
	Full load efficiency	V _{IN} = 12 V, V _{OUT} = 1.1 V, I _{OUT} = 20 A		91.38%		
T _A	Operating temperature			25		°C

8.2.1.2 Detailed Design Procedure

8.2.1.2.1 External Component Selection

Refer to the [External Component Selection Using All Ceramic Output Capacitors](#) section for guidelines for this design with all ceramic output capacitors.

The external components selection is a simple process when using organic semiconductors or special polymer output capacitors.

1. SELECT OPERATION MODE AND SOFT-START TIME

Select operation mode and soft-start time using [Table 3](#).

2. SELECT SWITCHING FREQUENCY

Select the switching frequency from 250 kHz to 1 MHz using [Table 1](#).

3. CHOOSE THE INDUCTOR

The inductance value should be determined to give the ripple current of approximately 1/4 to 1/2 of maximum output current. Larger ripple current increases output ripple voltage and improves signal-to-noise ratio and helps ensure stable operation, but increases inductor core loss. Using 1/3 ripple current to maximum output current ratio, the inductance can be determined by [Equation 8](#).

$$L = \frac{1}{I_{\text{IND(ripple)}} \times f_{\text{SW}}} \times \frac{(V_{\text{IN(max)}} - V_{\text{OUT}}) \times V_{\text{OUT}}}{V_{\text{IN(max)}}} = \frac{3}{I_{\text{OUT(max)}} \times f_{\text{SW}}} \times \frac{(V_{\text{IN(max)}} - V_{\text{OUT}}) \times V_{\text{OUT}}}{V_{\text{IN(max)}}} \quad (8)$$

The inductor requires a low DCR to achieve good efficiency. It also requires enough room above peak inductor current before saturation. The peak inductor current can be estimated in [Equation 9](#).

$$I_{\text{IND(peak)}} = \frac{V_{\text{TRIP}}}{32 \times R_{\text{DS(on)}}} + \frac{1}{L \times f_{\text{SW}}} \times \frac{(V_{\text{IN(max)}} - V_{\text{OUT}}) \times V_{\text{OUT}}}{V_{\text{IN(max)}}} \quad (9)$$

4. CHOOSE THE OUTPUT CAPACITORS

When organic semiconductor capacitors or specialty polymer capacitors are used, for loop stability, capacitance and ESR should satisfy Equation 6. For jitter performance, Equation 10 is a good starting point to determine ESR.

$$ESR = \frac{V_{OUT} \times 10\text{mV} \times (1-D)}{0.6\text{V} \times I_{IND(\text{ripple})}} = \frac{10\text{mV} \times L \times f_{SW}}{0.6\text{V}} = \frac{L \times f_{SW}}{60} (\Omega)$$

where

- D is the duty factor.
- The required output ripple slope is approximately 10 mV per t_{SW} (switching period) in terms of VFB terminal voltage. (10)

5. DETERMINE THE VALUE OF R1 AND R2

The output voltage is programmed by the voltage-divider resistor, R1 and R2 shown in Figure 37. R1 is connected between VFB pin and the output, and R2 is connected between the VFB pin and GND. Recommended R2 value is from 1 kΩ to 20 kΩ. Determine R1 using Equation 11.

$$R1 = \frac{V_{OUT} - \frac{I_{IND(\text{ripple})} \times ESR}{2} - 0.6}{0.6} \times R2 \tag{11}$$

6. CHOOSE THE OVERCURRENT SETTING RESISTOR

The overcurrent setting resistor, R_{TRIP} , can be determined by .

$$R_{TRIP}(\text{k}\Omega) = \frac{\left(I_{OCP} - \left(\frac{1}{2 \times L \times f_{SW}} \right) \times \frac{(V_{IN} - V_{OUT}) \times V_{OUT}}{V_{IN}} \right) \times 32 \times R_{DS(\text{on})}(\text{m}\Omega)}{I_{TRIP}(\mu\text{A})}$$

where

- I_{TRIP} is the TRIP pin sourcing current (10 μA).
- $R_{DS(\text{on})}$ is the thermally compensated on-time resistance value of the low-side MOSFET. (12)

Use an $R_{DS(\text{on})}$ value of 1.6 mΩ for an overcurrent level of approximately 20 A. Use an $R_{DS(\text{on})}$ value of 1.7 mΩ for overcurrent level of approximately 10 A.

8.2.1.3 Application Curves

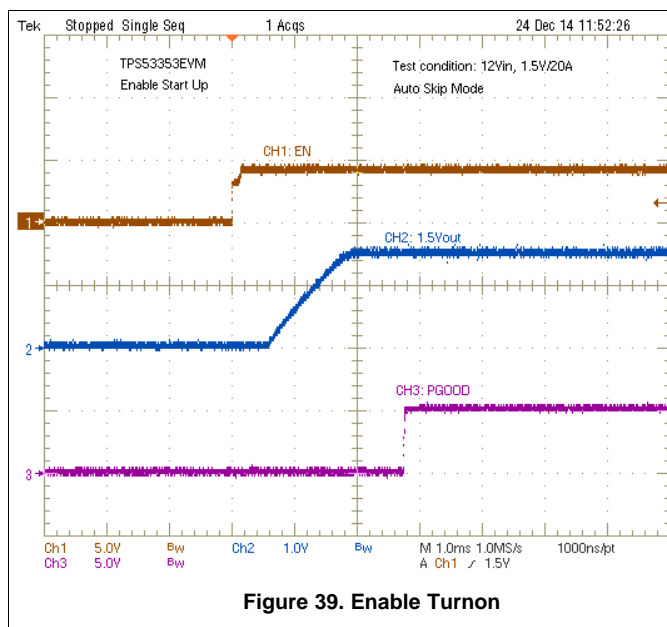

Figure 39. Enable Turnon

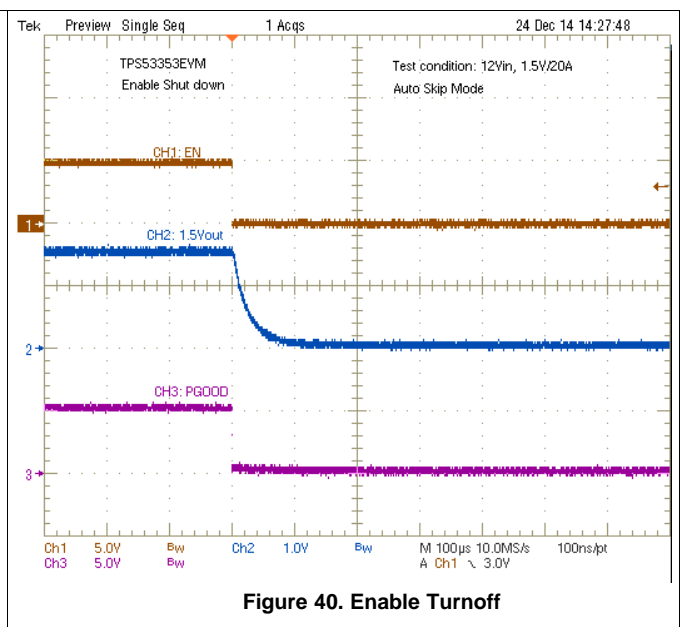

Figure 40. Enable Turnoff

8.2.2 Typical Application Circuit Diagram With Ceramic Output Capacitors

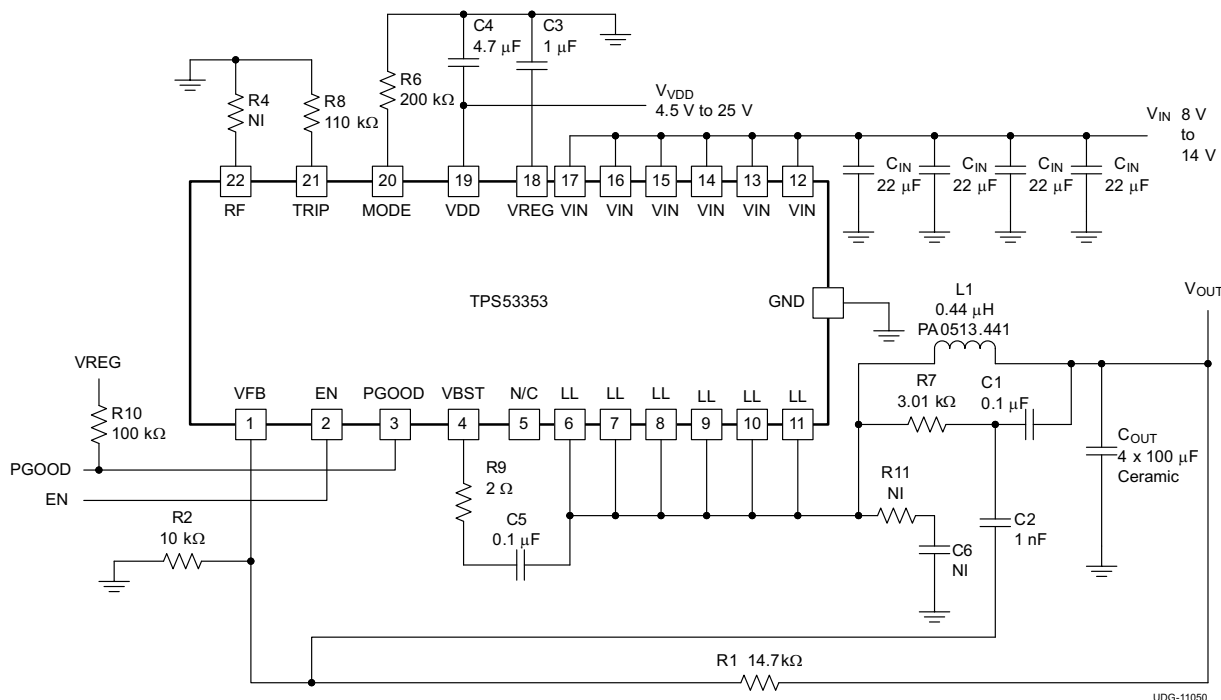

Figure 41. Typical Application Circuit Diagram With Ceramic Output Capacitors

8.2.2.1 Design Requirements

Table 5. Design Parameters

PARAMETER		TEST CONDITIONS	MIN	TYP	MAX	UNIT
INPUT CHARACTERISTICS						
V_{IN}	Voltage range		8	12	14	V
I_{MAX}	Maximum Input current	$V_{IN} = 8\text{ V}, I_{OUT} = 20\text{ A}$		4.1		A
	No load input current	$V_{IN} = 14\text{ V}, I_{OUT} = 0\text{ A}$ with auto-skip mode		1		mA
OUTPUT CHARACTERISTICS						
V_{OUT}	Output voltage			1.5		V
	Output voltage regulation	Line regulation, $8\text{ V} \leq V_{IN} \leq 15\text{ V}$ Load regulation, $V_{IN} = 12\text{ V}, 0\text{ A} \leq I_{OUT} \leq 20\text{ A}$ with FCCM		0.1%		
V_{RIPPLE}	Output voltage ripple	$V_{IN} = 12\text{ V}, I_{OUT} = 20\text{ A}$ with FCCM		20		mV _{PP}
I_{LOAD}	Output load current		0		20	A
I_{OCP}	Output overcurrent threshold			26		A
t_{SS}	Soft-start time			1.4		ms
SYSTEMS CHARACTERISTICS						
f_{SW}	Switching frequency			500		kHz
η	Peak efficiency	$V_{IN} = 12\text{ V}, V_{OUT} = 1.1\text{ V}, I_{OUT} = 10\text{ A}$		91.87%		
	Full load efficiency	$V_{IN} = 12\text{ V}, V_{OUT} = 1.1\text{ V}, I_{OUT} = 20\text{ A}$		91.38%		
T_A	Operating temperature			25		°C

8.2.2.2 Detailed Design Procedure

8.2.2.2.1 External Component Selection

Refer to the [External Component Selection Using All Ceramic Output Capacitors](#) section for guidelines for this design with all ceramic output capacitors.

The external components selection is a simple process when using organic semiconductors or special polymer output capacitors.

1. SELECT OPERATION MODE AND SOFT-START TIME

Select operation mode and soft-start time using [Table 3](#).

2. SELECT SWITCHING FREQUENCY

Select the switching frequency from 250 kHz to 1 MHz using [Table 1](#).

3. CHOOSE THE INDUCTOR

The inductance value should be determined to give the ripple current of approximately 1/4 to 1/2 of maximum output current. Larger ripple current increases output ripple voltage and improves signal-to-noise ratio and helps ensure stable operation, but increases inductor core loss. Using 1/3 ripple current to maximum output current ratio, the inductance can be determined by [Equation 8](#).

$$L = \frac{1}{I_{\text{IND(ripple)}} \times f_{\text{SW}}} \times \frac{(V_{\text{IN(max)}} - V_{\text{OUT}}) \times V_{\text{OUT}}}{V_{\text{IN(max)}}} = \frac{3}{I_{\text{OUT(max)}} \times f_{\text{SW}}} \times \frac{(V_{\text{IN(max)}} - V_{\text{OUT}}) \times V_{\text{OUT}}}{V_{\text{IN(max)}}} \quad (13)$$

The inductor requires a low DCR to achieve good efficiency. It also requires enough room above peak inductor current before saturation. The peak inductor current can be estimated in [Equation 9](#).

$$I_{\text{IND(peak)}} = \frac{V_{\text{TRIP}}}{32 \times R_{\text{DS(on)}}} + \frac{1}{L \times f_{\text{SW}}} \times \frac{(V_{\text{IN(max)}} - V_{\text{OUT}}) \times V_{\text{OUT}}}{V_{\text{IN(max)}}} \quad (14)$$

4. EXTERNAL COMPONENT SELECTION WITH ALL CERAMIC OUTPUT CAPACITORS

Refer to the [External Component Selection Using All Ceramic Output Capacitors](#) section to select external components because ceramic output capacitors are used in this design.

5. CHOOSE THE OVERCURRENT SETTING RESISTOR

The overcurrent setting resistor, R_{TRIP} , can be determined by .

$$R_{\text{TRIP}}(\text{k}\Omega) = \frac{\left(I_{\text{OCP}} - \left(\frac{1}{2 \times L \times f_{\text{SW}}} \right) \times \frac{(V_{\text{IN}} - V_{\text{OUT}}) \times V_{\text{OUT}}}{V_{\text{IN}}} \right) \times 32 \times R_{\text{DS(on)}}(\text{m}\Omega)}{I_{\text{TRIP}}(\mu\text{A})}$$

where

- I_{TRIP} is the TRIP pin sourcing current (10 μA).
- $R_{\text{DS(on)}}$ is the thermally compensated on-time resistance value of the low-side MOSFET. (15)

Use an $R_{\text{DS(on)}}$ value of 1.6 m Ω for an overcurrent level of approximately 20 A. Use an $R_{\text{DS(on)}}$ value of 1.7 m Ω for overcurrent level of approximately 10 A.

8.2.2.2.2 External Component Selection Using All Ceramic Output Capacitors

When a ceramic output capacitor is used, the stability criteria in [Equation 6](#) cannot be satisfied. The ripple injection approach as shown in [Figure 41](#) is implemented to increase the ripple on the VFB pin and make the system stable. In addition to the selections made using Steps 1 through Step 6 in the section, the ripple injection components must be selected. The C2 value can be fixed at 1 nF. The value of C1 can be selected from 10 nF to 200 nF.

$$\frac{L \times C_{OUT}}{R7 \times C1} > N \times \frac{t_{ON}}{2}$$

where

- N is the coefficient to account for L and C_{OUT} variation. (16)

N is also used to provide enough margin for stability. It is recommended N = 2 for V_{OUT} ≤ 1.8 V and N = 4 for V_{OUT} ≥ 3.3 V or when L ≤ 250 nH. The higher V_{OUT} needs a higher N value because the effective output capacitance is reduced significantly with higher DC bias. For example, a 6.3-V, 22-μF ceramic capacitor may have only 8 μF of effective capacitance when biased at 5 V.

Because the VFB pin voltage is regulated at the valley, the increased ripple on the VFB pin causes the increase of the VFB DC value. The AC ripple coupled to the VFB pin has two components, one coupled from SW node and the other coupled from the VOUT pin and they can be calculated using Equation 17 and Equation 18 when neglecting the output voltage ripple caused by equivalent series inductance (ESL).

$$V_{INJ_SW} = \frac{V_{IN} - V_{OUT}}{R7 \times C1} \times \frac{D}{f_{SW}} \tag{17}$$

$$V_{INJ_OUT} = ESR \times I_{IND(ripple)} + \frac{I_{IND(ripple)}}{8 \times C_{OUT} \times f_{SW}} \tag{18}$$

It is recommended that V_{INJ_SW} to be less than 50 mV. If the calculated V_{INJ_SW} is higher than 50 mV, then other parameters must be adjusted to reduce it. For example, C_{OUT} can be increased to satisfy Equation 16 with a higher R7 value, thereby reducing V_{INJ_SW}.

The DC voltage at the VFB pin can be calculated by Equation 19:

$$V_{VFB} = 0.6 + \frac{V_{INJ_SW} + V_{INJ_OUT}}{2} \tag{19}$$

And the resistor divider value can be determined by Equation 20:

$$R1 = \frac{V_{OUT} - V_{VFB}}{V_{VFB}} \times R2 \tag{20}$$

8.2.2.3 Application Curves

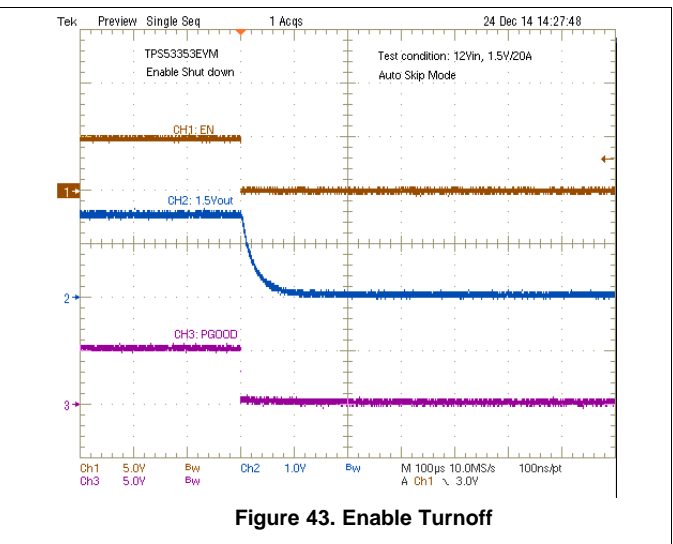
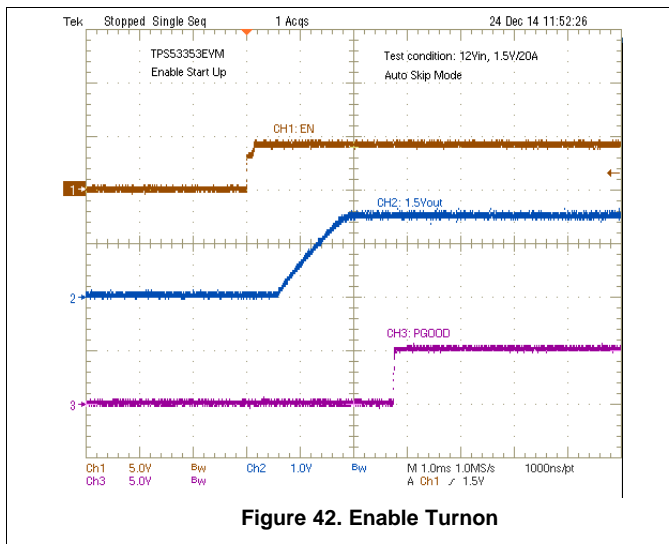

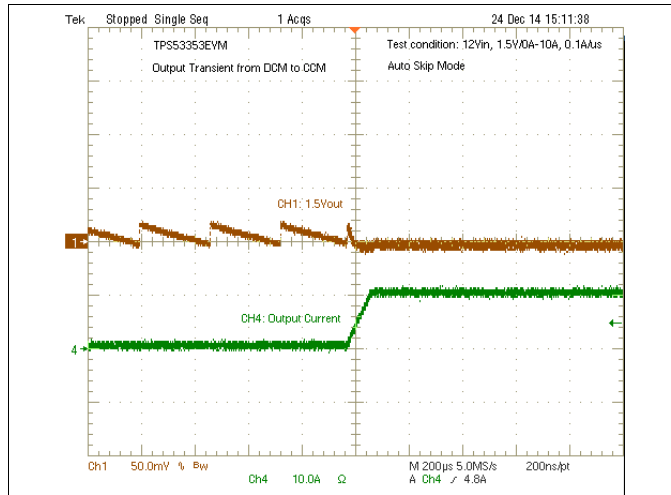

Figure 44. Output Transient from DCM to CCM

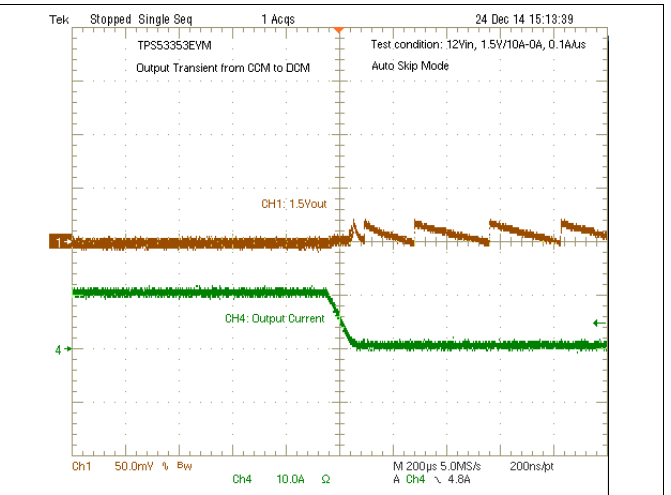

Figure 45. Output Transient from DCM to DCM

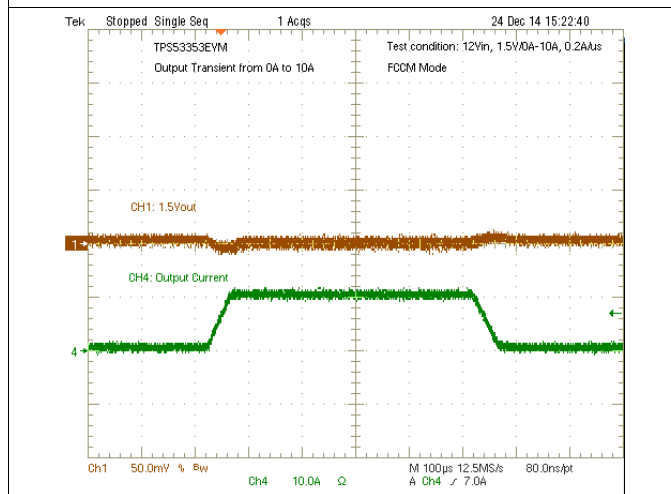

Figure 46. Output Transient with FCCM Mode

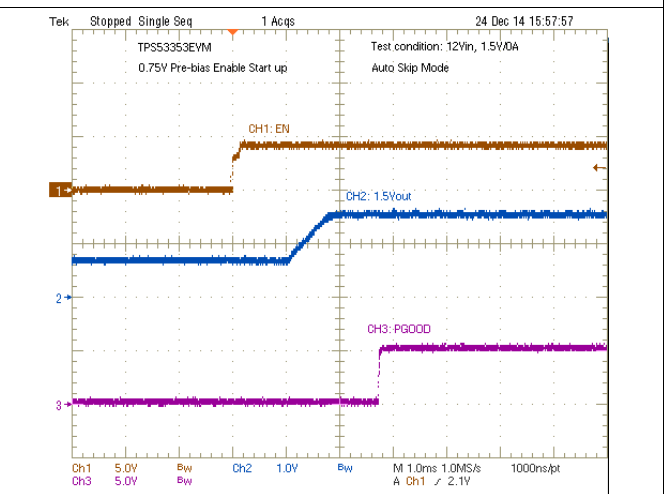

Figure 47. Output 0.75-V Prebias Turnon

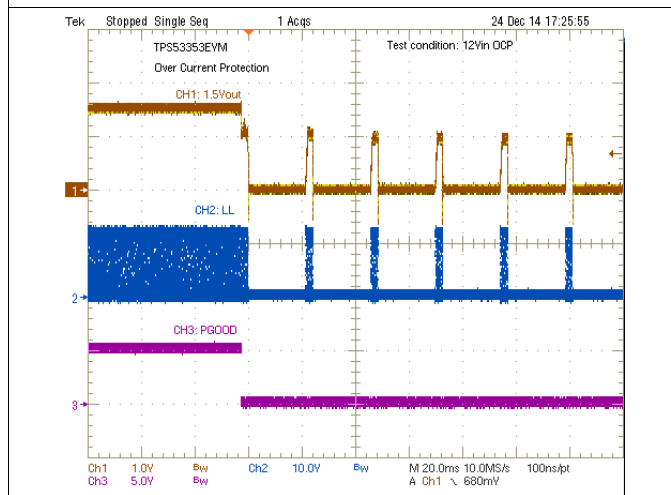

Figure 48. Output Overcurrent Protection

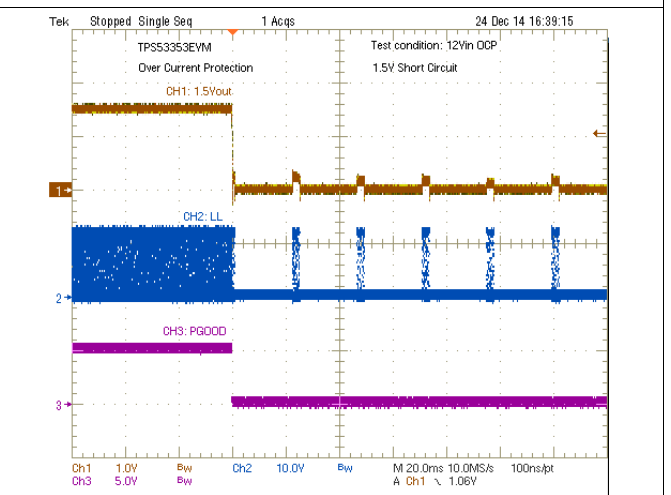

Figure 49. Output Short-Circuit Protection

9 Power Supply Recommendations

The device is designed to operate from an input voltage supply range from 1.5 V to 22 V (4.5 V to 25 V biased). This input supply must be well regulated. Proper bypassing of input supplies and internal regulators is also critical for noise performance, as is PCB layout and grounding scheme. See the recommendations in the [Layout](#) section.

10 Layout

10.1 Layout Guidelines

Certain points must be considered before starting a layout work using the TPS53353.

- The power components (including input/output capacitors, inductor and TPS53353) should be placed on one side of the PCB (solder side). At least one inner plane should be inserted, connected to ground, in order to shield and isolate the small signal traces from noisy power lines.
- All sensitive analog traces and components such as VFB, PGOOD, TRIP, MODE and RF should be placed away from high-voltage switching nodes such as LL, VBST to avoid coupling. Use internal layer(s) as ground plane(s) and shield feedback trace from power traces and components.
- Place the VIN decoupling capacitors as close to the VIN and PGND pins as possible to minimize the input AC current loop.
- Because the TPS53353 controls output voltage referring to voltage across VOUT capacitor, the top-side resistor of the voltage divider should be connected to the positive node of the VOUT capacitor. The GND of the bottom side resistor should be connected to the GND pad of the device. The trace from these resistors to the VFB pin should be short and thin.
- Place the frequency setting resistor (R_F), OCP setting resistor (R_{TRIP}) and mode setting resistor (R_{MODE}) as close to the device as possible. Use the common GND via to connect them to GND plane if applicable.
- Place the VDD and VREG decoupling capacitors as close to the device as possible. Ensure to provide GND vias for each decoupling capacitor and make the loop as small as possible.
- The PCB trace defined as switch node, which connects the LL pins and high-voltage side of the inductor, should be as short and wide as possible.
- Connect the ripple injection V_{OUT} signal (V_{OUT} side of the C1 capacitor in [Figure 41](#)) from the terminal of ceramic output capacitor. The AC coupling capacitor (C2 in [Figure 41](#)) should be placed near the device, and R7 and C1 can be placed near the power stage.
- Use separated vias or trace to connect LL node to snubber, boot strap capacitor and ripple injection resistor. Do not combine these connections.

10.2 Layout Example

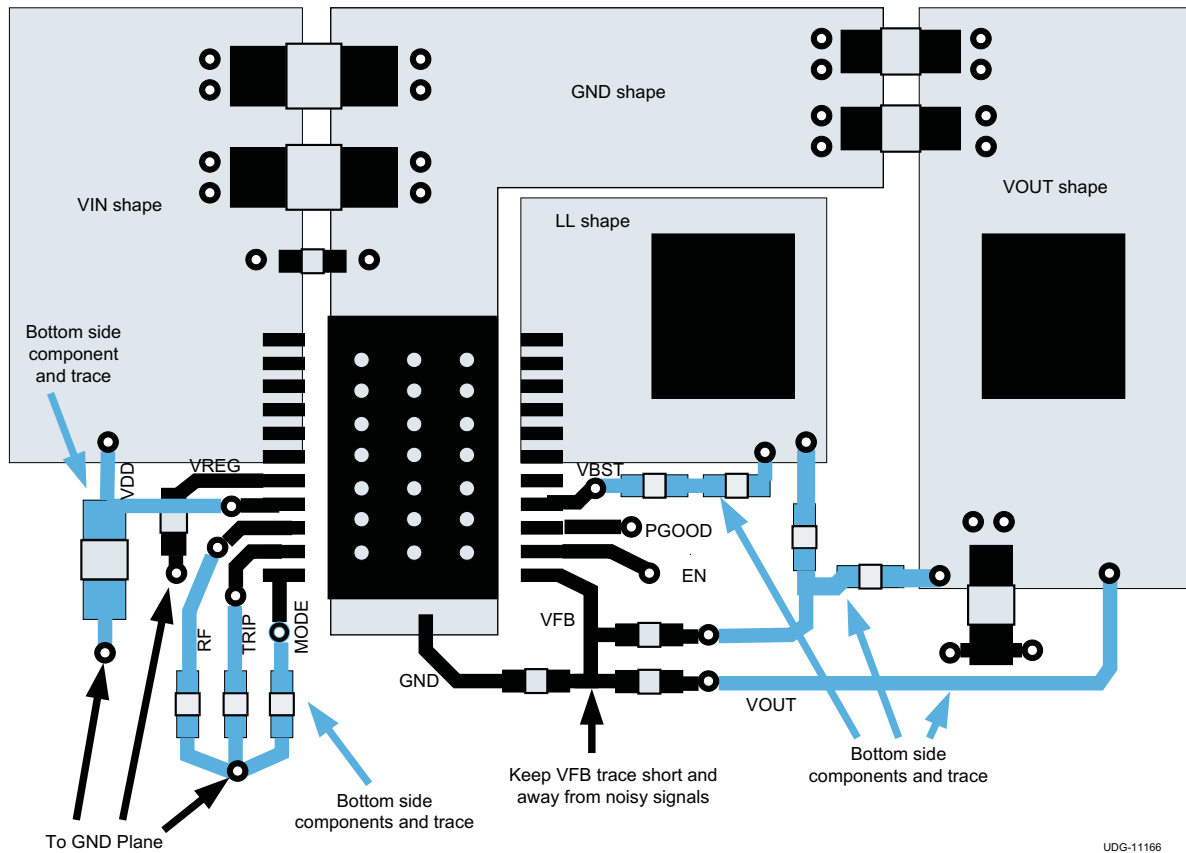

Figure 50. Layout Recommendation

UDG-11166

11 Device and Documentation Support

11.1 Trademarks

Eco-mode, NexFET, PowerPAD, SWIFT are trademarks of Texas Instruments. All other trademarks are the property of their respective owners.

11.2 Electrostatic Discharge Caution



These devices have limited built-in ESD protection. The leads should be shorted together or the device placed in conductive foam during storage or handling to prevent electrostatic damage to the MOS gates.

11.3 Glossary

[SLYZ022](#) — *TI Glossary*.

This glossary lists and explains terms, acronyms, and definitions.

12 Mechanical, Packaging, and Orderable Information

The following pages include mechanical, packaging, and orderable information. This information is the most current data available for the designated devices. This data is subject to change without notice and revision of this document. For browser-based versions of this data sheet, refer to the left-hand navigation.

PACKAGING INFORMATION

Orderable Device	Status (1)	Package Type	Package Drawing	Pins	Package Qty	Eco Plan (2)	Lead/Ball Finish (6)	MSL Peak Temp (3)	Op Temp (°C)	Device Marking (4/5)	Samples
TPS53353DQPR	ACTIVE	LSON-CLIP	DQP	22	2500	Pb-Free (RoHS Exempt)	NIPDAU SN	Level-2-260C-1 YEAR	-40 to 85	53353DQP	Samples
TPS53353DQPT	ACTIVE	LSON-CLIP	DQP	22	250	Pb-Free (RoHS Exempt)	NIPDAU SN	Level-2-260C-1 YEAR	-40 to 85	53353DQP	Samples

(1) The marketing status values are defined as follows:

ACTIVE: Product device recommended for new designs.

LIFEBUY: TI has announced that the device will be discontinued, and a lifetime-buy period is in effect.

NRND: Not recommended for new designs. Device is in production to support existing customers, but TI does not recommend using this part in a new design.

PREVIEW: Device has been announced but is not in production. Samples may or may not be available.

OBsolete: TI has discontinued the production of the device.

(2) **RoHS:** TI defines "RoHS" to mean semiconductor products that are compliant with the current EU RoHS requirements for all 10 RoHS substances, including the requirement that RoHS substance do not exceed 0.1% by weight in homogeneous materials. Where designed to be soldered at high temperatures, "RoHS" products are suitable for use in specified lead-free processes. TI may reference these types of products as "Pb-Free".

RoHS Exempt: TI defines "RoHS Exempt" to mean products that contain lead but are compliant with EU RoHS pursuant to a specific EU RoHS exemption.

Green: TI defines "Green" to mean the content of Chlorine (Cl) and Bromine (Br) based flame retardants meet JS709B low halogen requirements of <=1000ppm threshold. Antimony trioxide based flame retardants must also meet the <=1000ppm threshold requirement.

(3) MSL, Peak Temp. - The Moisture Sensitivity Level rating according to the JEDEC industry standard classifications, and peak solder temperature.

(4) There may be additional marking, which relates to the logo, the lot trace code information, or the environmental category on the device.

(5) Multiple Device Markings will be inside parentheses. Only one Device Marking contained in parentheses and separated by a "~" will appear on a device. If a line is indented then it is a continuation of the previous line and the two combined represent the entire Device Marking for that device.

(6) Lead/Ball Finish - Orderable Devices may have multiple material finish options. Finish options are separated by a vertical ruled line. Lead/Ball Finish values may wrap to two lines if the finish value exceeds the maximum column width.

Important Information and Disclaimer:The information provided on this page represents TI's knowledge and belief as of the date that it is provided. TI bases its knowledge and belief on information provided by third parties, and makes no representation or warranty as to the accuracy of such information. Efforts are underway to better integrate information from third parties. TI has taken and continues to take reasonable steps to provide representative and accurate information but may not have conducted destructive testing or chemical analysis on incoming materials and chemicals. TI and TI suppliers consider certain information to be proprietary, and thus CAS numbers and other limited information may not be available for release.

In no event shall TI's liability arising out of such information exceed the total purchase price of the TI part(s) at issue in this document sold by TI to Customer on an annual basis.

TAPE AND REEL INFORMATION



QUADRANT ASSIGNMENTS FOR PIN 1 ORIENTATION IN TAPE



*All dimensions are nominal

Device	Package Type	Package Drawing	Pins	SPQ	Reel Diameter (mm)	Reel Width W1 (mm)	A0 (mm)	B0 (mm)	K0 (mm)	P1 (mm)	W (mm)	Pin1 Quadrant
TPS53353DQPR	LSON-CLIP	DQP	22	2500	330.0	15.4	5.3	6.3	1.8	8.0	12.0	Q1
TPS53353DQPT	LSON-CLIP	DQP	22	250	330.0	15.4	5.3	6.3	1.8	8.0	12.0	Q1

TAPE AND REEL BOX DIMENSIONS

*All dimensions are nominal

Device	Package Type	Package Drawing	Pins	SPQ	Length (mm)	Width (mm)	Height (mm)
TPS53353DQPR	LSON-CLIP	DQP	22	2500	336.6	336.6	41.3
TPS53353DQPT	LSON-CLIP	DQP	22	250	336.6	336.6	41.3

DQP (R-PSON-N22)

PLASTIC SMALL OUTLINE NO-LEAD

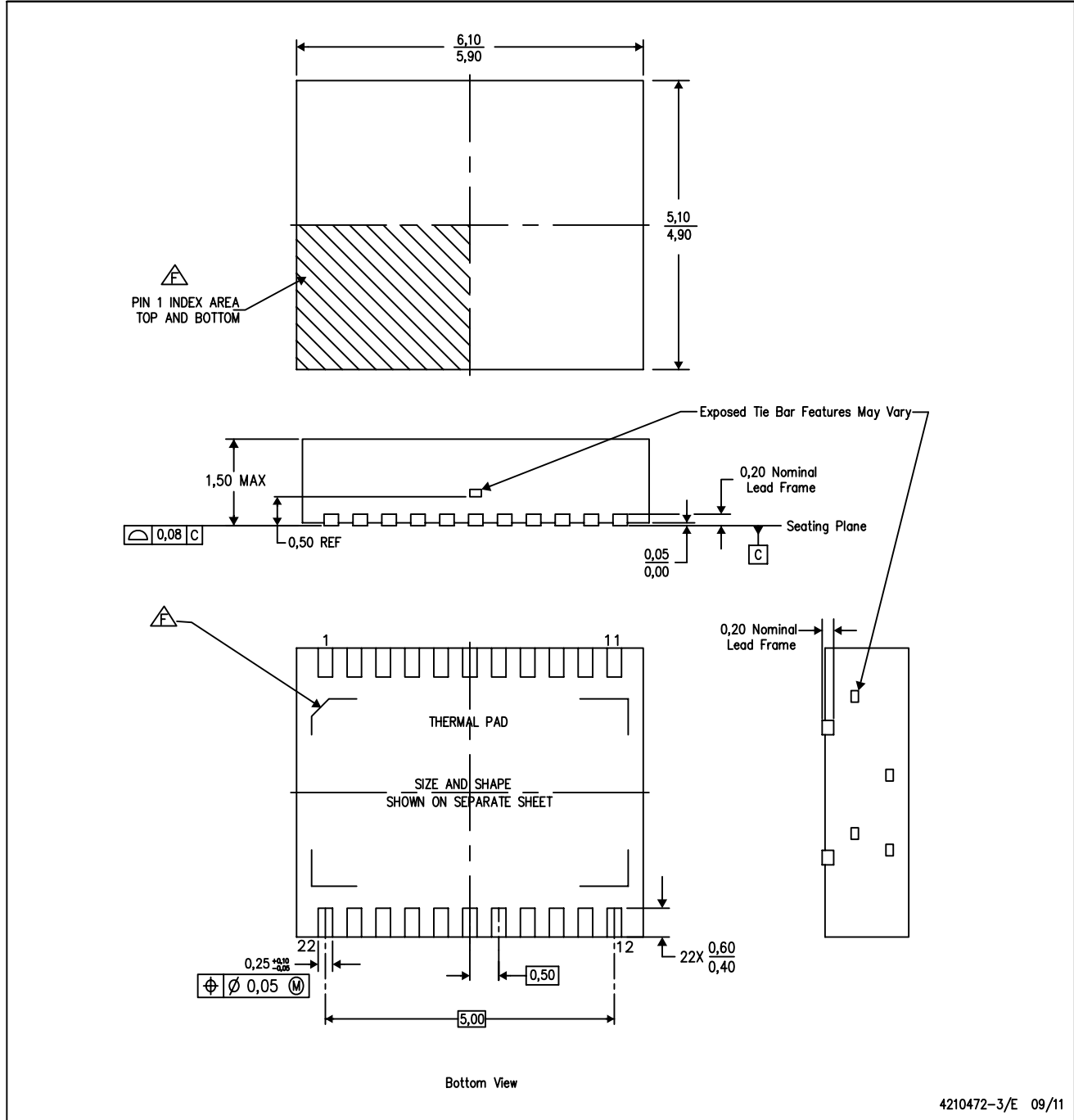

- NOTES:
- A. All linear dimensions are in millimeters. Dimensioning and tolerancing per ASME Y14.5M-1994.
 - B. This drawing is subject to change without notice.
 - C. Small Outline No-Lead (SON) package configuration.
 - D. The package thermal pad must be soldered to the board for thermal and mechanical performance.
 - E. See the additional figure in the Product Data Sheet for details regarding the exposed thermal pad features and dimensions.
 - F. Pin 1 identifiers are located on both top and bottom of the package and within the zone indicated. The Pin 1 identifiers are either a molded, marked, or metal feature.

THERMAL PAD MECHANICAL DATA

DQP (R-PSO-N22)

PLASTIC SMALL OUTLINE NO-LEAD

THERMAL INFORMATION

This package incorporates an exposed thermal pad that is designed to be attached directly to an external heatsink. The thermal pad must be soldered directly to the printed circuit board (PCB). After soldering, the PCB can be used as a heatsink. In addition, through the use of thermal vias, the thermal pad can be attached directly to the appropriate copper plane shown in the electrical schematic for the device, or alternatively, can be attached to a special heatsink structure designed into the PCB. This design optimizes the heat transfer from the integrated circuit (IC).

For information on the Quad Flatpack No-Lead (QFN) package and its advantages, refer to Application Report, QFN/SO-N PCB Attachment, Texas Instruments Literature No. SLUA271. This document is available at www.ti.com.

The exposed thermal pad dimensions for this package are shown in the following illustration.

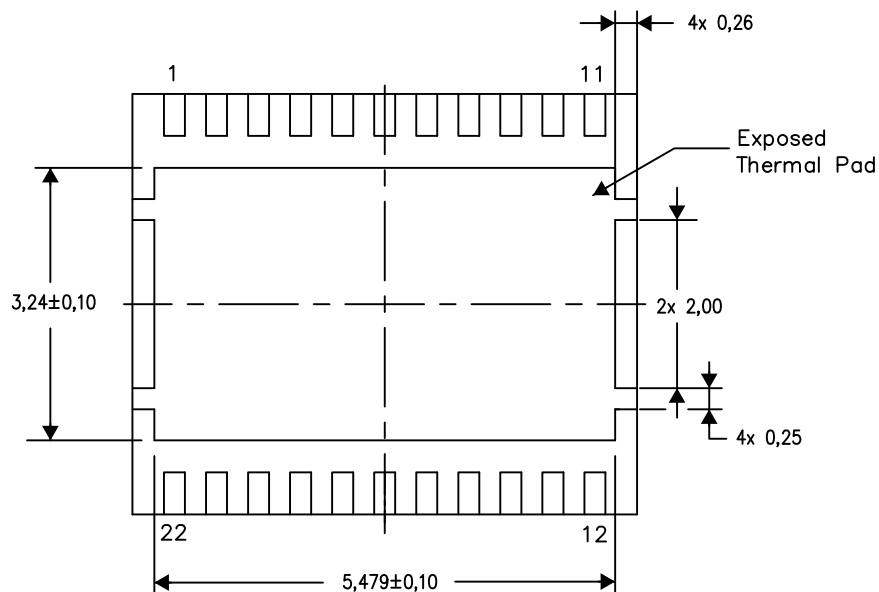

Bottom View

Exposed Thermal Pad Dimensions

4211024-3/H 08/15

NOTE: All linear dimensions are in millimeters

DQP (R-PSO-N22)

PLASTIC SMALL OUTLINE NO-LEAD

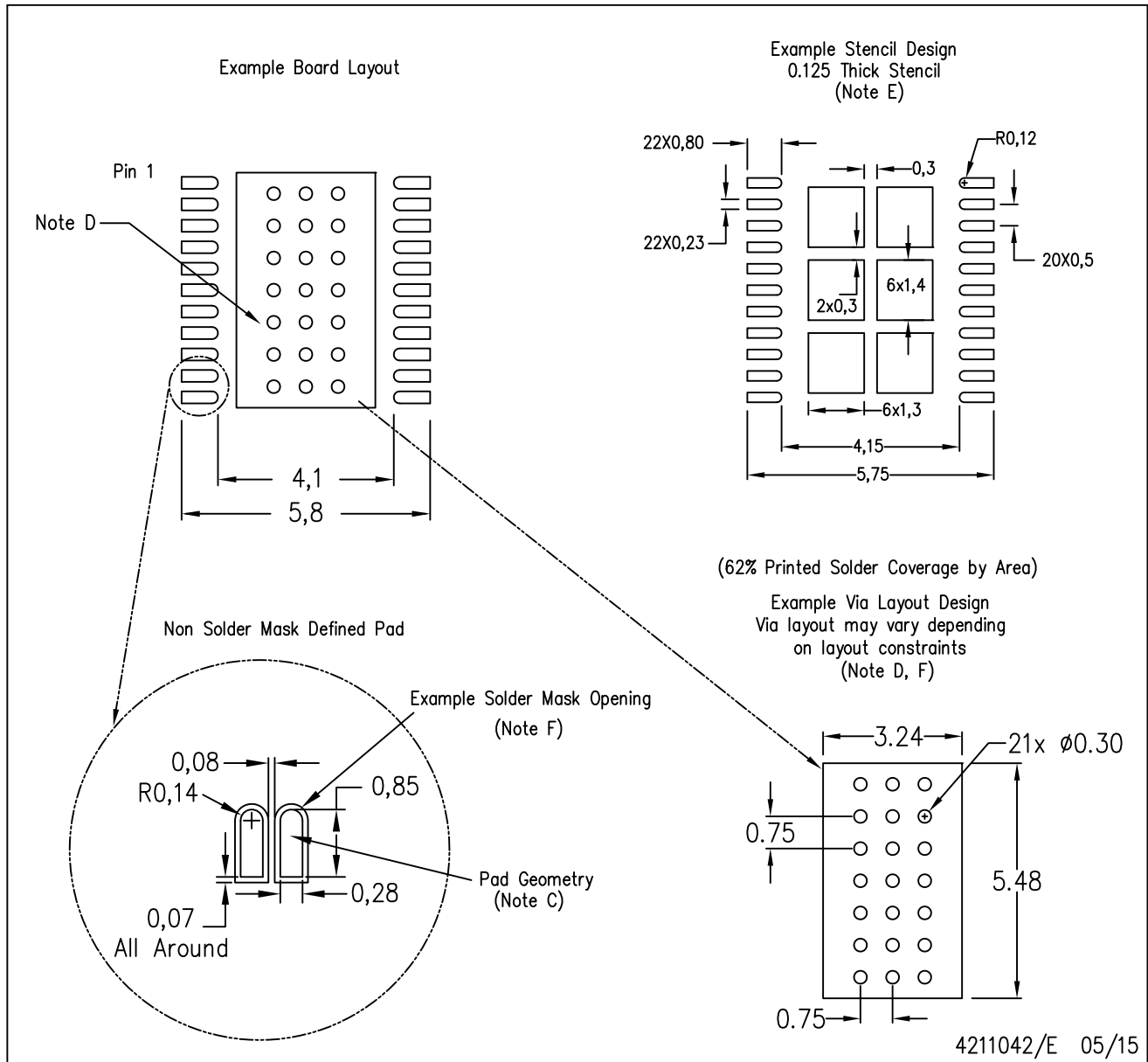

- NOTES:
- All linear dimensions are in millimeters.
 - This drawing is subject to change without notice.
 - Publication IPC-7351 is recommended for alternate designs.
 - This package is designed to be soldered to a thermal pad on the board. Refer to Application Note, QFN/SON PCB Attachment, Texas Instruments Literature No. SLUA271, and also the Product Data Sheets for specific thermal information, via requirements, and recommended board layout. These documents are available at www.ti.com <<http://www.ti.com>>.
 - Laser cutting apertures with trapezoidal walls and also rounding corners will offer better paste release. Customers should contact their board assembly site for stencil design recommendations. Refer to IPC 7525 for stencil design considerations.
 - Customers should contact their board fabrication site for recommended solder mask tolerances and via tenting recommendations for vias placed in the thermal pad.

IMPORTANT NOTICE AND DISCLAIMER

TI PROVIDES TECHNICAL AND RELIABILITY DATA (INCLUDING DATASHEETS), DESIGN RESOURCES (INCLUDING REFERENCE DESIGNS), APPLICATION OR OTHER DESIGN ADVICE, WEB TOOLS, SAFETY INFORMATION, AND OTHER RESOURCES "AS IS" AND WITH ALL FAULTS, AND DISCLAIMS ALL WARRANTIES, EXPRESS AND IMPLIED, INCLUDING WITHOUT LIMITATION ANY IMPLIED WARRANTIES OF MERCHANTABILITY, FITNESS FOR A PARTICULAR PURPOSE OR NON-INFRINGEMENT OF THIRD PARTY INTELLECTUAL PROPERTY RIGHTS.

These resources are intended for skilled developers designing with TI products. You are solely responsible for (1) selecting the appropriate TI products for your application, (2) designing, validating and testing your application, and (3) ensuring your application meets applicable standards, and any other safety, security, or other requirements. These resources are subject to change without notice. TI grants you permission to use these resources only for development of an application that uses the TI products described in the resource. Other reproduction and display of these resources is prohibited. No license is granted to any other TI intellectual property right or to any third party intellectual property right. TI disclaims responsibility for, and you will fully indemnify TI and its representatives against, any claims, damages, costs, losses, and liabilities arising out of your use of these resources.

TI's products are provided subject to TI's Terms of Sale (www.ti.com/legal/termsofsale.html) or other applicable terms available either on ti.com or provided in conjunction with such TI products. TI's provision of these resources does not expand or otherwise alter TI's applicable warranties or warranty disclaimers for TI products.

Mailing Address: Texas Instruments, Post Office Box 655303, Dallas, Texas 75265
Copyright © 2020, Texas Instruments Incorporated