

Recommendations for Screw Tightening Torque for IGBT Discrete Devices

Charles Low Khai Yen, IFMY DC PMM DPC
Dr. Christian Kasztelan, IFAG IPC TD ICD

Edition 2011-02-02
Published by
Infineon Technologies Austria AG
9500 Villach, Austria
© Infineon Technologies Austria AG 2011.
All Rights Reserved.

Attention please!

THE INFORMATION GIVEN IN THIS APPLICATION NOTE IS GIVEN AS A HINT FOR THE IMPLEMENTATION OF THE INFINEON TECHNOLOGIES COMPONENT ONLY AND SHALL NOT BE REGARDED AS ANY DESCRIPTION OR WARRANTY OF A CERTAIN FUNCTIONALITY, CONDITION OR QUALITY OF THE INFINEON TECHNOLOGIES COMPONENT. THE RECIPIENT OF THIS APPLICATION NOTE MUST VERIFY ANY FUNCTION DESCRIBED HEREIN IN THE REAL APPLICATION. INFINEON TECHNOLOGIES HEREBY DISCLAIMS ANY AND ALL WARRANTIES AND LIABILITIES OF ANY KIND (INCLUDING WITHOUT LIMITATION WARRANTIES OF NON-INFRINGEMENT OF INTELLECTUAL PROPERTY RIGHTS OF ANY THIRD PARTY) WITH RESPECT TO ANY AND ALL INFORMATION GIVEN IN THIS APPLICATION NOTE.

Information

For further information on technology, delivery terms and conditions and prices please contact your nearest Infineon Technologies Office (www.infineon.com).

Warnings

Due to technical requirements components may contain dangerous substances. For information on the types in question please contact your nearest Infineon Technologies Office. Infineon Technologies Components may only be used in life-support devices or systems with the express written approval of Infineon Technologies, if a failure of such components can reasonably be expected to cause the failure of that life-support device or system, or to affect the safety or effectiveness of that device or system. Life support devices or systems are intended to be implanted in the human body, or to support and/or maintain and sustain and/or protect human life. If they fail, it is reasonable to assume that the health of the user or other persons may be endangered.

AN-IGBT-12-2013-V1.0-EN-055

Revision History: date 13-12-02, V1.0

Subjects: Application Note initialized

Authors: Charles Low Khai Yen, IFMY DC PMM DPC
Dr. Christian Kasztelan, IFAG IPC TD ICD

We Listen to Your Comments

Any information within this document that you feel is wrong, unclear or missing at all? Your feedback will help us to continuously improve the quality of this document. Please send your proposal (including a reference to this document) to: [Charles.Low@infineon.com]

Table of contents

1	Introduction.....	4
2	Characterization of warpage of TO-220 and TO-247 packages:	4
3	The reason behind using two types of isolation foil with different hardness coefficients.....	7
4	Application of screw mounting torque:	8
5	Heatsink Screw Mounting.....	9
6	The importance of a flat heatsink at the application circuit:	10
7	Examples of improper mounting and its consequences	12
7.1	Example 1	12
7.2	Example 2	12
7.3	Example 3	13
7.4	Example 4	13
8	Study of mounting torque towards $R_{th(j-c)}$ values:	15
9	Results.....	17
10	Recommendation:	20
11	Conclusion	20
12	References	20

1 Introduction

The aim of this document is to provide the reader hints and suggestion to:

1. Apply the optimum screw mounting torque value on IGBT discretes to have optimum $R_{th(j-c)}$ values without mechanically damaging the package.
2. Understand the impact of different isolation materials that have different hardness coefficients towards the $R_{th(j-c)}$ of the device when different mounting torque is applied.

2 Characterization of warpage of TO-220 and TO-247 packages:

The flatness of the back of the TO-220 and TO-247 package was monitored to ensure that the warpage due to different coefficient of thermal expansion of mold compound and lead frame is still within the 100 μ m range.

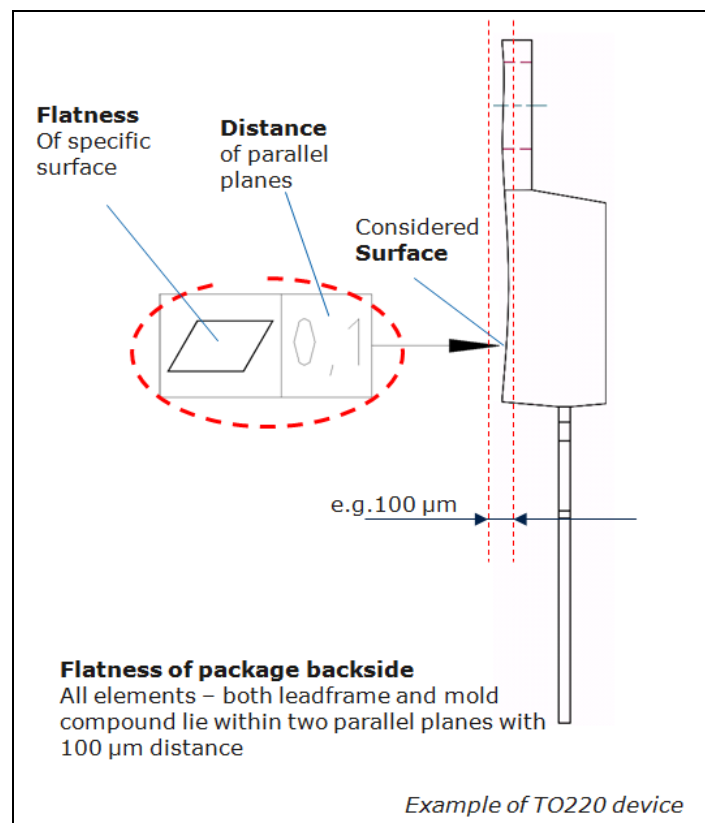

Figure 2.1: Warpage specification of a TO-220 package

IGBT devices in TO-220 and TO-247 packages were taken for flatness measurements using an optical scanner. A laser was used to scan the back of the package and the results of the scan were then graphed into a contour plot. Next, the surface flatness was evaluated along the contour line at the middle of the package. It was found that both packages had warpage values that were within specifications.

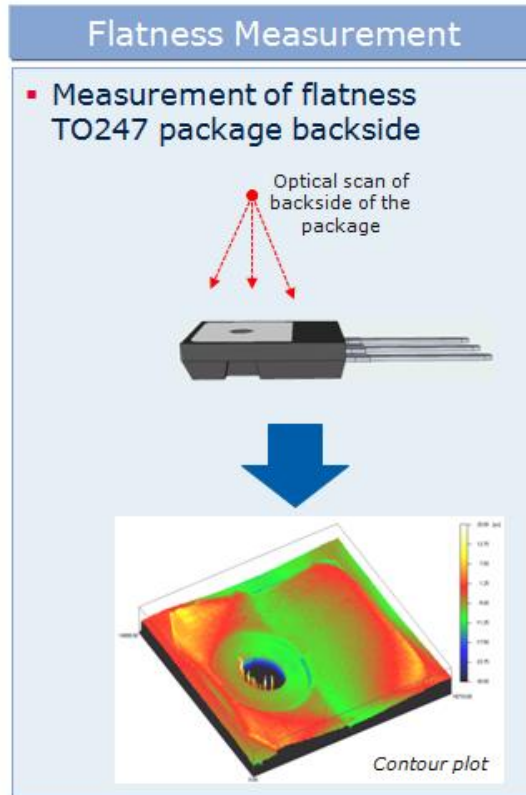

Figure 2.2: Contour plot of a TO-247 package after an optical scan

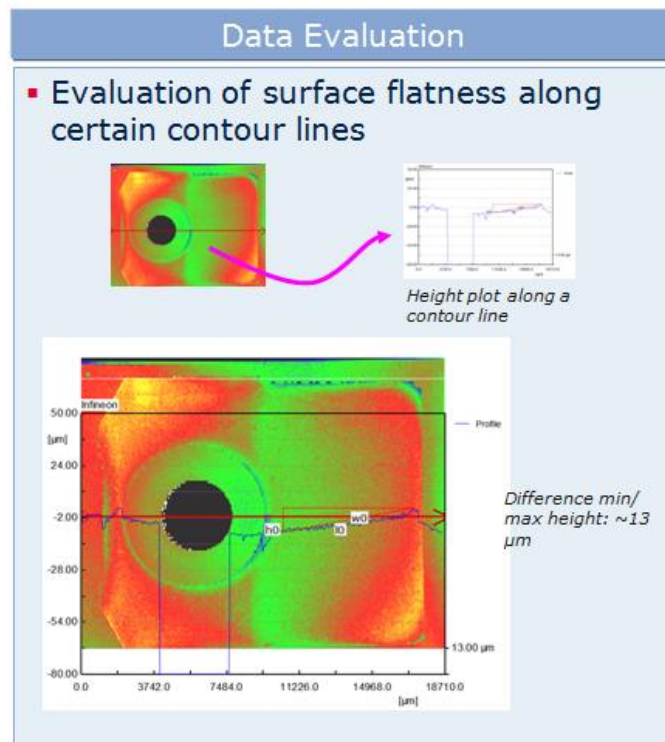

Figure 2.3: Evaluation of flatness along a contour line at the middle of the package

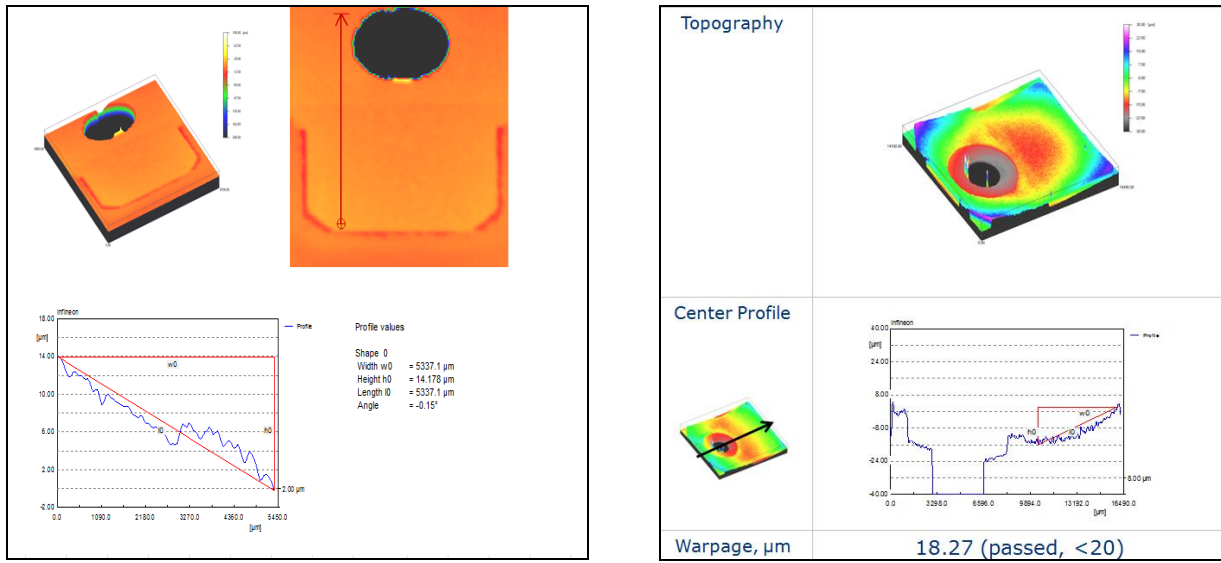

Figure 2.4: The warpage measurement from the contour line at the middle of a TO-220 and TO-247 package found that the warpage values were less than 20μm and were lower than the 100μm specifications.

The height from the contour line to the end of the length line showed that the maximum warpage was less than 20μm. The measurements showed that TO-220 and TO-247 package had warpage that were within specifications.

3 The reason behind using two types of isolation foil with different hardness coefficients

A softer isolation foil may leave a gap between the back of the device and the heatsink if too much force was concentrated on the screw hole of the device. As for a harder isolation foil, the force on the screw hole is evenly distributed over the surface of the foil due to stiffer characteristics. Therefore there would not be a gap between the back of the device and the heatsink.

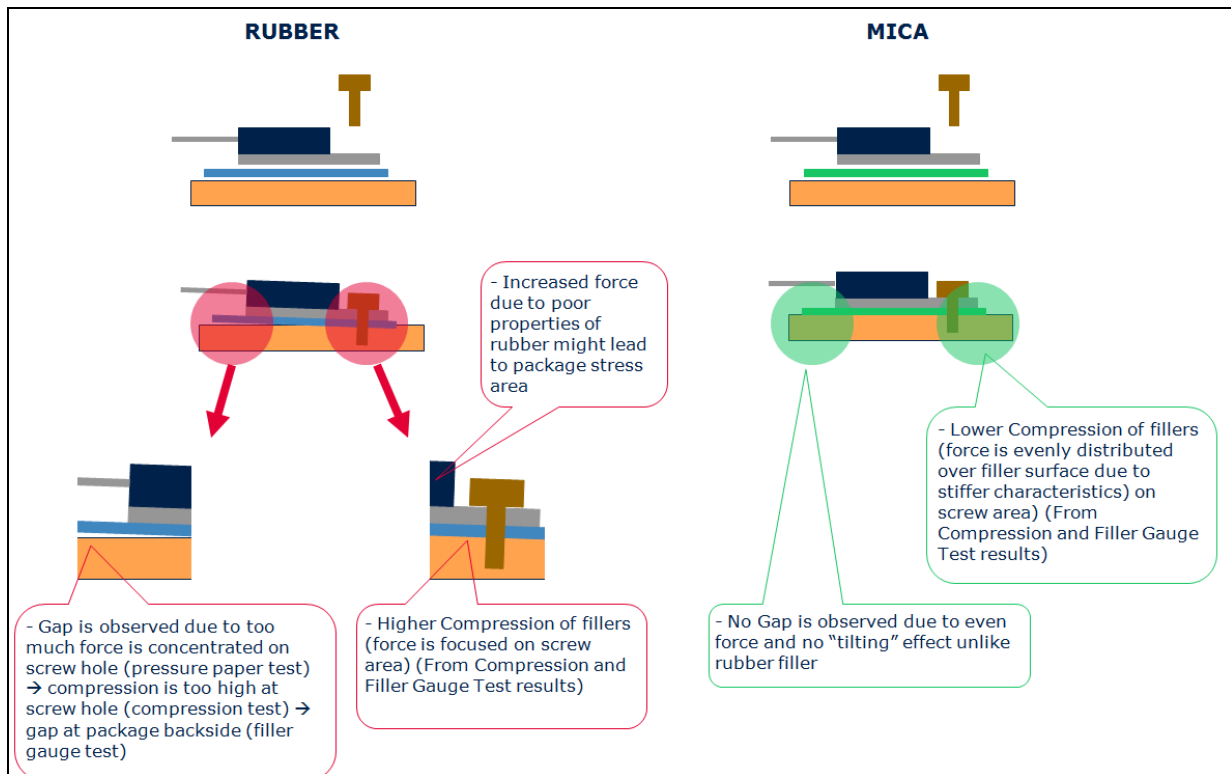

Figure 3.1: Comparison between soft and hard isolation material

4 Application of screw mounting torque:

In the manufacturing process, the lead frame and molding process had been optimized to ensure device warpage was as low as possible. With the flatness carefully monitored, the contact between the device package and the isolation foil could be as close as possible.

The contact areas between package and heatsink had been maximized by increasing the contact pressure between these two surfaces.

Increasing the mounting torque in the fastening screw will increase the contact areas and provide solid conduction heat-flow paths, which are more effective than conduction across an air gap.

Applying the appropriate mounting torque is an important factor in obtaining adequate pressure along the contact surfaces of the package and the heatsink, in order to minimize the contact thermal resistance.

If mounting torque is too low, the contact thermal resistance increases due to bad thermal contact under insufficient contact pressure.

If mounting torque is too high, the package head and mounting tab will deform so that the package may be lifted away from the heatsink, as shown in Figure 4.1. This also increases the contact thermal resistance.

Hence, appropriate mounting torque must be applied to produce minimal thermal resistance and avoid damaging the package or changing the device characteristics.

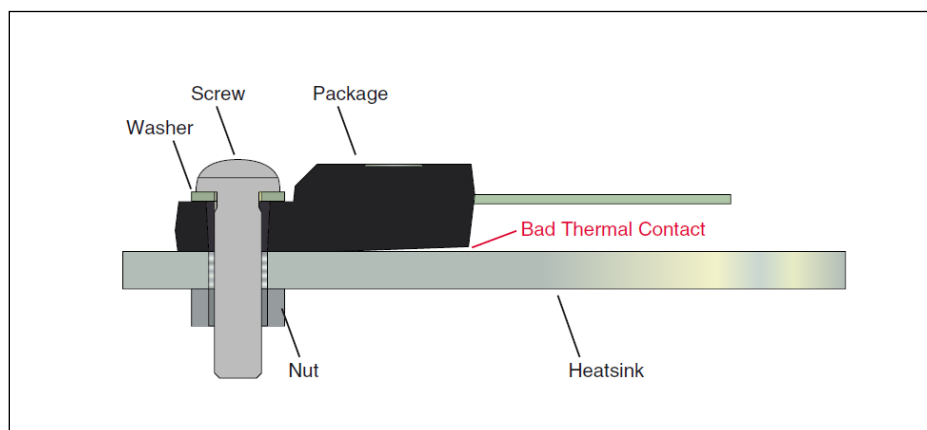

Figure 4.1: The device is lifted from the heatsink when the mounting torque is too high

5 Heatsink Screw Mounting

Screw mounting is a traditional assembly method accomplished by fastening a screw, nut and washer together.

- Self-tapping screws should not be used.
- A rectangular washer should be inserted between the screw head and the mounting tab. Care must be taken to ensure that the washer does not damage the plastic body of the package during the mounting process.

The screw should be tightened properly to ensure that the package makes good contact with the heatsink.

A recommendation for better control, one may use an electric screwdriver that has a dedicated controller that realizes high-accuracy screw tightening.

Electric screwdrivers have high repeatable torque accuracy and have variable speed adjustment that enables the selection of optimum screw tightening speed.

Figure 5.1 illustrates proper mounting methods for a TO-220 and a TO-220FP.

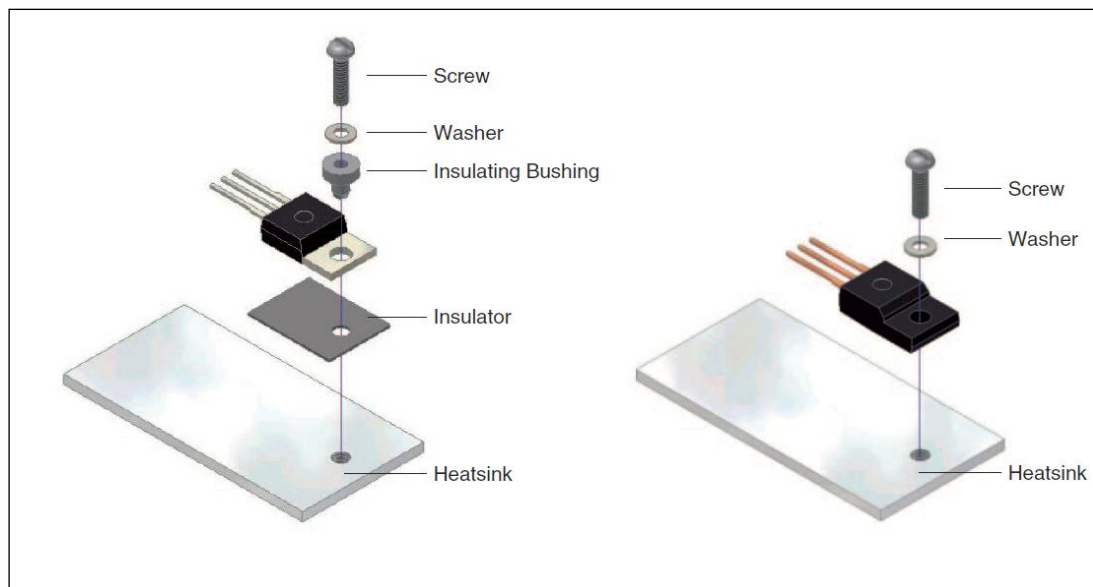

Figure 5.1: Mounting methods for a TO-220 and a TO-220FP

6 The importance of a flat heatsink at the application circuit:

If the surface of the heatsink at the application is not flat, there is a risk that the device would crack due to an uneven surface.

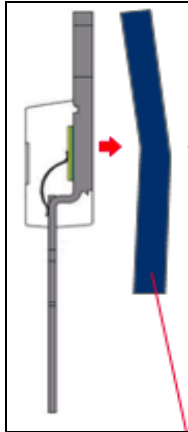

Figure 6.1: Illustration of a heatsink with uneven surface

When a device is mounted on a heatsink with uneven surface, the mold compound near the screw hole area would experience high mechanical stress and this would damage the device.

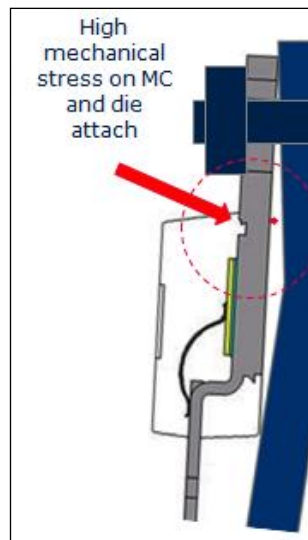

Figure 6.2: High mechanical stress on the mold compound when device is mounted on a heatsink with uneven surface

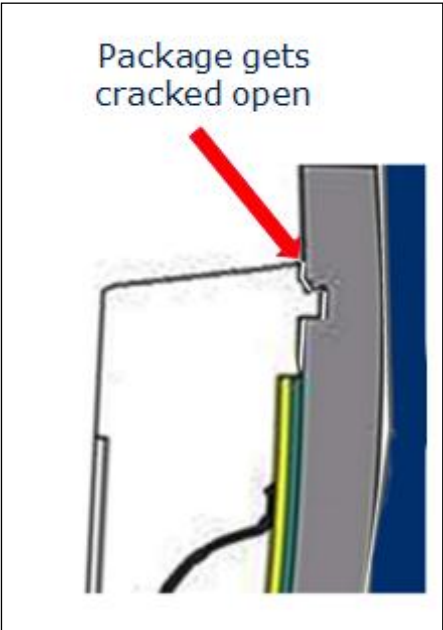

Figure 6.3: Package is cracked open near the screw hole area due to high mechanical stress

7 Examples of improper mounting and its consequences

7.1 Example 1

CSAM (C-Scanning Acoustic Microscopy) Delamination of moulding compound to die paddle at package head caused by external mechanical stress from too much screw tightening torque.

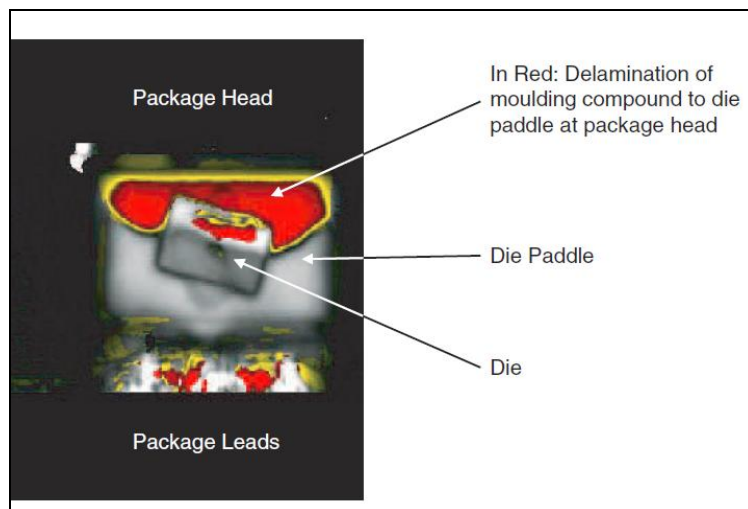

Figure 7.1: Delamination of mold compound from leadframe

7.2 Example 2

Cross-section showed vertical die crack caused by external mechanical stress due to too much screw tightening torque.

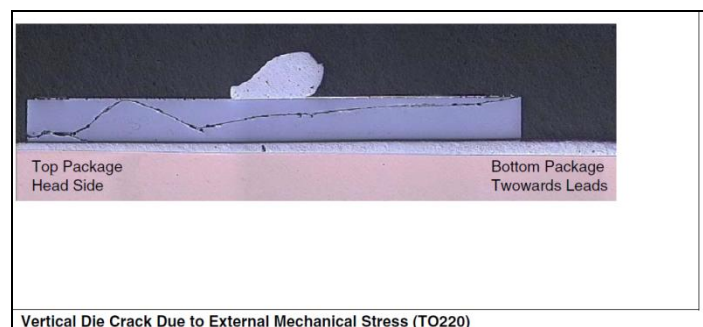

Figure 7.2: Die crack seen inside the package

7.3 Example 3

Impression on the package surface due to overtightening.

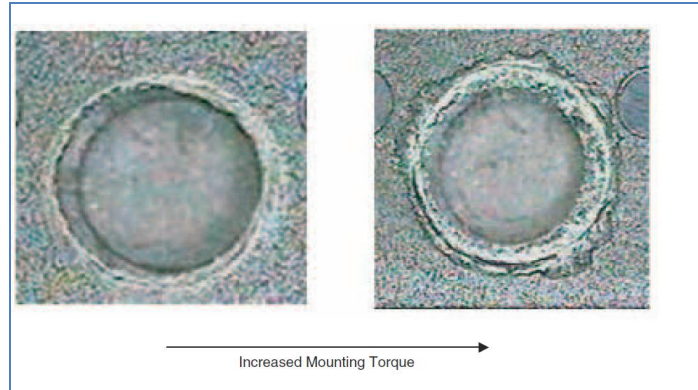

Figure 7.3: Damage on the surface of the mold compound due to too much screw torque applied

7.4 Example 4

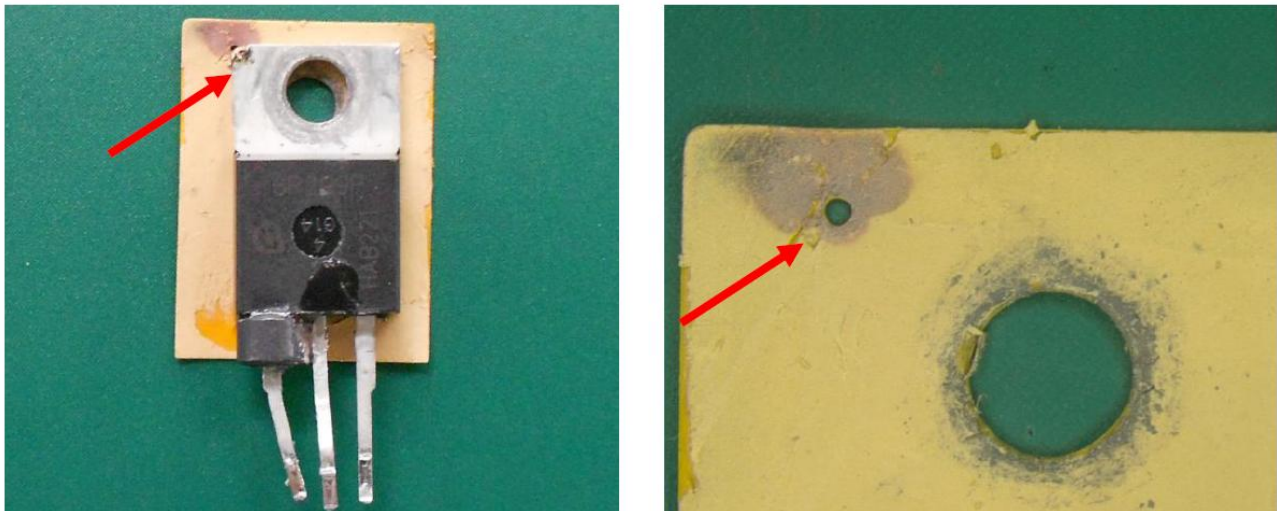

Figure 7.4: Failure analysis showed that the sharp corner of the heatsink had penetrated the isolation foil due to high screw mounting torque and this caused a short between the heatsink of the application and the drain of the device. The dotted lines on the picture on the right show the imprint of the heatsink of the device on the isolation foil due to application of too much screw mounting torque.

When the screw mounting torque is too high, the compression of the edge of the heatsink would penetrate the thin insulator foil, thus causing a short between the drain of the device and the heatsink of the application.

In summary, a large screw mounting torque would cause the following damages to the device:

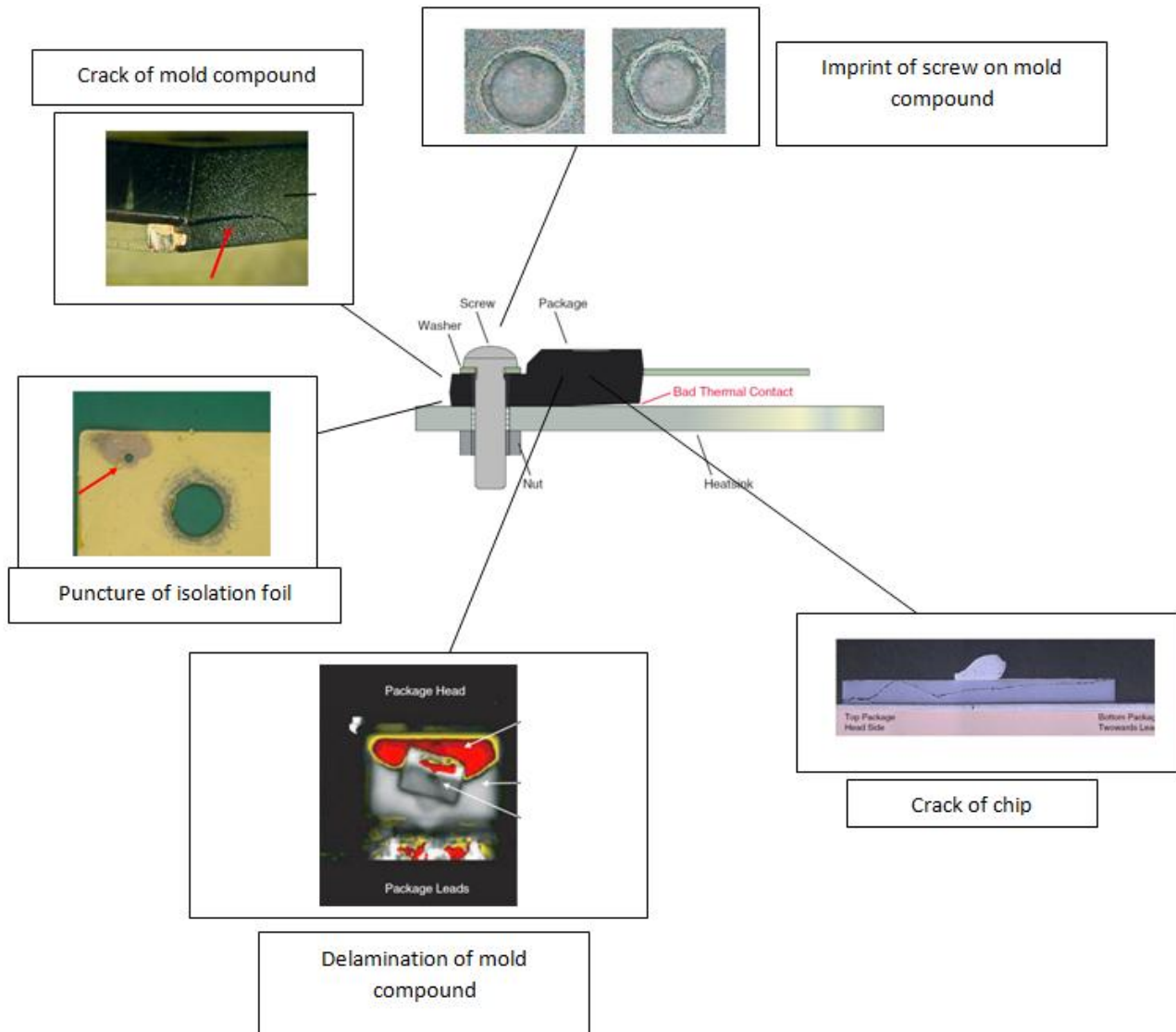

Figure 7.5: Catalogue of types of damages to the device due to too much screw mounting torque on a heatsink of the device

8 Study of mounting torque towards $R_{th(j-c)}$ values:





Technology type	Current Class	Part Number	Package type	Picture of package
Single IGBT	20A	IGP20N60H3	TO-220	 PG-TO-220-3 (TO-220AB)
	20A	IGW20N60H3	TO-247	 PG-TO247-3
	40A	IGY40N60H3	TOHC	
DuoPack™	75A	IKW75N60H3	TO-247	 PG-TO247-3
Reverse conducting	20A	IHY20N120R3	TOHC	
	20A	IHW20N120R3	TO-247	 PG-TO247-3

Table 8.1: Portfolio of devices used in the study of mounting torque against thermal resistance values

The devices selected for this study were from Infineon's bestseller portfolio of devices. This study covered packages with single chip and duo chips.

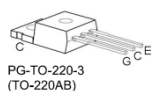
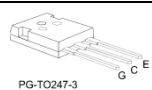
The objective of this study was to observe the impact of mounting torque towards devices with different chip sizes (small, mid and large), lead-frame thicknesses, and package sizes (TO-220, TO-247, and TO-280).

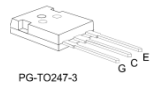
The $R_{th(j-c)}$ of these devices were measured with the use of two different isolation foils which was the Keratherm86/82 and Keratherm70/50. The following table shows the hardness coefficient of each foil:

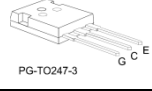
Isolation foil type	Hardness coefficient (Shore A)
Keratherm86/82	60-70
Keratherm70/50	80-90

Table 8.2: Hardness coefficient of isolation foils used

A dry mounting technique (no thermal grease) was used to study the impact of different isolation foils towards the $R_{th(j-c)}$ of the devices when different screw tightening torque was applied.

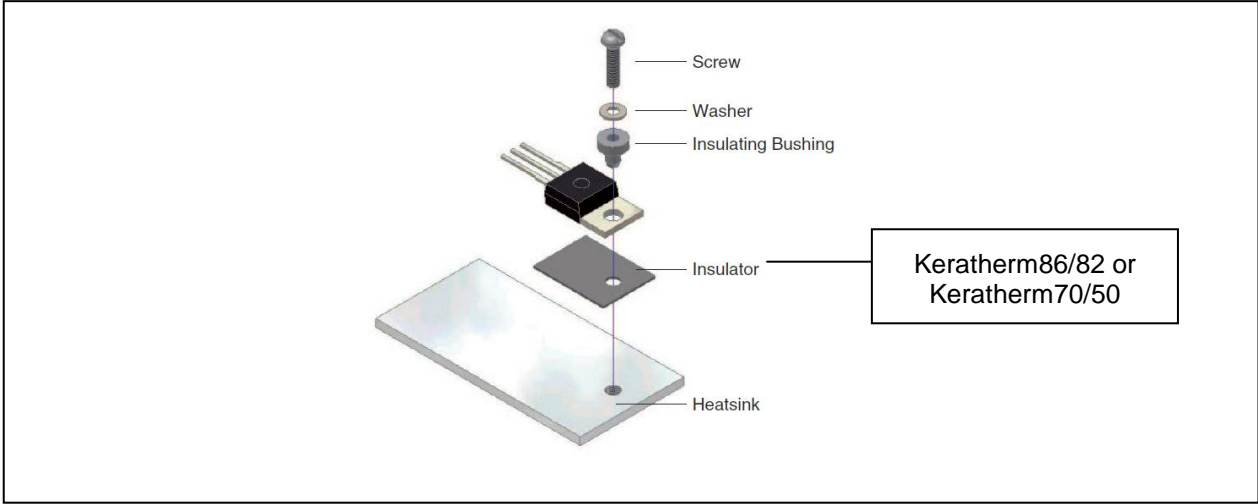

Figure 8.1: Setup of the device for measurement

9 Results

The device under testing (DUT) was first mounted as according to the picture above. Then $R_{th(j-c)}$ was measured with screw mounting torque from 0.4Nm until 1.2Nm.

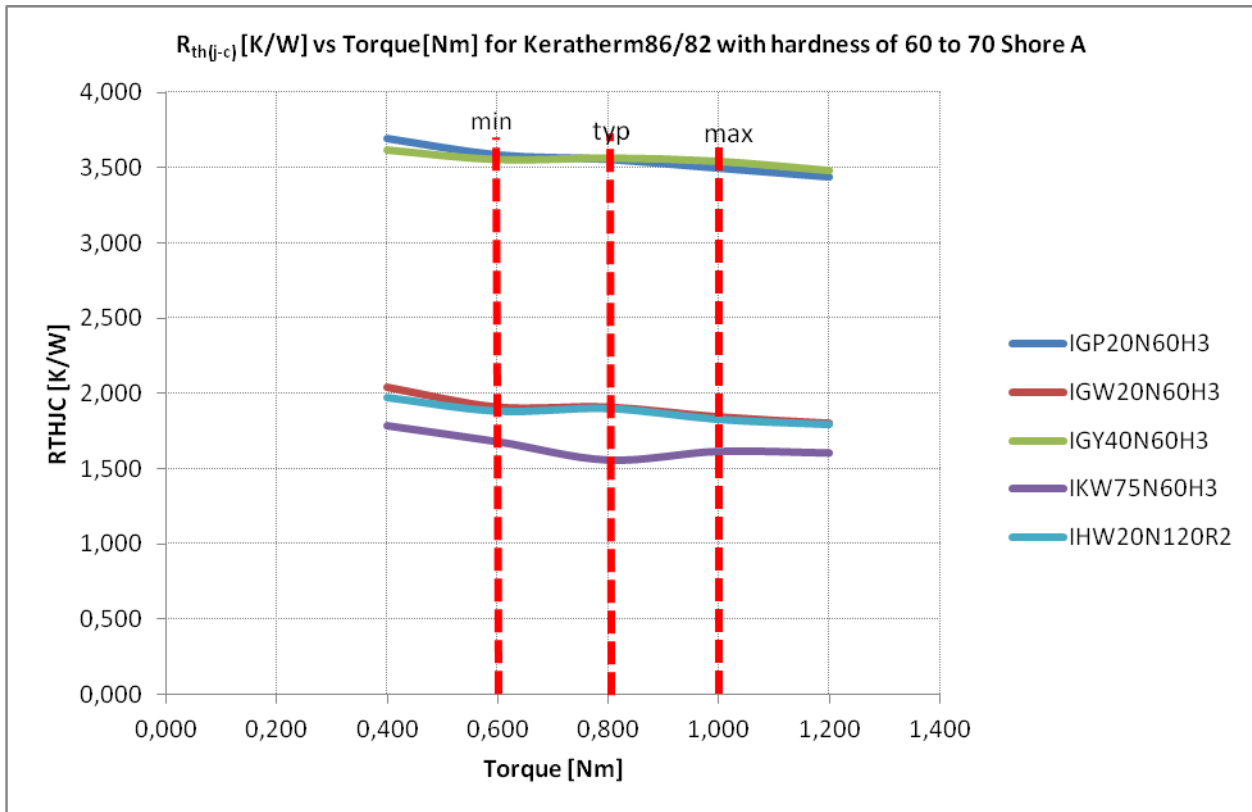

Figure 9.1: $R_{th(j-c)}$ vs Torque for isolation foil Keratherm86/82 with hardness coefficient of 60 to 70 Shore A

The chart above showed that devices in different packages that used the Keratherm86/82 isolation foil (60 to 70 shore A) had no significant changes in $R_{th(j-c)}$ when the screw tightening torque is in the 0.6 to 1.0Nm range. Therefore a typical screw tightening torque value of 0.8Nm was recommended.

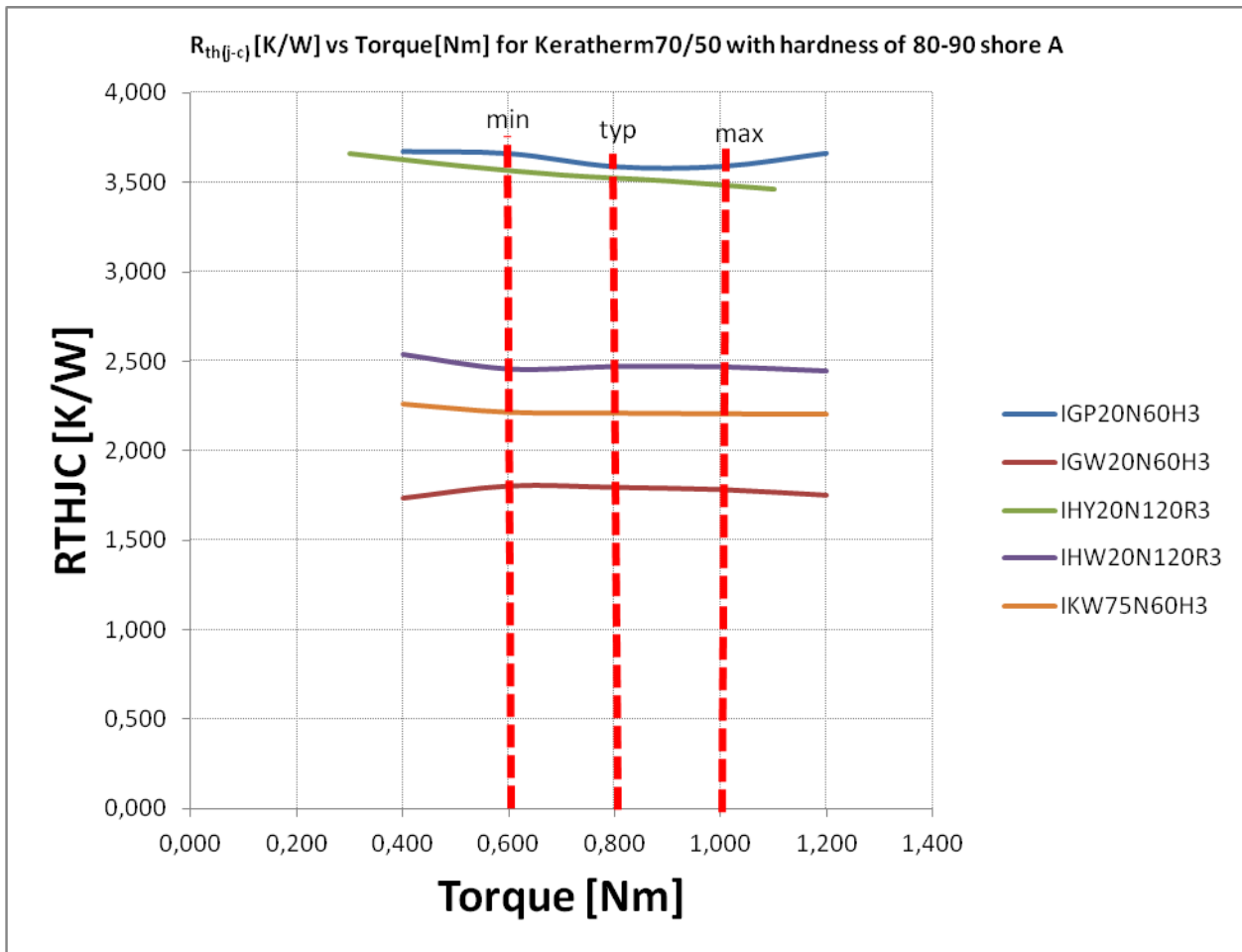

Figure 9.2: R_{th(j-c)} vs Torque for isolation foil Keratherm70/50 with hardness coefficient of 80 to 90 Shore A

The chart above showed that devices in different packages that used the Keratherm70/50 isolation foil (80 to 90 Shore A) had no significant changes in R_{th(j-c)} when the screw tightening torque is in the 0.6 to 1.0Nm range. Therefore a typical screw tightening torque value of 0.8Nm was recommended.

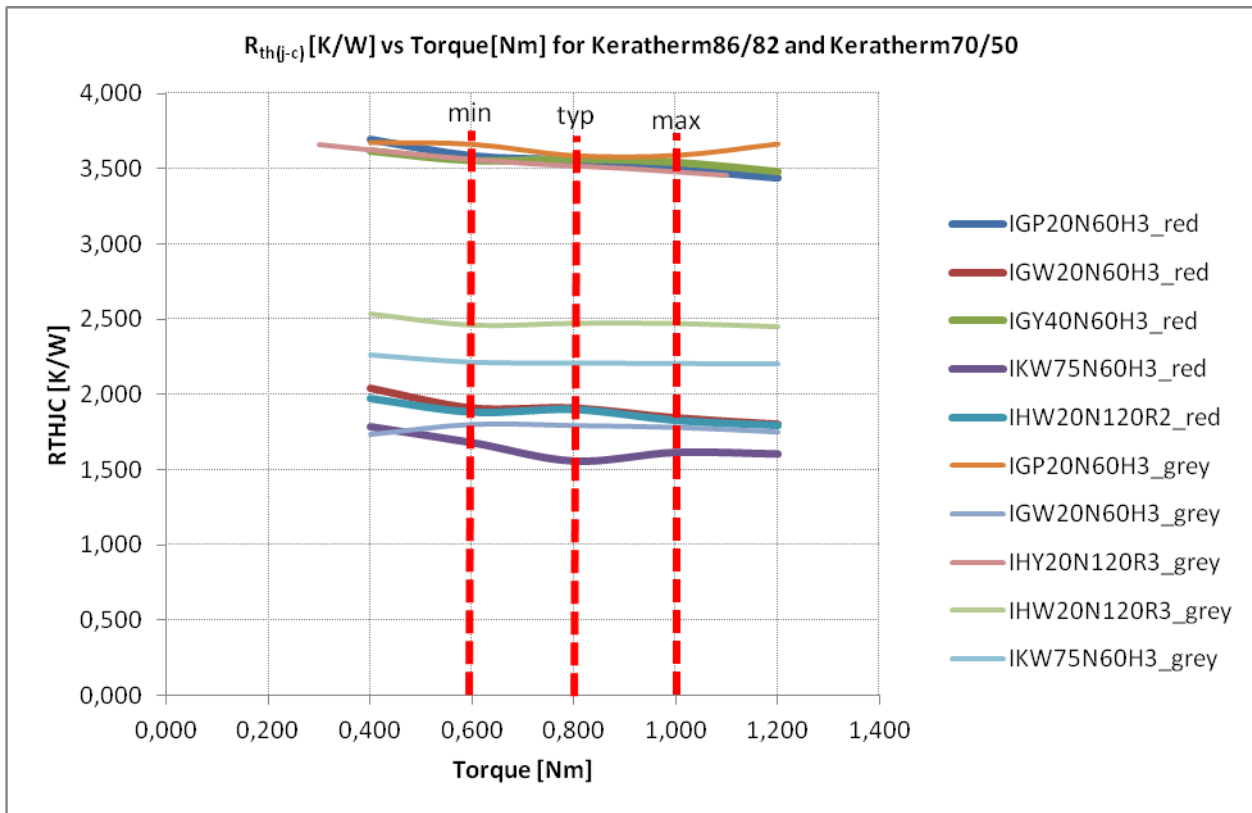

Figure 9.3: Combination of R_{th(j-c)} vs screw mounting torque for two types of isolation foils

The thickness of the isolation foil could be thinner after the screw was applied but there was no significant difference in R_{th(j-c)} between the 0.6 to 1Nm range.

10 Recommendation:

Therefore, the purpose of recommending a max limit in the graph above is to prevent the user from using too much screw tightening torque that would lead to mechanical damages at the device as catalogued in Example 4.

Also, the minimum limit was proposed to help the user find out the minimum screw tightening torque to be used to achieve optimum thermal resistance at the device. Below this lower limit, thermal resistance would be higher due to poor contact between the device and its heatsink.

11 Conclusion

This study had shown that there were no significant differences in $R_{th(j-c)}$ values for all the devices measured when the screw tightening torque was between 0.6 to 1Nm when two types of isolation foils with standard hardness were used.

The typical value of 0.8Nm was recommended to achieve optimum thermal contact and to prevent mechanical damage to the package of the devices.

12 References

- [1] Recommendations for Assembly of Infineon TO Packages retrieved from http://www.infineon.com/dgdl/Processing_TO.pdf?folderId=db3a304313b8b5a60113cee8763b02d7&fileId=db3a30431936bc4b0119385051725a2e
- [2] Datasheets of T0220 package retrieved from <http://www.infineon.com/cms/en/product/igbts/IGP20N60H3/productType.html?productType=db3a304425afcf6a0126b2ce988f23a2>