

## Features

- Ultra small package: 1.0x0.6x0.5mm
- Ultra low capacitance: 30pF typical
- Ultra low leakage: nA level
- Low operating voltage:  $\pm 5V$
- Low clamping voltage
- 2-pin leadless package
- Complies with following standards:
  - – IEC 61000-4-2 (ESD) immunity test
    - Air discharge:  $\pm 30kV$
    - Contact discharge:  $\pm 30kV$
  - – IEC61000-4-5 (Lightning)18A (8/20 $\mu s$ )
- RoHS Compliant
- Lead Finish: NiPdAu

## Mechanical Characteristics

- Package: DFN1006-2 (0402)
- Lead Finish: Matte Tin
- Case Material: "Green" Molding Compound.
- Moisture Sensitivity: Level 3 per J-STD-020
- Terminal Connections: See Diagram Below
- Shipping Qty : 10000pcs or 12000pcs/7Inch Tape & Reel

## Applications

- Cellular Handsets and Accessories
- Personal Digital Assistants
- Notebooks and Handhelds
- Portable Instrumentation
- Digital Cameras
- Peripherals
- Audio Players
- Keypads, Side Keys, LCD Displays

## Dimensions and Pin Configuration

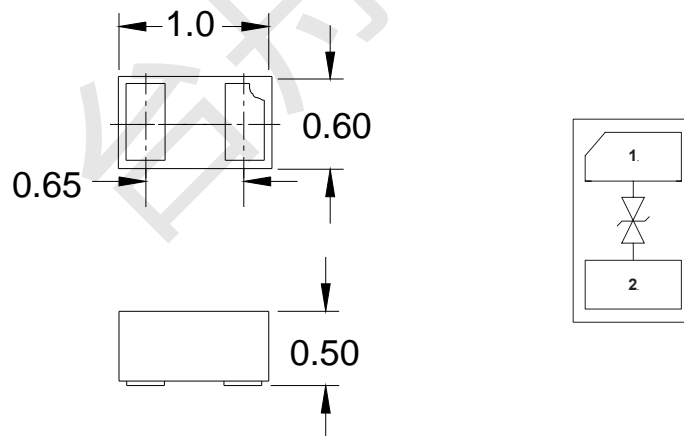

**Absolute Maximum Ratings** (Tamb=25°C unless otherwise specified)

Parameter	Symbol	Value	Unit
Peak Pulse Power (8/20μs)	Ppk	140	W
Peak Pulse Current (8/20μs)	Ipp	18	A
ESD per IEC 61000-4-2 (Air)	VESD	±30	kV
ESD per IEC 61000-4-2 (Contact)		±30	
Operating Temperature Range	TJ	-55 to +125	°C
Storage Temperature Range	Tstg	-55 to +150	°C

**Electrical Characteristics** (TA=25°C unless otherwise specified)

Parameter	Symbol	Min	Typ	Max	Unit	Test Condition
Reverse Working Voltage	VRWM			5	V	
Breakdown Voltage	VBR	6			V	IT = 1mA
Reverse Leakage Current	IR			0.08	uA	VRWM = 5V
Clamping Voltage	VC		8.7	8.7	V	Ipp=1A(8x 20us pulse)
Clamping Voltage	VC		8.7	8.7	v	Ipp=18A(8x 20us pulse)
Junction Capacitance	CJ		30		pF	VR = 0V, f = 1MHz

**Typical Performance Characteristics ( $T_A=25^\circ\text{C}$  unless otherwise Specified)**

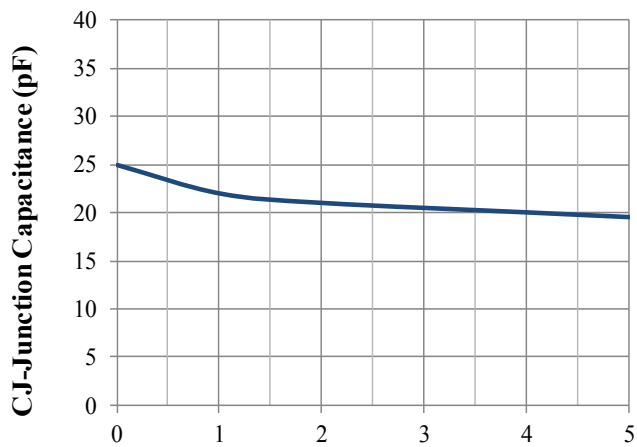

**Junction Capacitance vs. Reverse Voltage**

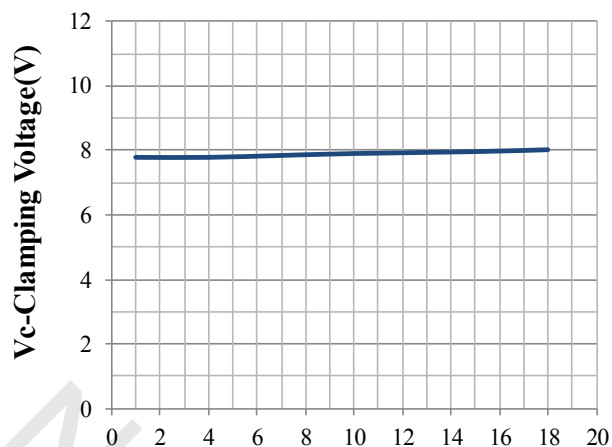

**Clamping Voltage vs. Peak Pulse Current**

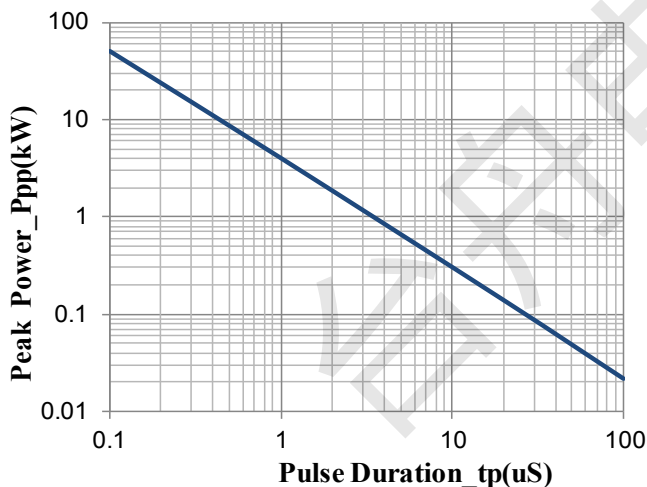

**Peak Pulse Power vs. Pulse Time**

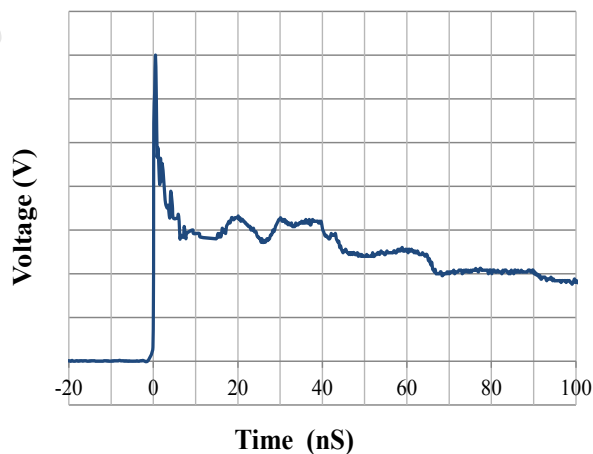

**IEC61000-4-2 Pulse Waveform**

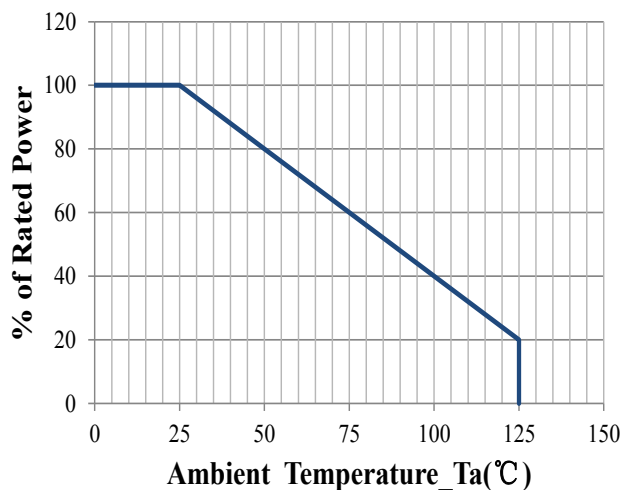

**Power Derating Curve**

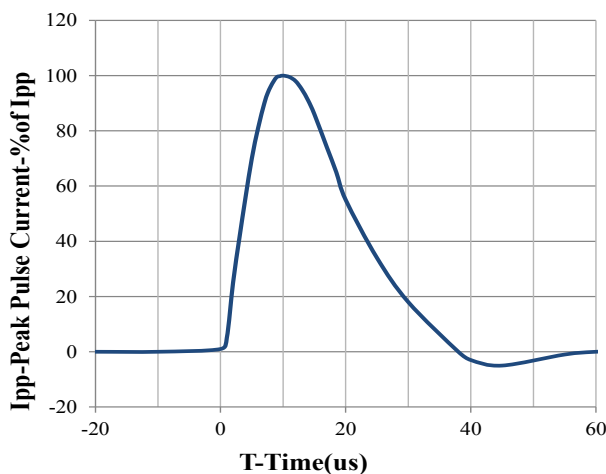

**8 X 20us Pulse Waveform**

**DFN1006-2 Package Outline Drawing (0402)**

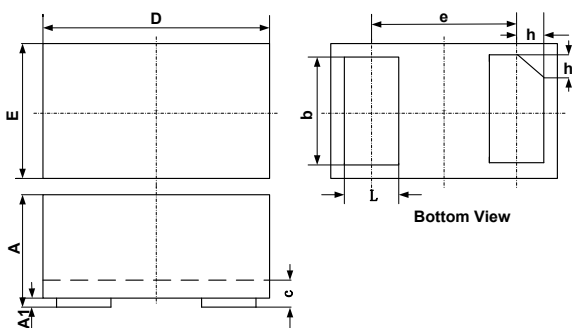

SYM	DIMENSIONS					
	MILLIMETERS			INCHES		
	MIN	NOM	MAX	MIN	NOM	MAX
A	0.45	0.50	0.55	0.018	0.020	0.022
A1	0.00	0.02	0.05	0.000	0.001	0.002
b	0.45	0.50	0.55	0.018	0.020	0.022
c	0.12	0.15	0.18	0.005	0.006	0.007
D	0.95	1.00	1.05	0.037	0.039	0.041
e	0.65 BSC			0.026 BSC		
E	0.55	0.60	0.65	0.022	0.024	0.026
L	0.20	0.25	0.30	0.008	0.010	0.012
h	0.07	0.12	0.17	0.003	0.005	0.007

**Suggested Land Pattern**

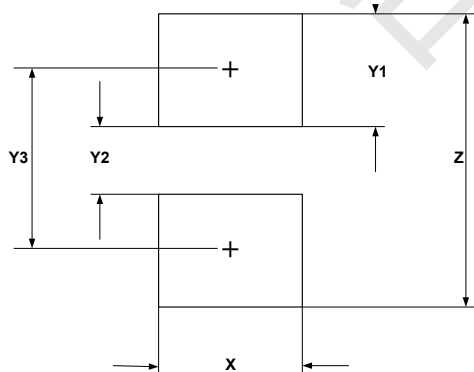

SYM	DIMENSIONS	
	MILLIMETERS	INCHES
X	0.60	0.024
Y1	0.50	0.020
Y2	0.30	0.012
Y3	0.80	0.032
Z	1.30	0.052