

**■ Features**

- This filter is characterized by small size, highly effective in noise suppression.
- High common mode impedance at noise band and low differential mode impedance at signal band. Due to the low differential mode impedance with high coupling factor, there is almost no distortion on high speed transmission of high resolution video signals.

**■ Applications**

- YLM Series is suited for use on the USB2.0 line and IEEE1394 line of Notebook PC, LVDS lines of PC, LCD Monitor, PCI express, small digital AV equipment such as digital Camera and Free disk, MP3 player and Serial-ATA.

**■ Product Identification**

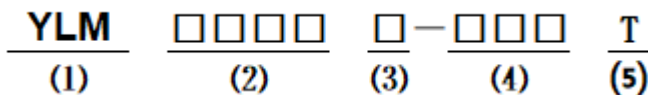

- (1) : Type
- (2) : Dimensions
- (3) : Identification Code
- (4) : Impedance
- (5) : Taping

**Shapes and Dimensions (Unit: mm)**

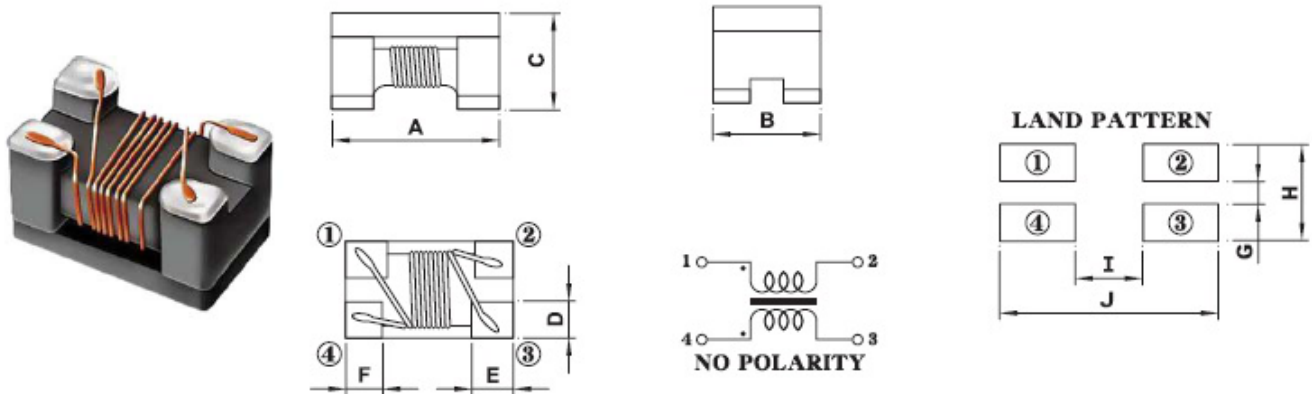

TYPE	A	B	C	D	E	F	G	H	I	J
YLM3225	3.2±0.2	2.5±0.2	2.2±0.2	0.90±0.1	0.80±0.1	0.80±0.1	0.90	2.50	2.20	4.00

**YLM3225 Series**

Part Number	Common mode Impedance (Ω) @100MHz	DC Resistance (Ω) Max	Rated Current (mA) max	Rated Volt. (Vdc)max.	Withstand Volt.(Vdc)max.	IR(MΩ) min.
YLM3225□-900T	90±25%	0.05	1000	50	125	10
YLM3225□-161T	160±25%	0.15	480	50	125	10
YLM3225□-271T	270±25%	0.25	450	50	125	10
YLM3225□-601T	600±25%	0.20	1000	50	125	10
YLM3225□-102T	1000±25%	0.30	400	50	125	10

**Recommended soldering temp.Graph**

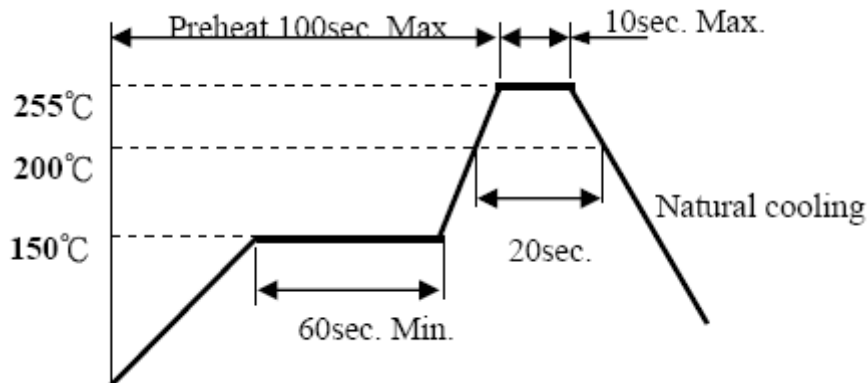

**Mechanical reliability**

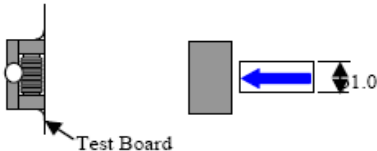
TEST	Specification & Requirement	Method Used
Solderability	The surface of terminal/pin tested shall be covered with new solder by 90%	Solder heat proof: Preheating: 150 ±10°C 60 seconds Soldering: 230 ±5°C for 3 ±1 sec
Solder Heat Resistance	Components should have not evidence of electrical and mechanical damage Impedance: within ±15% of initial value	Preheating: 150°C 60secs Solder temperature: 260±5°C Flux: rosin Dip time: 10±0.5 secs
Terminal strength	Series No.	F (Kg)
	YLM2012	0.5
	YLM3216/3225	1.0
	YLM4532	1.5
		Solder a chip to test substrate and then laterally apply a force in the arrow direction 

**Endurance Reliability**

TEST	Specification & Requirement	Method Used
Thermal Shock	Impedance change within ± 15% Without mechanical damage	-25°C, (30 mins) -> room temp. (5 mins) -> 125°C, (30 mins) -> room temp. (5 mins) 10 cycles
Humidity Resistance	Impedance change within ± 15% Without mechanical damage	Apply IDC current @ 60°C ambient Humidity: 80% Duration: 168 hrs
Low Temp. Storing	Impedance change within ± 15% Without mechanical damage	Storing Temp. -25 ±2 °C for total 168 +5/-0 hours
High Temp. Storing	Impedance change within ± 15% Without mechanical damage	Storing Temp. 125 ±2 °C for total 168 +5/-0 hours

**■ Taping Dimensions(Unit:mm)**

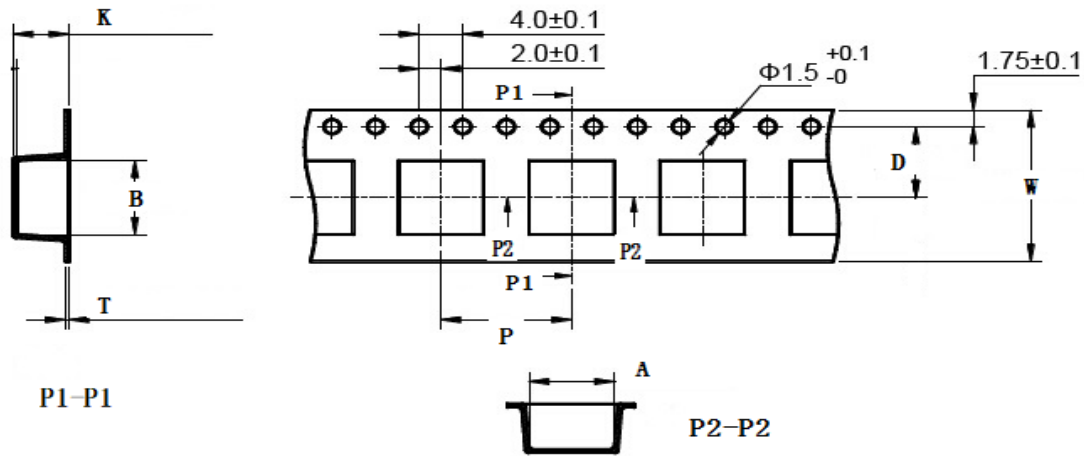

TYPE	W	A	B	D	P	K	T	MPQ
YLM3225	8.0±0.2	2.88±0.1	3.65±0.1	3.5±0.05	4.0±0.1	2.50±0.1	0.26±0.05	2000

**■ Reel Dimensions(Unit:mm)**

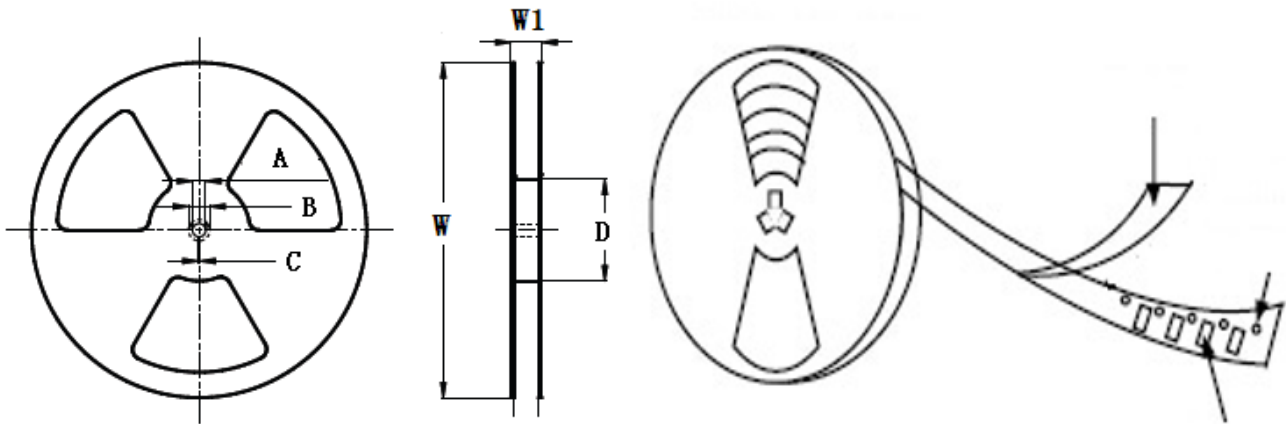

TYPE	W	W1	A	B	C	D
YLM3225	178±2.0	9.00±0.50	4.3±0.20	5.0±0.10	3.0±0.10	60±2.0

**Direction of rolling**

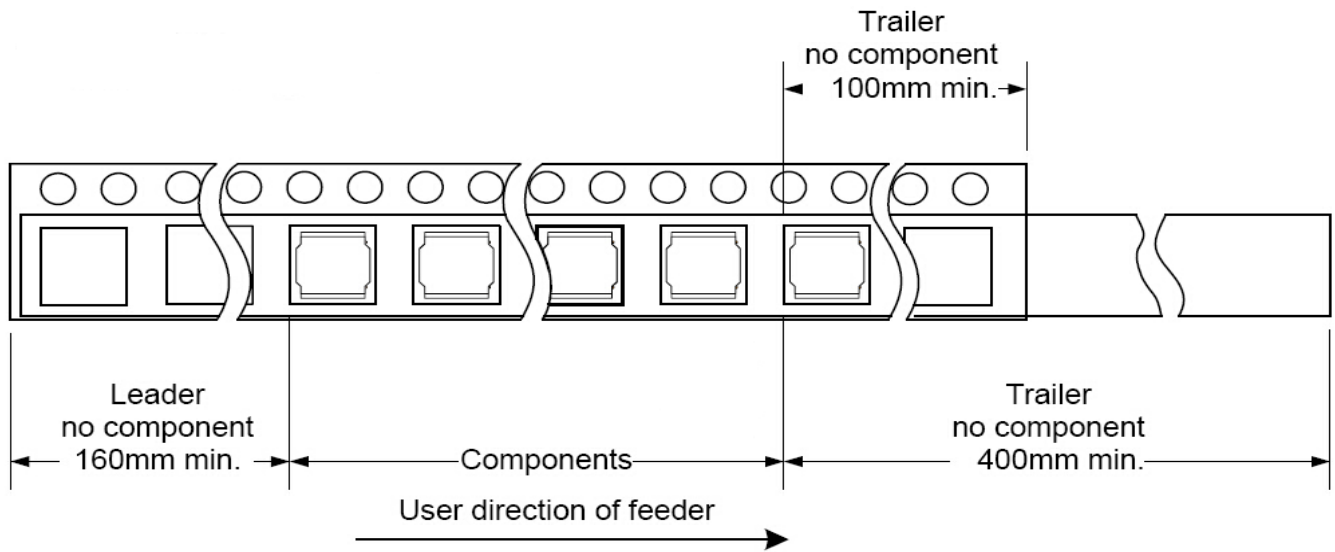

**Cover tape peel off condition**

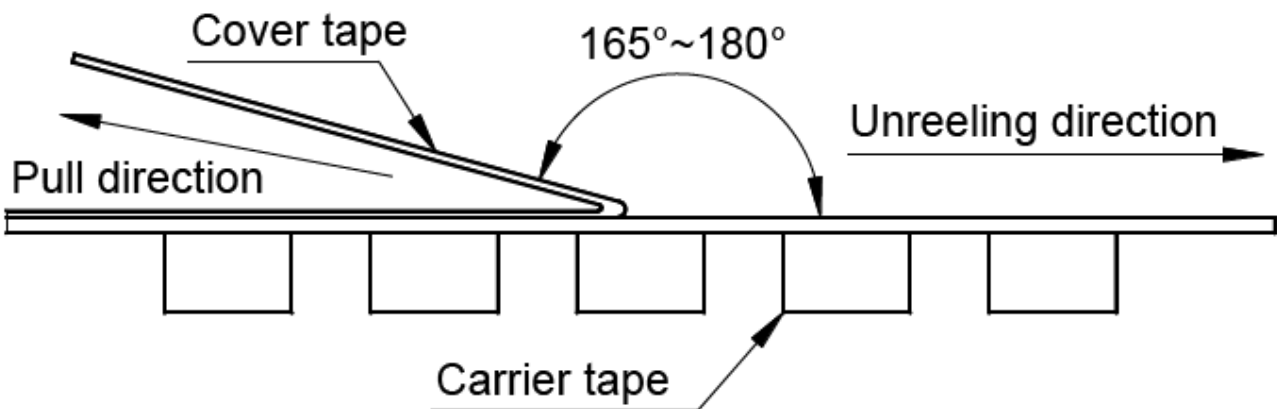

Cover tape peel force shall be 0.1N to 1.3N.

Reference peel speed 300±10mm/min.