

Features

- Low profile, height 6.5 mm
- High current up to 2500 mA
- Flammability corresponding to UL 94 V-0
- Ferrite toroidal core construction and class H enamelled copper wire
- Moisture sensitivity Level 1
- RoHS compliant, Halogen free are available
- Operating temperature: -40°C-125°C (temperature rise included)

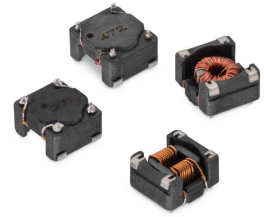

Application

- Current compensated choke for data and signal lines
- Power supply system
- Signal and sensor lines
- Suppression of common mode noise

Product Identification

KCMF 1080 - 120 Y
 ① ② ③ ④

- ① Series name: Wire Wound Common Mode Choke
- ② Chip Size: 10.0x8.7x6.5mm
- ③ Inductance: 120uH
- ④ Tolerance: ±40%

SHAPE AND DIMENSIONS

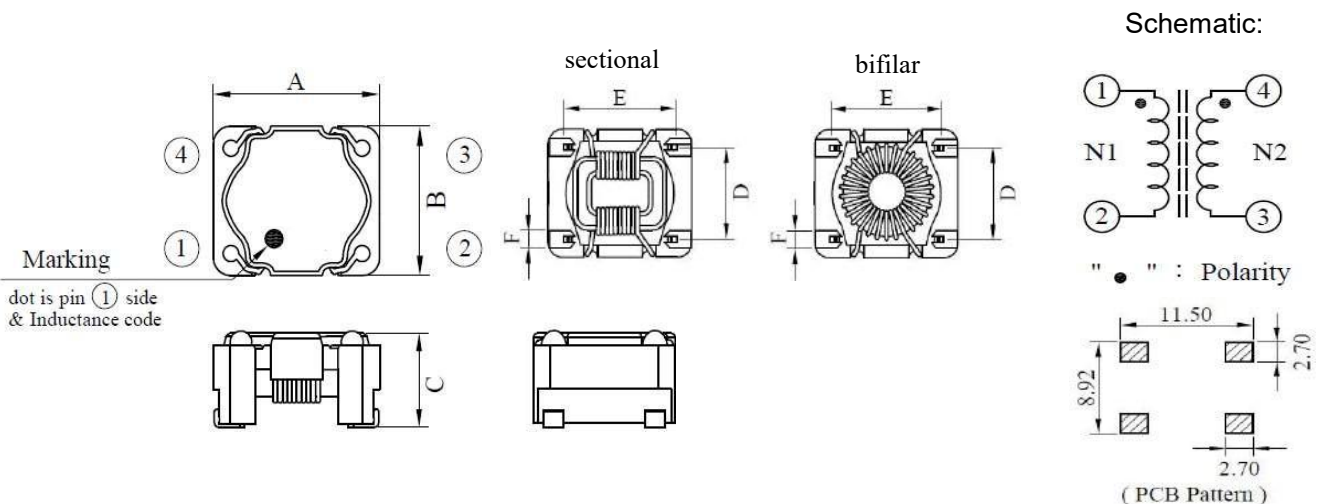

A(mm)	B(mm)	C(mm)	D(mm)	E(mm)	F(mm)
10.00±0.5	8.70±0.5	6.50 max.	6.22±0.1	7.62±0.1	1.40 ref.

SPECIFICATIONS

Part Number	Winding Style	Inductance (μH)	Peak Common Mode Impedance [Ω] Typical	Rated Current [A] Max.	DCR [Ω /line] Max.	Marking
KCMF1080-120Y	sectional	120 \pm 40%	460@30MHz	2.5	0.025	121
KCMF1080-221Y	sectional	220 \pm 40%	780@18MHz	2.2	0.032	221
KCMF1080-251Y	sectional	250 \pm 40%	970@15MHz	2.0	0.035	251
KCMF1080-471Y	sectional	470 \pm 40%	1750@15MHz	1.6	0.065	471
KCMF1080-102Y	sectional	1000 \pm 40%	3600@6.5MHz	0.95	0.18	102
KCMF1080-222Y	bifilar	2200 \pm 40%	7500@4.2MHz	0.75	0.30	222
KCMF1080-332Y	bifilar	3300 \pm 40%	8900@2.0MHz	0.65	0.36	332
KCMF1080-392Y	bifilar	3900 \pm 40%	9600@2.8MHz	0.52	0.54	392
KCMF1080-472Y	bifilar	4700 \pm 40%	13000@1.0MHz	0.35	0.72	472

- Inductance shown for each winding, measured at: 100KHz, 100mV
- Rated current that causes a 45°C temperature rise from 25°C ambient
- DC resistance measured @ 20°C
- Dielectric strength 1000VAC max between line to line
- Rated voltage: 80 VDC(42 VAC).
- Standard packing : tape and reel, 800pcs per 13" reel

TYPICAL ELECTRICAL CHARACTERISTICS

KCMF1080-120Y

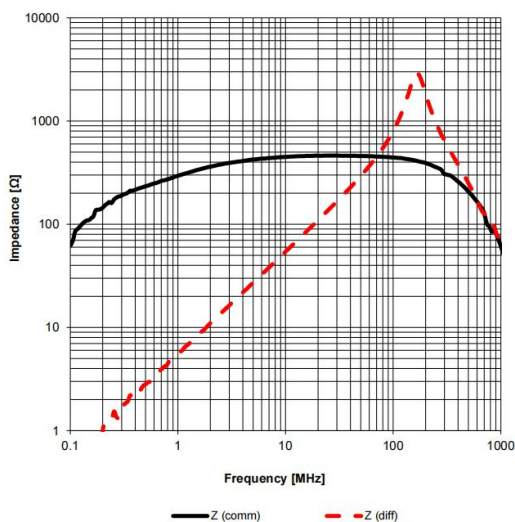

KCMF1080-221Y

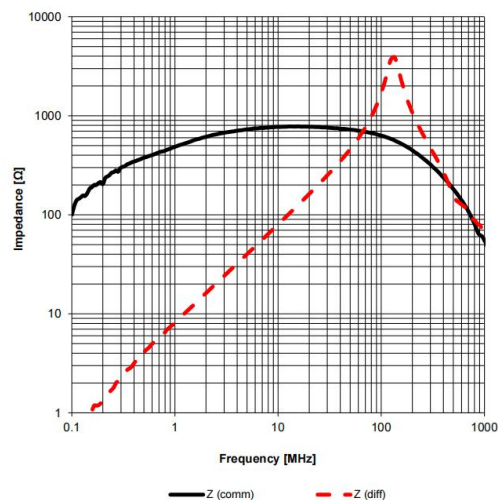

TYPICAL ELECTRICAL CHARACTERISTICS

KCMF1080-251Y

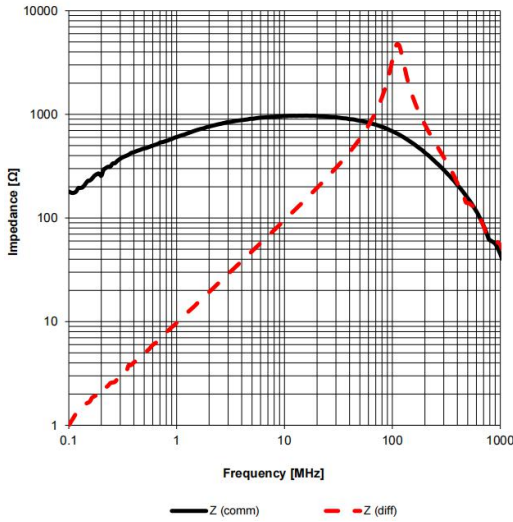

KCMF1080-471Y

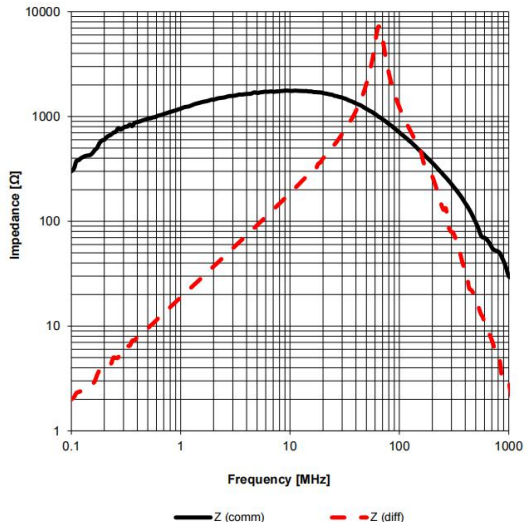

KCMF1080-102Y

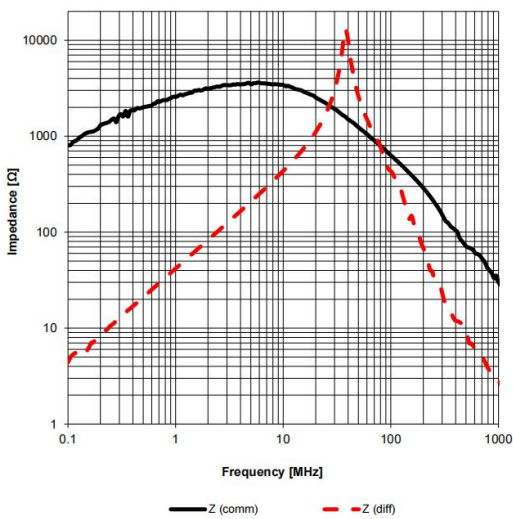

KCMF1080-222Y

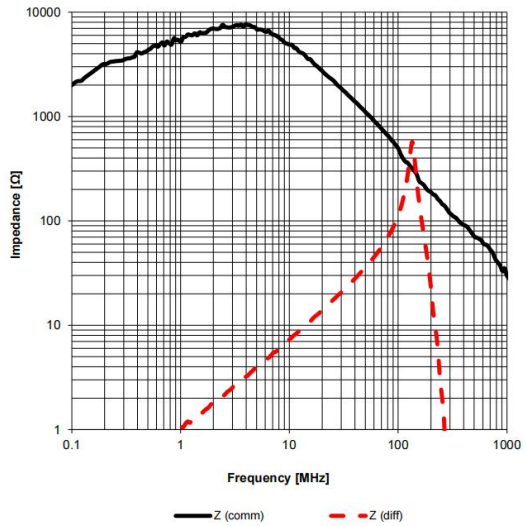

KCMF1080-332Y

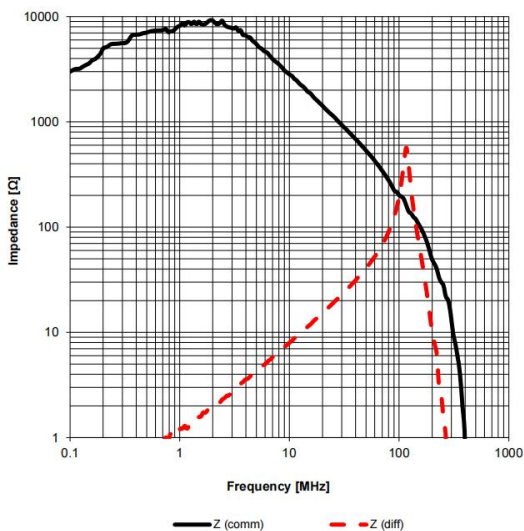

KCMF1080-392Y

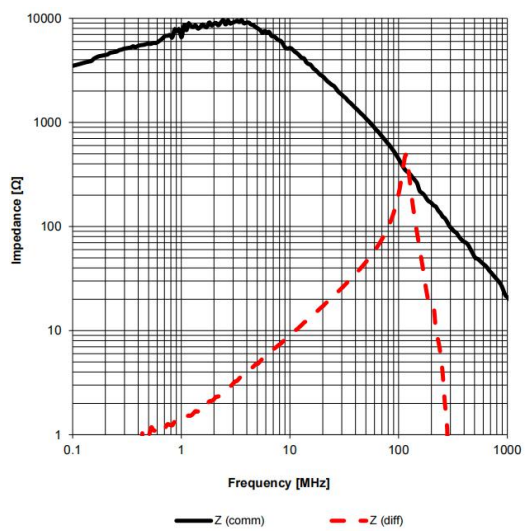

TYPICAL ELECTRICAL CHARACTERISTICS

KCMF1080-472Y

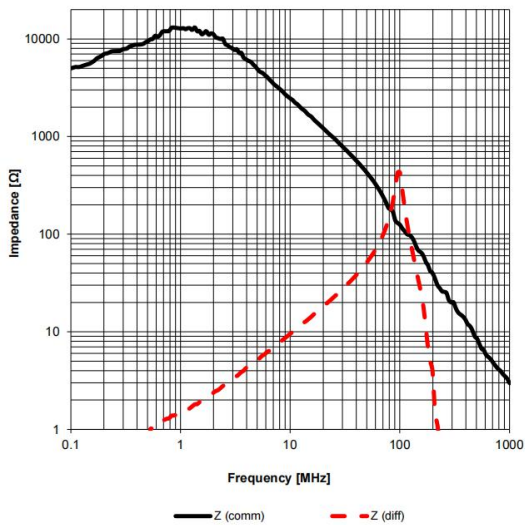

SOLDERING SPECIFICATION

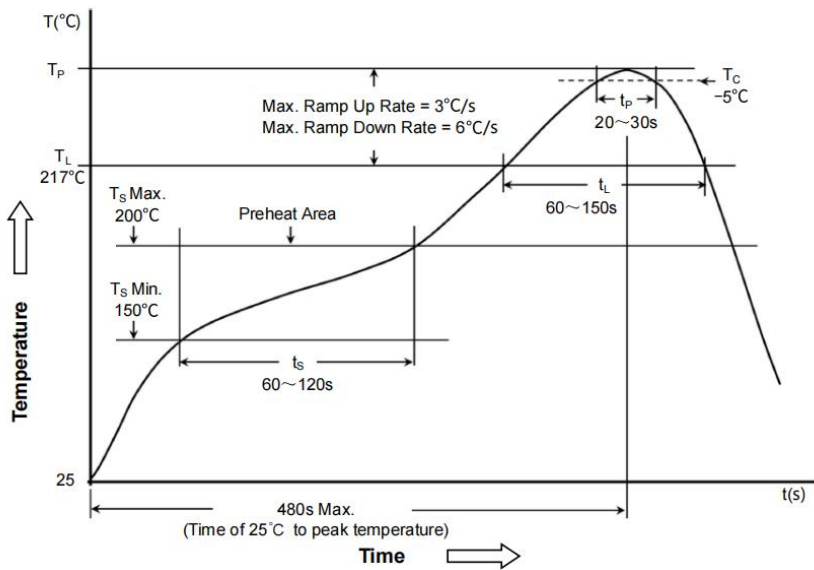

	Package Thickness	Package Volume		
		<350 mm ³	350~2000 mm ³	>2000 mm ³
PB-Free Assembly	<1.6mm	260 °C	260 °C	260 °C
	1.6~2.5mm	260 °C	250 °C	245 °C
	≥2.5mm	250 °C	245 °C	245 °C

- Reflow is referred to standard IPC/JEDEC J-STD-020D

NOTICE OF USE

- Product in packing storage condition : temperature 5~40℃, RH<=70%;
- storage of KONEN Electronic products for longer than 12 months is not recommended, Within other effects, the terminals may suffer degradation, resulting in bad solderability. Therefore, all products shall be used within the period of 12 months based on the day of shipment;
- Do not keep products in unsuitable storage conditions, such as areas susceptible to high temperatures, high humidity, dust or corrosion;
- Always handle products with care;
- Don't touch electrodes directly with bare hands as oil secretions may inhibit soldering. Always ensure optimum conditions for soldering;
- When this product will be used on a similar or new project to the original one, sometimes it might be unable to satisfy the specifications due to different condition of usage;
- This inductor itself does not have any protective function in abnormal condition, such as overload, short-circuit, open-circuit conditions, etc. Therefore, it shall be confirmed that there is no risk of smoke, fire, dielectric withstand voltage, insulation resistance, etc., or use in abnormal conditions protective devices or protection circuit in the end product;
- Hi-Pot test with higher voltage than spec value will damage insulating material and shorten its life;
- If using in potting compound, the magnet wire coating might be damaged, please consult with us;
- Refrain from rinsing coils. If necessary, please consult with us.