

AP4407C

P-Channel Enhancement Mosfet

Feature

- -30V,-12A
 $R_{DS(ON)} < 14m\Omega @ V_{GS} = -10V$ TYP:10.5 m Ω
 $R_{DS(ON)} < 19m\Omega @ V_{GS} = -4.5V$ TYP:15 m Ω
- Trench DMOS Power MOSFET
- Fast Switching
- Exceptional on-resistance and maximum DC current capability

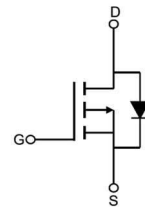

Schematic diagram

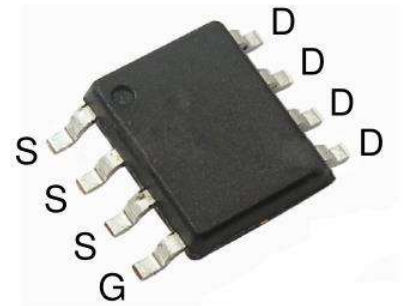

SOP-8

Application

- DC/DC Converter
- Load Switch for Portable Devices
- Battery Switch

Package Marking and Ordering Information

Device Marking	Device	Device Package	Reel Size	Tape width	Quantity (PCS)
4407C	AP4407C	SOP-8	13 inch	-	4000

ABSOLUTE MAXIMUM RATINGS ($T_a = 25^\circ\text{C}$ unless otherwise noted)

Parameter	Symbol	Value	Unit
Drain-Source Voltage	V_{DS}	-30	V
Gate-Source Voltage	V_{GS}	± 20	V
Continuous Drain Current ($T_a = 25^\circ\text{C}$)	I_D	-12	A
Continuous Drain Current ($T_a = 100^\circ\text{C}$)	I_D	-8.4	A
Pulsed Drain Current ⁽¹⁾	I_{DM}	-50	A
Singel Pulsed Avalanche Energy ⁽⁴⁾	E_{AS}	100	mJ
Power Dissipation	P_D	3.7	W
Thermal Resistance from Junction to Ambient	$R_{\theta JA}$	42.8	$^\circ\text{C}/\text{W}$
Junction Temperature	T_J	150	$^\circ\text{C}$
Storage Temperature	T_{STG}	-55~ +150	$^\circ\text{C}$

MOSFET ELECTRICAL CHARACTERISTICS($T_a=25^{\circ}\text{C}$ unless otherwise noted)

Parameter	Symbol	Test Condition	Min	Type	Max	Unit
Static Characteristics						
Drain-source breakdown voltage	$V_{(BR)DSS}$	$V_{GS} = 0V, I_D = -250\mu A$	-30	-	-	V
Zero gate voltage drain current	I_{DSS}	$V_{DS} = -30V, V_{GS} = 0V$	-	-	-1	μA
Gate-body leakage current	I_{GSS}	$V_{GS} = \pm 20V, V_{DS} = 0V$	-	-	± 100	nA
Gate threshold voltage ⁽²⁾	$V_{GS(th)}$	$V_{DS} = V_{GS}, I_D = -250\mu A$	-1	-1.5	-2.5	V
Drain-source on-resistance ⁽²⁾	$R_{DS(on)}$	$V_{GS} = -10V, I_D = -10A$	-	10.5	14	m Ω
		$V_{GS} = -4.5V, I_D = -5A$	-	15	19	
Dynamic characteristics						
Input Capacitance	C_{iss}	$V_{DS} = -15V, V_{GS} = 0V, f = 1MHz$	-	2863	-	pF
Output Capacitance	C_{oss}		-	349	-	
Reverse Transfer Capacitance	C_{rss}		-	237	-	
Switching characteristics						
Turn-on delay time	$t_{d(on)}$	$V_{DD} = -15V, I_D = -12A$ $V_{GS} = -10V, R_G = 2.5\Omega$	-	11.5	-	ns
Turn-on rise time	t_r		-	38.5	-	
Turn-off delay time	$t_{d(off)}$		-	89	-	
Turn-off fall time	t_f		-	19	-	
Total Gate Charge	Q_g	$V_{DS} = -15V, I_D = -10A,$ $V_{GS} = -10V$	-	54.8	-	nC
Gate-Source Charge	Q_{gs}		-	7.5	-	
Gate-Drain Charge	Q_{gd}		-	12.5	-	
Source-Drain Diode characteristics						
Diode Forward voltage ⁽²⁾	V_{DS}	$V_{GS} = 0V, I_S = -10A$	-	-	-1.2	V
Diode Forward current ⁽³⁾	I_S		-	-	-12	A

Notes:

1. Repetitive Rating: pulse width limited by maximum junction temperature
2. Pulse Test: pulse width $\leq 300\mu s$, duty cycle $\leq 2\%$
3. Surface Mounted on FR4 Board, $t \leq 10$ sec
4. $L = 0.5mH, V_{DD} = -15V, R_G = 25\Omega, T_J = 25^{\circ}\text{C}$

Test Circuit & Waveform

Gate Charge Test Circuit & Waveform

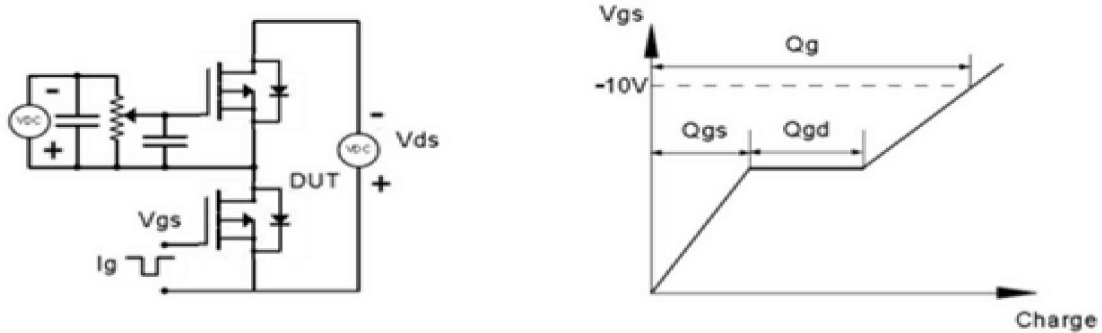

Resistive Switching Test Circuit & Waveforms

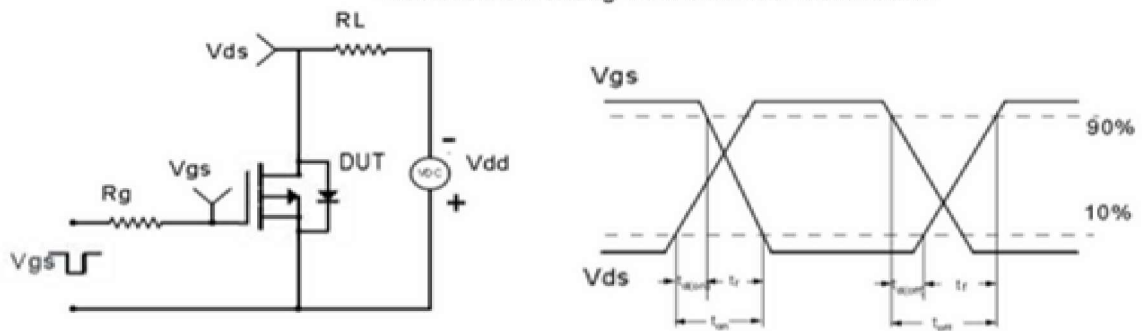

Unclamped Inductive Switching (UIS) Test Circuit & Waveforms

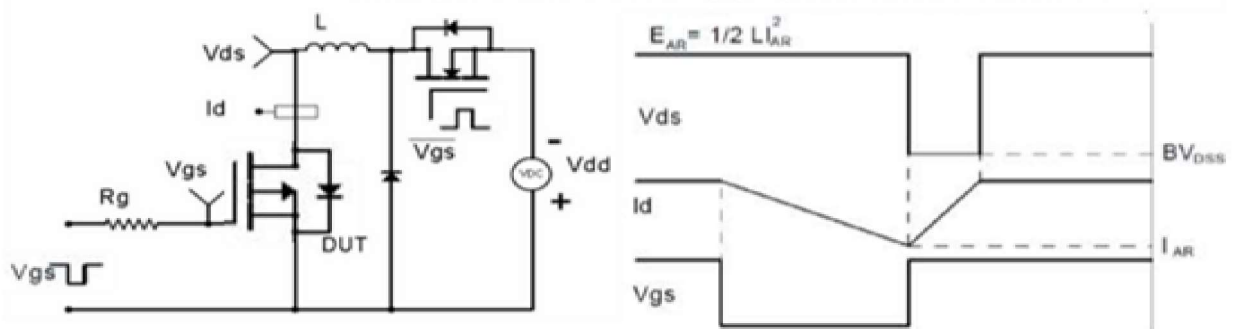

Diode Recovery Test Circuit & Waveforms

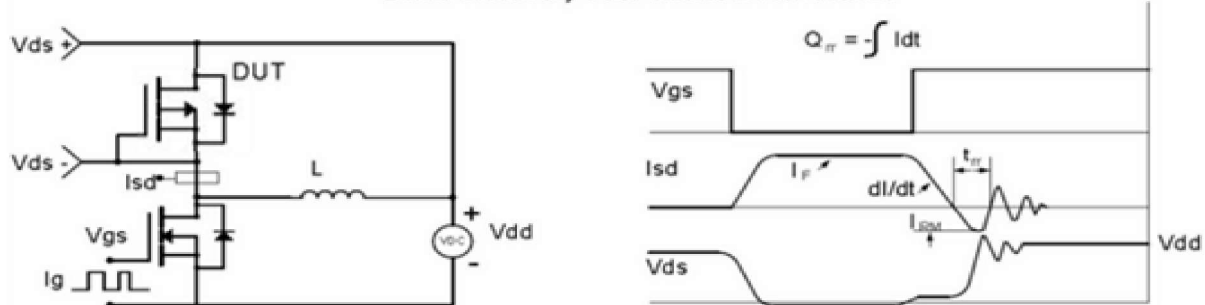

Typical Performance Characteristics

Fig.1 Power Dissipation Derating Curve

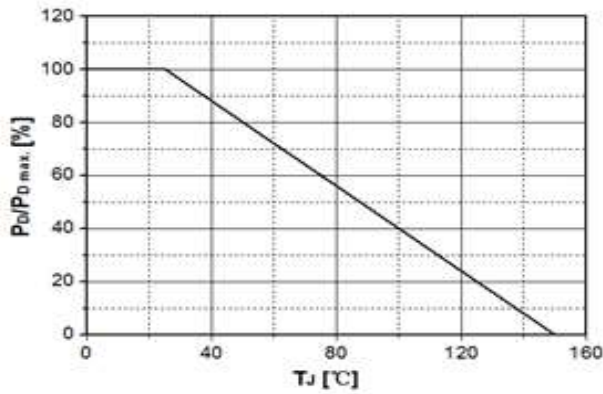

Fig.2 Avalanche Energy Derating Curve vs. Junction Temperature

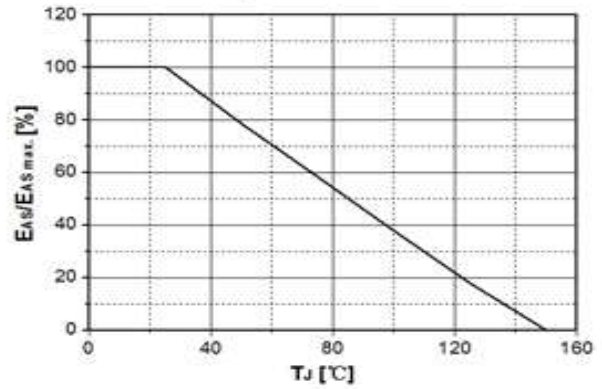

Fig.3 Typical Output Characteristics

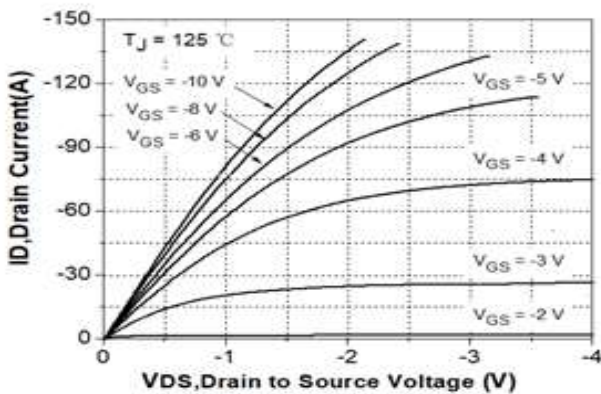

Fig. 4 Transconductance vs. Drain Current

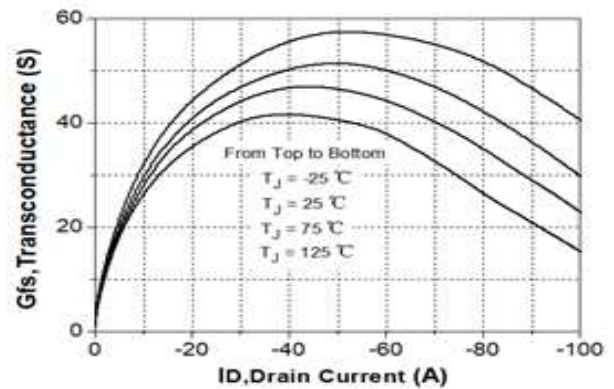

Fig.5 Typical Transfer Characteristics

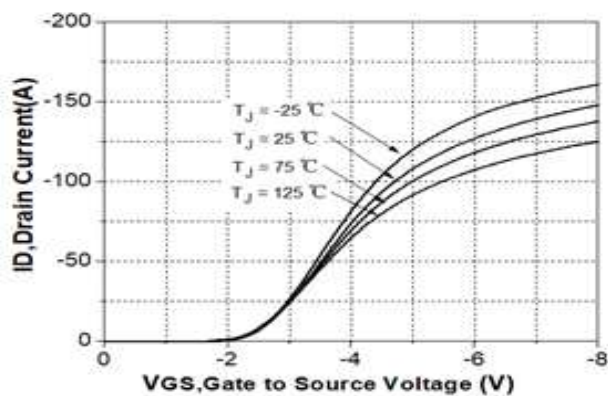

Fig. 6 State Resistance vs. Drain Current @-25°C

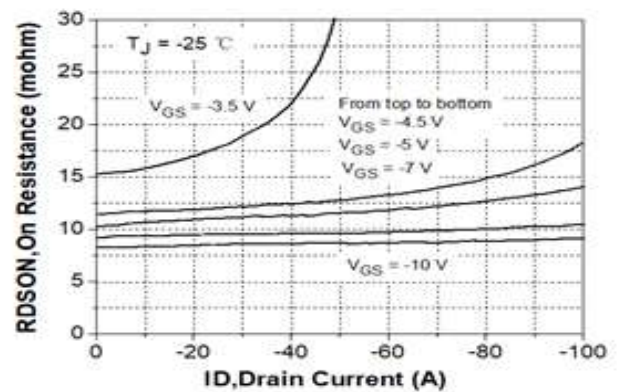

Fig.7 State Resistance vs. Drain Current @25°C

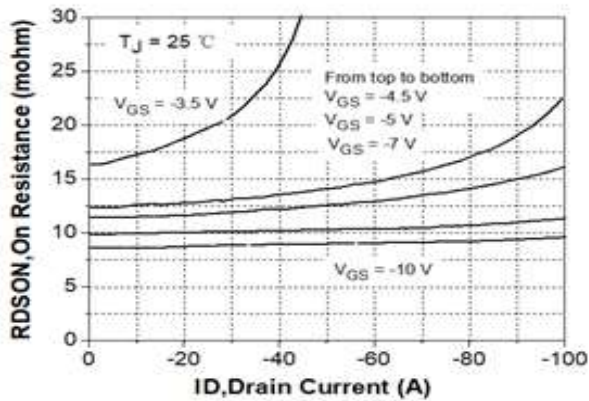

Fig. 8 State Resistance vs. Drain Current @125°C

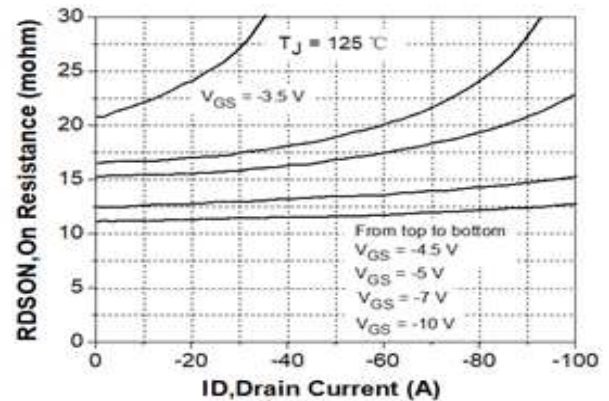

Fig.9 Typical Capacitance vs. Drain Source Voltage

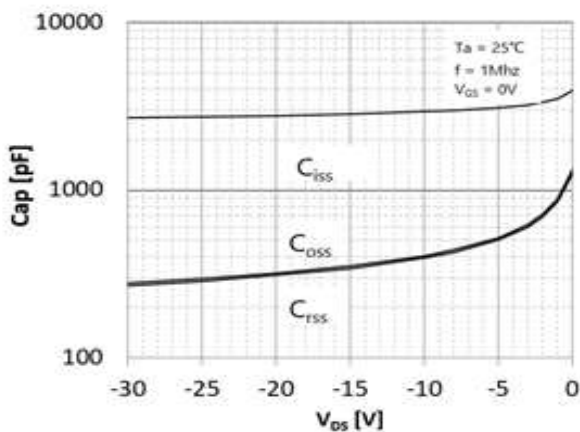

Fig.10 Dynamic Input Characteristics

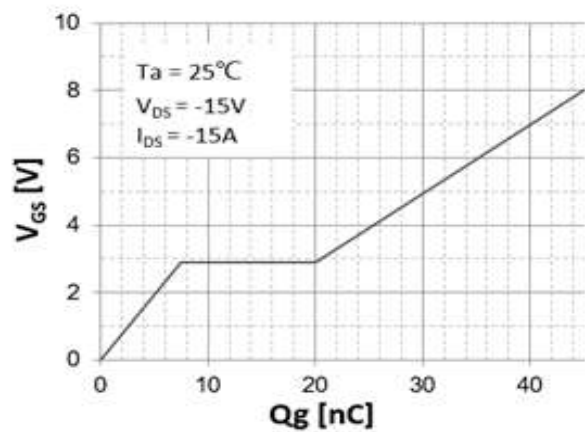

Fig.11 Breakdown Voltage vs. Junction Temperature

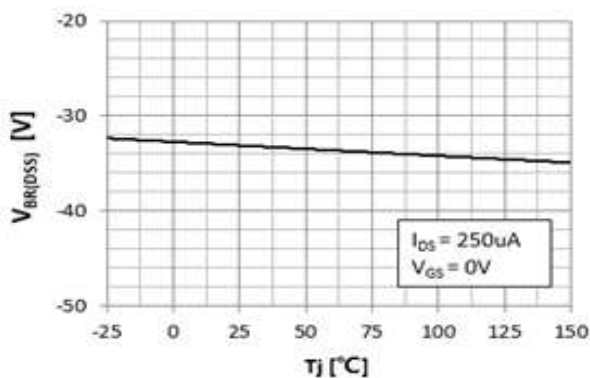

Fig. 12 Gate Threshold Voltage vs. Junction Temperature

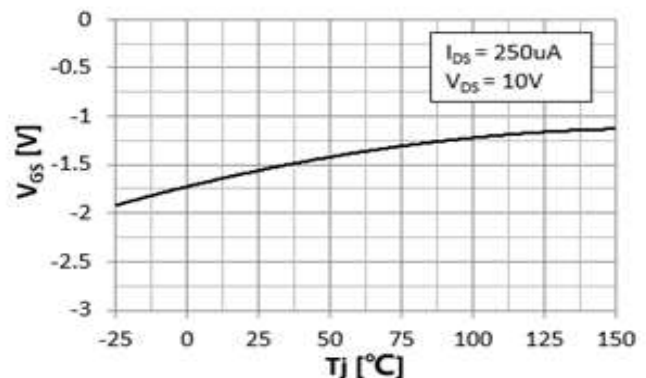

Fig.13 On-Resistance Variation vs. Junction Temperature

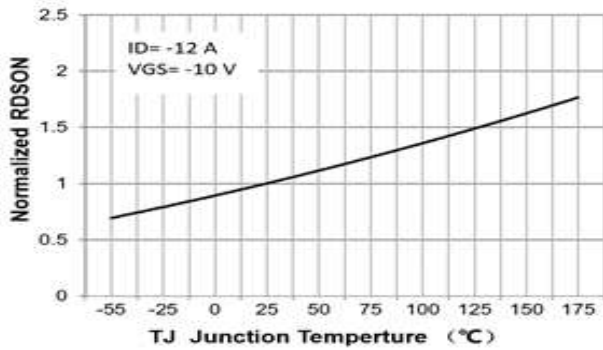

Fig.14 Maximum Drain Current vs. Case Temperature

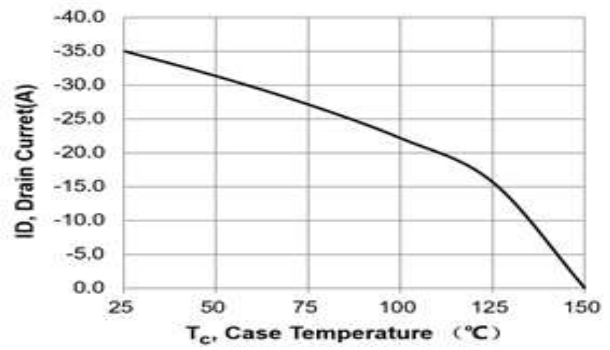

Fig.15 Body Diode Forward Voltage Vs Reverse Drain Current

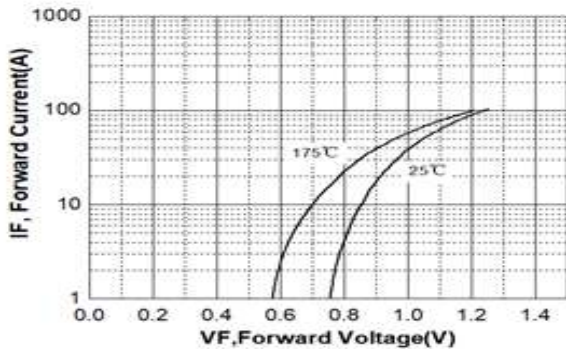

Fig.16 Safe Operating Area

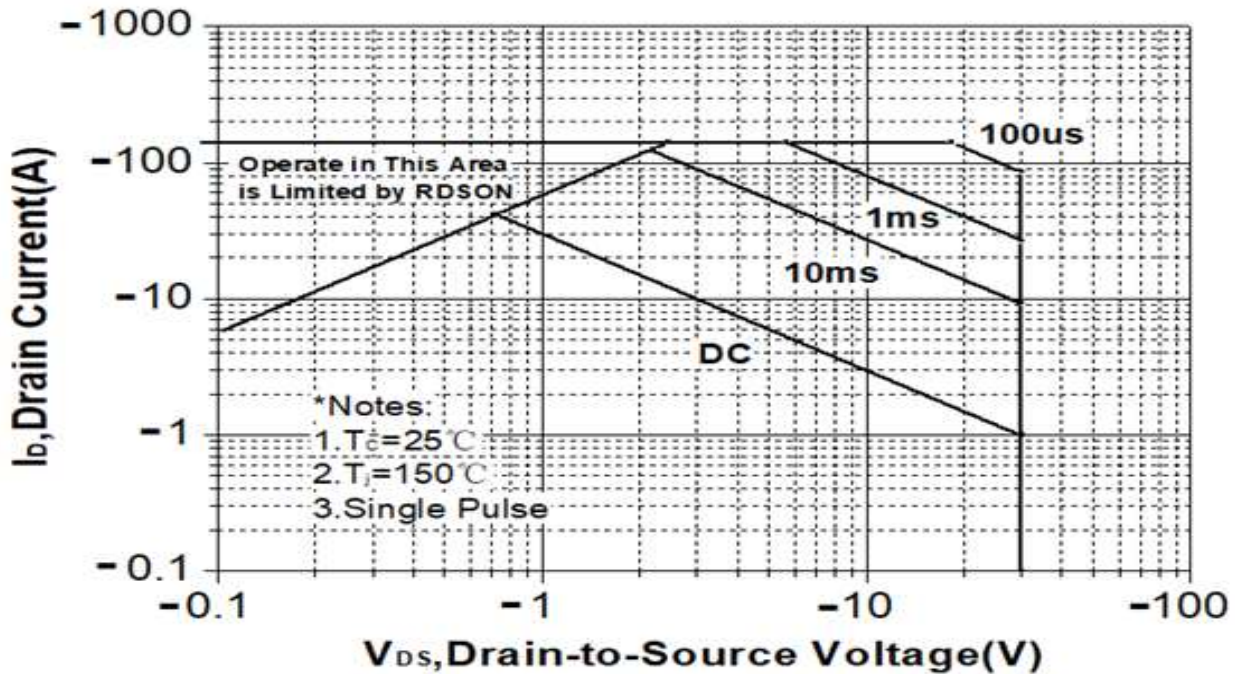
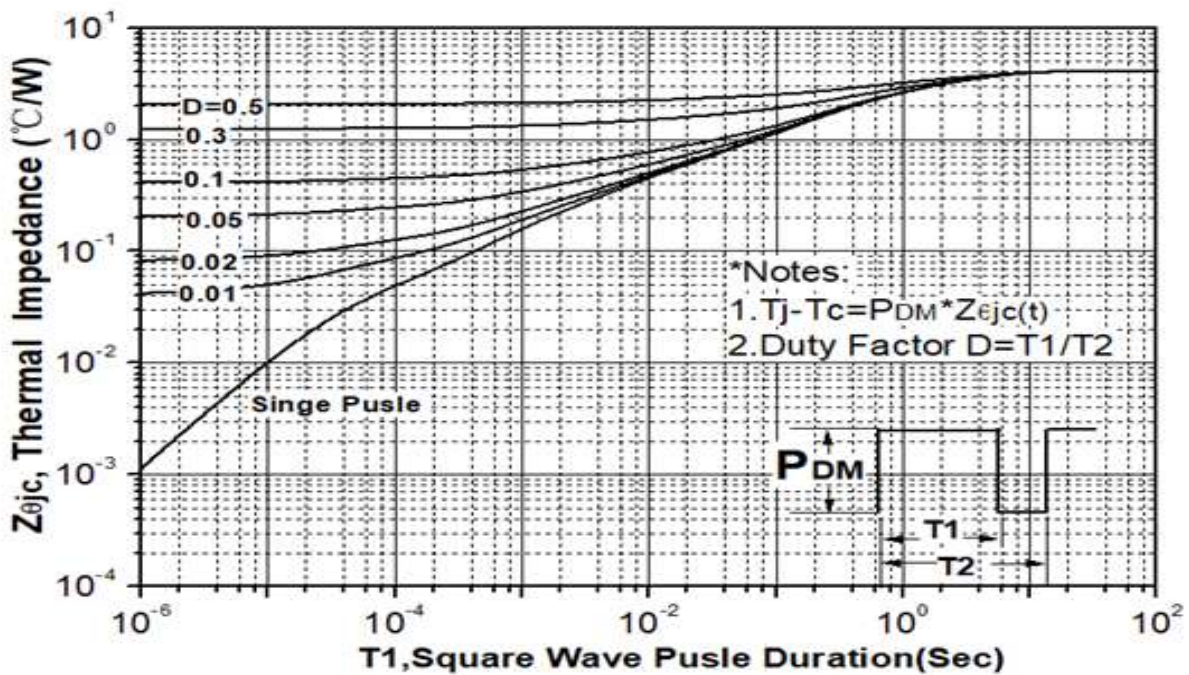
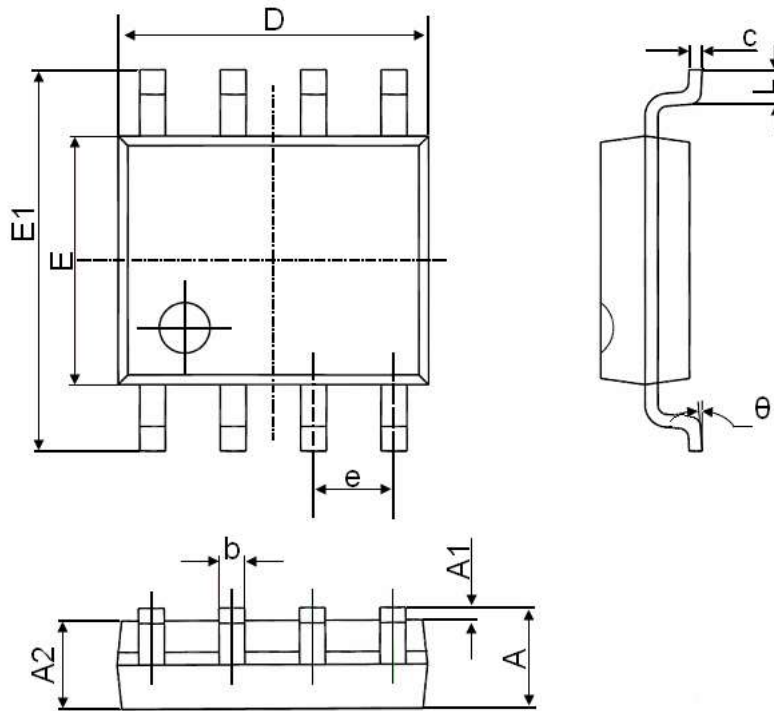

Fig. 17 Transient Thermal Response Curve



SOP-8 Package Information



Symbol	Dimensions In Millimeters		Dimensions In Inches	
	Min.	Max.	Min.	Max.
A	1.350	1.750	0.053	0.069
A1	0.100	0.250	0.004	0.010
A2	1.350	1.550	0.053	0.061
b	0.330	0.510	0.013	0.020
c	0.170	0.250	0.006	0.010
D	4.700	5.100	0.185	0.200
E	3.800	4.000	0.150	0.157
E1	5.800	6.200	0.228	0.244
e	1.270(BSC)		0.050(BSC)	
L	0.400	1.270	0.016	0.050
θ	0°	8°	0°	8°