

GENERAL DESCRIPTION

The SGM2203 is a high voltage, high accuracy and high PSRR linear regulator. It is capable of supplying 150mA output current. The operating input voltage is up to 36V. The output voltage range is from 2.5V to 12V in fixed output version.

Other features include current limit and thermal shutdown protection.

The SGM2203 is suitable for application which needs high PSRR and high voltage, such as palmtops high-power boost applications, etc.

The SGM2203 is available in Green SOT-23, SOT-23-5 and SOT-89-3 packages. It operates over an operating temperature range of -40°C to +85°C.

FEATURES

- **High Input Voltage: Up to 36V**
- **Fixed Output Voltages: 2.5V, 2.8V, 3.0V, 3.3V, 3.5V, 3.6V, 4.0V, 4.2V, 5.0V, 5.75V, 8.0V, 9.0V and 12V**
- **150mA Guaranteed Output Current**
- **Output Voltage Accuracy: ±3% at +25°C**
- **High PSRR: 40dB (TYP) at 1kHz**
- **Low Dropout Voltage**
- **Low Power Consumption: 4.2µA (TYP)**
- **Low Temperature Coefficient**
- **Thermal Shutdown Protection**
- **Output Current Limit**
- **-40°C to +85°C Operating Temperature Range**
- **Available in Green SOT-23, SOT-23-5 and SOT-89-3 Packages**

APPLICATIONS

- Palmtops
- High-Power Boost Applications
- Power Source for Battery-Powered Equipment
- Home Electric/Electronic Appliances

TYPICAL APPLICATION

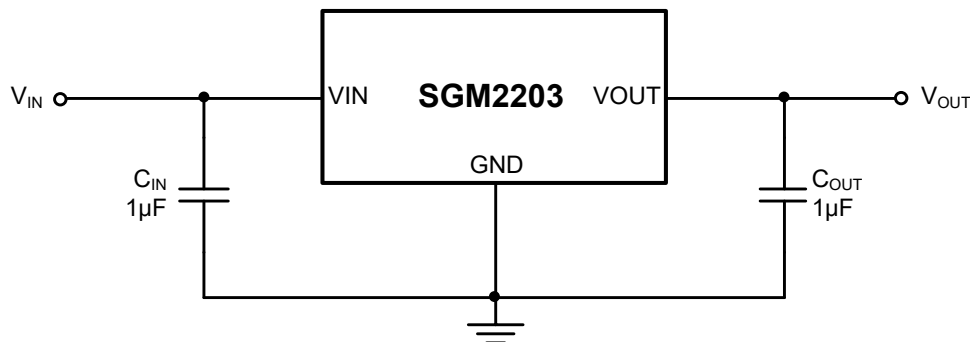

Figure 1. Typical Application Circuit

PACKAGE/ORDERING INFORMATION

MODEL	V _{OUT} (V)	PACKAGE DESCRIPTION	SPECIFIED TEMPERATURE RANGE	ORDERING NUMBER	PACKAGE MARKING	PACKING OPTION
SGM2203-2.5	2.5	SOT-23	-40°C to +85°C	SGM2203-2.5YN3LG/TR	SW6XX	Tape and Reel, 3000
SGM2203-2.8	2.8	SOT-23	-40°C to +85°C	SGM2203-2.8YN3LG/TR	SW7XX	Tape and Reel, 3000
SGM2203-3.0	3.0	SOT-23	-40°C to +85°C	SGM2203-3.0YN3LG/TR	SW8XX	Tape and Reel, 3000
SGM2203-3.3	3.3	SOT-23	-40°C to +85°C	SGM2203-3.3YN3LG/TR	SW9XX	Tape and Reel, 3000
SGM2203-3.6	3.6	SOT-23	-40°C to +85°C	SGM2203-3.6YN3LG/TR	SWAXX	Tape and Reel, 3000
SGM2203-5.0	5.0	SOT-23	-40°C to +85°C	SGM2203-5.0YN3LG/TR	SWBXX	Tape and Reel, 3000
SGM2203-2.5	2.5	SOT-89-3	-40°C to +85°C	SGM2203-2.5YK3G/TR	SWCXX	Tape and Reel, 1000
SGM2203-3.3	3.3	SOT-89-3	-40°C to +85°C	SGM2203-3.3YK3G/TR	SWDXX	Tape and Reel, 1000
SGM2203-3.6	3.6	SOT-89-3	-40°C to +85°C	SGM2203-3.6YK3G/TR	SWFXX	Tape and Reel, 1000
SGM2203-4.0	4.0	SOT-89-3	-40°C to +85°C	SGM2203-4.0YK3G/TR	CG2XX	Tape and Reel, 1000
SGM2203-4.2	4.2	SOT-89-3	-40°C to +85°C	SGM2203-4.2YK3G/TR	RD5XX	Tape and Reel, 1000
SGM2203-5.0	5.0	SOT-89-3	-40°C to +85°C	SGM2203-5.0YK3G/TR	SWEXX	Tape and Reel, 1000
SGM2203-5.75	5.75	SOT-89-3	-40°C to +85°C	SGM2203-5.75YK3G/TR	CG3XX	Tape and Reel, 1000
SGM2203-8.0	8.0	SOT-89-3	-40°C to +85°C	SGM2203-8.0YK3G/TR	G74XX	Tape and Reel, 1000
SGM2203-12	12	SOT-89-3	-40°C to +85°C	SGM2203-12YK3G/TR	G3FXX	Tape and Reel, 1000
SGM2203-3.0	3.0	SOT-89-3 (L-Type)	-40°C to +85°C	SGM2203-3.0YK3LG/TR	SX0XX	Tape and Reel, 1000
SGM2203-3.3	3.3	SOT-89-3 (L-Type)	-40°C to +85°C	SGM2203-3.3YK3LG/TR	G75XX	Tape and Reel, 1000
SGM2203-3.5	3.5	SOT-89-3 (L-Type)	-40°C to +85°C	SGM2203-3.5YK3LG/TR	G7EXX	Tape and Reel, 1000
SGM2203-4.0	4.0	SOT-89-3 (L-Type)	-40°C to +85°C	SGM2203-4.0YK3LG/TR	GF3XX	Tape and Reel, 1000
SGM2203-5.0	5.0	SOT-89-3 (L-Type)	-40°C to +85°C	SGM2203-5.0YK3LG/TR	SX1XX	Tape and Reel, 1000
SGM2203-8.0	8.0	SOT-89-3 (L-Type)	-40°C to +85°C	SGM2203-8.0YK3LG/TR	SX2XX	Tape and Reel, 1000
SGM2203-9.0	9.0	SOT-89-3 (L-Type)	-40°C to +85°C	SGM2203-9.0YK3LG/TR	SX3XX	Tape and Reel, 1000
SGM2203-12	12	SOT-89-3 (L-Type)	-40°C to +85°C	SGM2203-12YK3LG/TR	G40XX	Tape and Reel, 1000
SGM2203-3.0	3.0	SOT-23-5	-40°C to +85°C	SGM2203-3.0YN5G/TR	GDFXX	Tape and Reel, 3000
SGM2203-3.3	3.3	SOT-23-5	-40°C to +85°C	SGM2203-3.3YN5G/TR	GE0XX	Tape and Reel, 3000
SGM2203-5.0	5.0	SOT-23-5	-40°C to +85°C	SGM2203-5.0YN5G/TR	GJ9XX	Tape and Reel, 3000
SGM2203-4.2	4.2	SOT-23-5 (L-Type)	-40°C to +85°C	SGM2203-4.2YN5LG/TR	GN9XX	Tape and Reel, 3000

MARKING INFORMATION

NOTE: XX = Date Code.

YYY X X

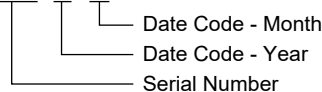

Green (RoHS & HSF): SG Micro Corp defines "Green" to mean Pb-Free (RoHS compatible) and free of halogen substances. If you have additional comments or questions, please contact your SGMICRO representative directly.

ABSOLUTE MAXIMUM RATINGS

VIN to GND	-0.3V to 44V
VOUT to GND, $V_{OUT} \leq 5.0V$	-0.3V to $\text{Min}(V_{IN} + 0.3V, 6V)$
VOUT to GND, $V_{OUT} > 5.0V$	-0.3V to $\text{Min}(V_{IN} + 0.3V, 15V)$
Power Dissipation, P_D @ $T_A = +25^\circ\text{C}$	
SOT-23	0.411W
SOT-23-5	0.411W
SOT-23-5 (L-Type).....	0.517W
SOT-89-3	1.923W
SOT-89-3 (L-Type).....	0.822W
Package Thermal Resistance	
SOT-23, θ_{JA}	304°C/W
SOT-23-5, θ_{JA}	304°C/W
SOT-23-5 (L-Type), θ_{JA}	242°C/W
SOT-89-3, θ_{JA}	65°C/W
SOT-89-3 (L-Type), θ_{JA}	152°C/W
Junction Temperature	+150°C
Storage Temperature Range.....	-65°C to +150°C
Lead Temperature (Soldering, 10s)	+260°C
ESD Susceptibility	
HBM.....	4000V
MM.....	200V
CDM	1000V

RECOMMENDED OPERATING CONDITIONS

Input Voltage Range	2.7V to 36V
Operating Temperature Range	-40°C to +85°C

OVERSTRESS CAUTION

Stresses beyond those listed in Absolute Maximum Ratings may cause permanent damage to the device. Exposure to absolute maximum rating conditions for extended periods may affect reliability. Functional operation of the device at any conditions beyond those indicated in the Recommended Operating Conditions section is not implied.

ESD SENSITIVITY CAUTION

This integrated circuit can be damaged if ESD protections are not considered carefully. SGMICRO recommends that all integrated circuits be handled with appropriate precautions. Failure to observe proper handling and installation procedures can cause damage. ESD damage can range from subtle performance degradation to complete device failure. Precision integrated circuits may be more susceptible to damage because even small parametric changes could cause the device not to meet the published specifications.

DISCLAIMER

SG Micro Corp reserves the right to make any change in circuit design, or specifications without prior notice.

PIN CONFIGURATIONS

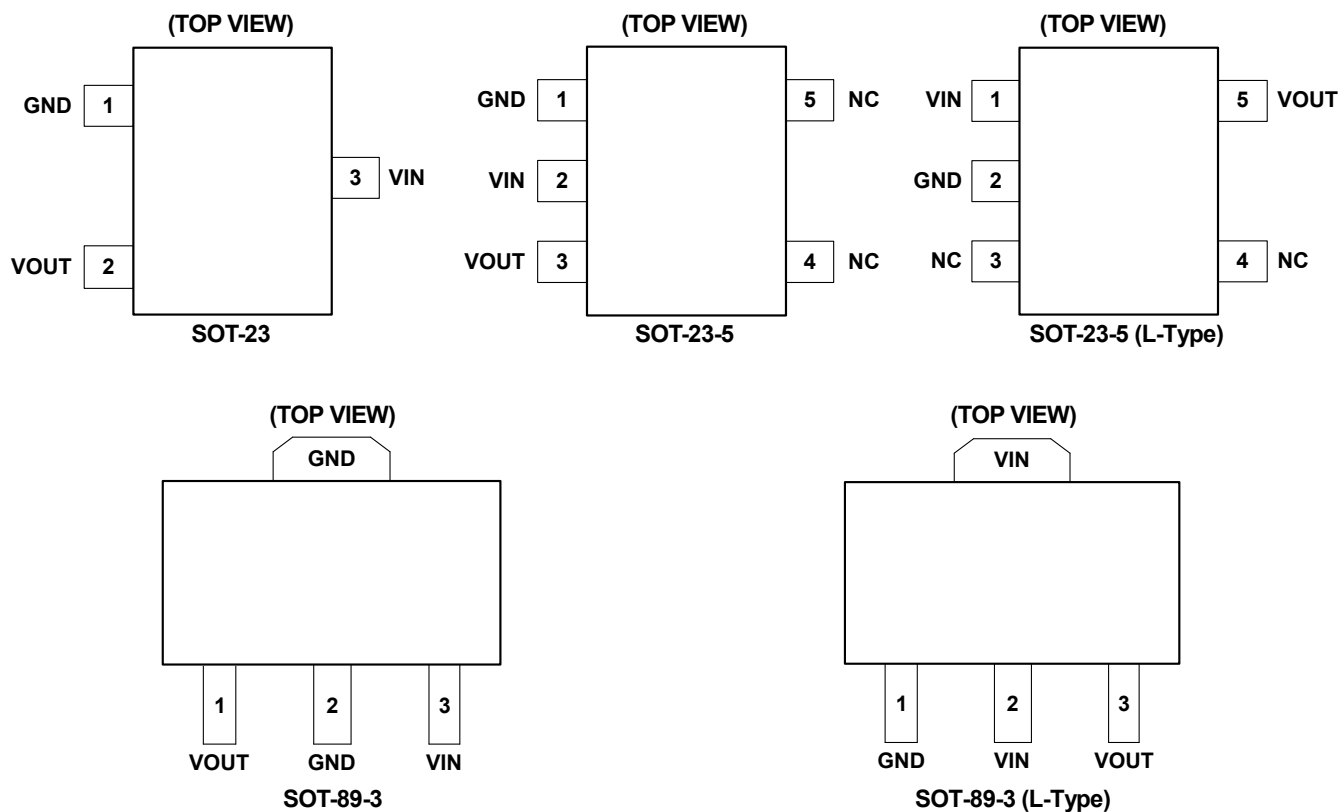

PIN DESCRIPTION

PIN					NAME	FUNCTION
SOT-23	SOT-23-5	SOT-23-5 (L-Type)	SOT-89-3	SOT-89-3 (L-Type)		
1	1	2	2	1	GND	Ground.
2	3	5	1	3	VOUT	Regulator Output Pin. It is recommended to use an output capacitor with effective capacitance in the range of 1μF to 10μF. The capacitor should be located very close to this pin.
3	2	1	3	2	VIN	Regulator Input Pin. Up to 36V input voltage. It is recommended to use a 1μF or larger ceramic capacitor from VIN pin to ground.
–	4, 5	3, 4	–	–	NC	Not Connected.

ELECTRICAL CHARACTERISTICS

($V_{IN} = V_{OUT} + 2V$ or $4V$, whichever is greater, $C_{IN} = C_{OUT} = 1\mu F$, Full = $-40^{\circ}C$ to $+85^{\circ}C$, typical values are at $T_A = +25^{\circ}C$, unless otherwise noted.)

PARAMETER	SYMBOL	CONDITIONS	TEMP	MIN	TYP	MAX	UNITS	
Input Voltage	V_{IN}	$V_{OUT} < 3.3V$	Full	2.7		32	V	
		$V_{OUT} \geq 3.3V$	Full	2.7		36		
Output Voltage Accuracy	V_{OUT}	$I_{OUT} = 1mA$	$+25^{\circ}C$	-3		3	%	
Ground Pin Current		No load	$+25^{\circ}C$		4.2	5.5	μA	
			Full			6.5		
		$I_{OUT} = 50mA$	$+25^{\circ}C$		4.2			
Maximum Output Current ⁽¹⁾			$+25^{\circ}C$	150			mA	
Dropout Voltage ⁽²⁾	V_{DROP}	$I_{OUT} = 150mA, V_{OUT} \geq 2.5V$	$+25^{\circ}C$		1300	1850	mV	
			Full			2400		
Line Regulation	$\frac{\Delta V_{OUT}}{\Delta V_{IN} \times V_{OUT}}$	$V_{IN} = V_{OUT} + 2V$ or $4V$ to $32V$, $I_{OUT} = 1mA$	$V_{OUT} < 3.3V$	$+25^{\circ}C$		0.005	0.012	%V
		$V_{IN} = V_{OUT} + 2V$ to $36V$, $I_{OUT} = 1mA$	$V_{OUT} \geq 3.3V$	$+25^{\circ}C$		0.005	0.012	
Load Regulation	ΔV_{OUT}	$V_{IN} = V_{OUT} + 2V$ or $4V, I_{OUT} = 1mA$ to $150mA$	$+25^{\circ}C$		10	25	mV	
Power Supply Rejection Ratio	PSRR	$V_{OUT} = 3.3V, I_{OUT} = 10mA$	$f = 217Hz$	$+25^{\circ}C$		55	dB	
			$f = 1kHz$	$+25^{\circ}C$		40		
Output Voltage Temperature Coefficient ⁽³⁾	$\frac{\Delta V_{OUT}}{\Delta T_A \times V_{OUT}}$	$I_{OUT} = 1mA$	Full		68		ppm/ $^{\circ}C$	
Thermal Protection								
Thermal Shutdown Temperature	T_{SHDN}				150		$^{\circ}C$	
Thermal Shutdown Hysteresis	ΔT_{SHDN}				20		$^{\circ}C$	

NOTES:

1. Maximum output current is affected by the PCB layout, size of metal trace, the thermal conduction path between metal layers, ambient temperature and the other environment factors of system. Attention should be paid to the dropout voltage when $V_{IN} < V_{OUT} + V_{DROP}$.
2. The dropout voltage is defined as $V_{IN} - V_{OUT}$, when V_{OUT} is 95% of the value of V_{OUT} for $V_{IN} = V_{OUT} + 2V$.
3. Output voltage temperature coefficient is defined as the worst-case voltage change divided by the total temperature range.

TYPICAL PERFORMANCE CHARACTERISTICS

$T_A = +25^\circ\text{C}$, $V_{IN} = 5.3\text{V}$, $V_{OUT} = 3.3\text{V}$, $C_{IN} = C_{OUT} = 1\mu\text{F}$, unless otherwise noted.

Load-Transient Response

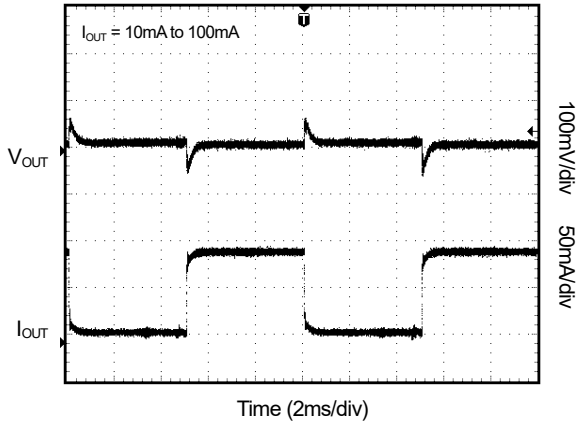

Line-Transient Response

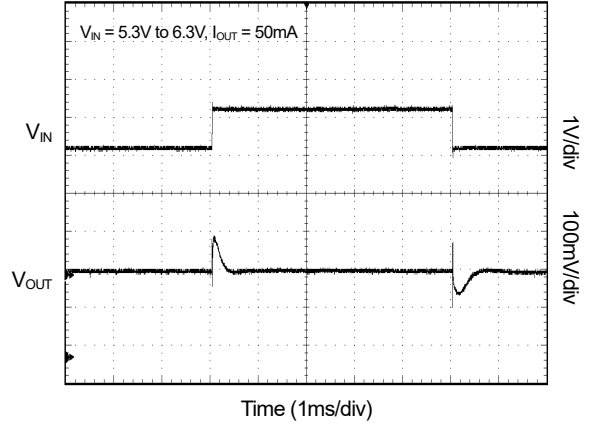

Power-Up/Power-Down Output Waveform

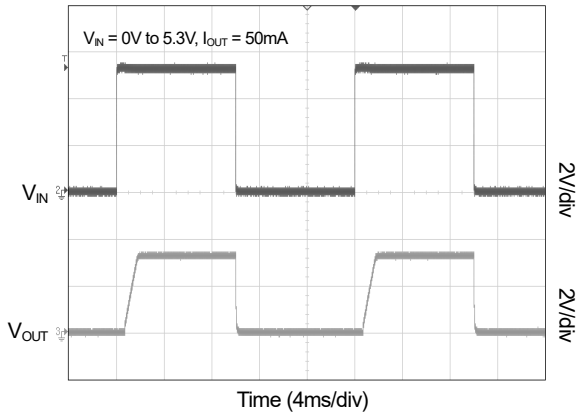

Power Ramp-Up/Ramp-Down Output Waveform

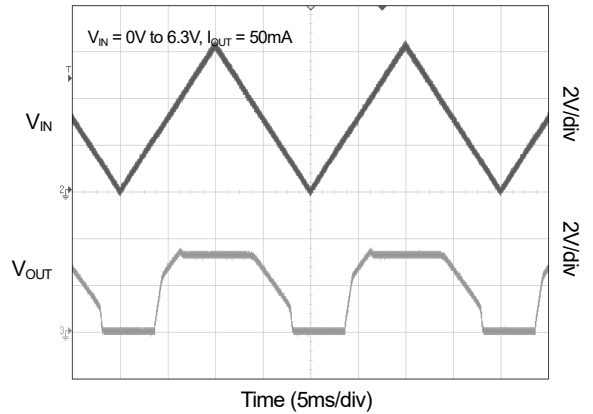

Output Short Waveform

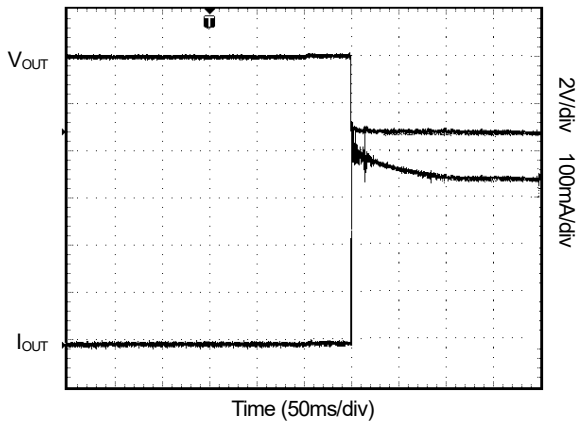

Thermal Protection Waveform

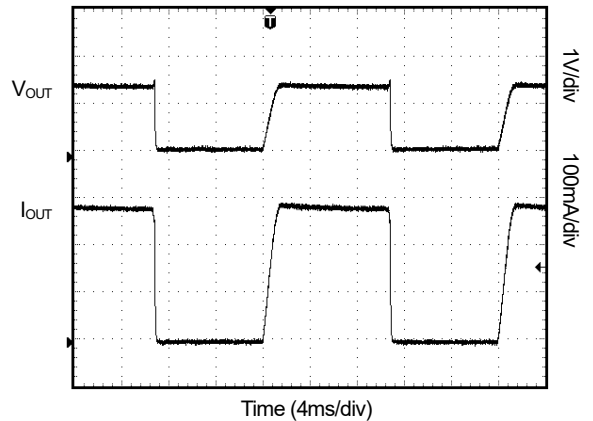

TYPICAL PERFORMANCE CHARACTERISTICS (continued)

T_A = +25°C, V_{IN} = 5.3V, V_{OUT} = 3.3V, C_{IN} = C_{OUT} = 1μF, unless otherwise noted.

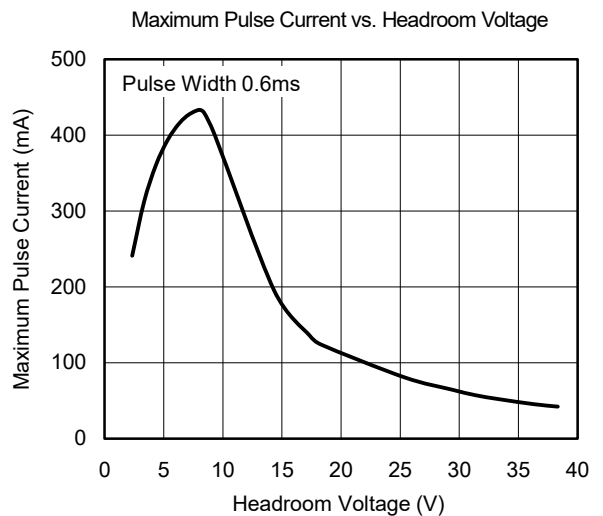
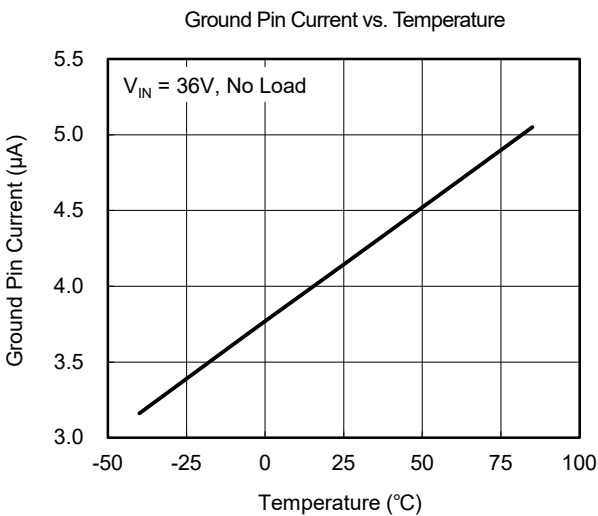
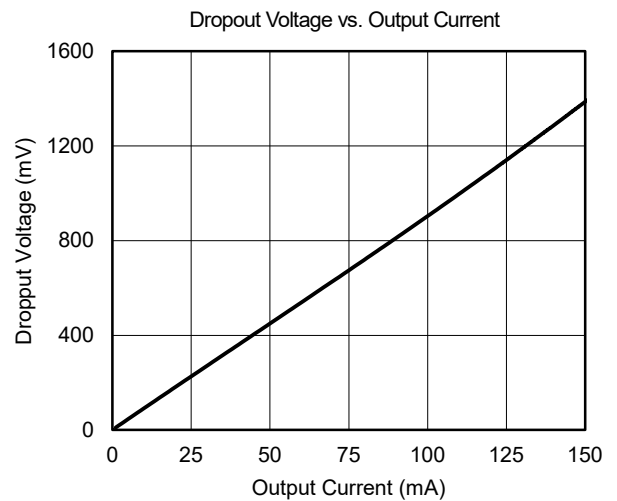
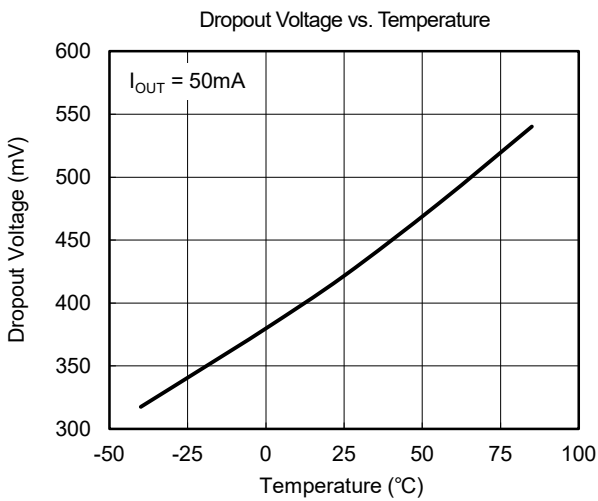
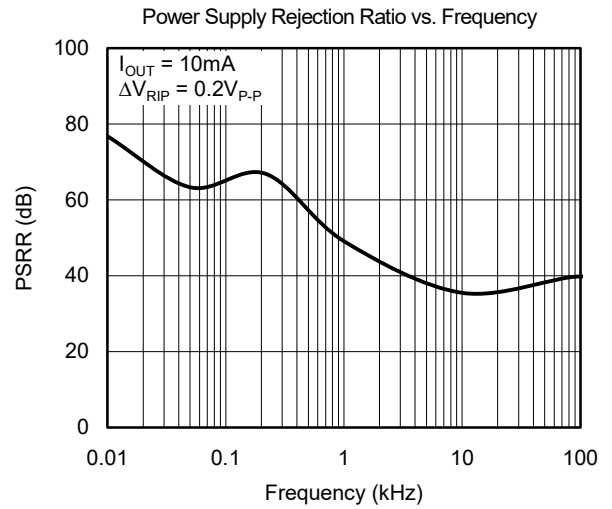
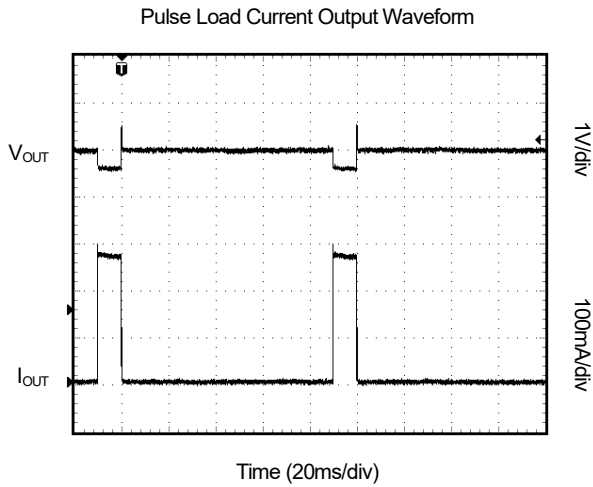

REVISION HISTORY

NOTE: Page numbers for previous revisions may differ from page numbers in the current version.

	Page
OCTOBER 2020 – REV.A.3 to REV.A.4	
Updated Package/Ordering Information section	2
FEBRUARY 2020 – REV.A.2 to REV.A.3	Page
Updated Marking Information	3
MAY 2019 – REV.A.1 to REV.A.2	Page
Added SGM2203-4.0YK3G/TR and SGM2203-5.75YK3G/TR versions	All
AUGUST 2017 – REV.A to REV.A.1	Page
Added SOT-23-5 package.....	2-4
Changes from Original (JUNE 2017) to REV.A	Page
Changed from product preview to production data	All

PACKAGE OUTLINE DIMENSIONS

SOT-23

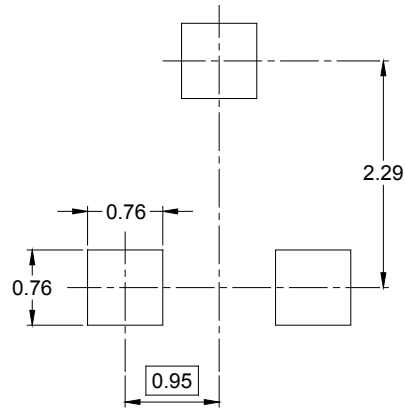
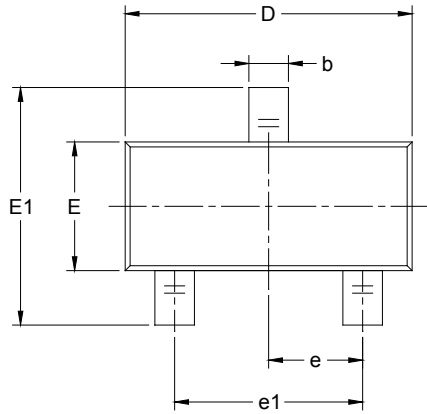

RECOMMENDED LAND PATTERN (Unit: mm)

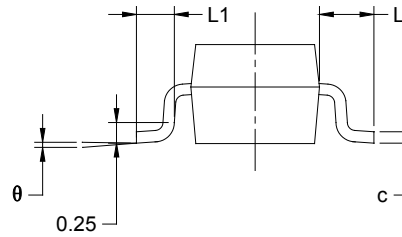
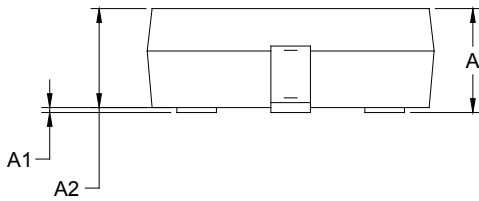

Symbol	Dimensions In Millimeters		Dimensions In Inches	
	MIN	MAX	MIN	MAX
A	0.900	1.150	0.035	0.045
A1	0.000	0.100	0.000	0.004
A2	0.900	1.050	0.035	0.041
b	0.300	0.500	0.012	0.020
c	0.080	0.150	0.003	0.006
D	2.800	3.000	0.110	0.118
E	1.200	1.400	0.047	0.055
E1	2.250	2.550	0.089	0.100
e	0.950 BSC		0.037 BSC	
e1	1.900 BSC		0.075 BSC	
L	0.550 REF		0.022 REF	
L1	0.300	0.500	0.012	0.020
θ	0°	8°	0°	8°

PACKAGE OUTLINE DIMENSIONS

SOT-23-5

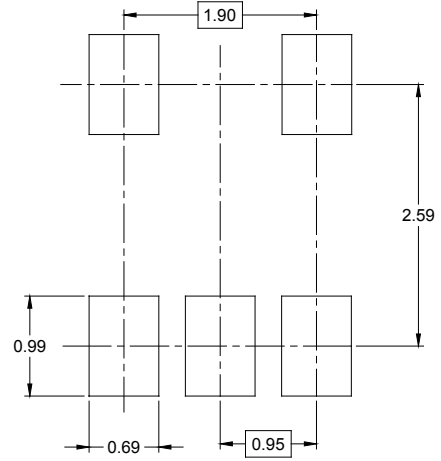

RECOMMENDED LAND PATTERN (Unit: mm)



Symbol	Dimensions In Millimeters		Dimensions In Inches	
	MIN	MAX	MIN	MAX
A	1.050	1.250	0.041	0.049
A1	0.000	0.100	0.000	0.004
A2	1.050	1.150	0.041	0.045
b	0.300	0.500	0.012	0.020
c	0.100	0.200	0.004	0.008
D	2.820	3.020	0.111	0.119
E	1.500	1.700	0.059	0.067
E1	2.650	2.950	0.104	0.116
e	0.950 BSC		0.037 BSC	
e1	1.900 BSC		0.075 BSC	
L	0.300	0.600	0.012	0.024
θ	0°	8°	0°	8°

PACKAGE OUTLINE DIMENSIONS

SOT-89-3

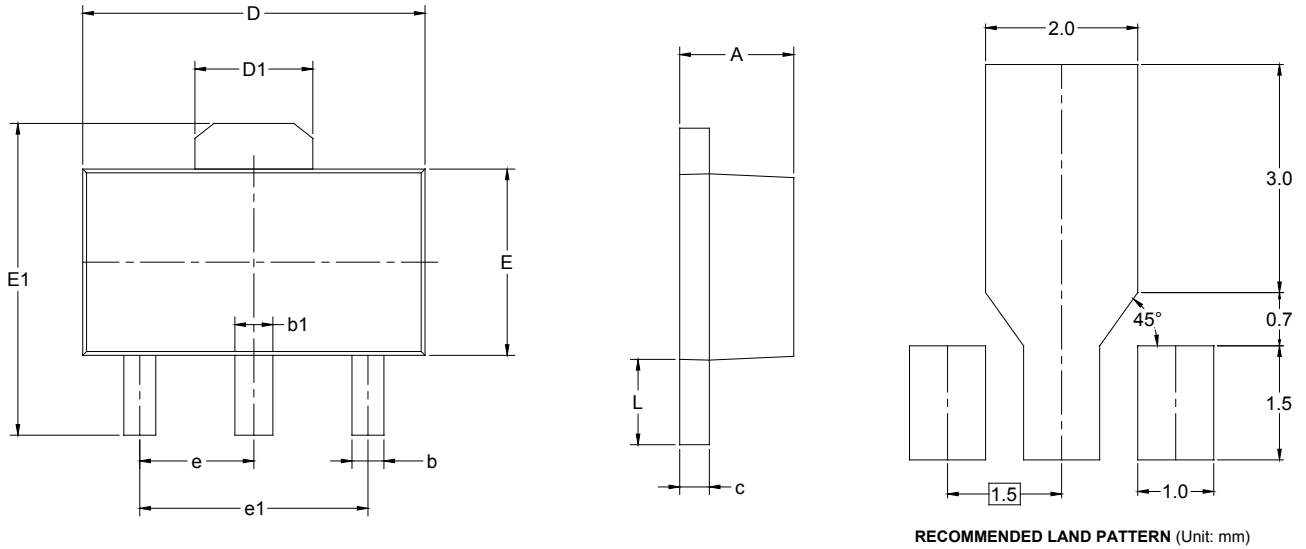

Symbol	Dimensions In Millimeters		Dimensions In Inches	
	MIN	MAX	MIN	MAX
A	1.400	1.600	0.055	0.063
b	0.320	0.520	0.013	0.020
b1	0.400	0.580	0.016	0.023
c	0.350	0.440	0.014	0.017
D	4.400	4.600	0.173	0.181
D1	1.550 REF		0.061 REF	
E	2.300	2.600	0.091	0.102
E1	3.940	4.250	0.155	0.167
e	1.500 TYP		0.060 TYP	
e1	3.000 TYP		0.118 TYP	
L	0.900	1.200	0.035	0.047

PACKAGE INFORMATION

TAPE AND REEL INFORMATION

REEL DIMENSIONS



TAPE DIMENSIONS



NOTE: The picture is only for reference. Please make the object as the standard.

KEY PARAMETER LIST OF TAPE AND REEL

Package Type	Reel Diameter	Reel Width W1 (mm)	A0 (mm)	B0 (mm)	K0 (mm)	P0 (mm)	P1 (mm)	P2 (mm)	W (mm)	Pin1 Quadrant
SOT-23	7"	9.5	3.15	2.77	1.22	4.0	4.0	2.0	8.0	Q3
SOT-23-5	7"	9.5	3.20	3.20	1.40	4.0	4.0	2.0	8.0	Q3
SOT-89-3	7"	13.2	4.85	4.45	1.85	4.0	8.0	2.0	12.0	Q3

DD0001

PACKAGE INFORMATION

CARTON BOX DIMENSIONS



NOTE: The picture is only for reference. Please make the object as the standard.

KEY PARAMETER LIST OF CARTON BOX

Reel Type	Length (mm)	Width (mm)	Height (mm)	Pizza/Carton
7" (Option)	368	227	224	8
7"	442	410	224	18

DD0002