

## PT05D5B – ESD Protection Diode

### Feature

- 400 Watts peak pulse power (8/20 $\mu$ s)
- Bidirectional configurations
- Solid state silicon-avalanche technology
- Low clamping voltage
- Low leakage current
- IEC61000-4-2 (ESD)  $\pm$ 30kV (Air),  $\pm$ 15kV (Contact)
- IEC61000-4-4 (EFT) 40A (5/50ns)
- IEC61000-4-5 (Lightning): 20A (8/20 $\mu$ s)



### Applications

- Microprocessor based equipment
- Notebooks, Desktops, and Servers
- Portable Instrumentation
- Personal Digital Assistant (PDA)
- Pagers Peripherals

### Mechanical Data

- SOD523 package
- Molding compound flammability rating: UL94 V-0
- Tape and Reel Packaging
- RoHS/WEEE Compliant

### Schematic and PIN Configuration

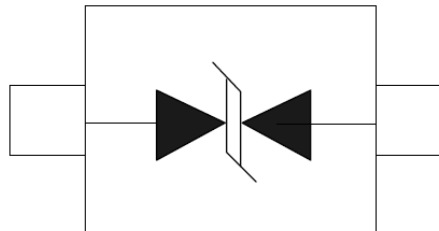

SOD-523

### Maximum Rating

Parameter	Symbol	Limit	Unit
IEC61000-4-2 ESD Voltage – Air Mode	$V_{ESD}^{(1)}$	$\pm$ 30	kV
IEC61000-4-2 ESD Voltage – Contact Mode		$\pm$ 15	
Peak Pulse Power	$P_{PP}^{(2)}$	400	W
Peak Pulse Current	$I_{PP}^{(2)}$	20	A
Maximum Lead Solder Temperature (10 seconds duration)	$T_L$	260	$^{\circ}$ C
Junction Temperature	$T_J$	-55~150	$^{\circ}$ C
Storage Temperature Range	$T_{stg}$	-55~150	$^{\circ}$ C

Note:

1. Device stressed with ten non-repetitive ESD pulses.
2. Non-repetitive current pulse 8/20 $\mu$ s exponential decay waveform according to IEC61000-4-5.
3. All ratings are measured at environmental temperature of  $T_A = 25^{\circ}$ C unless otherwise noted.

## PT05D5B – ESD Protection Diode

### Electrical Characteristics

Parameter	Symbol	Test Conditions	Min	Typ	Max	Unit
Reverse Stand-off Voltage	$V_{RWM}^{(1)}$				5.0	V
Reverse Breakdown Voltage	$V_{BR}$	$I_T = 1\text{mA}$	6.0			V
Reverse Leakage Current	$I_R$	$V_{RWM} = 5\text{V}$			1	$\mu\text{A}$
Clamping Voltage	$V_C^{(2)}$	$I_{PP} = 20\text{A}$			20	V
Junction Capacitance	$C_J$	$V_R = 0\text{V}, f = 1\text{MHz}$		35	40	pF

Note:

1. Other voltages available upon request.
2. Non-repetitive current pulse 8/20 $\mu\text{s}$  exponential decay waveform according to IEC61000-4-5.
3. All ratings are measured at environmental temperature of  $T_A = 25^\circ\text{C}$  unless otherwise noted.

### Electrical Parameters

Symbol	Parameter
$V_C$	Clamping Voltage @ $I_{PP}$
$I_{PP}$	Reverse Peak Pulse Current
$V_{BR}$	Breakdown Voltage @ $I_T$
$I_T$	Test Current
$I_R$	Reverse Leakage Current @ $V_{RWM}$
$V_{RWM}$	Working Peak Reverse Voltage

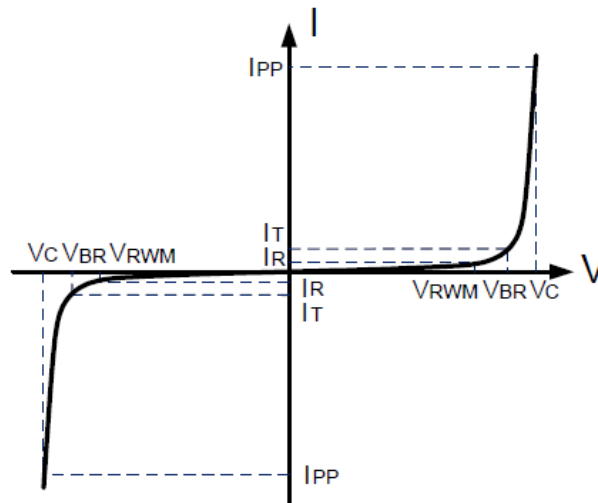

## PT05D5B – ESD Protection Diode

### Typical Characteristics

Figure 1: Peak Pulse Power vs. Pulse Time

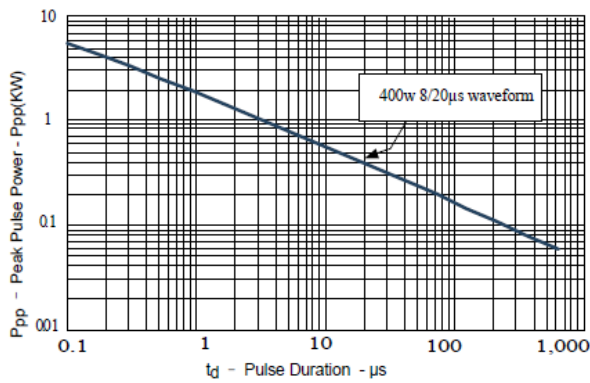

Figure 2: Power Derating Curve

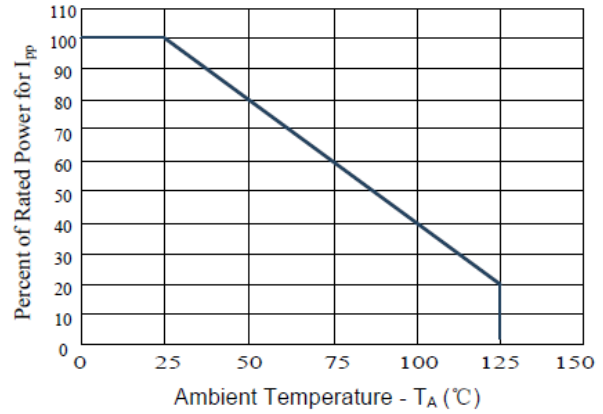

Figure3: Pulse Waveform

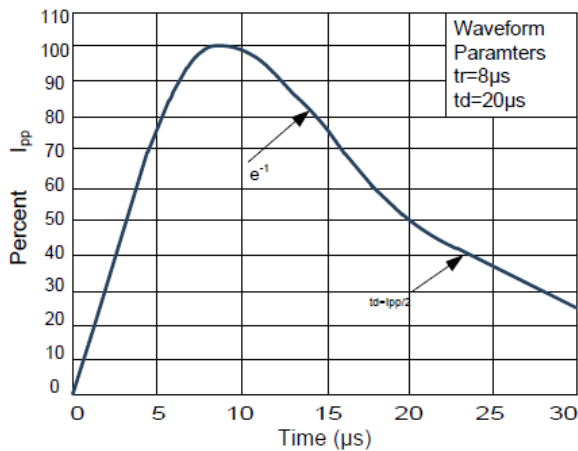
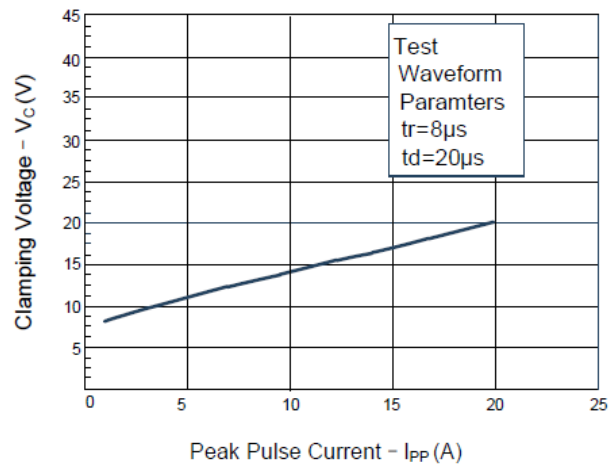
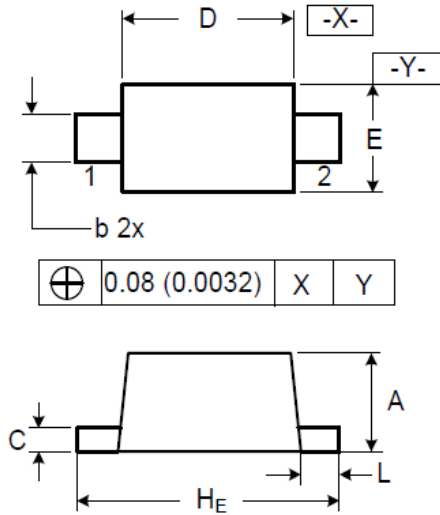

Figure 4: Clamping Voltage vs. Ipp



## PT05D5B – ESD Protection Diode

### SOD523 Package Outline Dimensions



Symbol	Dimensions (mm)		Dimensions (inch)	
	Min	Max	Min	Max
A	0.500	0.700	0.020	0.028
b	0.250	0.350	0.010	0.014
C	0.070	0.200	0.0028	0.0079
D	1.100	1.300	0.043	0.051
E	0.700	0.900	0.028	0.035
H <sub>E</sub>	1.500	1.700	0.059	0.067
L	0.150	0.250	0.006	0.010

### Marking

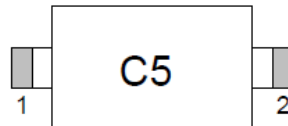

### Packaging Information

Order Code	Packaging	Reel Size	PCS/Reel
PT05D5B	SOD523	7 inch	5,000