



UP3855

PNP SILICON TRANSISTOR

PNP MEDIUM POWER LOW SATURATION TRANSISTOR

DESCRIPTION

The UTC **UP3855** is a transistor with low saturation voltage. It provides customers with very low on-state losses that makes it ideal for applications, such as driving and power management functions and DC-DC circuits.

FEATURES

- * Extremely low saturation voltages
- * Peak current up to 10A
- * 4A continuous current

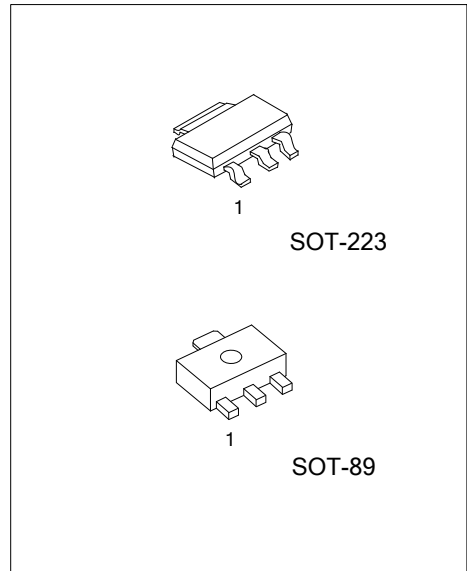

ORDERING INFORMATION

Ordering Number	Package	Pin Assignment			Packing
		1	2	3	
UP3855G-AA3-R	SOT-223	B	C	E	Tape Reel
UP3855G-AB3-R	SOT-89	B	C	E	Tape Reel

Note: Pin Assignment: B: Base C: Collector E: Emitter

<p>UP3855G-AA3-R</p> <p>(1) Packing Type (2) Package Type (3) Green Package</p>	<p>(1) R: Tape Reel (2) AA3: SOT-223, AB3: SOT-89 (3) G: Halogen Free and Lead Free</p>
---	---

MARKING

SOT-89	SOT-223

■ ABSOLUTE MAXIMUM RATING (T_A=25°C, unless otherwise specified)

PARAMETER		SYMBOL	RATINGS	UNIT
Collector-Base Voltage		V _{CBO}	-180	V
Collector-Emitter Voltage		V _{CEO}	-140	V
Emitter-Base Voltage		V _{EBO}	-7	V
Continuous Collector Current (Note 1)		I _C	-4	A
Peak Pulse Current		I _{CM}	-10	A
Power Dissipation	SOT-223	P _D	3.0 (Note 1)	W
			1.6 (Note 2)	
	SOT-89		0.6	
Junction Temperature		T _J	+150	°C
Storage Temperature		T _{STG}	-55 ~ +150	°C

Note: Absolute maximum ratings are those values beyond which the device could be permanently damaged. Absolute maximum ratings are stress ratings only and functional device operation is not implied.

■ THERMAL RESISTANCE

PARAMETER		SYMBOL	RATINGS	UNIT
Junction to Ambient	SOT-223	θ _{JA}	42 (Note 1)	°C/W
			78 (Note 2)	
	SOT-89		208	

Notes: 1. For a device surface mounted on 52mm x 52mm x 1.6mm FR4 PCB with high coverage of single sided 2oz copper, in still air conditions.

2. For a device surface mounted on 25mm x 25mm x 1.6mm FR4 PCB with high coverage of single sided 1oz copper, in still air conditions.

■ ELECTRICAL CHARACTERISTICS (T_A = 25°C unless otherwise stated)

PARAMETER	SYMBOL	TEST CONDITIONS	MIN	TYP	MAX	UNIT
Collector-Base Breakdown Voltage	V _{CBO}	I _C =-100μA	-180	-200		V
Collector-Emitter Breakdown Voltage	V _{CER}	I _C =-1μA, R _B ≤1kΩ	-180	-200		V
Collector-Emitter Breakdown Voltage	V _{CEO}	I _C =-10mA (Note 1)	-140	-160		V
Emitter-Base Breakdown Voltage	V _{EBO}	I _E =-100μA	-7.0	-8.0		V
Collector Cut-Off Current	I _{CBO}	V _{CB} =-150V		<1	-20	nA
		V _{CB} =-150V, T _A =100°C			-0.5	μA
Collector Cut-Off Current	I _{CER}	V _{CB} =-150V, R _≤ 1kΩ		<1	-20	nA
		T _A =100°C			-0.5	μA
Emitter Cut-Off Current	I _{EBO}	V _{EB} =-6V		<1	-10	nA
Collector-Emitter Saturation Voltage (Note 1)	V _{CE(SAT)}	I _C =-0.1A, I _B =-5mA		-40	-60	mV
		I _C =-0.5A, I _B =-50mA		-55	-80	mV
		I _C =-1A, I _B =-100mA		-85	-120	mV
		I _C =-3A, I _B =-300mA		-275	-360	mV
Base-Emitter Saturation Voltage	V _{BE(SAT)}	I _C =-3A, I _B =-300mA (Note 1)		-940	-1040	mV
Base-Emitter Turn-On Voltage	V _{BE(ON)}	I _C =-3A, V _{CE} =-5V (Note 1)		-830	-930	mV
Static Forward Current Transfer Ratio (Note 1)	h _{FE}	I _C =-10mA, V _{CE} =-5V	100	225		
		I _C =-1A, V _{CE} =-5V	100	200	300	
		I _C =-3A, V _{CE} =-5V	45	100		
		I _C =-10A, V _{CE} =-5V		5		
Transition Frequency	f _T	I _C =-100mA, V _{CE} =-10V f=50MHz		120		MHz
Output Capacitance (Note 1)	C _{OBO}	V _{CB} =-10V, f=1MHz		33		pF
Switching Times	t _{ON}	I _C =-1A, V _{CC} =-50V,		150		ns
	t _{OFF}	I _{B1} =-I _{B2} =-100mA		750		

Note: 1. Measured under pulsed conditions. Pulse width≤300μs; duty cycle≤2%.

TYPICAL CHARACTERISTICS

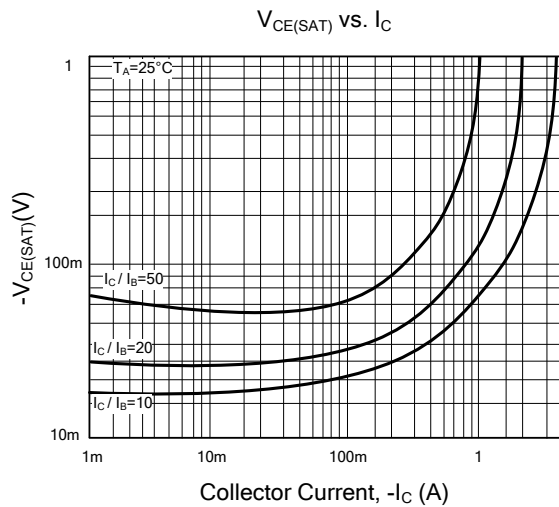
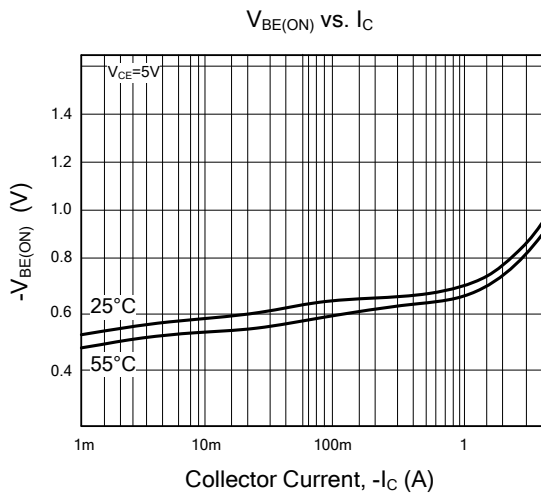
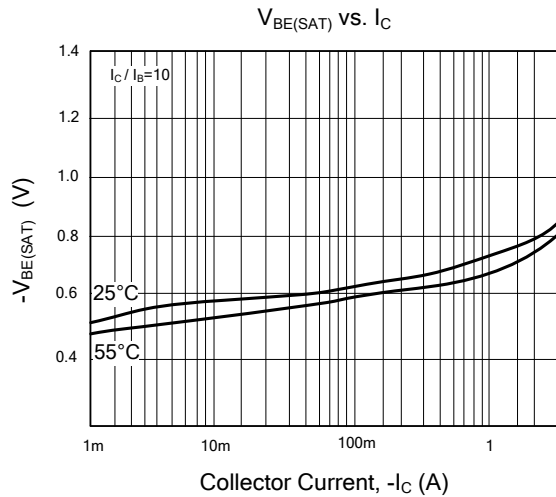
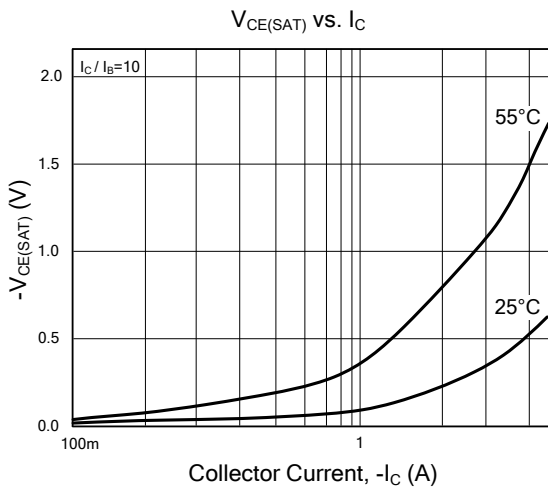
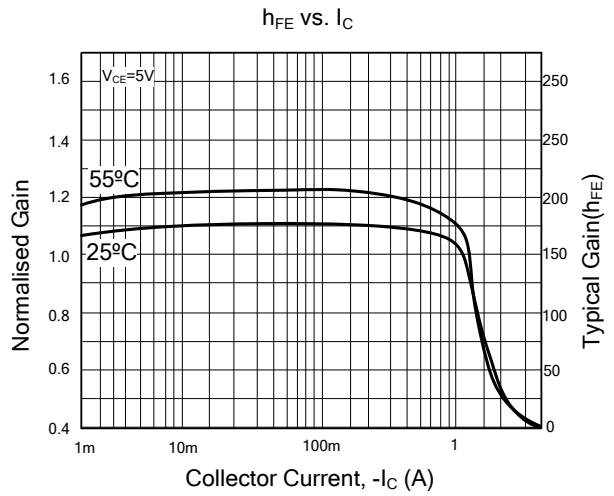
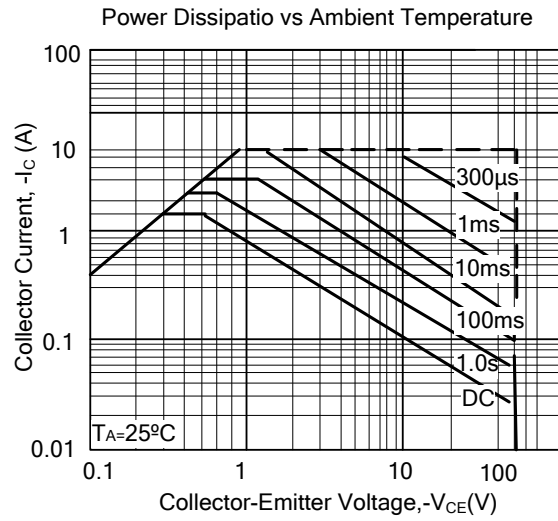

■ TYPICAL CHARACTERISTICS (Cont.)

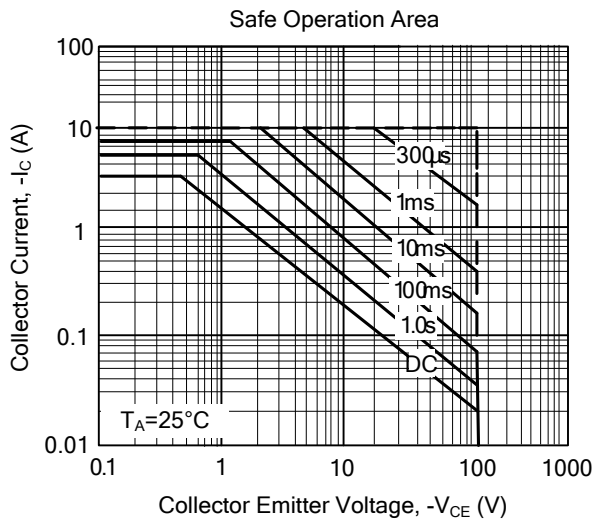
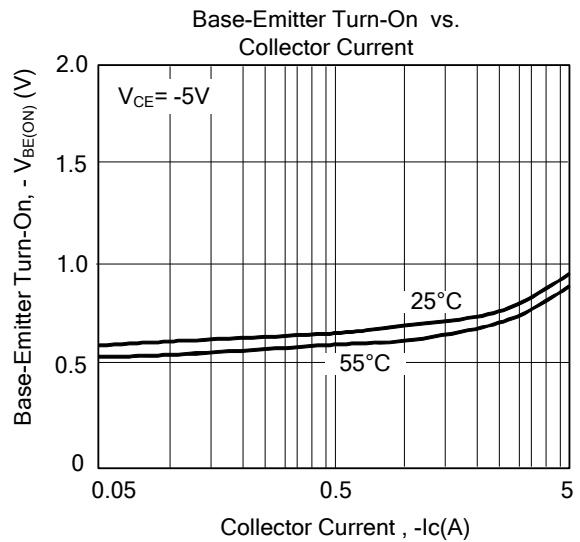
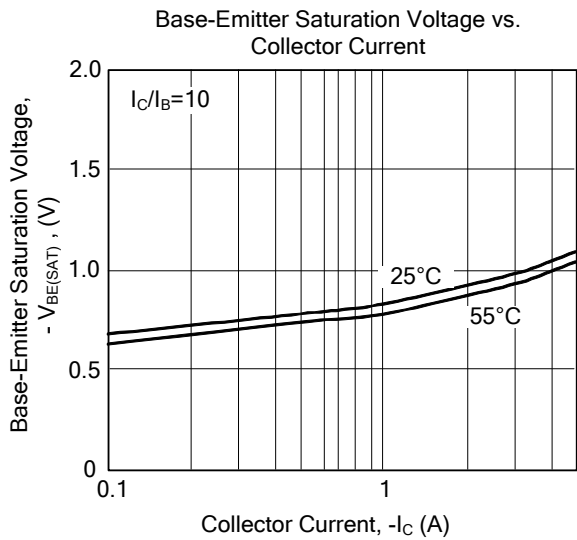
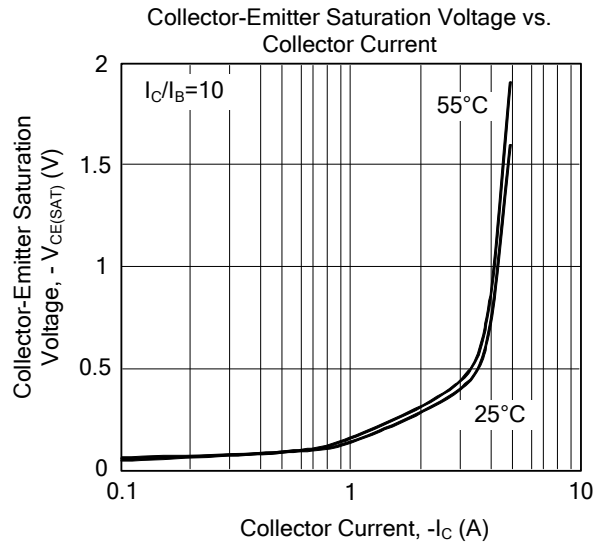
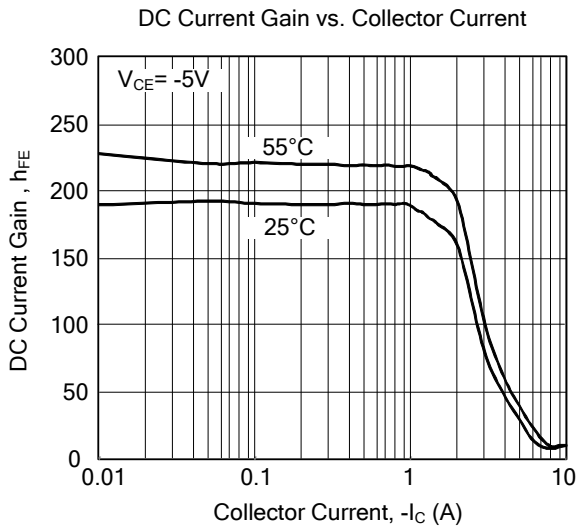

UTC assumes no responsibility for equipment failures that result from using products at values that exceed, even momentarily, rated values (such as maximum ratings, operating condition ranges, or other parameters) listed in products specifications of any and all UTC products described or contained herein. UTC products are not designed for use in life support appliances, devices or systems where malfunction of these products can be reasonably expected to result in personal injury. Reproduction in whole or in part is prohibited without the prior written consent of the copyright owner. The information presented in this document does not form part of any quotation or contract, is believed to be accurate and reliable and may be changed without notice.