



SS52C THRU SS5200C

Reverse Voltage - 20 to 200 Volts Forward Current - 5.0 Ampere

SURFACE MOUNT SCHOTTKY BARRIER RECTIFIER

Features

- ◆ The plastic package carries Underwriters Laboratory Flammability Classification 94V-0
- ◆ For surface mounted applications
- ◆ Metal silicon junction, majority carrier conduction
- ◆ Low power loss, high efficiency
- ◆ Built-in strain relief, ideal for automated placement
- ◆ High forward surge current capability
- ◆ High temperature soldering guaranteed:
250 °C/10 seconds at terminals

DO-214AB/SMC **RoHS COMPLIANT**

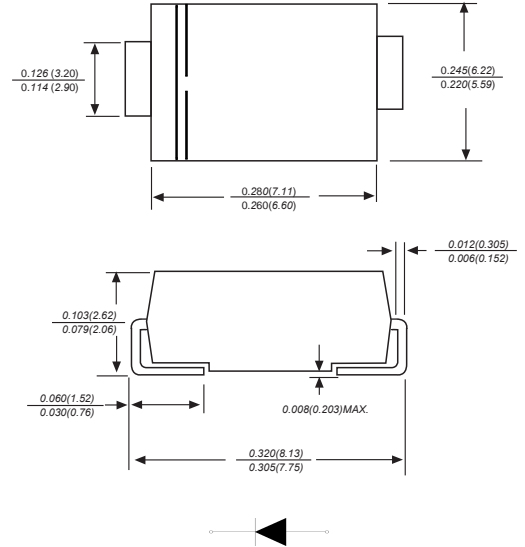

Dimensions in inches and (millimeters)

Mechanical Data

Case: JEDEC DO-214AB/SMC molded plastic body
 Terminals: Solderable per MIL-STD-750, Method 2026
 Polarity: Color band denotes cathode end Mounting
 Position: Any
 Weight: 0.007ounce, 0.25 grams

Maximum Ratings And Electrical Characteristics

Ratings at 25°C ambient temperature unless otherwise specified.

Single phase half-wave 60Hz, resistive or inductive load, for capacitive load current derate by 20%.

Parameter	SYMBOLS	SS52C	SS53C	SS54C	SS55C	SS56C	SS58C	SS510C	SS5150C	SS5200C	UNITS	
		MDD SS52C	MDD SS53C	MDD SS54C	MDD SS55C	MDD SS56C	MDD SS58C	MDD SS510C	MDD SS5150C	MDD SS5200C		
Maximum repetitive peak reverse voltage	V_{RRM}	20	30	40	50	60	80	100	150	200	V	
Maximum RMS voltage	V_{RMS}	14	21	28	35	42	56	70	105	140	V	
Maximum DC blocking voltage	V_{DC}	20	30	40	50	60	80	100	150	200	V	
Maximum average forward rectified current at TL (see fig.1)	$I_{(AV)}$	5.0									A	
Peak forward surge current 8.3ms single half sine-wave superimposed on rated load (JEDEC Method)	I_{FSM}	150									A	
Maximum instantaneous forward voltage at 5.0A	V_F	0.55			0.70		0.85		0.95		V	
Maximum DC reverse current at rated DC blocking voltage	I_R	0.5								0.2	mA	
		20				10		2.0				
Typical junction capacitance (NOTE 1)	C_J	200									pF	
Typical thermal resistance (NOTE 2)	$R_{\theta JA}$	50.0									°C/W	
Operating junction temperature range	T_J	-50 to +125					-50 to +150					°C
Storage temperature range	T_{STG}	-50 to +150									°C	

Note: 1. Measured at 1MHz and applied reverse voltage of 4.0V D.C.
 2. P.C.B. mounted with 0.2x0.2" (5.0x5.0mm) copper pad areas



SS52C THRU SS5200C

Reverse Voltage - 20 to 200 Volts Forward Current - 5.0 Ampere

Typical Characteristics

AVERAGE FORWARD RECTIFIED CURRENT, AMPERES

FIG. 1- FORWARD CURRENT DERATING CURVE

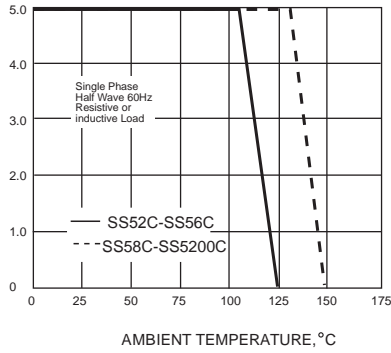

PEAK FORWARD SURGE CURRENT, AMPERES

FIG. 2-MAXIMUM NON-REPETITIVE PEAK FORWARD SURGE CURRENT

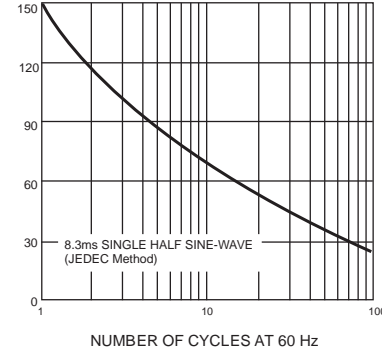

FIG. 3-TYPICAL INSTANTANEOUS FORWARD CHARACTERISTICS

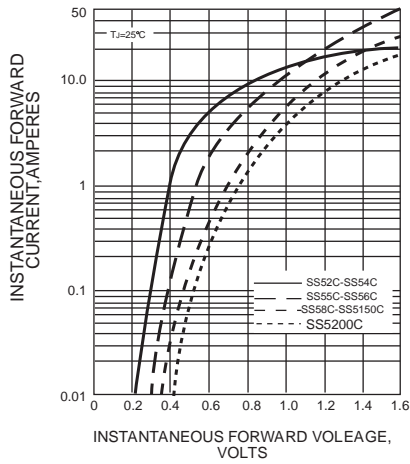

FIG. 4-TYPICAL REVERSE CHARACTERISTICS

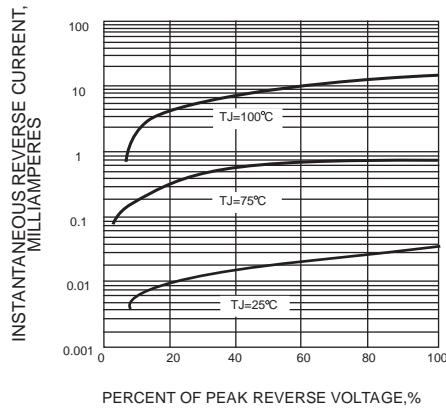

FIG. 5-TYPICAL JUNCTION CAPACITANCE

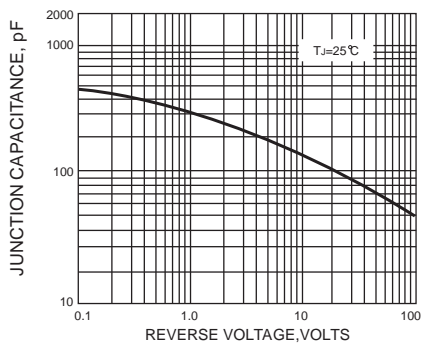
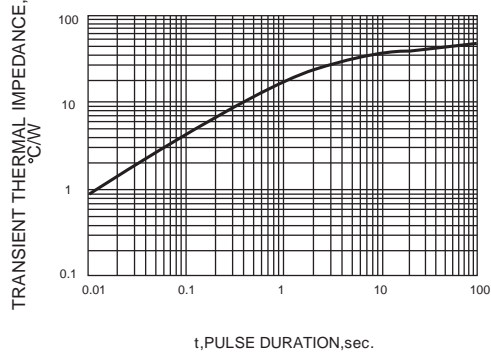

FIG. 6-TYPICAL TRANSIENT THERMAL IMPEDANCE



The curve above is for reference only.



SS52C THRU SS5200C

Reverse Voltage - 20 to 200 Volts Forward Current - 5.0 Ampere

Packing information

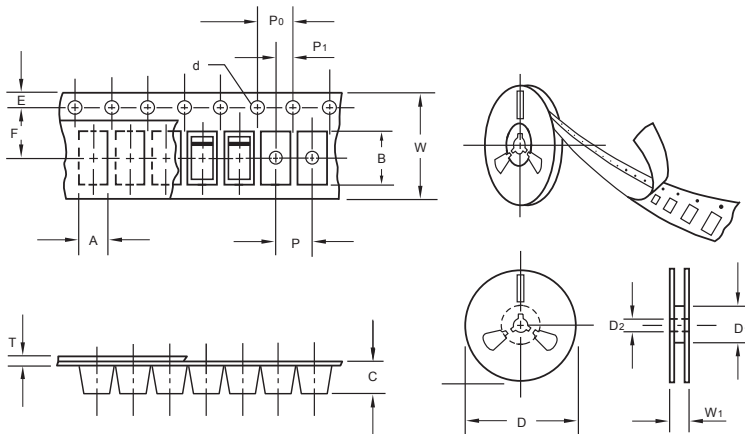

unit:mm

Item	Symbol	Tolerance	SMC
Carrier width	A	0.1	6.15
Carrier length	B	0.1	8.41
Carrier depth	C	0.1	2.42
Sprocket hole	d	0.05	1.50
13" Reel outside diameter	D	2.0	330.00
13" Reel inner diameter	D ₁	min	50.00
Feed hole diameter	D ₂	0.5	13.00
Sprocket hole position	E	0.1	1.75
Punch hole position	F	0.1	7.50
Punch hole pitch	P	0.1	8.00
Sprocket hole pitch	P ₀	0.1	4.00
Embossment center	P ₁	0.1	2.00
Overall tape thickness	T	0.1	0.25
Tape width	W	0.3	16.00
Reel width	W ₁	1.0	16.50

Note: Devices are packed in accordance with EIA standard RS-481-A and specifications listed above.

Reel packing

PACKAGE	REEL SIZE	REEL (pcs)	COMPONENT SPACING (mm)	BOX (pcs)	INNER BOX (mm)	REEL DIA. (mm)	CARTON SIZE (mm)	CARTON (pcs)	APPROX. GROSS WEIGHT (kg)
SMC	13"	3,000	4.0	6000	190*190*41	330	365*365*340	42000	14.0

Suggested Pad Layout

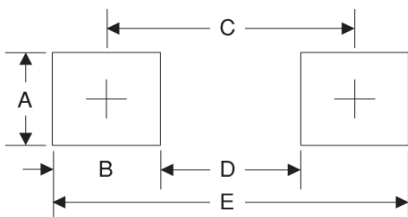

Symbol	Unit (mm)	Unit (inch)
A	4.3	0.170
B	4.1	0.160
C	7.9	0.311
D	3.8	0.150
E	12	0.472

Important Notice and Disclaimer

Microdiode Electronics (Jiangsu) reserves the right to make changes to this document and its products and specifications at any time without notice. Customers should obtain and confirm the latest product information and specifications before final design, purchase or use.

Microdiode Electronics (Jiangsu) makes no warranty, representation or guarantee regarding the suitability of its products for any particular purpose, nor does Microdiode Electronics (Jiangsu) assume any liability for application assistance or customer product design. Microdiode Electronics (Jiangsu) does not warrant or accept any liability with products which are purchased or used for any unintended or unauthorized application.

No license is granted by implication or otherwise under any intellectual property rights of Microdiode Electronics (Jiangsu).

Microdiode Electronics (Jiangsu) products are not authorized for use as critical components in life support devices or systems without express written approval of Microdiode Electronics (Jiangsu).