

# IRF6646PbF IRF6646TRPbF

DirectFET™ Power MOSFET ②

- RoHs Compliant ①
- Lead-Free (Qualified up to 260°C Reflow)
- Application Specific MOSFETs
- Ideal for High Performance Isolated Converter Primary Switch Socket
- Optimized for Synchronous Rectification
- Low Conduction Losses
- High Cdv/dt Immunity
- Low Profile (<0.7mm)
- Dual Sided Cooling Compatible ①
- Compatible with existing Surface Mount Techniques ①

Typical values (unless otherwise specified)

| V <sub>DSS</sub>   | V <sub>GS</sub> | R <sub>DS(on)</sub> |                 |                  |                     |
|--------------------|-----------------|---------------------|-----------------|------------------|---------------------|
| 80V max            | ±20V max        | 7.6mΩ @ 10V         |                 |                  |                     |
| Q <sub>g tot</sub> | Q <sub>gd</sub> | Q <sub>gs2</sub>    | Q <sub>rr</sub> | Q <sub>oss</sub> | V <sub>gs(th)</sub> |
| 36nC               | 12nC            | 2.0nC               | 48nC            | 18nC             | 3.8V                |

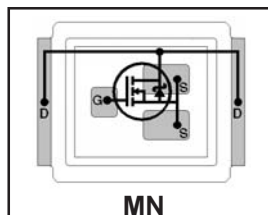

Applicable DirectFET Outline and Substrate Outline (see p.7,8 for details)①

|    |    |    |  |    |    |    |           |  |  |  |
|----|----|----|--|----|----|----|-----------|--|--|--|
| SQ | SX | ST |  | MQ | MX | MT | <b>MN</b> |  |  |  |
|----|----|----|--|----|----|----|-----------|--|--|--|

### Description

The IRF6646PbF combines the latest HEXFET® Power MOSFET Silicon technology with the advanced DirectFET™ packaging to achieve the lowest on-state resistance in a package that has the footprint of a SO-8 and only 0.7 mm profile. The DirectFET package is compatible with existing layout geometries used in power applications, PCB assembly equipment and vapor phase, infra-red or convection soldering techniques. Application note AN-1035 is followed regarding the manufacturing methods and processes. The DirectFET package allows dual sided cooling to maximize thermal transfer in power systems, improving previous best thermal resistance by 80%.

The IRF6646PbF is optimized for primary side bridge topologies in isolated DC-DC applications, for 48V(±10%) or 36V to 60V ETSI input voltage range systems, and is also ideal for secondary side synchronous rectification in regulated isolated DC-DC topologies. The reduced total losses in the device coupled with the high level of thermal performance enables high efficiency and low temperatures, which are key for system reliability improvements, and makes this device ideal for high performance isolated DC-DC converters.

### Absolute Maximum Ratings

|  | Parameter   | Max. | Units |
|--|---|------|-------|
| V <sub>DS</sub>                        | Drain-to-Source Voltage                           | 80   | V     |
| V <sub>GS</sub>                        | Gate-to-Source Voltage                            | ±20  |       |
| I <sub>D</sub> @ T <sub>A</sub> = 25°C | Continuous Drain Current, V <sub>GS</sub> @ 10V ③ | 12   | A     |
| I <sub>D</sub> @ T <sub>A</sub> = 70°C | Continuous Drain Current, V <sub>GS</sub> @ 10V ③ | 9.6  |       |
| I <sub>D</sub> @ T <sub>C</sub> = 25°C | Continuous Drain Current, V <sub>GS</sub> @ 10V ④ | 68   |       |
| I <sub>DM</sub>                        | Pulsed Drain Current ⑤                            | 96   |       |
| E <sub>AS</sub>                        | Single Pulse Avalanche Energy ⑥                   | 230  | mJ    |
| I <sub>AR</sub>                        | Avalanche Current ⑤                               | 7.2  | A     |

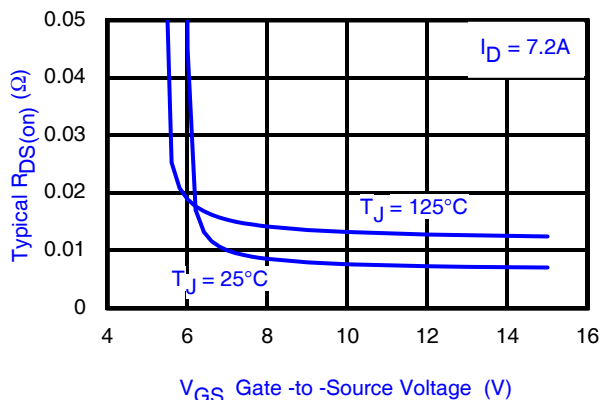

Fig 1. Typical On-Resistance vs. Gate Voltage

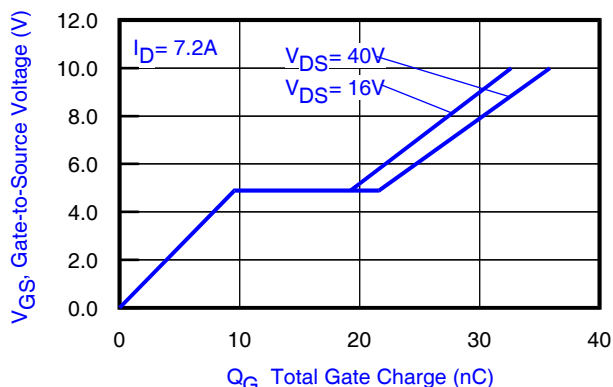

Fig 2. Typical Total Gate Charge vs. Gate-to-Source Voltage

Notes:

- ① Click on this section to link to the appropriate technical paper.
- ② Click on this section to link to the DirectFET Website.
- ③ Surface mounted on 1 in. square Cu board, steady state.

- ④ T<sub>C</sub> measured with thermocouple mounted to top (Drain) of part.
- ⑤ Repetitive rating; pulse width limited by max. junction temperature.
- ⑥ Starting T<sub>J</sub> = 25°C, L = 8.8mH, R<sub>G</sub> = 25Ω, I<sub>AS</sub> = 7.2A.

## Static @ $T_J = 25^\circ\text{C}$ (unless otherwise specified)

|                                | Parameter                            | Min. | Typ. | Max. | Units      | Conditions  |
|--------------------------------|--------------------------------------|------|------|------|------------|---|
| $BV_{DSS}$                     | Drain-to-Source Breakdown Voltage    | 80   | —    | —    | V          | $V_{GS} = 0V, I_D = 250\mu A$   |
| $\Delta BV_{DSS}/\Delta T_J$   | Breakdown Voltage Temp. Coefficient  | —    | 0.10 | —    | V/°C       | Reference to $25^\circ\text{C}, I_D = 1\text{mA}$   |
| $R_{DS(on)}$                   | Static Drain-to-Source On-Resistance | —    | 7.6  | 9.5  | m $\Omega$ | $V_{GS} = 10V, I_D = 12A$ ⑦   |
| $V_{GS(th)}$                   | Gate Threshold Voltage               | 3.0  | —    | 4.9  | V          | $V_{DS} = V_{GS}, I_D = 150\mu A$   |
| $\Delta V_{GS(th)}/\Delta T_J$ | Gate Threshold Voltage Coefficient   | —    | -11  | —    | mV/°C      |   |
| $I_{DSS}$                      | Drain-to-Source Leakage Current      | —    | —    | 20   | $\mu A$    | $V_{DS} = 80V, V_{GS} = 0V$   |
|                                |                                      | —    | —    | 250  |            | $V_{DS} = 64V, V_{GS} = 0V, T_J = 125^\circ\text{C}$  |
| $I_{GSS}$                      | Gate-to-Source Forward Leakage       | —    | —    | 100  | nA         | $V_{GS} = 20V$  |
|                                | Gate-to-Source Reverse Leakage       | —    | —    | -100 |            | $V_{GS} = -20V$   |
| $g_{fs}$                       | Forward Transconductance             | 17   | —    | —    | S          | $V_{DS} = 10V, I_D = 7.2A$  |
| $Q_g$                          | Total Gate Charge                    | —    | 36   | 50   | nC         | $V_{DS} = 40V$<br>$V_{GS} = 10V$<br>$I_D = 7.2A$<br>See Fig. 15   |
| $Q_{gs1}$                      | Pre-Vth Gate-to-Source Charge        | —    | 7.6  | —    |            |   |
| $Q_{gs2}$                      | Post-Vth Gate-to-Source Charge       | —    | 2.0  | —    |            |   |
| $Q_{gd}$                       | Gate-to-Drain Charge                 | —    | 12   | —    |            |   |
| $Q_{godr}$                     | Gate Charge Overdrive                | —    | 14   | —    |            |   |
| $Q_{sw}$                       | Switch Charge ( $Q_{gs2} + Q_{gd}$ ) | —    | 14   | —    |            |   |
| $Q_{oss}$                      | Output Charge                        | —    | 18   | —    | nC         | $V_{DS} = 16V, V_{GS} = 0V$   |
| $R_G$                          | Gate Resistance                      | —    | 1.0  | —    | $\Omega$   |   |
| $t_{d(on)}$                    | Turn-On Delay Time                   | —    | 17   | —    | ns         | $V_{DD} = 40V, V_{GS} = 10V$ ⑦<br>$I_D = 7.2A$<br>$R_G = 6.2\Omega$<br>See Fig. 16 & 17   |
| $t_r$                          | Rise Time                            | —    | 20   | —    |            |   |
| $t_{d(off)}$                   | Turn-Off Delay Time                  | —    | 31   | —    |            |   |
| $t_f$                          | Fall Time                            | —    | 12   | —    |            |   |
| $C_{iss}$                      | Input Capacitance                    | —    | 2060 | —    | pF         | $V_{GS} = 0V$<br>$V_{DS} = 25V$<br>$f = 1.0\text{MHz}$<br>$V_{GS} = 0V, V_{DS} = 1.0V, f = 1.0\text{MHz}$<br>$V_{GS} = 0V, V_{DS} = 64V, f = 1.0\text{MHz}$ |
| $C_{oss}$                      | Output Capacitance                   | —    | 480  | —    |            |   |
| $C_{rss}$                      | Reverse Transfer Capacitance         | —    | 120  | —    |            |   |
| $C_{oss}$                      | Output Capacitance                   | —    | 2180 | —    |            |   |
| $C_{oss}$                      | Output Capacitance                   | —    | 310  | —    |            |   |

## Diode Characteristics

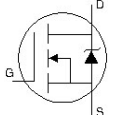
|          | Parameter                                 | Min. | Typ. | Max. | Units | Conditions   |
|----------|---|------|------|------|-------|--|
| $I_S$    | Continuous Source Current<br>(Body Diode) | —    | —    | 2.5⑧ | A     | MOSFET symbol showing the integral reverse p-n junction diode.  |
| $I_{SM}$ | Pulsed Source Current<br>(Body Diode) ⑤   | —    | —    | 96   |       |  |
| $V_{SD}$ | Diode Forward Voltage                     | —    | —    | 1.3  | V     | $T_J = 25^\circ\text{C}, I_S = 7.2A, V_{GS} = 0V$ ⑦  |
| $t_{rr}$ | Reverse Recovery Time                     | —    | 36   | 54   | ns    | $T_J = 25^\circ\text{C}, I_F = 7.2A, V_{DD} = 40V$   |
| $Q_{rr}$ | Reverse Recovery Charge                   | —    | 48   | 72   | nC    | $di/dt = 100A/\mu s$ ⑦ See Fig. 18   |

### Notes:

- ⑤ Repetitive rating; pulse width limited by max. junction temperature.
- ⑦ Pulse width  $\leq 400\mu s$ ; duty cycle  $\leq 2\%$ .
- ⑧ Thermally limited and used  $R_{\theta ja}$  to calculate.

**Absolute Maximum Ratings**

|                                | Parameter                  | Max.         | Units |
|--------------------------------|----------------------------|--------------|-------|
| $P_D @ T_A = 25^\circ\text{C}$ | Power Dissipation ③        | 2.8          | W     |
| $P_D @ T_A = 70^\circ\text{C}$ | Power Dissipation ③        | 1.8          |       |
| $P_D @ T_C = 25^\circ\text{C}$ | Power Dissipation ④        | 89           |       |
| $T_P$                          | Peak Soldering Temperature | 270          | °C    |
| $T_J$                          | Operating Junction and     | -40 to + 150 |       |
| $T_{STG}$                      | Storage Temperature Range  |              |       |

**Thermal Resistance**

|                  | Parameter                | Typ.  | Max. | Units |
|------------------|--------------------------|-------|------|-------|
| $R_{\theta JA}$  | Junction-to-Ambient ③ ①  | —     | 45   | °C/W  |
| $R_{\theta JA}$  | Junction-to-Ambient ⑨ ①  | 12.5  | —    |       |
| $R_{\theta JA}$  | Junction-to-Ambient ⑩ ①  | 20    | —    |       |
| $R_{\theta JC}$  | Junction-to-Case ④ ①     | —     | 1.4  |       |
| $R_{\theta PCB}$ | Junction-to-PCB Mounted  | 1.0   | —    |       |
|                  | Linear Derating Factor ③ | 0.022 |      |       |

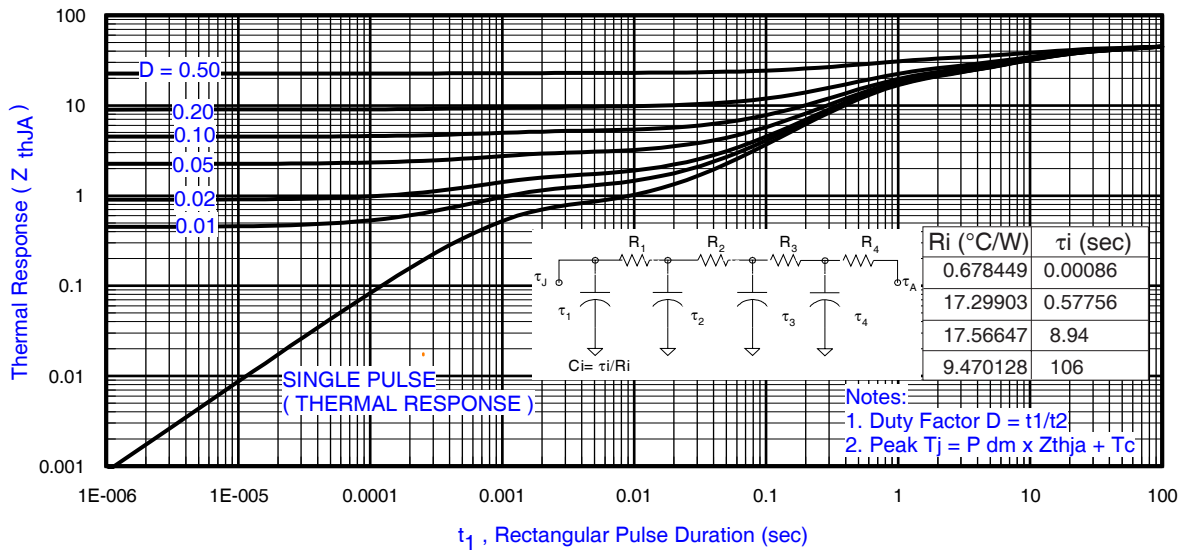

**Fig 3. Maximum Effective Transient Thermal Impedance, Junction-to-Ambient ①**

**Notes:**

- ③ Used double sided cooling , mounting pad.
- ④  $R_{\theta}$  is measured at  $T_J$  of approximately  $90^\circ\text{C}$ .
- ⑨ Mounted on minimum footprint full size board with metalized back and with small clip heatsink.



③ Surface mounted on 1 in. square Cu (still air).



⑨ Mounted to a PCB with small clip heatsink (still air)

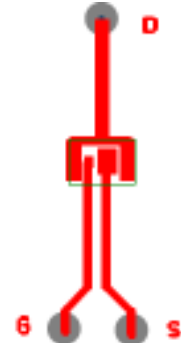

⑩ Mounted on minimum footprint full size board with metalized back and with small clip heatsink (still air)

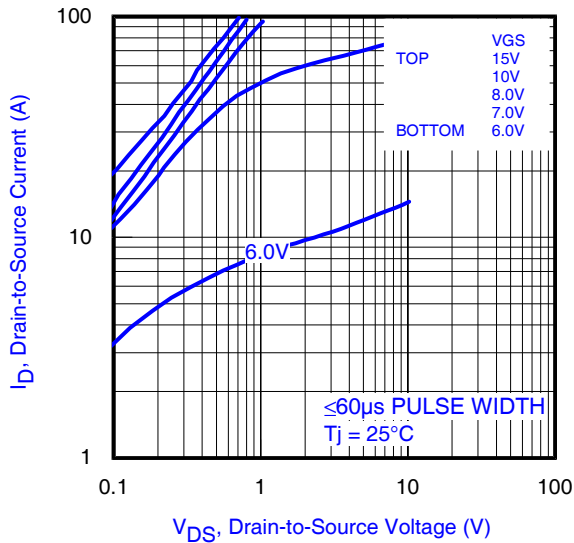

**Fig 4.** Typical Output Characteristics

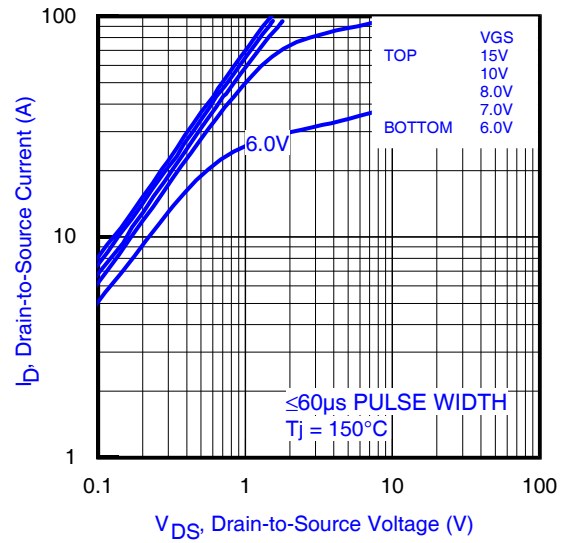

**Fig 5.** Typical Output Characteristics

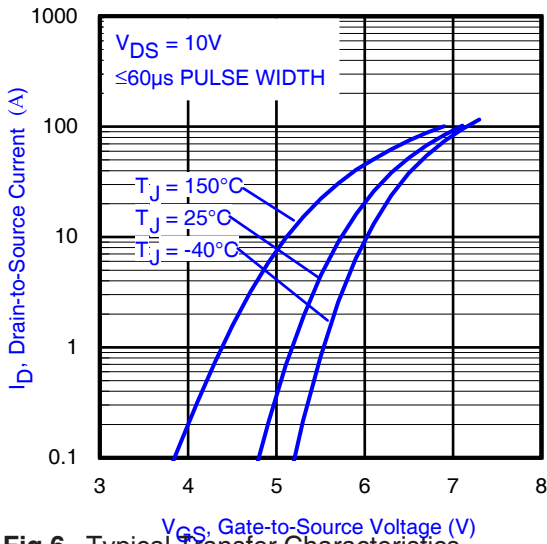

**Fig 6.** Typical Transfer Characteristics

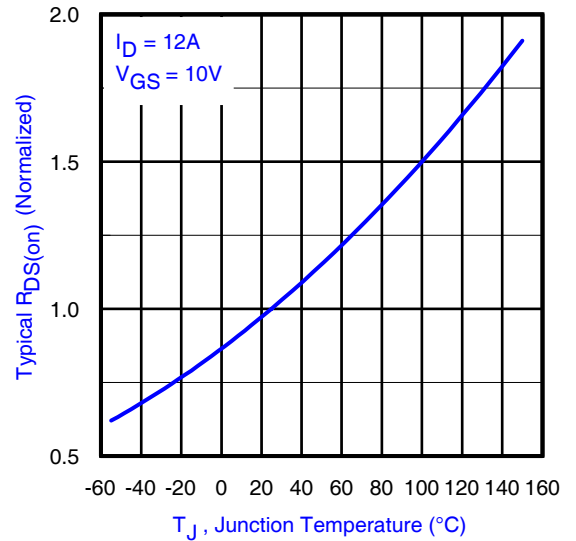

**Fig 7.** Normalized On-Resistance vs. Temperature

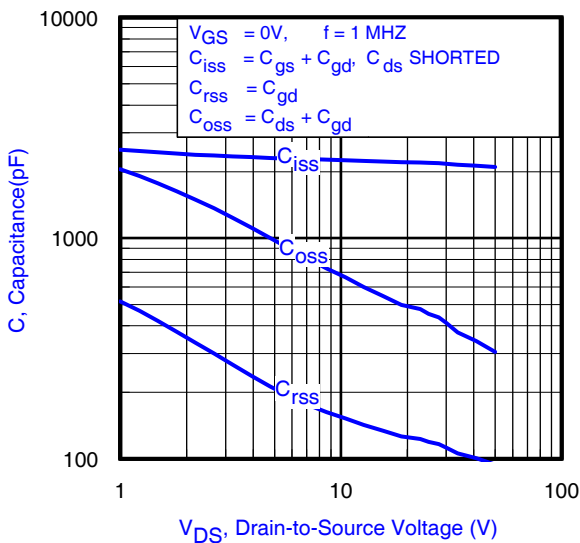

**Fig 8.** Typical Capacitance vs. Drain-to-Source Voltage

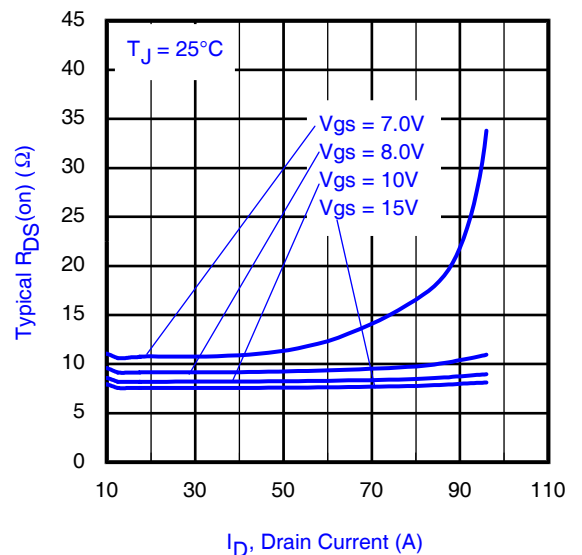

**Fig 9.** Typical On-Resistance vs. Drain Current

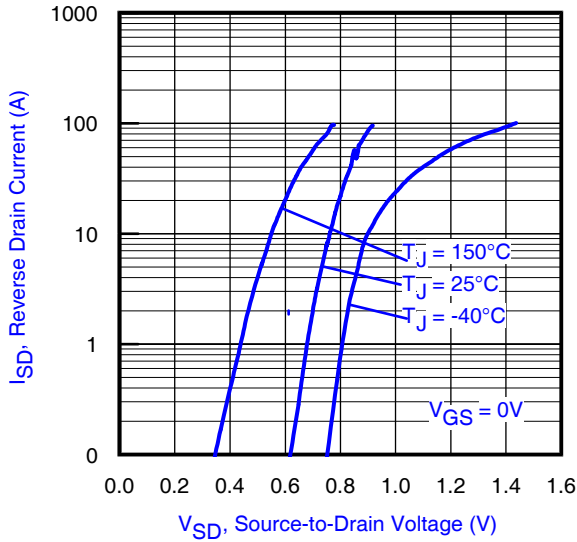

Fig 10. Typical Source-Drain Diode Forward Voltage

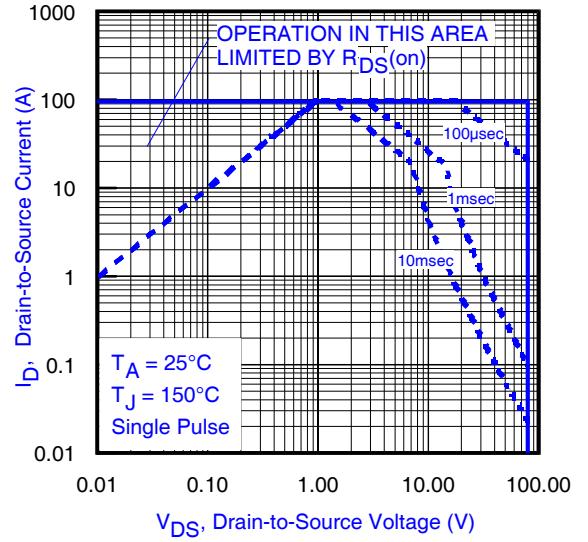

Fig11. Maximum Safe Operating Area

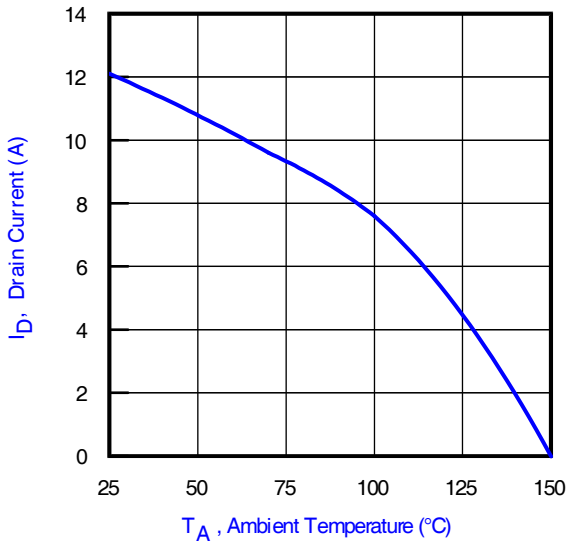

Fig 12. Maximum Drain Current vs. Ambient Temperature

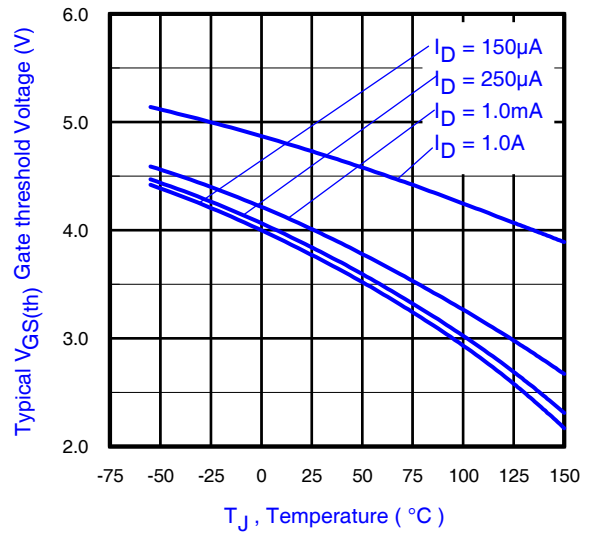

Fig 13. Typical Threshold Voltage vs. Junction Temperature

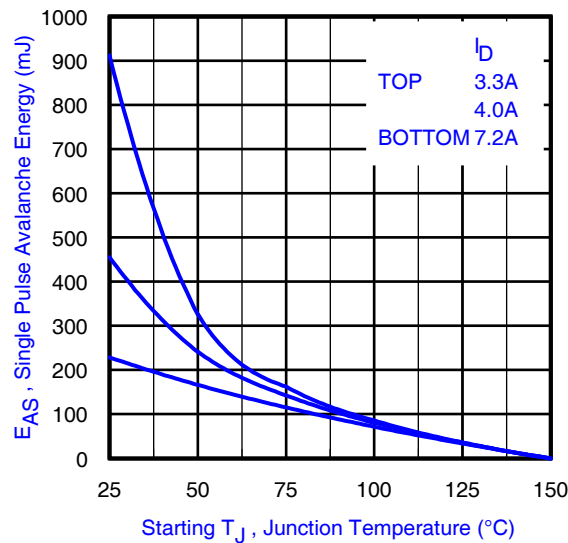
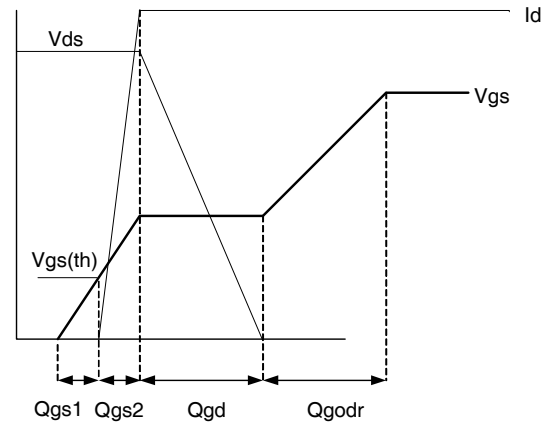

Fig 14. Maximum Avalanche Energy vs. Drain Current



**Fig 15a.** Gate Charge Test Circuit



**Fig 15b.** Gate Charge Waveform

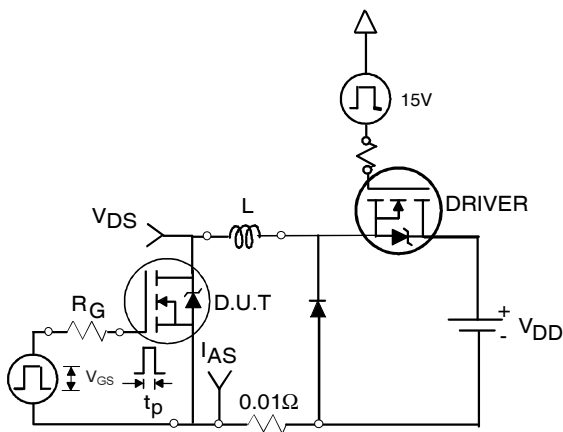

**Fig 16a.** Unclamped Inductive Test Circuit



**Fig 16b.** Unclamped Inductive Waveforms

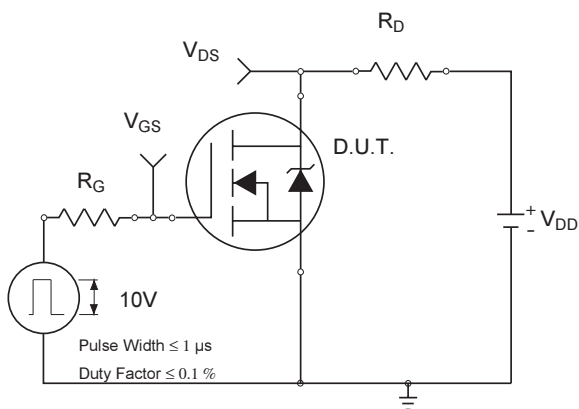

**Fig 17a.** Switching Time Test Circuit

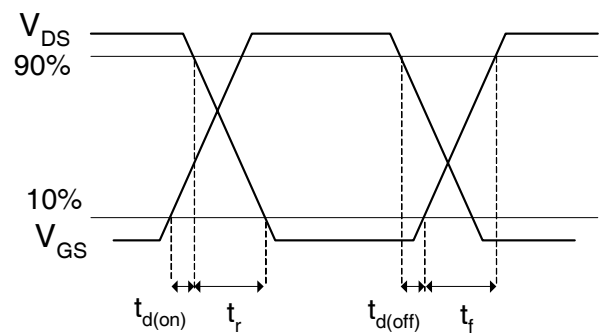

**Fig 17b.** Switching Time Waveforms

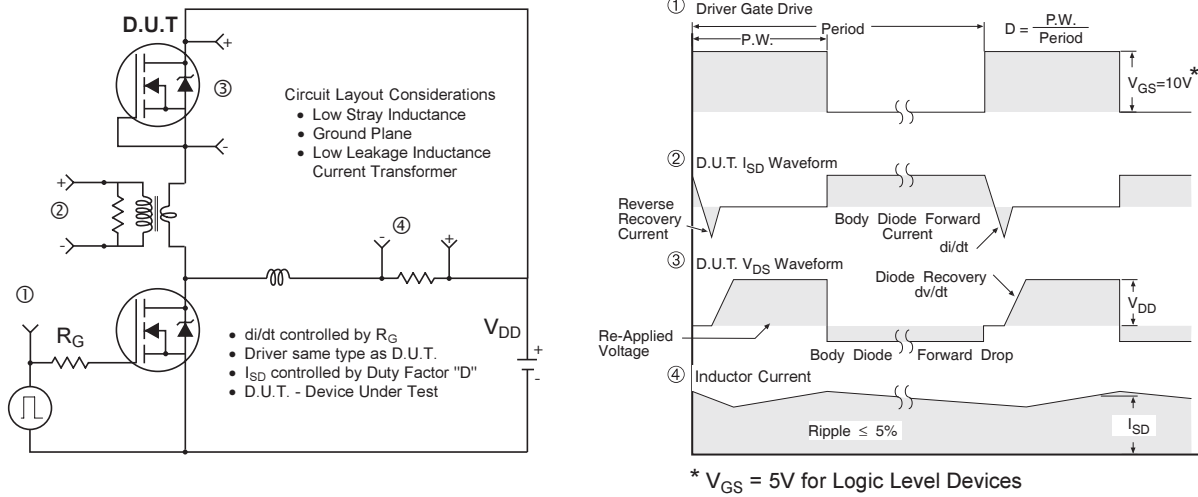
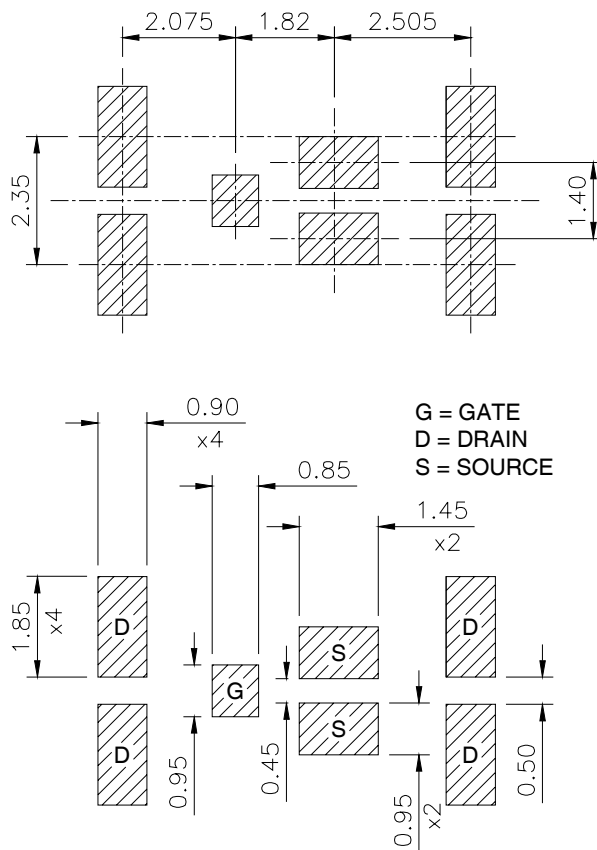

**Fig 18.** Diode Reverse Recovery Test Circuit for N-Channel HEXFET® Power MOSFETs

### DirectFET™ Substrate and PCB Layout, MN Outline (Medium Size Can, N-Designation).

Please see DirectFET application note AN-1035 for all details regarding the assembly of DirectFET.

This includes all recommendations for stencil and substrate designs.



# IRF6646PbF

## DirectFET™ Outline Dimension, MN Outline (Medium Size Can, N-Designation).

Please see DirectFET application note AN-1035 for all details regarding the assembly of DirectFET.

This includes all recommendations for stencil and substrate designs.

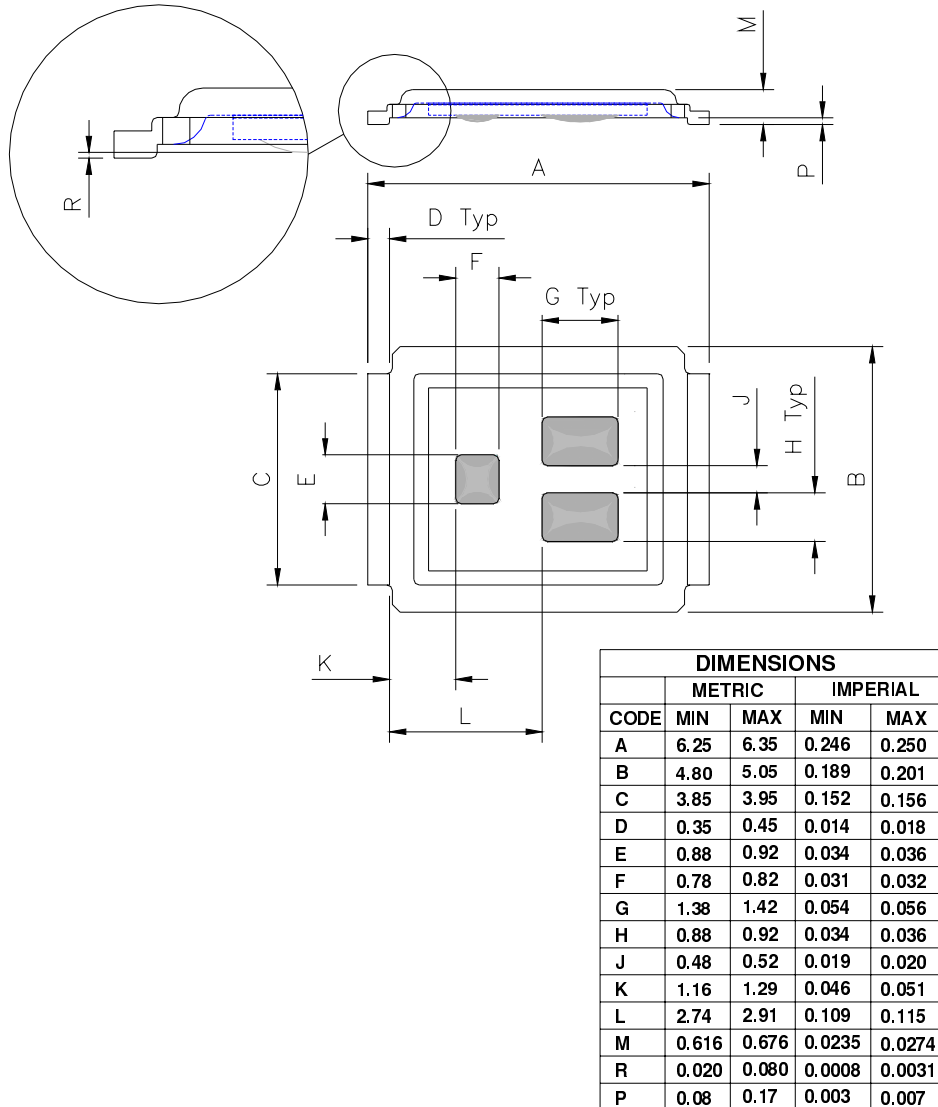

## DirectFET™ Part Marking

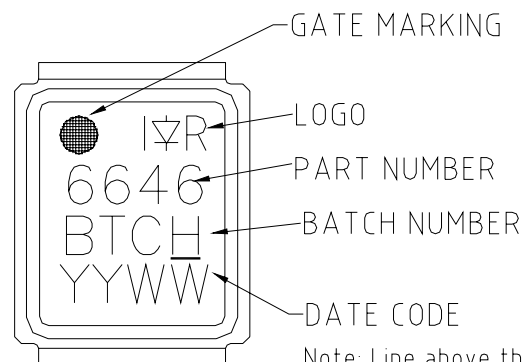

Note: Line above the last character of the date-code indicates "Lead-Free".



## DirectFET™ Tape & Reel Dimension (Showing component orientation).

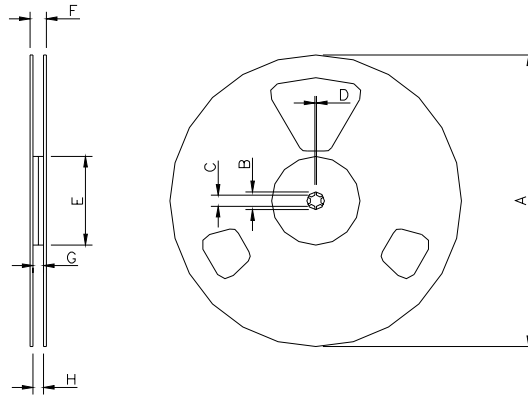

NOTE: Controlling dimensions in mm  
 Std reel quantity is 4800 parts. (ordered as IRF6646TRPBF). For 1000 parts on 7" reel, order IRF6646TR1PBF

| REEL DIMENSIONS            |        |      |          |       |                       |       |          |      |
|----------------------------|--------|------|----------|-------|-----------------------|-------|----------|------|
| STANDARD OPTION (QTY 4800) |        |      |          |       | TR1 OPTION (QTY 1000) |       |          |      |
| CODE                       | METRIC |      | IMPERIAL |       | METRIC                |       | IMPERIAL |      |
|                            | MIN    | MAX  | MIN      | MAX   | MIN                   | MAX   | MIN      | MAX  |
| A                          | 330.0  | N.C  | 12.992   | N.C   | 177.77                | N.C   | 6.9      | N.C  |
| B                          | 20.2   | N.C  | 0.795    | N.C   | 19.06                 | N.C   | 0.75     | N.C  |
| C                          | 12.8   | 13.2 | 0.504    | 0.520 | 13.5                  | 12.8  | 0.53     | 0.50 |
| D                          | 1.5    | N.C  | 0.059    | N.C   | 1.5                   | N.C   | 0.059    | N.C  |
| E                          | 100.0  | N.C  | 3.937    | N.C   | 58.72                 | N.C   | 2.31     | N.C  |
| F                          | N.C    | 18.4 | N.C      | 0.724 | N.C                   | 13.50 | N.C      | 0.53 |
| G                          | 12.4   | 14.4 | 0.488    | 0.567 | 11.9                  | 12.01 | 0.47     | N.C  |
| H                          | 11.9   | 15.4 | 0.469    | 0.606 | 11.9                  | 12.01 | 0.47     | N.C  |

LOADED TAPE FEED DIRECTION

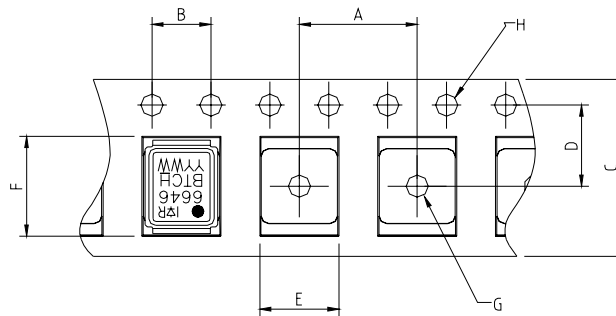

| DIMENSIONS |        |       |          |       |
|------------|--------|-------|----------|-------|
| CODE       | METRIC |       | IMPERIAL |       |
|            | MIN    | MAX   | MIN      | MAX   |
| A          | 7.90   | 8.10  | 0.311    | 0.319 |
| B          | 3.90   | 4.10  | 0.154    | 0.161 |
| C          | 11.90  | 12.30 | 0.469    | 0.484 |
| D          | 5.45   | 5.55  | 0.215    | 0.219 |
| E          | 5.10   | 5.30  | 0.201    | 0.209 |
| F          | 6.50   | 6.70  | 0.256    | 0.264 |
| G          | 1.50   | N.C   | 0.059    | N.C   |
| H          | 1.50   | 1.60  | 0.059    | 0.063 |

Data and specifications subject to change without notice.  
 This product has been designed and qualified for the Consumer market.  
 Qualification Standards can be found on IR's Web site.

Note: For the most current drawings please refer to the IR website at:  
<http://www.irf.com/package/>

## **IMPORTANT NOTICE**

The information given in this document shall in no event be regarded as a guarantee of conditions or characteristics ("Beschaffheitsgarantie").

With respect to any examples, hints or any typical values stated herein and/or any information regarding the application of the product, Infineon Technologies hereby disclaims any and all warranties and liabilities of any kind, including without limitation warranties of non-infringement of intellectual property rights of any third party.

In addition, any information given in this document is subject to customer's compliance with its obligations stated in this document and any applicable legal requirements, norms and standards concerning customer's products and any use of the product of Infineon Technologies in customer's applications.

The data contained in this document is exclusively intended for technically trained staff. It is the responsibility of customer's technical departments to evaluate the suitability of the product for the intended application and the completeness of the product information given in this document with respect to such application.

For further information on the product, technology, delivery terms and conditions and prices please contact your nearest Infineon Technologies office ([www.infineon.com](http://www.infineon.com)).

## **WARNINGS**

Due to technical requirements products may contain dangerous substances. For information on the types in question please contact your nearest Infineon Technologies office.

Except as otherwise explicitly approved by Infineon Technologies in a written document signed by authorized representatives of Infineon Technologies, Infineon Technologies' products may not be used in any applications where a failure of the product or any consequences of the use thereof can reasonably be expected to result in personal injury.