

# High Efficiency Thyristor

$$V_{RRM} = 1200 \text{ V}$$

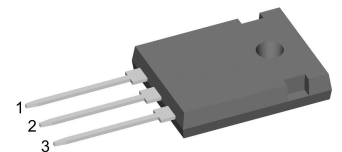
$$I_{TAV} = 40 \text{ A}$$

$$V_T = 1.26 \text{ V}$$

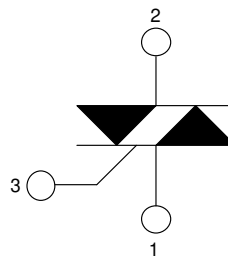
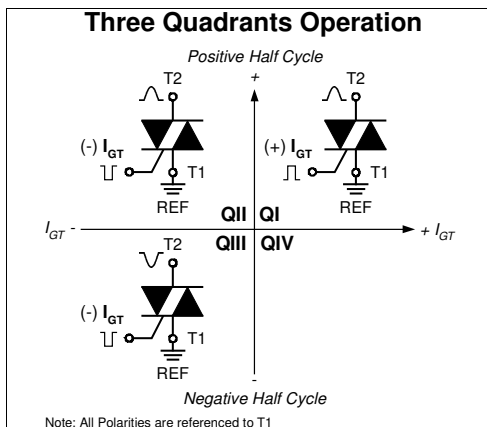
Three Quadrants operation: QI - QIII  
 1~ Triac

Part number

**CLA80MT1200NHB**



Backside: Terminal 2



## Features / Advantages:

- Triac for line frequency
- Three Quadrants Operation - QI - QIII
- Planar passivated chip
- Long-term stability of blocking currents and voltages

## Applications:

- Line rectifying 50/60 Hz
- Softstart AC motor control
- DC Motor control
- Power converter
- AC power control
- Lighting and temperature control

## Package: TO-247

- Industry standard outline
- RoHS compliant
- Epoxy meets UL 94V-0

## Disclaimer Notice

Information furnished is believed to be accurate and reliable. However, users should independently evaluate the suitability of and test each product selected for their own applications. Littelfuse products are not designed for, and may not be used in, all applications. Read complete Disclaimer Notice at [www.littelfuse.com/disclaimer-electronics](http://www.littelfuse.com/disclaimer-electronics).

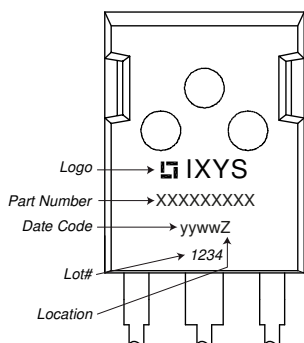


Rectifier			Ratings			
Symbol	Definition	Conditions	min.	typ.	max.	Unit
$V_{RSM/DSM}$	max. non-repetitive reverse/forward blocking voltage	$T_{VJ} = 25^{\circ}\text{C}$			1300	V
$V_{RRM/DRM}$	max. repetitive reverse/forward blocking voltage	$T_{VJ} = 25^{\circ}\text{C}$			1200	V
$I_{RD}$	reverse current, drain current	$V_{R/D} = 1200\text{ V}$	$T_{VJ} = 25^{\circ}\text{C}$		10	$\mu\text{A}$
		$V_{R/D} = 1200\text{ V}$	$T_{VJ} = 125^{\circ}\text{C}$		2	mA
$V_T$	forward voltage drop	$I_T = 40\text{ A}$	$T_{VJ} = 25^{\circ}\text{C}$		1.30	V
		$I_T = 80\text{ A}$			1.59	V
		$I_T = 40\text{ A}$	$T_{VJ} = 125^{\circ}\text{C}$		1.26	V
		$I_T = 80\text{ A}$			1.64	V
$I_{TAV}$	average forward current	$T_C = 120^{\circ}\text{C}$	$T_{VJ} = 150^{\circ}\text{C}$		40	A
$I_{RMS}$	RMS forward current per phase	180° sine			88	A
$V_{T0}$	threshold voltage	} for power loss calculation only	$T_{VJ} = 150^{\circ}\text{C}$		0.88	V
$r_T$	slope resistance				10	m $\Omega$
$R_{thJC}$	thermal resistance junction to case				0.4	K/W
$R_{thCH}$	thermal resistance case to heatsink			0.3		K/W
$P_{tot}$	total power dissipation		$T_C = 25^{\circ}\text{C}$		310	W
$I_{TSM}$	max. forward surge current	$t = 10\text{ ms}; (50\text{ Hz}), \text{ sine}$	$T_{VJ} = 45^{\circ}\text{C}$		520	A
		$t = 8,3\text{ ms}; (60\text{ Hz}), \text{ sine}$	$V_R = 0\text{ V}$		560	A
		$t = 10\text{ ms}; (50\text{ Hz}), \text{ sine}$	$T_{VJ} = 150^{\circ}\text{C}$		440	A
		$t = 8,3\text{ ms}; (60\text{ Hz}), \text{ sine}$	$V_R = 0\text{ V}$		475	A
$I^2t$	value for fusing	$t = 10\text{ ms}; (50\text{ Hz}), \text{ sine}$	$T_{VJ} = 45^{\circ}\text{C}$		1.35	kA <sup>2</sup> s
		$t = 8,3\text{ ms}; (60\text{ Hz}), \text{ sine}$	$V_R = 0\text{ V}$		1.31	kA <sup>2</sup> s
		$t = 10\text{ ms}; (50\text{ Hz}), \text{ sine}$	$T_{VJ} = 150^{\circ}\text{C}$		970	A <sup>2</sup> s
		$t = 8,3\text{ ms}; (60\text{ Hz}), \text{ sine}$	$V_R = 0\text{ V}$		940	A <sup>2</sup> s
$C_J$	junction capacitance	$V_R = 400\text{ V}$ $f = 1\text{ MHz}$	$T_{VJ} = 25^{\circ}\text{C}$		25	pF
$P_{GM}$	max. gate power dissipation	$t_p = 30\text{ }\mu\text{s}$	$T_C = 150^{\circ}\text{C}$		10	W
		$t_p = 300\text{ }\mu\text{s}$			5	W
$P_{GAV}$	average gate power dissipation				0.5	W
$(di/dt)_{cr}$	critical rate of rise of current	$T_{VJ} = 150^{\circ}\text{C}; f = 50\text{ Hz}$ repetitive, $I_T = 120\text{ A}$			150	A/ $\mu\text{s}$
		$t_p = 200\text{ }\mu\text{s}; di_G/dt = 0.3\text{ A}/\mu\text{s};$ $I_G = 0.3\text{ A}; V = \frac{2}{3} V_{DRM}$ non-repet., $I_T = 40\text{ A}$			500	A/ $\mu\text{s}$
$(dv/dt)_{cr}$	critical rate of rise of voltage	$V = \frac{2}{3} V_{DRM}$	$T_{VJ} = 150^{\circ}\text{C}$		500	V/ $\mu\text{s}$
		$R_{GK} = \infty$ ; method 1 (linear voltage rise)				
$V_{GT}$	gate trigger voltage	$V_D = 6\text{ V}$	$T_{VJ} = 25^{\circ}\text{C}$		1.7	V
			$T_{VJ} = -40^{\circ}\text{C}$		1.9	V
$I_{GT}$	gate trigger current	$V_D = 6\text{ V}$	$T_{VJ} = 25^{\circ}\text{C}$		$\pm 70$	mA
			$T_{VJ} = -40^{\circ}\text{C}$		$\pm 90$	mA
$V_{GD}$	gate non-trigger voltage	$V_D = \frac{2}{3} V_{DRM}$	$T_{VJ} = 150^{\circ}\text{C}$		0.2	V
$I_{GD}$	gate non-trigger current				$\pm 1$	mA
$I_L$	latching current	$t_p = 10\text{ }\mu\text{s}$	$T_{VJ} = 25^{\circ}\text{C}$		100	mA
		$I_G = 0.3\text{ A}; di_G/dt = 0.3\text{ A}/\mu\text{s}$				
$I_H$	holding current	$V_D = 6\text{ V}$ $R_{GK} = \infty$	$T_{VJ} = 25^{\circ}\text{C}$		70	mA
$t_{gd}$	gate controlled delay time	$V_D = \frac{1}{2} V_{DRM}$	$T_{VJ} = 25^{\circ}\text{C}$		2	$\mu\text{s}$
		$I_G = 0.3\text{ A}; di_G/dt = 0.3\text{ A}/\mu\text{s}$				
$t_q$	turn-off time	$V_R = 100\text{ V}; I_T = 40\text{ A}; V = \frac{2}{3} V_{DRM}$ $T_{VJ} = 125^{\circ}\text{C}$ $di/dt = 10\text{ A}/\mu\text{s}$ $dv/dt = 20\text{ V}/\mu\text{s}$ $t_p = 200\text{ }\mu\text{s}$		150		$\mu\text{s}$



Package TO-247			Ratings			
Symbol	Definition	Conditions	min.	typ.	max.	Unit
$I_{RMS}$	RMS current	per terminal			70	A
$T_{VJ}$	virtual junction temperature		-40		150	°C
$T_{op}$	operation temperature		-40		125	°C
$T_{stg}$	storage temperature		-40		150	°C
<b>Weight</b>				6		g
$M_D$	mounting torque		0.8		1.2	Nm
$F_C$	mounting force with clip		20		120	N

**Product Marking**



**Part description**

- C = Thyristor (SCR)
- L = High Efficiency Thyristor
- A = (up to 1200V)
- 80 = Current Rating [A]
- MT = 1~ Triac
- 1200 = Reverse Voltage [V]
- N = Three Quadrants operation: QI - QIII
- HB = TO-247AD (3)

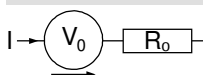
Ordering	Ordering Number	Marking on Product	Delivery Mode	Quantity	Code No.
Standard	CLA80MT1200NHB	CLA80MT1200NHB	Tube	30	517024

Similar Part	Package	Voltage class
CLA80MT1200NHR	ISO247 (3)	1200

**Equivalent Circuits for Simulation**

\* on die level

$T_{VJ} = 150^{\circ}C$



**Thyristor**

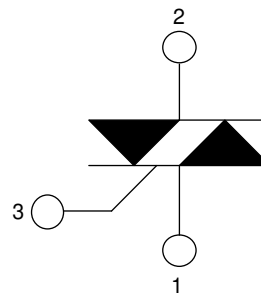
$V_{0\ max}$	threshold voltage	0.88	V
$R_{0\ max}$	slope resistance *	7.5	mΩ



**Outlines TO-247**



Sym.	Inches		Millimeter	
	min.	max.	min.	max.
A	0.185	0.209	4.70	5.30
A1	0.087	0.102	2.21	2.59
A2	0.059	0.098	1.50	2.49
D	0.819	0.845	20.79	21.45
E	0.610	0.640	15.48	16.24
E2	0.170	0.216	4.31	5.48
e	0.215	BSC	5.46	BSC
L	0.780	0.800	19.80	20.30
L1	-	0.177	-	4.49
Ø P	0.140	0.144	3.55	3.65
Q	0.212	0.244	5.38	6.19
S	-	0.242 BSC	-	6.14 BSC
b	0.039	0.055	0.99	1.40
b2	0.065	0.094	1.65	2.39
b4	0.102	0.135	2.59	3.43
c	0.015	0.035	0.38	0.89
D1	0.515	-	13.07	-
D2	0.020	0.053	0.51	1.35
E1	0.530	-	13.45	-
Ø P1	-	0.29	-	7.39



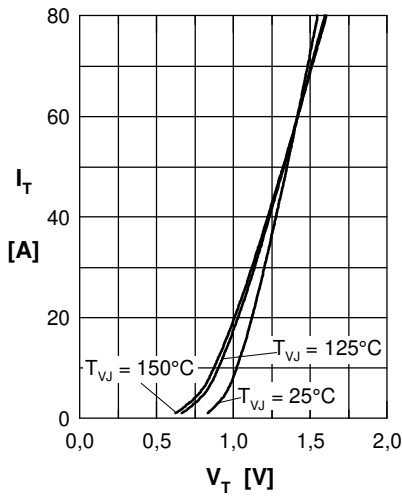
**Thyristor**


Fig. 1 Forward characteristics

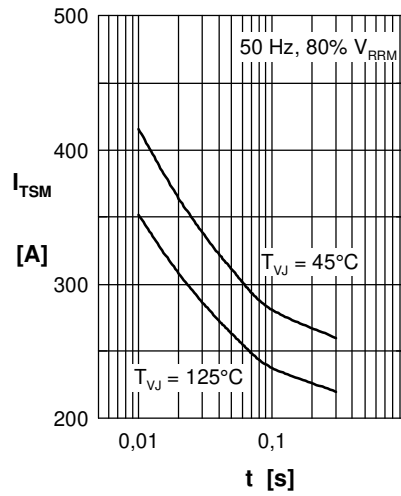
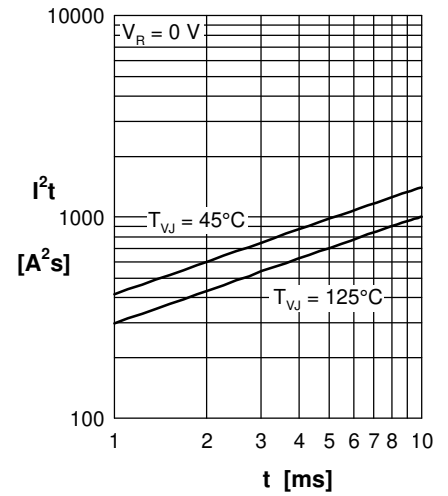
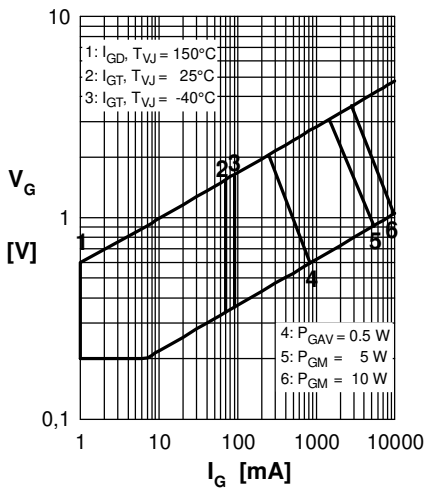

 Fig. 2 Surge overload current  
 $I_{TSM}$ : crest value,  $t$ : duration

 Fig. 3  $I^2t$  versus time (1-10 s)


Fig. 4 Gate voltage &amp; gate current

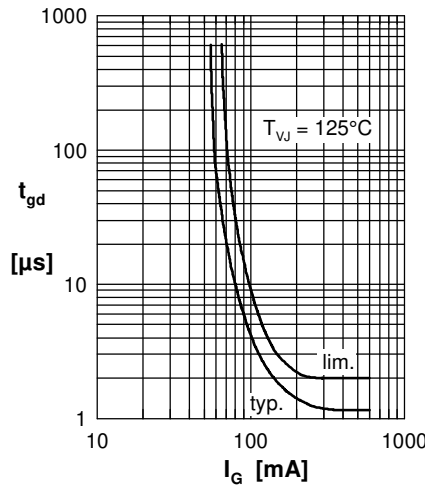
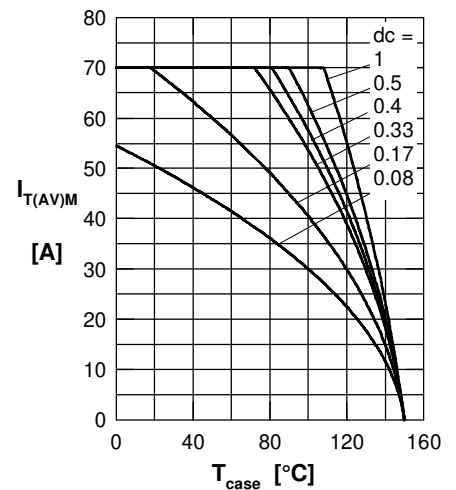

 Fig. 5 Gate controlled delay time  $t_{gd}$ 


Fig. 6 Max. forward current at case temperature

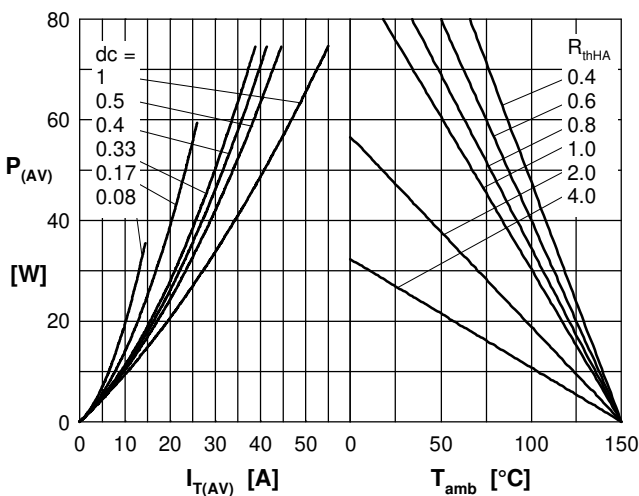
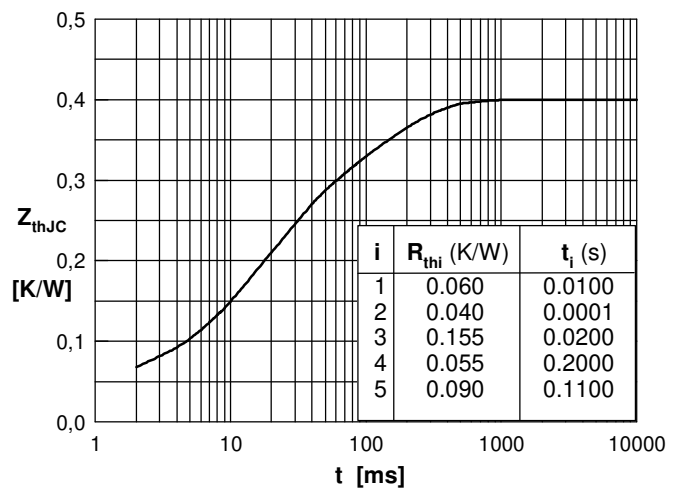

 Fig. 7a Power dissipation versus direct output current  
 Fig. 7b and ambient temperature


Fig. 7 Transient thermal impedance junction to case