

## AC and Pulse Metallized Polypropylene Film Capacitors MKP Radial Potted Type

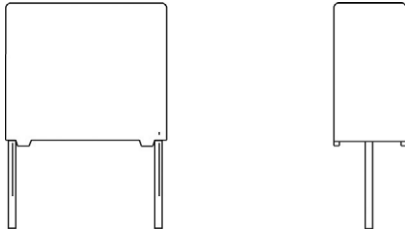

### FEATURES

- 5 mm to 52.5 mm lead pitch; 7.5 mm bent back pitch
- Low contact resistance
- Low loss dielectric
- Small dimensions for high density packaging
- Supplied loose in box and taped on reel or ammpack
- Material categorization: for definitions of compliance please see [www.vishay.com/doc?99912](http://www.vishay.com/doc?99912)



**RoHS**  
COMPLIANT  
HALOGEN  
**FREE**  
**GREEN**  
(5-2008)

### APPLICATIONS

- Where steep pulses occur e.g. SMPS (switch mode power supplies)
- Electronic lighting e.g. ballast
- Motor control circuits
- High frequency and pulse operations
- Deflection circuits in TV-sets (S-correction)
- Loudspeaker crossover networks, storage, filter, timing and sample and hold circuits

QUICK REFERENCE DATA	
Capacitance range (E24 series)	0.00047 $\mu$ F to 82 $\mu$ F
Capacitance tolerance	$\pm 5\%$
Climatic testing class according to IEC 60068-1	55/110/56
Rated DC temperature	85 °C
Rated AC temperature	85 °C
Maximum application temperature	110 °C
Maximum operating temperature for limited time	125 °C
Reference specifications	IEC 60384-17
Dielectric	Polypropylene film
Electrodes	Metallized
Construction	Mono and internal serial construction
Encapsulation	Flame retardant plastic case and epoxy resin UL-class 94 V-0
Leads	Tinned wire
Marking	C-value; tolerance; rated voltage; manufacturer's type; code for dielectric material; manufacturer location; manufacturer's logo; year and week

#### Note

- For more detailed data and test requirements, contact [dc-film@vishay.com](mailto:dc-film@vishay.com)

VOLTAGE RATINGS										
Rated DC voltage	160	250	400	630	850	1000	1250	1600	2000	2500
Rated AC voltage	110	160	200	220	300	350	450	550	700 <sup>(1)</sup>	900 <sup>(2)</sup>
Rated peak to peak voltage	310	450	560	620	850	1000	1250	1600	2000	2500

#### Notes

- (1) Rated AC voltage is 600  $V_{AC}$  for pitch  $\geq 37.5$  mm  
 (2) Rated AC voltage is 800  $V_{AC}$  for pitch  $\geq 37.5$  mm

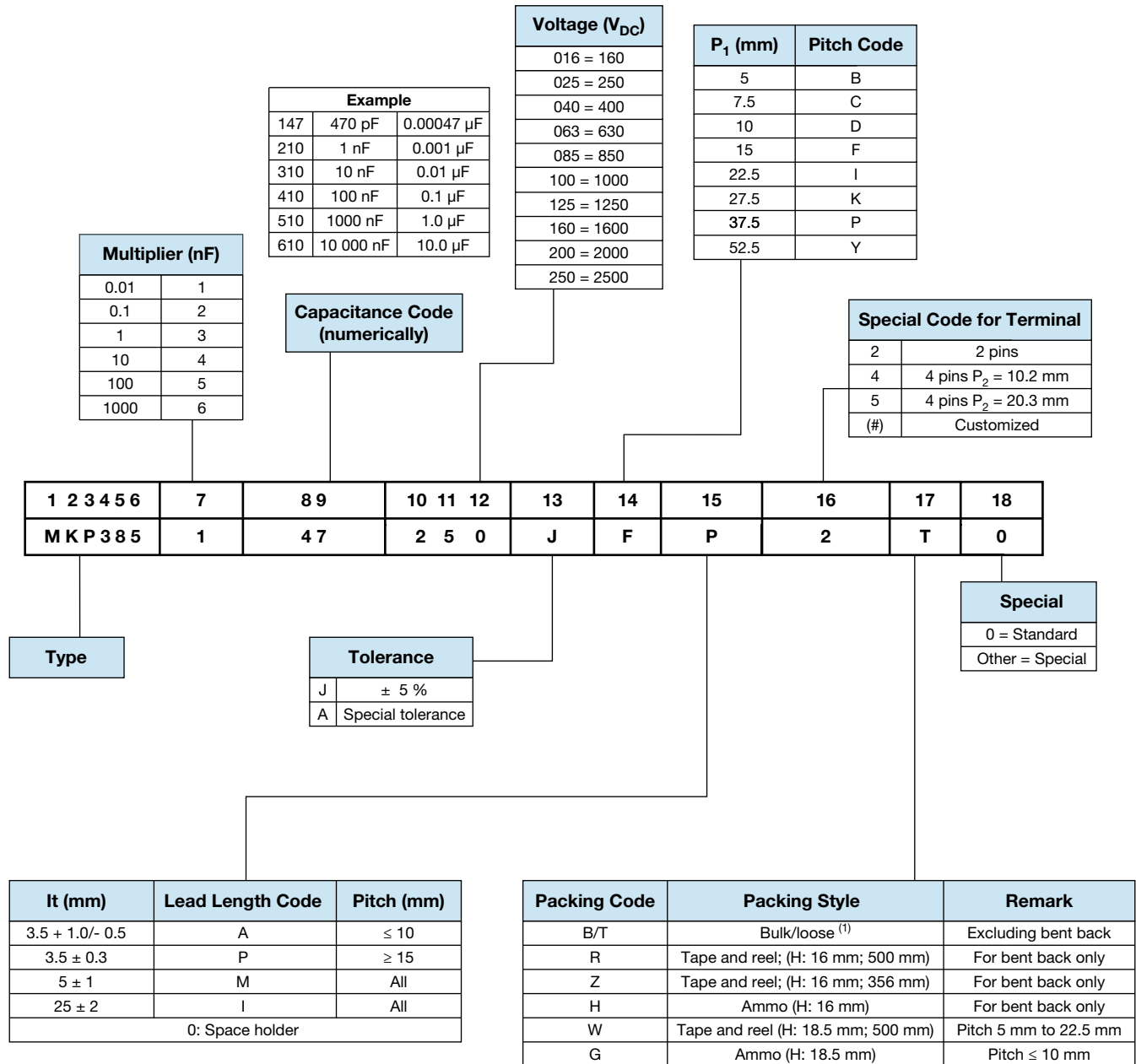
**COMPOSITION OF CATALOG NUMBER**

**Notes**

- For detailed tape specifications refer to packaging information [www.vishay.com/doc?28139](http://www.vishay.com/doc?28139)
- <sup>(1)</sup> Packaging will be bulk for all capacitors with pitch ≤ 15 mm and such with long leads (> 5 mm). Capacitors with short leads up to 5 mm and pitch > 15 mm will be in tray and asking code will be "T".

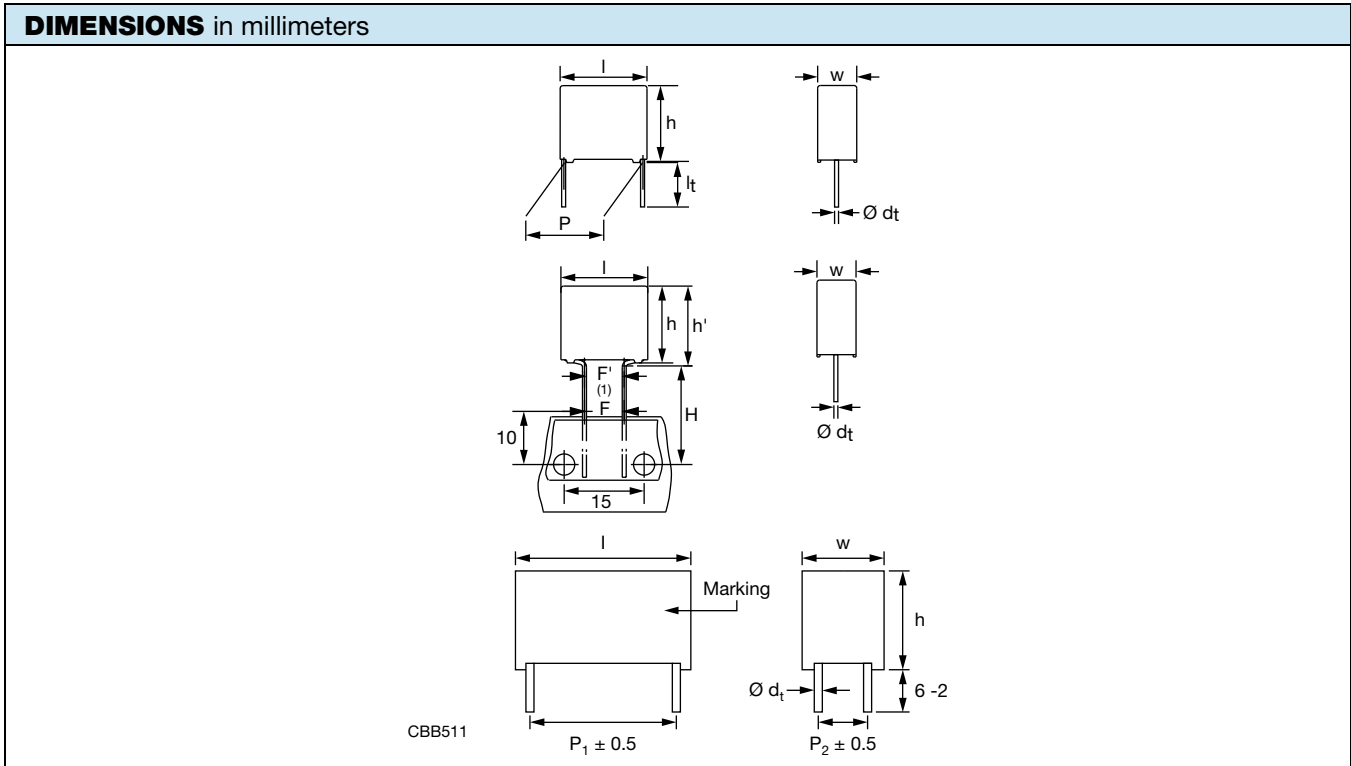
<b>ELECTRICAL DATA</b> (For Detailed Ratings go to <a href="http://www.vishay.com/doc?28182">www.vishay.com/doc?28182</a> )	
$U_{RDC}$ (V)	CAP. ( $\mu$ F)
160	0.011 min.
	82 max.
250	0.010 min.
	62 max.
400	0.0043 min.
	27 max.
630	0.0015 min.
	15 max.
850	0.001 min.
	10 max.
1000	0.00047 min.
	6.8 max.
1250	0.00047 min.
	5.1 max.
1600	0.00047 min.
	2.7 max.
2000	0.00047 min.
	1.6 max.
2500	0.00047 min.
	0.68 max.

**Note**

- $|F-F'| < 0.3$  mm  
 $F = 7.5$  mm + 0.6 mm / - 0.1 mm  
 $\varnothing dt \pm 10$  % of standard diameter specified

## MOUNTING

### Normal Use

The capacitors are designed for mounting on printed-circuit boards. The capacitors packed in bandoliers are designed for mounting on printed-circuit boards by means of automatic insertion machines.

For detailed tape specifications refer to “Packaging Information” [www.vishay.com/doc?28139](http://www.vishay.com/doc?28139)

### Specific Method of Mounting to Withstand Vibration and Shock

In order to withstand vibration and shock tests, it must be ensured that the stand-off pips are in good contact with the printed-circuit board:

- For original pitch = 15 mm the capacitors shall be mechanically fixed by the leads
- For larger pitches the capacitors shall be mounted in the same way and the body clamped

### Space Requirements on Printed-Circuit Board

The maximum length and width of film capacitors is shown in the drawing:

For products with pitch  $\leq 15$  mm,  $\Delta w = \Delta l = 0.3$  mm and  $\Delta h = 0.1$  mm

For products with  $15 \text{ mm} < \text{pitch} \leq 27.5$  mm,  $\Delta w = \Delta l = 0.5$  mm and  $\Delta h = 0.1$  mm

For products with pitch = 37.5 mm  $\Delta w = \Delta l = 0.7$  mm and  $\Delta h = 0.5$  mm

For products with pitch = 52.5 mm,  $\Delta w = \Delta l = 1$  mm and  $\Delta h = 0.5$  mm

Eccentricity as in drawing. The maximum eccentricity is smaller than or equal to the lead diameter of the product concerned.

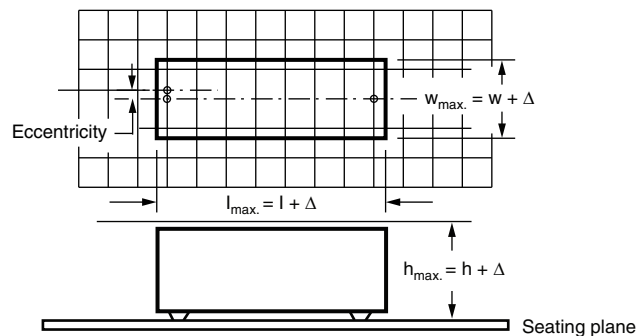

## SOLDERING CONDITIONS

For general soldering conditions and wave soldering profile we refer to the document “Soldering Conditions Vishay Film Capacitors”: [www.vishay.com/doc?28171](http://www.vishay.com/doc?28171)

## STORAGE TEMPERATURE

Storage temperature:  $T_{stg} = -25$  °C to  $+35$  °C with RH maximum 75 % without condensation.

## RATINGS AND CHARACTERISTICS REFERENCE CONDITIONS

Unless otherwise specified, all electrical values apply to an ambient free temperature of  $23$  °C  $\pm 1$  °C, an atmospheric pressure of 86 kPa to 106 kPa and a relative humidity of  $50$  %  $\pm 2$  %.

For reference testing, a conditioning period shall be applied over  $96$  h  $\pm 4$  h by heating the products in a circulating air oven at the rated temperature and a relative humidity not exceeding 20 %.



CHARACTERISTICS

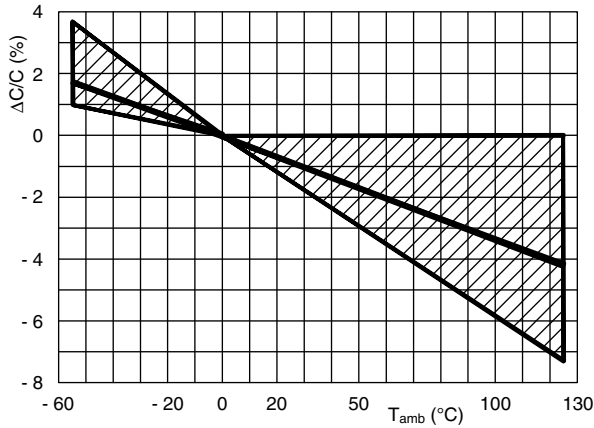

Capacitance as a function of ambient temperature (typical curve) (1 kHz)

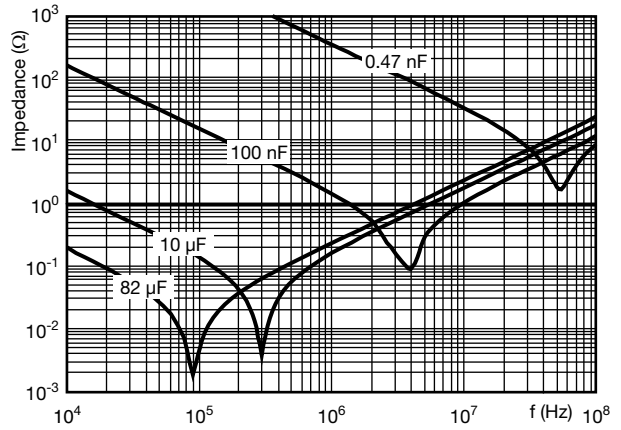

Impedance as a function of frequency (typical curve)

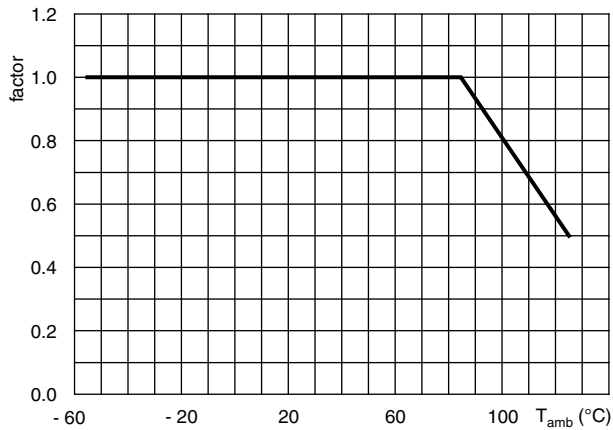

Max. DC and AC voltage as function of temperature

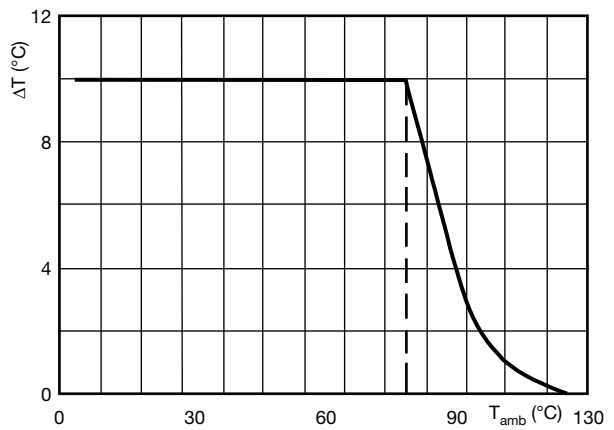

Maximum allowed component temperature rise ( $\Delta T$ ) as a function of ambient temperature ( $T_{amb}$ )

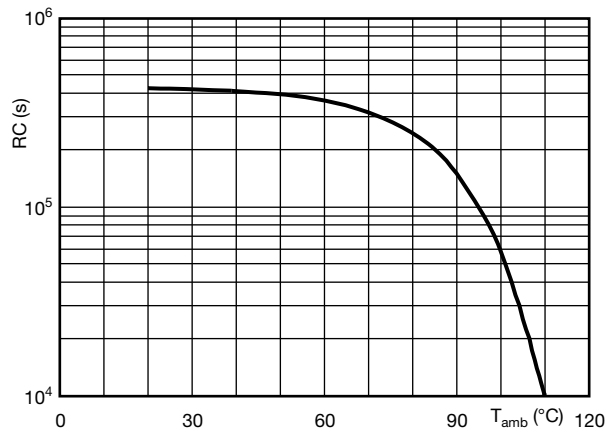

Insulation resistance as a function of ambient temperature (typical curve)

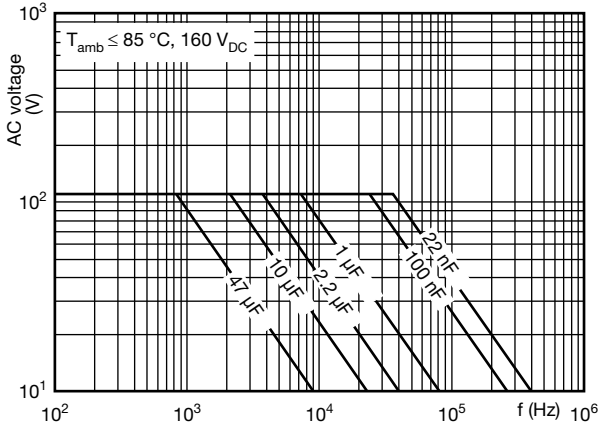

Max. RMS voltage as function of frequency (160 V)

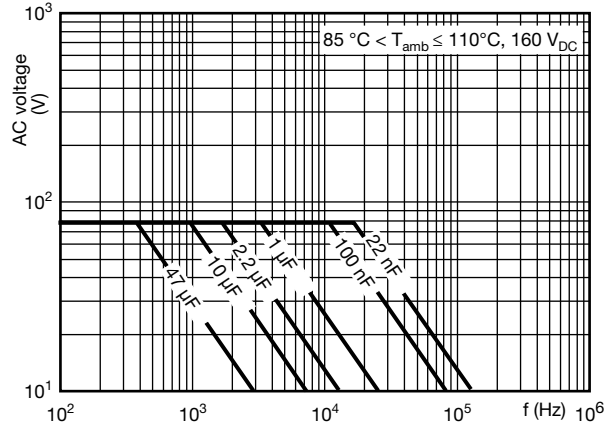

Max. RMS voltage as function of frequency (160 V)

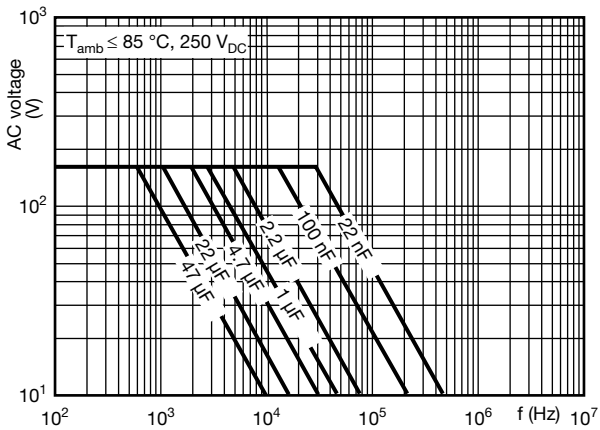

Max. RMS voltage as function of frequency (250 V)

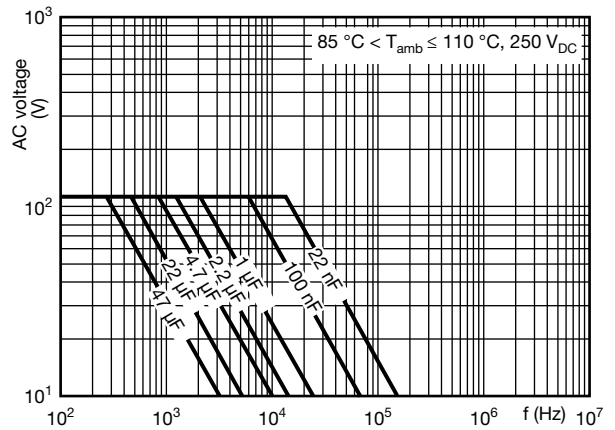

Max. RMS voltage as function of frequency (250 V)

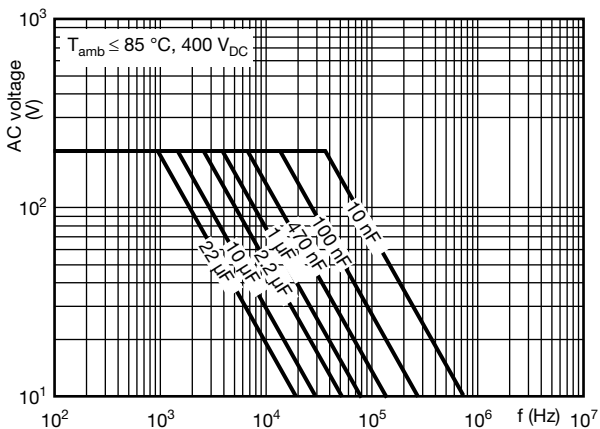

Max. RMS voltage as function of frequency (400 V)

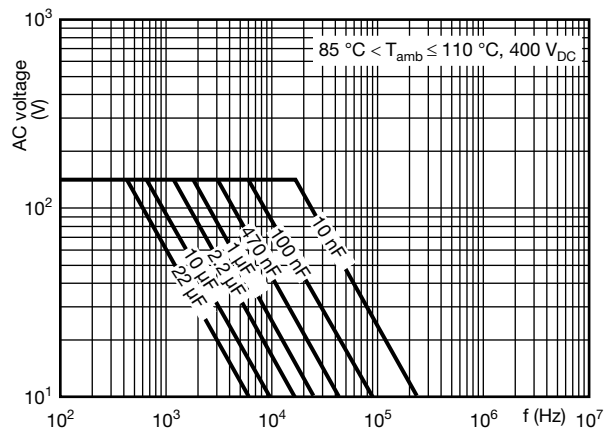

Max. RMS voltage as function of frequency (400 V)

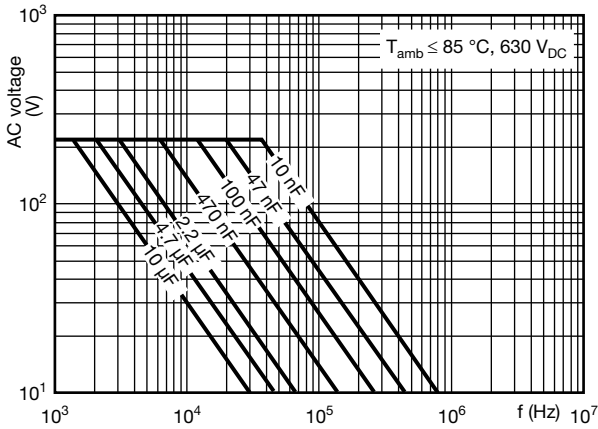

Max. RMS voltage as function of frequency (630 V)

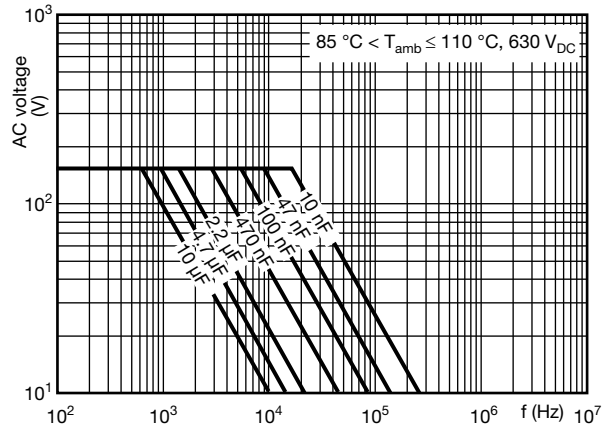

Max. RMS voltage as function of frequency (630 V)

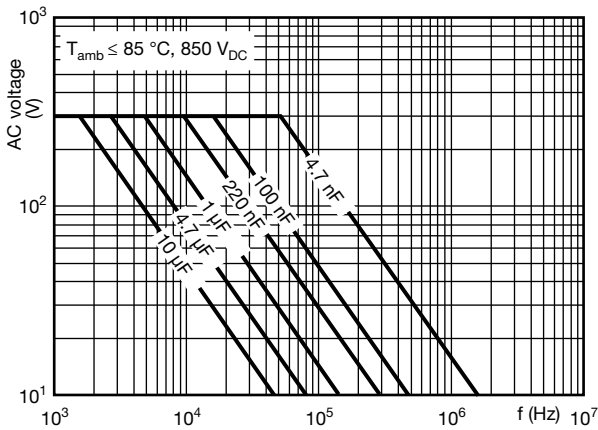

Max RMS voltage as function of frequency (850 V)

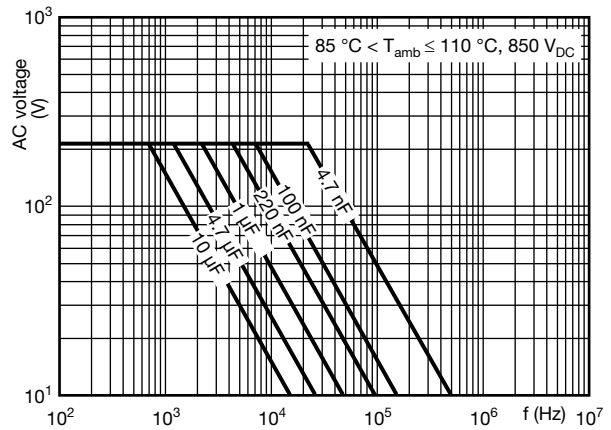

Max. RMS voltage as function of frequency (850 V)

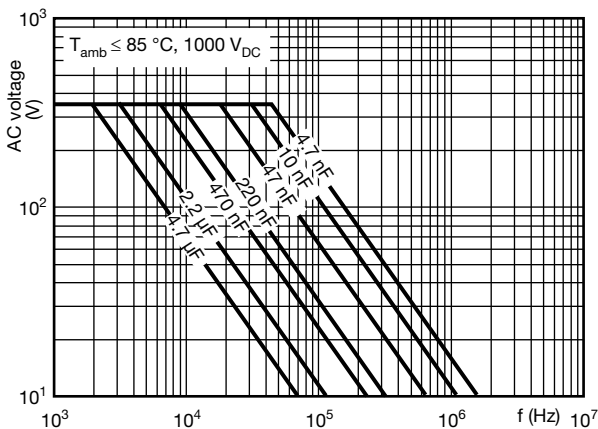

Max. RMS voltage as function of frequency (1000 V)

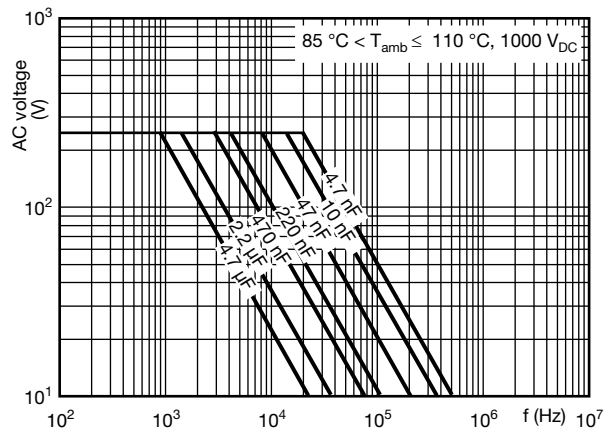

Max. RMS voltage as function of frequency (1000 V)

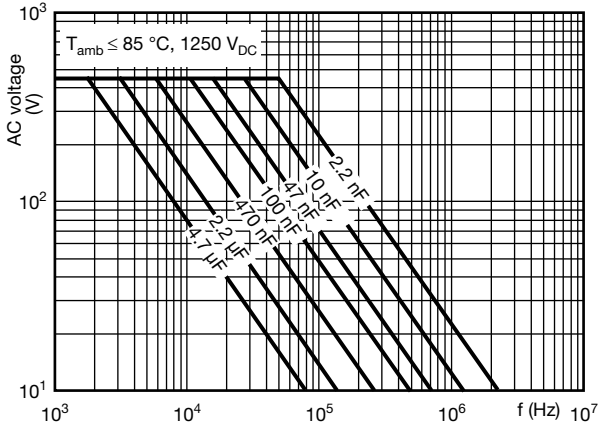

Max. RMS voltage as function of frequency (1250 V)

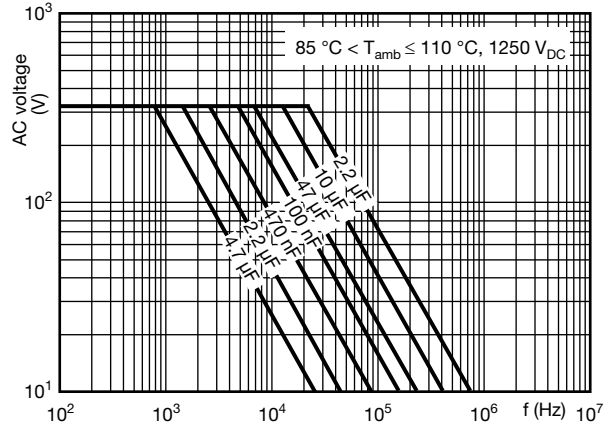

Max. RMS voltage as function of frequency (1250 V)

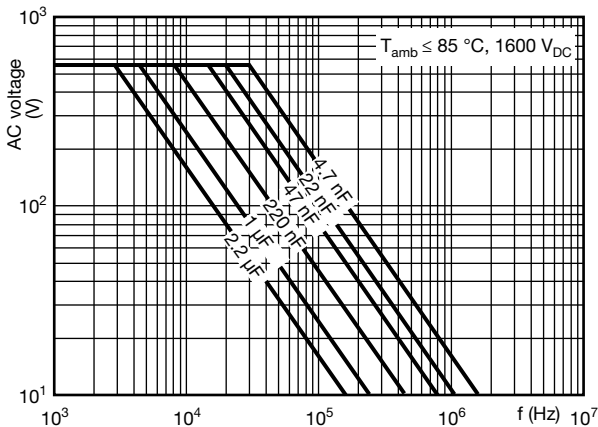

Max. RMS voltage as function of frequency (1600 V)

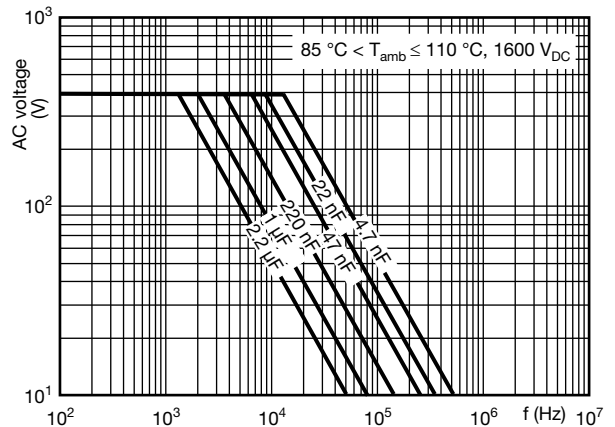

Max. RMS voltage as function of frequency (1600 V)

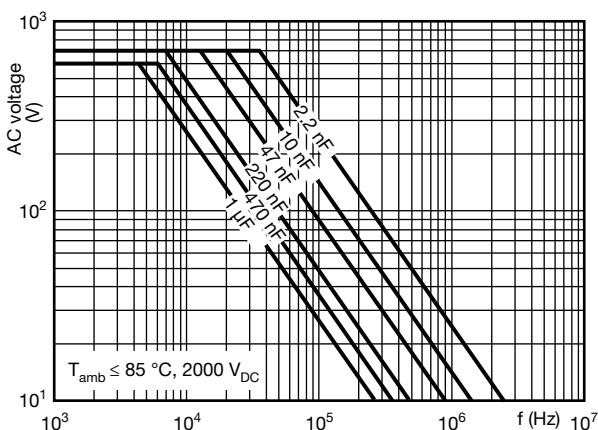

Max. RMS voltage as function of frequency (2000 V)

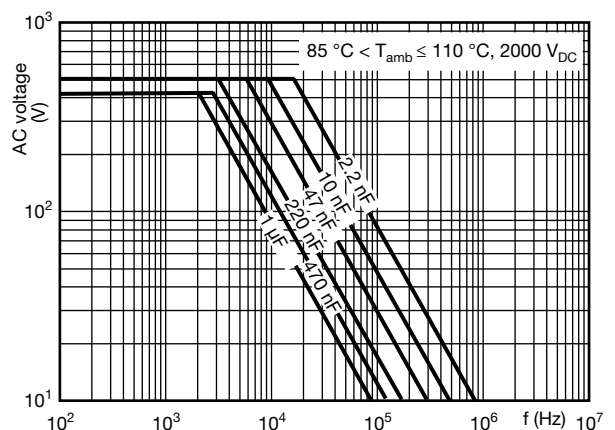

Max. RMS voltage as function of frequency (2000 V)



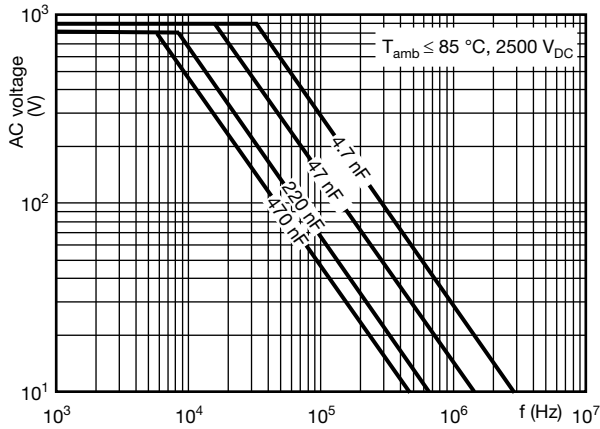

Max. RMS voltage as function of frequency (2500 V)

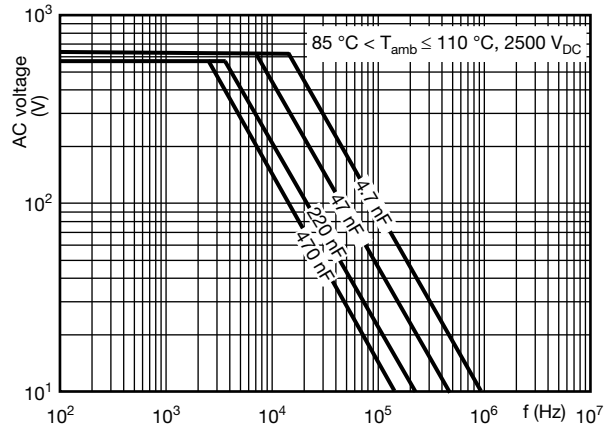

Max. RMS voltage as function of frequency (2500 V)

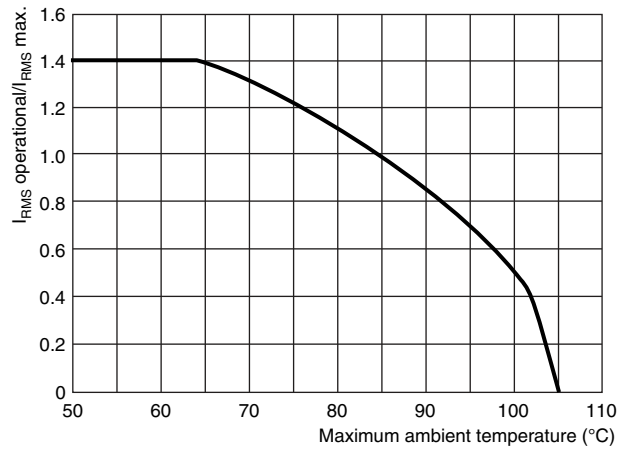

Maximum  $I_{RMS}$  current in function of the ambient temperature

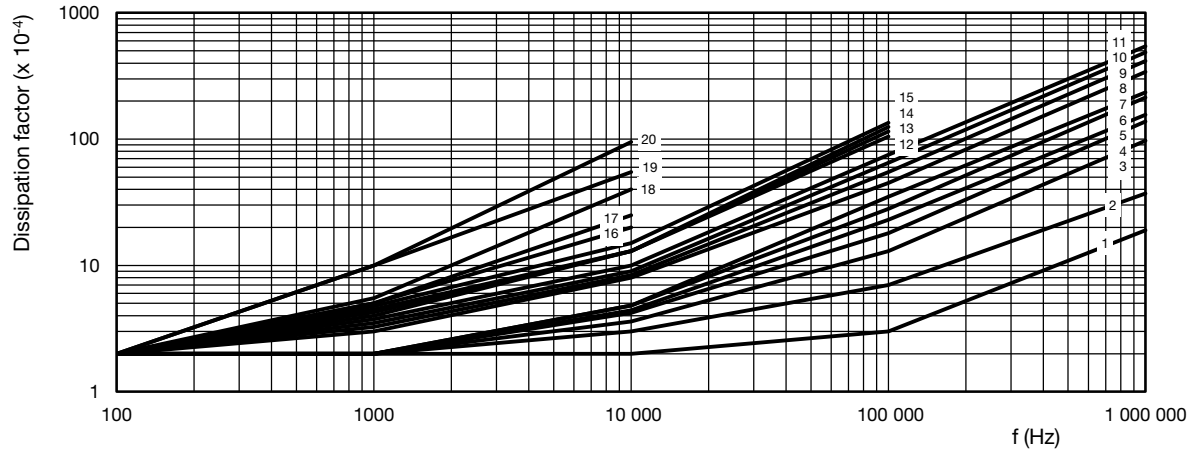

Tangent of loss angle as a function of frequency (typical curve)

<b>160 V:</b> $C \leq 0.018 \mu\text{F}$ , curve 1 $0.018 < C \leq 0.12 \mu\text{F}$ , curve 2 $0.12 < C \leq 0.16 \mu\text{F}$ , curve 5 $0.16 < C \leq 0.33 \mu\text{F}$ , curve 6 $0.33 < C \leq 0.47 \mu\text{F}$ , curve 7 $0.47 < C \leq 0.91 \mu\text{F}$ , curve 10 $0.91 < C \leq 1.1 \mu\text{F}$ , curve 11 $1.1 < C \leq 1.6 \mu\text{F}$ , curve 12 $1.6 < C \leq 2.4 \mu\text{F}$ , curve 13 $2.4 < C \leq 3 \mu\text{F}$ , curve 14 $3 < C \leq 5.6 \mu\text{F}$ , curve 15 $5.6 < C \leq 43 \mu\text{F}$ , curve 18 $43 < C \leq 82 \mu\text{F}$ , curve 20	<b>250 V:</b> $C \leq 0.043 \mu\text{F}$ , curve 2 $0.043 < C \leq 0.091 \mu\text{F}$ , curve 3 $0.091 < C \leq 0.11 \mu\text{F}$ , curve 5 $0.11 < C \leq 0.43 \mu\text{F}$ , curve 6 $0.33 < C \leq 0.47 \mu\text{F}$ , curve 7 $0.43 < C \leq 0.91 \mu\text{F}$ , curve 10 $0.91 < C \leq 3.3 \mu\text{F}$ , curve 12 $3.3 < C \leq 5.6 \mu\text{F}$ , curve 13 $5.6 < C \leq 33 \mu\text{F}$ , curve 18 $33 < C \leq 62 \mu\text{F}$ , curve 20	<b>400 V:</b> $C \leq 0.010 \mu\text{F}$ , curve 1 $0.010 < C \leq 0.036 \mu\text{F}$ , curve 2 $0.036 < C \leq 0.043 \mu\text{F}$ , curve 3 $0.043 < C \leq 0.18 \mu\text{F}$ , curve 4 $0.18 < C \leq 0.43 \mu\text{F}$ , curve 8 $0.43 < C \leq 0.75 \mu\text{F}$ , curve 10 $0.75 < C \leq 3.0 \mu\text{F}$ , curve 11 $3.3 < C \leq 15 \mu\text{F}$ , curve 17 $15 < C \leq 27 \mu\text{F}$ , curve 19	<b>630 V:</b> $C \leq 0.018 \mu\text{F}$ , curve 1 $0.018 < C \leq 0.024 \mu\text{F}$ , curve 2 $0.024 < C \leq 0.043 \mu\text{F}$ , curve 3 $0.043 < C \leq 0.11 \mu\text{F}$ , curve 4 $0.11 < C \leq 0.24 \mu\text{F}$ , curve 7 $0.24 < C \leq 2.4 \mu\text{F}$ , curve 9 $2.4 < C \leq 8.2 \mu\text{F}$ , curve 16 $8.2 < C \leq 15 \mu\text{F}$ , curve 19
<b>850 V:</b> $C \leq 0.0091 \mu\text{F}$ , curve 1 $0.0091 < C \leq 0.051 \mu\text{F}$ , curve 2 $0.051 < C \leq 0.12 \mu\text{F}$ , curve 3 $0.12 < C \leq 0.68 \mu\text{F}$ , curve 4 $0.68 < C \leq 1.3 \mu\text{F}$ , curve 6	<b>1000 V:</b> $C \leq 0.015 \mu\text{F}$ , curve 1 $0.015 < C \leq 0.056 \mu\text{F}$ , curve 2 $0.056 < C \leq 0.10 \mu\text{F}$ , curve 3 $0.1 < C \leq 0.91 \mu\text{F}$ , curve 4	<b>1250 V:</b> $C \leq 0.033 \mu\text{F}$ , curve 1 $0.033 < C \leq 0.091 \mu\text{F}$ , curve 2 $0.091 < C \leq 0.68 \mu\text{F}$ , curve 3	<b>1600 V:</b> $C \leq 0.0091 \mu\text{F}$ , curve 1 $0.0091 < C \leq 0.27 \mu\text{F}$ , curve 2 $0.27 < C \leq 0.36 \mu\text{F}$ , curve 3 $0.36 < C \leq 1 \mu\text{F}$ , curve 5
<b>2000 V:</b> $C \leq 0.018 \mu\text{F}$ , curve 1 $0.018 < C \leq 0.22 \mu\text{F}$ , curve 2 $0.22 < C \leq 1 \mu\text{F}$ , curve 4	<b>2500 V:</b> $C \leq 0.082 \mu\text{F}$ , curve 1 $0.082 < C \leq 0.39 \mu\text{F}$ , curve 2 $0.39 < C \leq 0.68 \mu\text{F}$ , curve 4		

<b>HEAT CONDUCTIVITY (G) AS A FUNCTION OF (ORIGINAL) PITCH AND CAPACITOR BODY THICKNESS IN mW/°C</b>								
$W_{max}$ (mm)	HEAT CONDUCTIVITY (mW/°C)							
	PITCH 5 mm	PITCH 7.5 mm	PITCH 10 mm	PITCH 15 mm	PITCH 22.5 mm	PITCH 27.5 mm	PITCH 37.5 mm	PITCH 52.5 mm
3	-	4	-	-	-	-	-	-
3.5	3	-	-	-	-	-	-	-
4	-	5	6.5	-	-	-	-	-
4.5	4	-	-	-	-	-	-	-
5	-	6	7.5	10	-	-	-	-
6	5.5	7	9	11	19	-	-	-
7	-	-	-	12	21	-	-	-
8.5	-	-	-	16	25	-	-	-
9	-	-	-	-	-	31	-	-
10	-	-	-	18	28	-	-	-
11	-	-	-	-	-	36	-	-
12	-	-	-	-	34	-	-	-
13	-	-	-	-	-	42	-	-
14.5	-	-	-	-	-	-	-	-
15	-	-	-	-	-	48	-	-
18	-	-	-	-	-	57	-	-
18.5	-	-	-	-	-	-	89	-
21	-	-	-	-	-	68	-	-
21.5	-	-	-	-	-	-	102	-
24	-	-	-	-	-	-	116	-
25	-	-	-	-	-	-	-	152
30	-	-	-	-	-	-	134	181
35	-	-	-	-	-	-	-	197

### POWER DISSIPATION AND MAXIMUM COMPONENT TEMPERATURE RISE

The power dissipation must be limited in order not to exceed the maximum allowed component temperature rise as a function of the free air ambient temperature.

The power dissipation can be calculated according type detail specification “HQN-384-01/101: Technical information film capacitors with the typical tgδ of the curves.”.

The component temperature rise ( $\Delta T$ ) can be measured (see section “Measuring the component temperature” for more details) or calculated by  $\Delta T = P/G$ :

- $\Delta T$  = component temperature rise (°C)
- P = power dissipation of the component (mW)
- G = heat conductivity of the component (mW/°C)

### MEASURING THE COMPONENT TEMPERATURE

A thermocouple must be attached to the capacitor body as in:

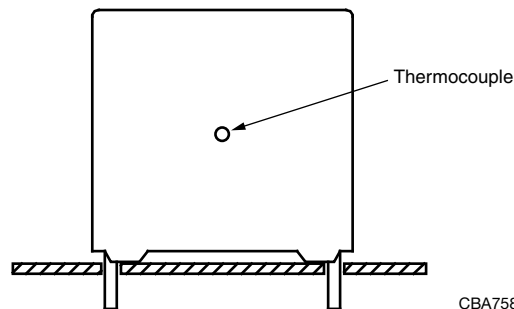

The temperature is measured in unloaded ( $T_{amb}$ ) and maximum loaded condition ( $T_C$ ).

The temperature rise is given by  $\Delta T = T_C - T_{amb}$ .

To avoid radiation or convection, the capacitor should be tested in a wind-free box.

**APPLICATION NOTE AND LIMITING CONDITIONS**

For capacitors connected in parallel, normally the proof voltage and possibly the rated voltage must be reduced. For information depending of the capacitance value and the number of parallel connections contact: [dc-film@vishay.com](mailto:dc-film@vishay.com)

These capacitors are not suitable for mains applications as across-the-line capacitors without additional protection, as described hereunder. These mains applications are strictly regulated in safety standards and therefore electromagnetic interference suppression capacitors conforming the standards must be used.

To select the capacitor for a certain application, the following conditions must be checked:

1. The peak voltage ( $U_p$ ) shall not be greater than the rated DC voltage ( $U_{RDC}$ )
2. The peak-to-peak voltage ( $U_{p-p}$ ) shall not be greater than the maximum ( $U_{p-p}$ ) to avoid the ionization inception level
3. The voltage peak slope ( $dU/dt$ ) shall not exceed the rated voltage pulse slope in an RC-circuit at rated voltage and without ringing. If the pulse voltage is lower than the rated DC voltage, the rated voltage pulse slope may be multiplied by  $U_{RDC}$  and divided by the applied voltage.

For all other pulses following equation must be fulfilled:

$$2 \times \int_0^T \left( \frac{dU}{dt} \right)^2 \times dt < U_{RDC} \times \left( \frac{dU}{dt} \right)_{\text{rated}}$$

T is the pulse duration

4. The maximum component surface temperature rise must be lower than the limits (see graph "Max. allowed component temperature rise").
5. Since in circuits used at voltages over 280 V peak-to-peak the risk for an intrinsically active flammability after a capacitor breakdown (short circuit) increases, it is recommended that the power to the component is limited to 100 times the values mentioned in the table: "Heat Conductivity"
6. When using these capacitors as across-the-line capacitor in the input filter for mains applications or as series connected with an impedance to the mains the applicant must guarantee that the following conditions are fulfilled in any case (spikes and surge voltages from the mains included).

<b>VOLTAGE CONDITIONS FOR 6 ABOVE</b>			
<b>ALLOWED VOLTAGES</b>	<b><math>T_{\text{amb}} \leq 85^\circ\text{C}</math></b>	<b><math>85^\circ\text{C} &lt; T_{\text{amb}} \leq 110^\circ\text{C}</math></b>	<b><math>110^\circ\text{C} &lt; T_{\text{amb}} \leq 125^\circ\text{C}</math></b>
Maximum continuous RMS voltage	$U_{RAC}$	$0.7 \times U_{RAC}$	$0.5 \times U_{RAC}$
Maximum temporary RMS-over voltage (< 24 h)	$1.25 \times U_{RAC}$	$0.875 \times U_{RAC}$	$0.625 \times U_{RAC}$
Maximum peak voltage ( $V_{o-p}$ ) (< 2 s)	$1.6 \times U_{RDC}$	$1.1 \times U_{RDC}$	$0.8 \times U_{RDC}$

**EXAMPLE**

$C = 4n7 - 1600\text{ V}$  used for the voltage signal shown in next drawing.

$U_{p-p} = 1000\text{ V}$ ;  $U_p = 900\text{ V}$ ;  $T_1 = 12\ \mu\text{s}$ ;  $T_2 = 64\ \mu\text{s}$ ;  $T_3 = 4\ \mu\text{s}$

The ambient temperature is  $80^\circ\text{C}$ . In case of failure, the oscillation is blocked.

Checking the conditions:

1. The peak voltage  $U_p = 900\text{ V}$  is lower than  $1600\text{ V}_{DC}$
2. The peak-to-peak voltage  $1000\text{ V}$  is lower than  $2\sqrt{2} \times 550\text{ V}_{AC} = 1600\text{ V}_{p-p}$
3. The voltage pulse slope ( $dU/dt$ ) =  $1000\text{ V}/4\ \mu\text{s} = 250\text{ V}/\mu\text{s}$   
This is lower than  $4000\text{ V}/\mu\text{s}$  (see specific reference data for each version)
4. The dissipated power is  $35\text{ mW}$  as calculated with fourier terms and typical  $tg\delta$ .  
The temperature rise for  $W_{\text{max.}} = 6\text{ mm}$  and pitch =  $15\text{ mm}$  will be  $35\text{ mW}/9\text{ mW}/^\circ\text{C} = 3.9^\circ\text{C}$   
This is lower than  $10^\circ\text{C}$  temperature rise at  $80^\circ\text{C}$ , according graph.
5. Oscillation is blocked
6. Not applicable

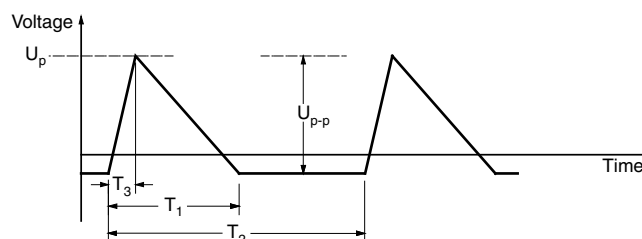
**VOLTAGE SIGNAL**



INSPECTION REQUIREMENTS

General Notes

Sub-clause numbers of tests and performance requirements refer to the "Sectional Specification, Publication IEC 60384-17 and Specific Reference Data".

GROUP C INSPECTION REQUIREMENTS		
SUB-CLAUSE NUMBER AND TEST	CONDITIONS	PERFORMANCE REQUIREMENTS
<b>SUB-GROUP C1A PART OF SAMPLE OF SUB-GROUP C1</b>		
4.1 Dimensions (detail)		As specified in Chapters "General data" of this specification
4.3.1 Initial measurements	Capacitance Tangent of loss angle: $C \leq 1 \mu\text{F}$ at 100 kHz $1 \mu\text{F} < C \leq 10 \mu\text{F}$ at 10 kHz $C > 10 \mu\text{F}$ at 1 kHz	
4.3 Robustness of terminations	Tensile: load 10 N; 10 s Bending: load 5 N; 4 x 90°	No visible damage
4.4 Resistance to soldering heat	Method: 1 A Solder bath: 280 °C ± 5 °C Duration: 10 s	
4.14 Component solvent resistance	Isopropylalcohol at room temperature Method: 2 Immersion time: 5 min ± 0.5 min Recovery time: min. 1 h, max. 2 h	
4.4.2 Final measurements	Visual examination  Capacitance  Tangent of loss angle	No visible damage Legible marking  $I\Delta C/CI \leq 1\%$ of the value measured initially.  Increase of tan $\delta$ : $\leq 0.0005$ for: $C \leq 100 \text{ nF}$ at 100 kHz $\leq 0.0010$ for: $100 \text{ nF} < C \leq 470 \text{ nF}$ at 100 kHz $\leq 0.0015$ for: $470 \text{ nF} < C \leq 1 \mu\text{F}$ at 100 kHz $\leq 0.0015$ for: $1 \mu\text{F} < C \leq 10 \mu\text{F}$ at 10 kHz $\leq 0.0015$ for: $C > 10 \mu\text{F}$ at 1 kHz Compared to values measured in 4.3.1
4.6.1 Initial measurements	Capacitance Tangent of loss angle: $C \leq 1 \mu\text{F}$ at 100 kHz $1 \mu\text{F} < C \leq 10 \mu\text{F}$ at 10 kHz $C > 10 \mu\text{F}$ at 1 kHz	
4.15 Solvent resistance of the marking	Isopropylalcohol at room temperature Method: 1 Rubbing material: cotton wool Immersion time: 5 min ± 0.5 min	No visible damage Legible marking
4.6 Rapid change of temperature	$\theta A = -55 \text{ }^\circ\text{C}$ $\theta B = +110 \text{ }^\circ\text{C}$ 5 cycles Duration t = 30 min	



GROUP C INSPECTION REQUIREMENTS		
SUB-CLAUSE NUMBER AND TEST	CONDITIONS	PERFORMANCE REQUIREMENTS
<b>SUB-GROUP C1A PART OF SAMPLE OF SUB-GROUP C1</b>		
4.7. Vibration	Visual examination Mounting: see section "Mounting" for more information Procedure B4 Frequency range: 10 Hz to 55 Hz. Amplitude: 0.75 mm or Acceleration 98 m/s <sup>2</sup> (whichever is less severe) Total duration 6 h.	No visible damage
4.7.2 Final inspection	Visual examination	
4.9 Shock	Mounting: see section "Mounting" for more information Pulse shape: half sine Acceleration: 490 m/s <sup>2</sup> Duration of pulse: 11 ms	
4.9.3 Final measurements	Visual examination  Capacitance  Tangent of loss angle    Insulation resistance	No visible damage  IΔC/CI ≤ 2 % of the value measured in 4.6.1.  Increase of tan δ: ≤ 0.0005 for: C ≤ 100 nF at 100 kHz ≤ 0.0010 for: 100 nF < C ≤ 470 nF at 100 kHz ≤ 0.0015 for: 470 nF < C ≤ 1 μF at 100 kHz ≤ 0.0015 for: 1 μF < C ≤ 10 μF at 10 kHz ≤ 0.0015 for: C > 10 μF at 1 kHz Compared to values measured in 4.6.1  As specified in section "Insulation Resistance" of this specification.
<b>SUB-GROUP C1 COMBINED SAMPLE OF SPECIMENS OF SUB-GROUPS C1A AND C1B</b>		
4.10 Climatic sequence		
4.10.2 Dry heat	Temperature +110 °C Duration: 16 h	
4.10.3 Damp heat cyclic Test Db, first cycle		
4.10.4 Cold	Temperature: -55 °C Duration: 2 h	
4.10.6 Damp heat cyclic Test Db remaining cycles		
4.10.6.2 Final measurements	Voltage proof = U <sub>RDC</sub> for 1 min within 15 min after removal from test chamber  Visual examination  Capacitance  Tangent of loss angle   Insulation resistance	No breakdown or flashover  No visible damage Legible marking  IΔC/CI ≤ 2 % of the value measured in 4.4.2 or 4.9.3  Increase of tan δ: ≤ 0.0005 for: C ≤ 100 nF at 100 kHz ≤ 0.0010 for: 100 nF < C ≤ 470 nF at 100 kHz ≤ 0.0015 for: 470 nF < C ≤ 1 μF at 100 kHz ≤ 0.0015 for: 1 μF < C ≤ 10 μF at 10 kHz ≤ 0.0015 for: C > 10 μF at 1 kHz Compared to values measured in 4.3.1 or 4.6.1  ≥ 50 % of values specified in section "Insulation Resistance" of this specification.



GROUP C INSPECTION REQUIREMENTS		
SUB-CLAUSE NUMBER AND TEST	CONDITIONS	PERFORMANCE REQUIREMENTS
<b>SUB-GROUP C2</b>		
4.11 Damp heat steady state	56 days; 40 °C; 90 % to 95 % RH no load	
4.11.1 Initial measurements	Capacitance Tangent of loss angle at 1 kHz	
4.11.3 Final measurements	Voltage proof = $U_{RDC}$ for 1 min within 15 min after removal from test chamber	No breakdown or flashover
	Visual examination	No visible damage Legible marking
	Capacitance	$I\Delta C/CI \leq 2\%$ of the value measured in 4.11.1.
	Tangent of loss angle	Increase of $\tan \delta$ $\leq 0.0005$ for: $C \leq 100$ nF at 100 kHz $\leq 0.0010$ for: $100$ nF < $C \leq 470$ nF at 100 kHz $\leq 0.0015$ for: $470$ nF < $C \leq 1$ $\mu$ F at 100 kHz $\leq 0.0015$ for: $1$ $\mu$ F < $C \leq 10$ $\mu$ F at 10 kHz $\leq 0.0015$ for: $C > 10$ $\mu$ F at 1 kHz Compared to values measured in 4.11.1.
	Insulation resistance	$\geq 50\%$ of values specified in section "Insulation resistance" of this specification
<b>SUB-GROUP C3A</b>		
4.12.1 Endurance	Duration: 2000 h Temperature: 85 °C Voltage: $1.25 \times U_{RAC} V_{RMS}$ , 50 Hz or Duration: 2000 h Temperature: 110 °C Voltage: $0.875 \times U_{RAC} V_{RMS}$ , 50 Hz	
4.12.1.1 Initial measurements	Capacitance Tangent of loss angle $C \leq 1$ $\mu$ F at 100 kHz $1$ $\mu$ F < $C \leq 10$ $\mu$ F at 10 kHz $C > 10$ $\mu$ F at 1 kHz	
4.12.1.3 Final measurements	Visual examination	No visible damage Legible marking
	Capacitance	$I\Delta C/CI \leq 5\%$ for $C > 10$ nF $I\Delta C/CI \leq 8\%$ for $C \leq 10$ nF Compared to values measured in 4.12.1.1
	Tangent of loss angle	Increase of $\tan \delta$ : $\leq 0.0005$ for: $C \leq 100$ nF at 100 kHz $\leq 0.0010$ for: $100$ nF < $C \leq 470$ nF at 100 kHz $\leq 0.0015$ for: $470$ nF < $C \leq 1$ $\mu$ F at 100 kHz $\leq 0.0015$ for: $1$ $\mu$ F < $C \leq 10$ $\mu$ F at 10 kHz $\leq 0.0015$ for: $C > 10$ $\mu$ F at 1 kHz Compared to values measured in 4.12.1.1
	Insulation resistance	$\geq 50\%$ of values specified in section "Insulation resistance" of this specification.



GROUP C INSPECTION REQUIREMENTS		
SUB-CLAUSE NUMBER AND TEST	CONDITIONS	PERFORMANCE REQUIREMENTS
<b>SUB-GROUP C3B</b>		
4.12.2 Endurance test at 50 Hz alternating voltage	Duration: 500 h Voltage: 1.25 x U <sub>RDC</sub> 110 °C	
4.12.2.1 Initial measurements	0.625 x U <sub>RAC</sub> at 125 °C Capacitance Tangent of loss angle: C ≤ 1 μF at 100 kHz 1 μF < C ≤ 10 μF at 10 kHz C > 10 μF at 1 kHz	
4.12.2.3 Final measurements	Visual examination  Capacitance  Tangent of loss angle   Insulation resistance	No visible damage Legible marking  IΔC/CI ≤ 10 % + 100 pF compared to values measured in 4.12.2.1  Increase of tan δ: ≤ 0.0005 for: C ≤ 100 nF at 100 kHz ≤ 0.0010 for: 100 nF < C ≤ 470 nF at 100 kHz ≤ 0.0015 for: 470 nF < C ≤ 1 μF at 100 kHz ≤ 0.0015 for: 1 μF < C ≤ 10 μF at 10 kHz ≤ 0.0015 for: C > 10 μF at 1 kHz Compared to values measured in 4.12.2.1  ≥ 50 % of values specified in section "Insulation Resistance" of this specification.
<b>SUB-GROUP C4</b>		
4.2.6 Temperature characteristics Initial measurements Intermediate measurements	Capacitance Capacitance at -55 °C Capacitance at 20 °C Capacitance at +125 °C	For -55 °C to +20 °C: +1 % ≤ IΔC/CI ≤ 3.75 % or for 20 °C to 105 °C: -7.5 % ≤ IΔC/CI ≤ 0 %
Final measurements	Capacitance  Insulation resistance	As specified in section "Capacitance" of this specification  As specified in section "Insulation Resistance" of this specification
4.13 Charge and discharge	10 000 cycles Charged to U <sub>RDC</sub> discharge resistance: $R = \frac{U_{RDC}}{2.5 \times C (dU/dt)}$	
4.13.1 Initial measurements	Capacitance Tangent of loss angle: C ≤ 1 μF at 100 kHz 1 μF < C ≤ 10 μF at 10 kHz C > 10 μF at 1 kHz	
4.13.3 Final measurements	Capacitance  Tangent of loss angle  Insulation resistance	IΔC/CI ≤ 1 % compared to values measured in 4.13.1.  Increase of tan δ: ≤ 0.0005 for: C ≤ 100 nF or ≤ 0.001 for: 100 nF < C ≤ 470 nF or ≤ 0.0015 for: C > 470 nF Compared to values measured in 4.13.1  ≥ 50 % of values specified in section "Insulation Resistance" of this specification.





GROUP C INSPECTION REQUIREMENTS		
SUB-CLAUSE NUMBER AND TEST	CONDITIONS	PERFORMANCE REQUIREMENTS
<b>SUB-GROUP ADD1</b>		
A.1 Ignition of lamp test Only for 1600 V and 2000 V series (Cap. value < 33 nF)	Capacitance	
A.1.1 Initial measurements	Tangent of loss angle at 100 kHz Temperature: 85 °C	
A.1.2 Ignition of lamp test	10 000 cycles: 1 s ON 29 s OFF: Frequency: 60 kHz Voltage: 1600 V type: 2800 V <sub>pp</sub> 2000 V type: 3000 V <sub>pp</sub>	
A.1.3 Final measurements	Visual examination	No visible damage
	Capacitance	$ \Delta C/C  \leq 5\%$ of the value measured in A.1.1
	Tangent of loss angle	Increase of tan $\delta$ : $\leq 0.0005$ for: $C \leq 100$ nF at 100 kHz $\leq 0.0010$ for: $100$ nF < $C \leq 470$ nF at 100 kHz $\leq 0.0015$ for: $470$ nF < $C \leq 1$ $\mu$ F at 100 kHz $\leq 0.0015$ for: $1$ $\mu$ F < $C \leq 10$ $\mu$ F at 10 kHz $\leq 0.0015$ for: $C > 10$ $\mu$ F at 1 kHz Compared to values measured in A.1.1
	Insulation resistance	$\geq 50\%$ of values specified in section "Insulation Resistance" of this specification



## Disclaimer

ALL PRODUCT, PRODUCT SPECIFICATIONS AND DATA ARE SUBJECT TO CHANGE WITHOUT NOTICE TO IMPROVE RELIABILITY, FUNCTION OR DESIGN OR OTHERWISE.

Vishay Intertechnology, Inc., its affiliates, agents, and employees, and all persons acting on its or their behalf (collectively, "Vishay"), disclaim any and all liability for any errors, inaccuracies or incompleteness contained in any datasheet or in any other disclosure relating to any product.

Vishay makes no warranty, representation or guarantee regarding the suitability of the products for any particular purpose or the continuing production of any product. To the maximum extent permitted by applicable law, Vishay disclaims (i) any and all liability arising out of the application or use of any product, (ii) any and all liability, including without limitation special, consequential or incidental damages, and (iii) any and all implied warranties, including warranties of fitness for particular purpose, non-infringement and merchantability.

Statements regarding the suitability of products for certain types of applications are based on Vishay's knowledge of typical requirements that are often placed on Vishay products in generic applications. Such statements are not binding statements about the suitability of products for a particular application. It is the customer's responsibility to validate that a particular product with the properties described in the product specification is suitable for use in a particular application. Parameters provided in datasheets and / or specifications may vary in different applications and performance may vary over time. All operating parameters, including typical parameters, must be validated for each customer application by the customer's technical experts. Product specifications do not expand or otherwise modify Vishay's terms and conditions of purchase, including but not limited to the warranty expressed therein.

Hyperlinks included in this datasheet may direct users to third-party websites. These links are provided as a convenience and for informational purposes only. Inclusion of these hyperlinks does not constitute an endorsement or an approval by Vishay of any of the products, services or opinions of the corporation, organization or individual associated with the third-party website. Vishay disclaims any and all liability and bears no responsibility for the accuracy, legality or content of the third-party website or for that of subsequent links.

Except as expressly indicated in writing, Vishay products are not designed for use in medical, life-saving, or life-sustaining applications or for any other application in which the failure of the Vishay product could result in personal injury or death. Customers using or selling Vishay products not expressly indicated for use in such applications do so at their own risk. Please contact authorized Vishay personnel to obtain written terms and conditions regarding products designed for such applications.

No license, express or implied, by estoppel or otherwise, to any intellectual property rights is granted by this document or by any conduct of Vishay. Product names and markings noted herein may be trademarks of their respective owners.