

500 Watts

- Convection/Forced-cooled Ratings
- Universal 80 - 264VAC Input
- IT & Medical Safety Approvals
- <1W Standby Power
- -40 °C to +70 °C Operation
- Remote On/Off
- 5V/2A Standby Output
- 3 Year Warranty



The GSP500 has been designed to offer a full 500W of output power in a very small mechanical footprint, whilst still providing peak power to 650W, a 5V standby output with 2Amps of current capability and an input standby power draw of <1W when the inhibit is activated.

Approved for both IT and medical applications the series has output versions from 12V to 48V and can be supplied as a U channel for system cooling or with optional very quiet integral fans (-EF). These fans are intelligently controlled to provide the most optimised acoustic noise in the system and further more the GSP500 can provide up to 180W without forced cooling, thus allowing fans to be switched off during periods of lower system loading.

Dimensions:

GSP:
 6.00 x 4.00 x 1.65" (152.4 x 101.6 x 41.9 mm)
 (-EF): 6.71 x 4.00 x 1.65" (170.4 x 101.6 x 41.9 mm)

Models & Ratings

Output Voltage	Output Current V1		Standby Supply		Fan Supply	Max Output Power		Model Number ⁽¹⁻³⁾
	Convection	Forced	Convection	Forced		Nom	Peak ⁽²⁾	
12.0 VDC	15.00 A	42.0 A	5 V/1 A	5 V/2 A	12 V/0.3 A	500 W	650 W	GSP500PS12-EF
24.0 VDC	7.50 A	21.0 A	5 V/1 A	5 V/2 A	12 V/0.3 A	500 W	650 W	GSP500PS24-EF
48.0 VDC	3.75 A	10.5 A	5 V/1 A	5 V/2 A	12 V/0.3 A	500 W	650 W	GSP500PS48-EF

Notes

1. Remove suffix -EF (EndFan) for use with integral system cooling.
2. Peak power available for 100 ms maximum with a 10% duty cycle. The average power in a period should be equal or less than the normal power.
3. For optional current share version, add suffix 'P', e.g. GSP500PS24P or GSP500PS24P-EF.

Mechanical Details

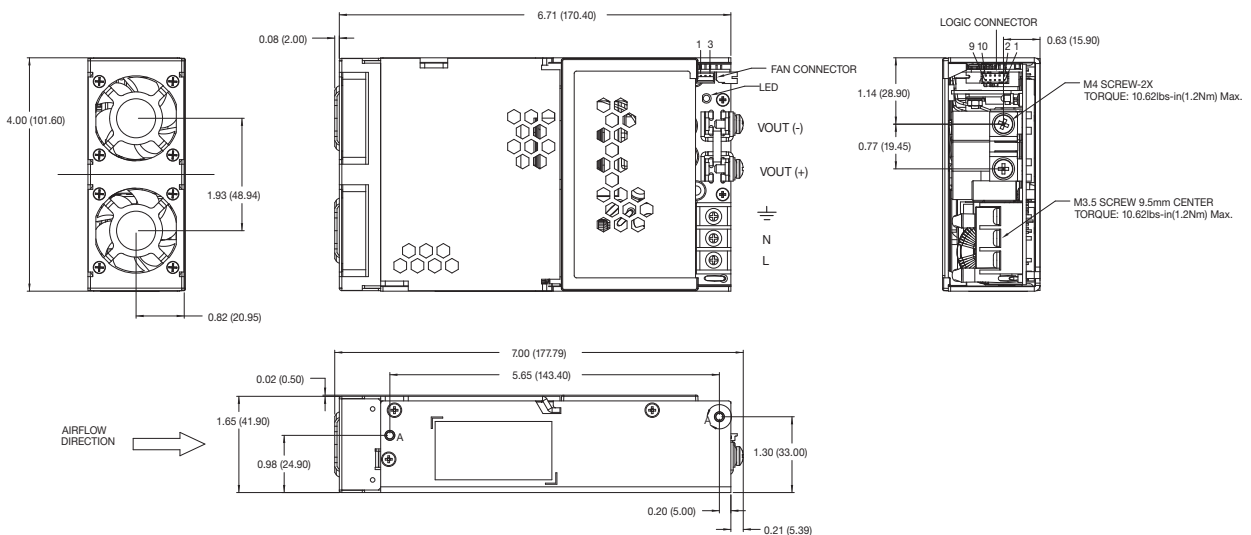

Input

Characteristic	Minimum	Typical	Maximum	Units	Notes & Conditions
Input Voltage - Operating	80	115/230	264	VAC	Derate output power <90 VAC. See fig 1.
Input Voltage - Fault condition			300	VAC	5 second max
Input Frequency	47	50/60	63	Hz	
Power Factor		>0.9			230 VAC, 100% load
Input Current - Full Load		5.0/2.4		A	115/230 VAC
Inrush Current		60		A	
No Load Input Power			0.5	W	All models, when inhibit activated
			3.0		GSP500PS12 - 115 VAC
			1.3		GSP500PS12 - 230 VAC
			3.0		GSP500PS24 - 115 VAC
			1.2		GSP500PS24 - 230 VAC
			4.8		GSP500PS48 - 115 VAC
		2.3	GSP500PS48 - 230 VAC		
Earth Leakage Current		80/220	250	μA	115/230 VAC/50 Hz Typ., 264 VAC/60 Hz Max.
Input Protection	F16 A/250 V internal fuse in both lines				

Output

Characteristic	Minimum	Typical	Maximum	Units	Notes & Conditions
Output Voltage - V1	12		48	VDC	See Models and Ratings table
Initial Set Accuracy			±1	%	50% load, 115/230 VAC
Output Voltage Adjustment			+1,-3	%	
Minimum Load	0			A	
Start Up Delay		0.5	2	s	115/230 VAC full load from input AC turn on
Hold Up Time	20			ms	
Drift			±0.2	%	After 20 min warm up
Line Regulation		0.01	0.5	%	90-264 VAC
Load Regulation		0.2	1.0	%	0-100% load
Transient Response			4	%	Recovery within 1% in less than 500 μs for a 50-75% and 75-50% load step
Over/Undershoot		0		%	
Ripple & Noise		0.5	1.5	% pk-pk	20 MHz bandwidth
Overvoltage Protection	115		140	%	Vnom DC. Output 1, recycle input to reset
Overload Protection	110		150	% I nom	See fig. 2. Trip and Restart
Short Circuit Protection					Shutdown & auto recovery
Temperature Coefficient			0.05	%/°C	
Overtemperature Protection					Shutdown & auto recovery

Input Voltage Derating Curve

Figure 1

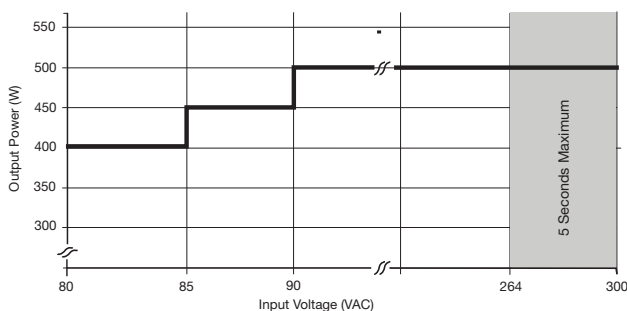

Output Overload Characteristic

Figure 2
GSP500PS12 example (others similar).

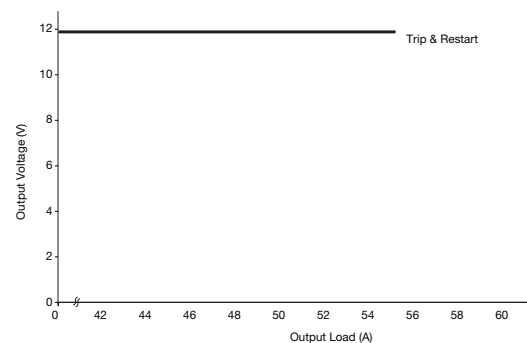

General

Characteristic	Minimum	Typical	Maximum	Units	Notes & Conditions
Efficiency		90		%	230 VAC Full load (see fig.3-5)
Isolation: Input to Output Input to Ground Output to Ground	4000			VAC	2 x MOPP
	1500			VAC	1 x MOPP
	500			VDC	
Switching Frequency		65		kHz	PFC Converter
	50	90	200		Main Converter
		100			Standby Converter
Power Density			12.6	W/in ³	
Mean Time Between Failure		216		kHrs	MIL-HDBK-217F, Notice 2 +25 °C GB
Weight		1.87 (0.85)		lb (kg)	GSP500PSxx models
		1.98 (0.90)			GSP500PSxx-EF models

Efficiency Vs Load

Figure 3
12 V Models

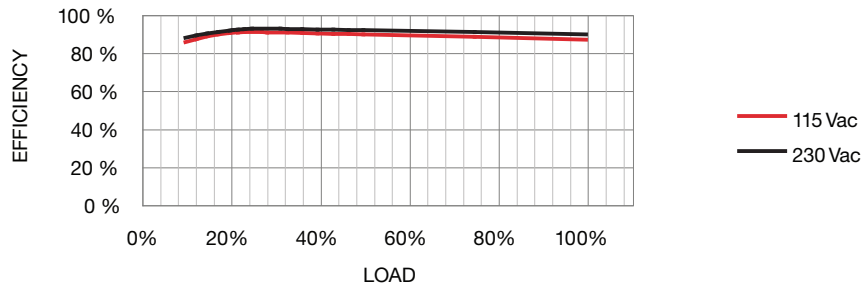

Figure 4
24 V Models

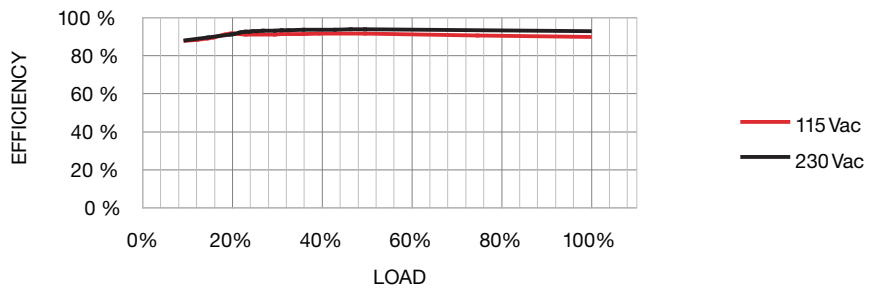
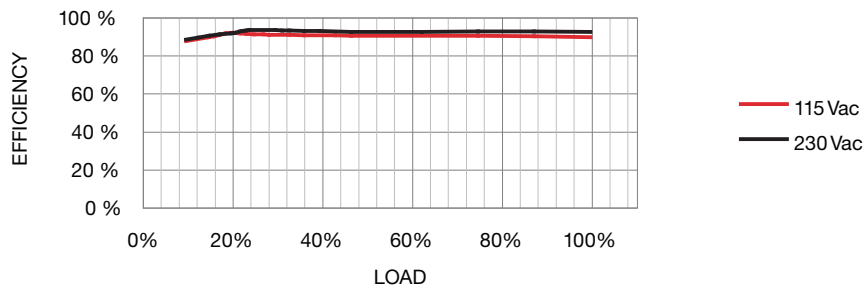

Figure 5
48 V Models



Signals & Controls

Characteristic	Notes & Conditions
Power Fail (PF)	Open collector referenced to negative sense, transistor normally on when power is good (see fig. 5); power is considered good when PFC bulk capacitor voltage is normal. PF: Provides ≥ 5 ms warning of loss of output from power failure.
Inhibit	Uncommitted isolated optocoupler diode, powered diode inhibits both V1 and fan supply (see fig. 6). During inhibit the standby supply and current should be limited to 1 A for thermal reasons.
Output Good	LED Indicator
Fan Speed Control GSP500PSxx-EF Models	The fan speed is set to one of 4 states (high, mid, low or off) dependant on the internal power supply ambient temperature, input voltage and output load at any given time.
Standby Supply	5V/2A Isolated supply present when AC applied.
Remote Sense	Compensates for 0.5 V total voltage drop.
Current Share	Optional, on 'P' version only. Connecting pins 5 or 6 on one unit to pins 5 or 6 on another like voltage unit will force the current to be shared within 10% between the two outputs. Up to three units can share current. (see fig. 7)

Power Fail (PF)

Figure 5

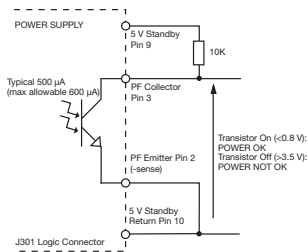

Remote On/Off (Inhibit)

Figure 6

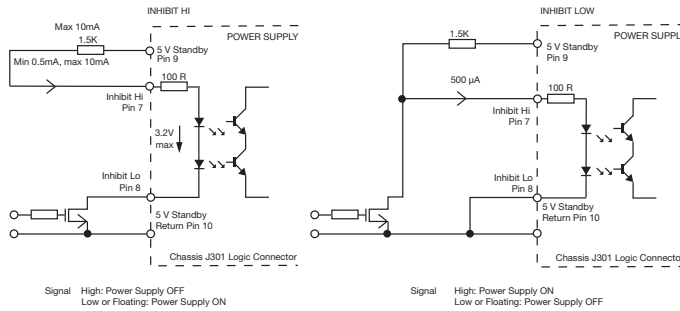

Current Share

Figure 7

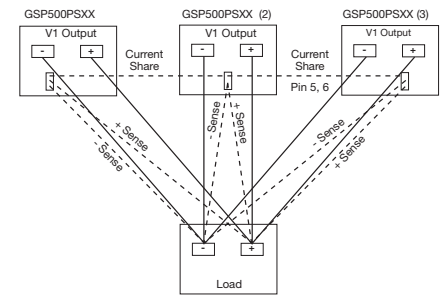

Environmental

Characteristic	Minimum	Typical	Maximum	Units	Notes & Conditions
Operating Temperature	-20		+70	°C	Start up at -40 °C. See derating curve, fig. 8
Storage Temperature	-40		+85	°C	
Cooling	12			CFM	GSP500PSxx models
Humidity	5		95	%RH	Non-condensing
Operating Altitude			5000	m	
Acoustic Fan Noise GSP500PSxx-EF Models		59.9		Lw db(A)	Full Speed
		52.2		Lw db(A)	Mid Speed
		36.6		Lw db(A)	Low Speed
Shock					$\pm 3 \times 30g$ shocks in each plane, total 18 shocks. 30g = 11ms (+/-0.5msec), half sine. Conforms to EN60068-2-27 & EN60068-2-47
Vibration					Single axis 10 - 500 Hz at 2g sweep and endurance at resonance in all 3 planes. Conforms to EN60068-2-6

Thermal Derating Curve

Figure 8

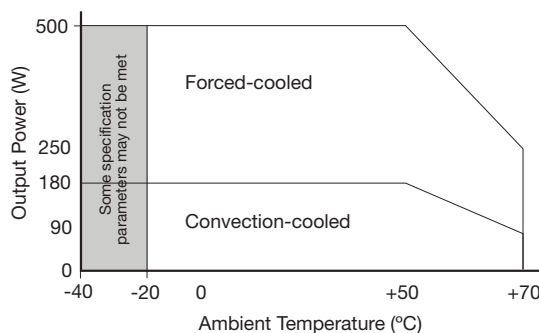

EMC: Emissions

Phenomenon	Standard	Test Level	Notes & Conditions
Conducted	EN55011/32	Class B	
Radiated	EN55011/32	Class A	
		Class B	With 1 Turn Würth 742 712 22 core or similar on output lead
Harmonic Fluctuations	EN61000-3-3		

EMC: Immunity

Phenomenon	Standard	Test Level	Criteria	Notes & Conditions	
Low Voltage PSU EMC	EN61204-3	High severity level	as below		
Harmonic Current	EN61000-3-2	Class A		All models	
		Class C		> 50 W	
Radiated	EN61000-4-3	3	A		
EFT	EN61000-4-4	3	A		
Surges	EN61000-4-5	Installation class 3	A		
Conducted	EN61000-4-6	3	A		
Dips and Interruptions	EN55035 (100 VAC)	Dip >95% (0 VAC), 8.3ms	A		
		Dip 30% (70 VAC), 416ms	A		
		Dip >95% (0 VAC), 4160ms	B		
	EN55035 (240 VAC)	Dip >95% (0 VAC), 10.0ms	A		
		Dip 30% (168 VAC), 500ms	A		
		Dip >95% (0 VAC), 5000ms	B		
	EN60601-1-2 (100 VAC)	Dip >95% (0 VAC), 10.0ms	A		
		Dip 60% (40 VAC), 100ms	A		Derate Output Power to 250 W
		Dip 30% (70 VAC), 500ms	A		
	EN60601-1-2 (240 VAC)	Dip >95% (0 VAC), 5000ms	B		
		Dip >95% (0 VAC), 10.0ms	A		
		Dip 60% (96 VAC), 100ms	A		
		Dip 30% (168 VAC), 500ms	A		
		Dip >95% (0 VAC), 5000ms	B		

Safety Approvals

Safety Certification	Safety Standard	Notes & Conditions
CB Report	IEC60950-1 & IEC62368-1	Information Technology
	IEC60601-1 Including Risk Management	Medical
UL	UL62368-1, CSA62368-1 via cUL	Information Technology
	ANSI/AAMI ES60601-1 & CSA C22.2, No.60601-1	Medical
EN	EN62368-1	Information Technology
	EN60601-1	Medical
Equipment Protection Class	Class I	See safety agency conditions of acceptability for details
CE	Meets all applicable directives	
UKCA	Meets all applicable legislation	

Means of Protection		Category
Primary to Secondary	2 x MOPP (Means of Patient Protection)	IEC60601-1
Primary to Earth	1 x MOPP (Means of Patient Protection)	

Mechanical Details

GSP500-EF

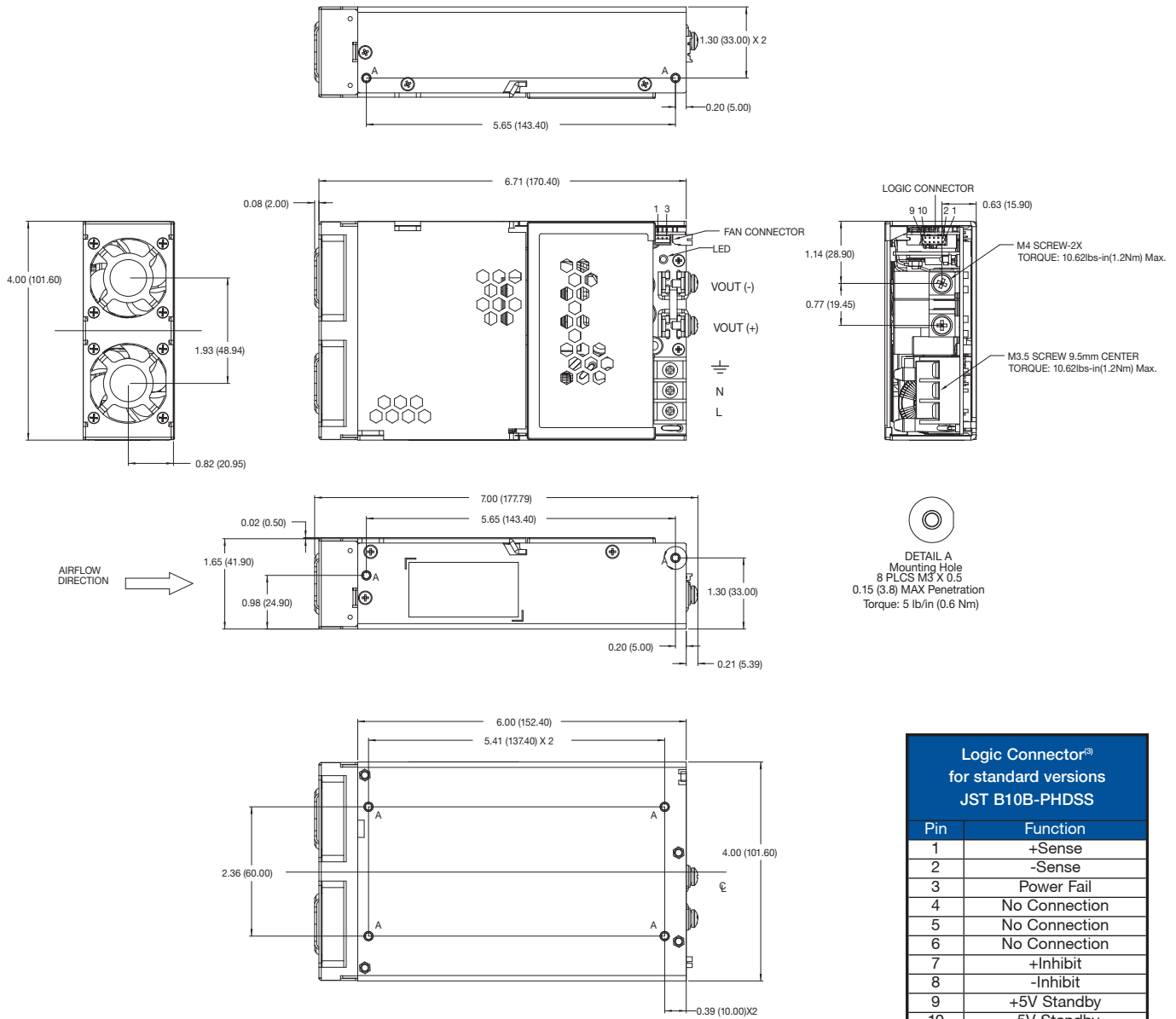

DETAIL A
Mounting Hole
8 PLCS M3 X 0.5
0.15 (3.8) MAX Penetration
Torque: 5 lb/in (0.6 Nm)

Logic Connector ⁽³⁾ for standard versions JST B10B-PHDSS	
Pin	Function
1	+Sense
2	-Sense
3	Power Fail
4	No Connection
5	No Connection
6	No Connection
7	+Inhibit
8	-Inhibit
9	+5V Standby
10	-5V Standby

Fan Connector ⁽³⁾ S3B-PH-KL(LF)	
Pin	Function
1	+12 V
2	N/C
3	GND

Logic Connector ⁽³⁾ For Current Share Versions -P JST B10B-PHDSS	
Pin	Function
1	+Sense
2	-Sense
3	Power Fail
4	No Connection
5	Current Share
6	Current Share
7	+Inhibit
8	-Inhibit
9	+5V Standby
10	-5V Standby

Notes

1. All dimensions in inches (mm).
2. Tolerance .xx = ±0.02 (0.50); .xxx = ±0.01 (0.25)

3. Fan connector mates with JST housing PHR-3 and SPH-002T-P0.5S crimp terminals or equivalent. Logic connector J301 mates with JST housing PHDR-10VS and SPHD-001T-P0.5 crimp terminals.

Mechanical Details

GSP500

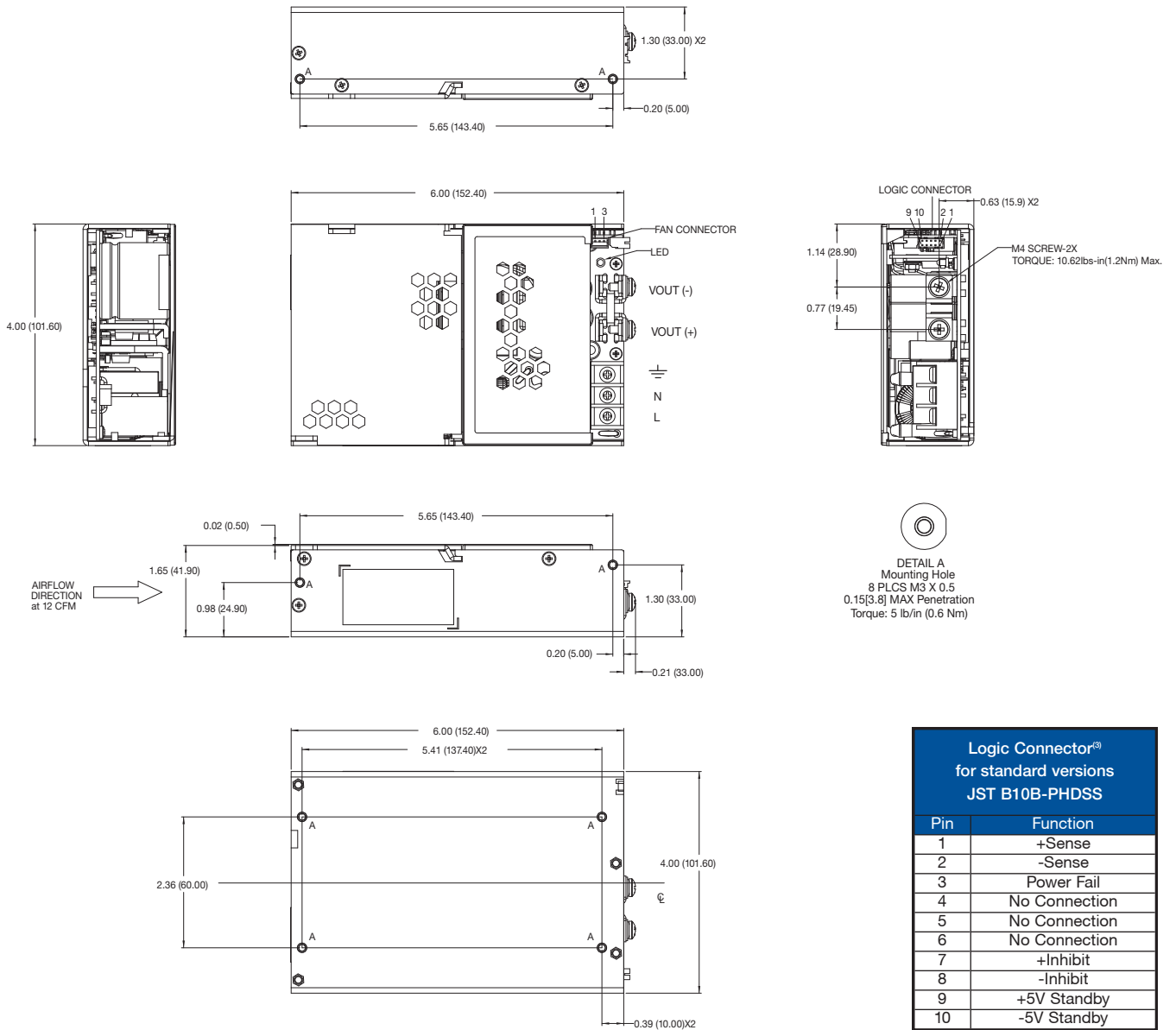

Logic Connector ⁽³⁾ for standard versions JST B10B-PHDSS	
Pin	Function
1	+Sense
2	-Sense
3	Power Fail
4	No Connection
5	No Connection
6	No Connection
7	+Inhibit
8	-Inhibit
9	+5V Standby
10	-5V Standby

Fan Connector ⁽³⁾ S3B-PH-KL(LF)	
Pin	Function
1	+12 V
2	N/C
3	GND

Logic Connector ⁽³⁾ For Current Share Versions -P JST B10B-PHDSS	
Pin	Function
1	+Sense
2	-Sense
3	Power Fail
4	No Connection
5	Current Share
6	Current Share
7	+Inhibit
8	-Inhibit
9	+5V Standby
10	-5V Standby

Notes

- All dimensions in inches (mm).
- Tolerance .xx = ±0.02 (0.50); .xxx = ±0.01 (0.25)
- Fan connector mates with JST housing PHR-3 and SPH-002T-P0.5S crimp terminals or equivalent. Logic connector J301 mates with JST housing PHDR-10VS and SPHD-001T-P0.5 crimp terminals.

Thermal Considerations - GSP500PSxx Models Only

In order to ensure safe operation of the PSU in the end-use equipment, the temperature of the components listed in the table below must not be exceeded. Temperature should be monitored using K type thermocouples placed on the hottest part of the component (out of direct air flow). See below for component locations.

Temperature Measurements (At Ambient 50 °C)	
Component	Max Temperature °C
T1 Coil	120 °C
L3 Coil	120 °C
Q7 Body	120 °C
Q102 Body	120 °C
C20	105 °C
C102	105 °C

Service Life

The estimated service life of the GSP500PSxx Series is determined by the cooling arrangements and load conditions experienced in the end application. Due to the uncertain nature of the end application this estimated service life is based on the actual measured temperature of a key capacitors with in the product when installed by the end application. The worst case of the two figures should be taken as the indicative service life in 24/7 operation.

The graph below expresses the estimated lifetime of a given component temperature and assumes continuous operation at this temperature.

Estimated Service Life vs Component Temperature

