

1. Features

- Low EMI noise and small footprint (5mm²) using inductor-embedded ferrite substrate
- High efficiency using synchronous rectifier technology at 3MHz operation
- PFM/PWM automatic mode switching function
- Smooth mode transition between PFM mode and PWM mode with low-ripple-voltage PFM mode
- 2% DC voltage accuracy over full load current range
- Wide input voltage range : 2.3~5.5V
- Maximum Load Current: 600mA (depends on output voltage)
- Fixed output voltage: 0.8V – 4V (factory setting, 50mV step)
- Internal soft start, overcurrent protection



2. Description

The LXDC2HL series is a low power step-down DC-DC converter suitable for space-limited or noise-sensitive applications. The device utilizes an inductor-embedded ferrite substrate that reduces radiated EMI noise and conduction noise.

By adding input/output capacitors, it can be used as an LDO replacement. Its low noise and easy-to-assemble features assure reliable power supply quality.

The device works in PFM mode at light load for extended battery life. At heavy load, it changes to PWM mode automatically and maintains high efficiency using synchronous rectifying technology.

The device provides good output voltage accuracy even in PFM mode. It maintains 2% DC voltage accuracy over the full current range (0-600mA), and shows very smooth mode transition between PFM mode and PWM mode.

3. Typical Application Circuit

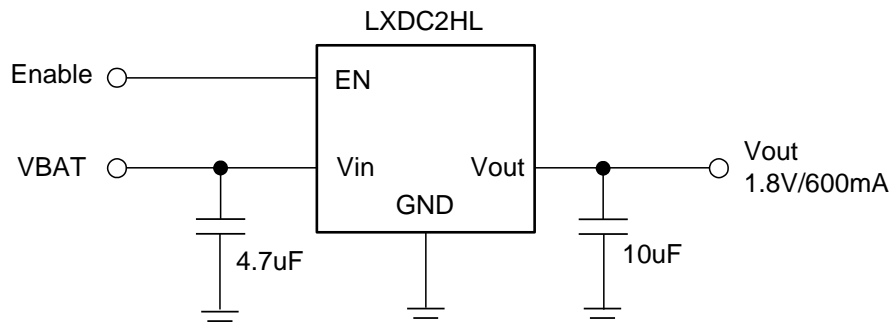

4. Mechanical details

4-1 Outline

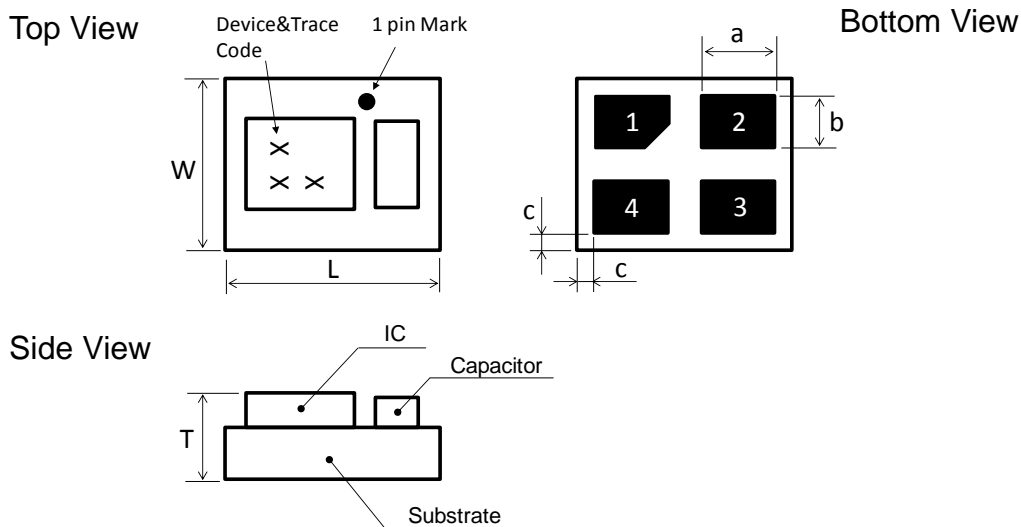

Unit: mm

Mark	Dimension
L	2.5 +/- 0.2
W	2.0 +/- 0.2
T	1.1 MAX
a	0.85 +/- 0.1
b	0.60 +/- 0.1
c	0.15 +/- 0.15

4-2. Pin Function

Pin	Symbol	I/O	Description
1	Vin	Input	Vin pin supplies current to the LXDC2HL internal regulator.
2	EN	Input	This is the ON/OFF control pin of the device. Connecting this pin to GND keeps the device in shutdown mode. Pulling this pin to Vin enables the device with soft start. This pin must not be left floating and must be terminated. If this pin is left open, the device may be off around 100mA output. EN=H: Device ON, EN=L: Device OFF
3	Vout	Output	Regulated voltage output pin. Apply output load between this pin and GND.
4	GND	-	Ground pin

4-3. Functional Block Diagram

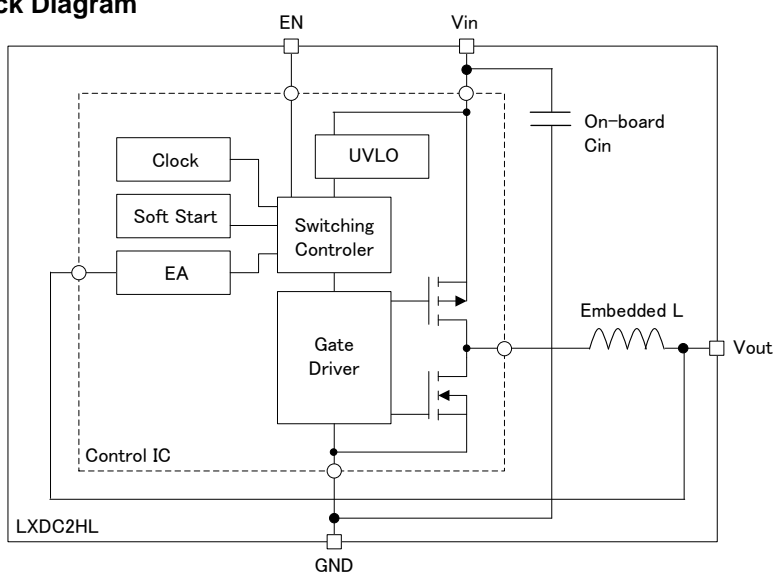

5. Ordering Information

Part number	Output Voltage	Device Specific Feature	MOQ
LXDC2HL10A-080	1.0V	Standard Type	T/R, 3000pcs/R
LXDC2HL11A-314	1.1V	Standard Type	T/R, 3000pcs/R
LXDC2HL12A-050	1.2V	Standard Type	T/R, 3000pcs/R
LXDC2HL1CA-322	1.25V	Standard Type	T/R, 3000pcs/R
LXDC2HL13A-082	1.3V	Standard Type	T/R, 3000pcs/R
LXDC2HL1DA-087	1.35V	Standard Type	T/R, 3000pcs/R
LXDC2HL15A-051	1.5V	Standard Type	T/R, 3000pcs/R
LXDC2HL18A-052	1.8V	Standard Type	T/R, 3000pcs/R
LXDC2HL23A-323	2.3V	Standard Type	T/R, 3000pcs/R
LXDC2HL25A-053	2.5V	Standard Type	T/R, 3000pcs/R
LXDC2HL28A-243	2.8V	Standard Type	T/R, 3000pcs/R
LXDC2HL30A-054	3.0V	Standard Type	T/R, 3000pcs/R
LXDC2HL33A-055	3.3V	Standard Type	T/R, 3000pcs/R

Output voltage can be set 50mV step from 0.8V to 4.0V. Please ask Murata representative.

6. Electrical Specification

6-1 Absolute maximum ratings

Parameter	Symbol	rating	Unit
Input voltage	V_{in} , EN	6.3	V
Operating ambient temperature	T_a	-40 to +85	°C
Operating IC temperature	T_{IC}	-40 to +125	°C
Storage temperature	T_{STO}	-40 to +85	°C

6-2 Electrical characteristics ($T_a=25^\circ\text{C}$)

Parameter	Symbol	Condition	Min.	Typ.	Max.	Unit	
Input voltage	V_{in}		2.3	3.6	5.5	V	
UVLO voltage	UVLO		1.0	1.4	1.8	V	
Input leak current	lin-off	$V_{in}=3.6\text{V}$, EN=0V	LXDC2HL10A-080	0	2	uA	
			LXDC2HL11A-314				
			LXDC2HL12A-050				
			LXDC2HL1CA-322				
			LXDC2HL13A-082				
			LXDC2HL1DA-087				
			LXDC2HL15A-051				
			LXDC2HL18A-052				
			LXDC2HL23A-323				
		LXDC2HL25A-053					
		$V_{in}=5.0\text{V}$, EN=0V	LXDC2HL28A-243				
			LXDC2HL30A-054				
			LXDC2HL33A-055				
Output voltage accuracy	Vout	$V_{in}-V_{out}>1\text{V}$	LXDC2HL10A-080	0.976	1.0	1.024	V
			LXDC2HL11A-314	1.076	1.1	1.124	
			LXDC2HL12A-050	1.176	1.20	1.224	
			LXDC2HL1CA-322	1.225	1.25	1.275	
			LXDC2HL13A-082	1.274	1.30	1.326	
			LXDC2HL1DA-087	1.323	1.35	1.377	
			LXDC2HL15A-051	1.47	1.50	1.53	
			LXDC2HL18A-052	1.764	1.80	1.836	
			LXDC2HL23A-323	2.254	2.30	2.346	
		LXDC2HL25A-053	2.45	2.50	2.55		
		$V_{in}-V_{out}>0.7\text{V}$	LXDC2HL28A-243	2.744	2.80	2.856	
			LXDC2HL30A-054	2.94	3.00	3.06	
		$V_{in}-V_{out}>0.5\text{V}$	LXDC2HL33A-055	3.234	3.30	3.366	

Parameter	Symbol	Condition	Min.	Typ.	Max.	Unit	
Load current range	I _{out}	LXDC2HL10A-080	0		600	mA	
		LXDC2HL11A-314					
		LXDC2HL12A-050					
		LXDC2HL1CA-322					
		LXDC2HL13A-082					
		LXDC2HL1DA-087					
		LXDC2HL15A-051					
		LXDC2HL18A-052					
		LXDC2HL23A-323	0		500		
		LXDC2HL25A-053					
		LXDC2HL28A-243	0		450		
		LXDC2HL30A-054	0		400		
		LXDC2HL33A-055	0		300		
		Ripple voltage	V _{rpl}	V _{in} =3.6V, I _{out} =300mA, BW=100MHz			15
LXDC2HL10A-080							
LXDC2HL11A-314							
LXDC2HL12A-050							
LXDC2HL1CA-322							
LXDC2HL13A-082							
LXDC2HL1DA-087							
LXDC2HL15A-051							
LXDC2HL18A-052							
LXDC2HL23A-323							
LXDC2HL25A-053							
V _{in} =5V, I _{out} =300mA, BW=100MHz	LXDC2HL28A-243						
	LXDC2HL30A-054						
	LXDC2HL33A-055						

Parameter	Symbol	Condition	Min.	Typ.	Max.	Unit			
Efficiency	EFF	Vin=3.6V, Iout=150mA	LXDC2HL10A-080		78		%		
			LXDC2HL11A-314		79				
			LXDC2HL12A-050		80				
			LXDC2HL1CA-322		81				
			LXDC2HL13A-082		81				
			LXDC2HL1DA-087		82				
			LXDC2HL15A-051		83				
			LXDC2HL18A-052		85				
			LXDC2HL23A-323		87				
			LXDC2HL25A-053		88				
		Vin=5V, Iout=150mA	LXDC2HL28A-243		86				
			LXDC2HL30A-054		87				
			LXDC2HL33A-055		88				
EN control voltage	VENH	ON ; Enable	1.4		Vin	V			
	VENL	OFF ; Disable	0		0.25	V			
SW Frequency	Fosc		2.5	3.0	3.5	MHz			
Over current protection	OCP	LXDC2HL10A-080	600	900	1200	mA			
		LXDC2HL11A-314							
		LXDC2HL12A-050							
		LXDC2HL1CA-322							
		LXDC2HL13A-082							
		LXDC2HL1DA-087							
		LXDC2HL15A-051							
		LXDC2HL18A-052							
		LXDC2HL23A-323							
		LXDC2HL25A-053					500	900	1200
		LXDC2HL28A-243					500	900	1200
		LXDC2HL30A-054					400	700	1200
		LXDC2HL33A-055					300	700	1200
		If the over current event continues less than Tlatch, auto-recovery. If the over current event continues more than Tlatch, latch-up. Restart by toggling EN voltage or Vin voltage							
	Tlatch	Latch-up mask time @ Vout=0.8×Vnom		20		usec			
Start-up time	Ton			0.9		msec			

(*1) External capacitors (Cin: 4.7uF, Cout: 10uF) should be placed near the module for proper operation.

(*2) The above characteristics are tested using the test circuit in section 8.

6-3 Thermal and Current De-rating Information

The following figures show the power dissipation and temperature rise characteristics. These data are measured on Murata's evaluation board of this device at no air-flow condition.

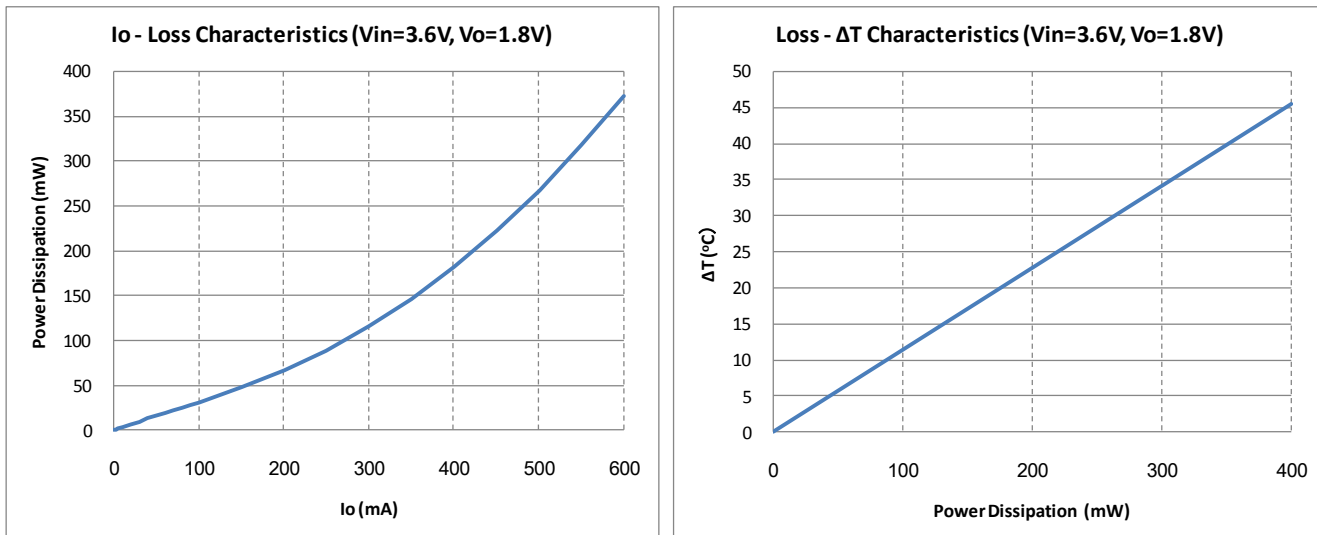

The output current of the device may need to be de-rated if it is operated in a high ambient temperature or in a continuous power delivering application. The amount of current de-rating is highly dependent on the environmental thermal conditions, i.e. PCB design, nearby components or effective air flows. Care should especially be taken in applications where the device temperature exceeds 85°C.

The IC temperature of the device must be kept lower than the maximum rating of 125 °C. It is generally recommended to take an appropriate de-rating to IC temperature for a reliable operation. A general de-rating for the temperature of semiconductor is 80%.

MLCC capacitor's reliability and the lifetime is also dependant on temperature and applied voltage stress. Higher temperature and/or higher voltage cause shorter lifetime of MLCC, and the degradation can be described by the Arrhenius model. The most critical parameter of the degradation is IR (Insulation Resistance). The below figure shows MLCC's B1 life based on a failure rate reaching 1%. It should be noted that wear-out mechanisms in MLCC capacitor is not reversible but cumulative over time.

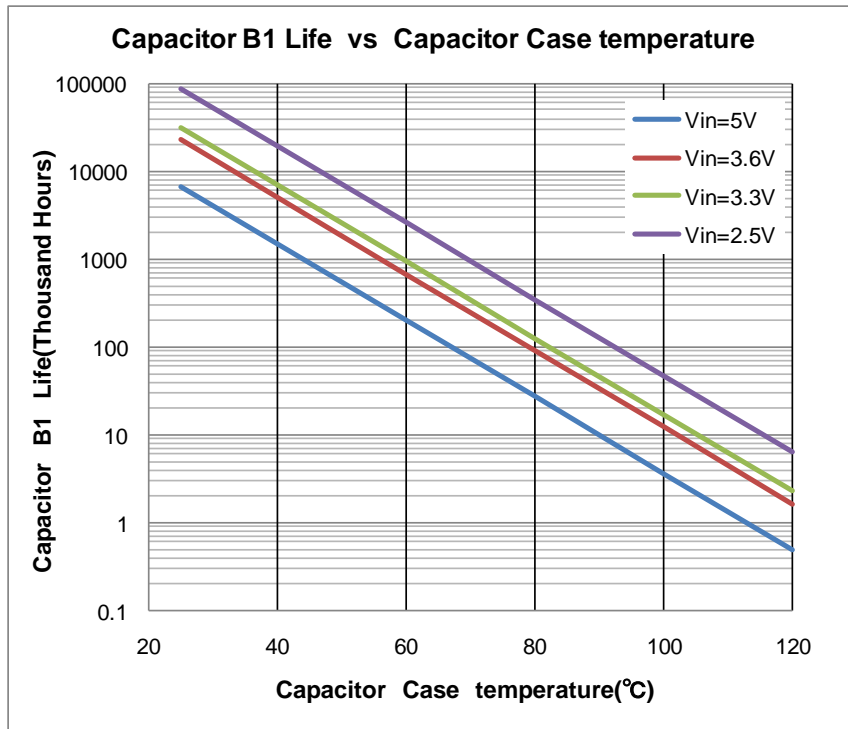

The following steps should be taken before the design fix of user's set for reliable operation.

1. The ambient temperature of the device should be kept below 85 °C
2. The IC temperature should be measured on the worst condition of each application. The temperature must be kept below 125 °C. An appropriate de-rating of temperature and/or output current should be taken.
3. The MLCC temperature should be measured on the worst condition of each application. Considering the above figure, it should be checked if the expected B1 life of MLCC is acceptable or not.

7. Detailed Description

PFM/PWM Mode

If the load current decreases, the converter will enter PFM mode automatically. In PFM mode, the device operates in discontinuous current mode with a sporadic switching pulse to keep high efficiency at light load.

The device uses constant on-time control in PFM operation, which produces a low ripple voltage and accurate output voltage compared with other PFM architectures. Because of the architecture, DC output voltage can be kept within +/-2% range of the nominal voltage and the output ripple voltage in PFM mode can be reduced by just increasing the output capacitor.

The transition between PFM and PWM is also seamless and smooth.

The transition current between PFM and PWM is dependent on V_{in} , V_{out} and other factors, but the approximate threshold is about 100-200mA.

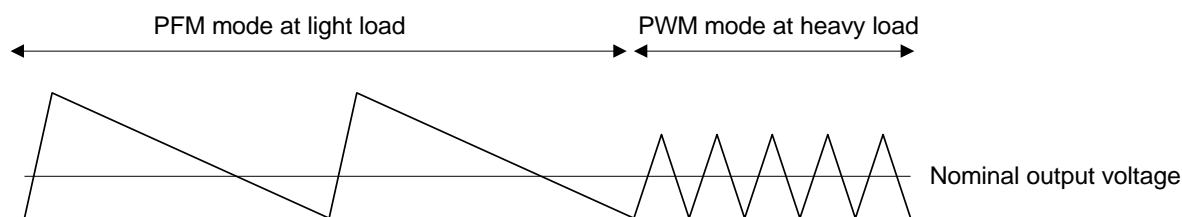

UVLO (Under Voltage Lock Out)

The input voltage (V_{in}) must reach or exceed the UVLO voltage (1.4Vtyp) before the device begins the start up sequence even when the EN pin is kept high. The UVLO function protects against unstable operation at low V_{in} levels.

Soft Start

The device has an internal soft-start function that limits the inrush current during start-up. The soft-start system progressively increases the switching on-time from a minimum pulse-width to that of normal operation. Because of this function, the output voltage increases gradually from zero to nominal voltage at start-up event. The nominal soft-start time is 0.9msec. If you prefer a faster soft-start time, please contact a Murata representative.

Enable

The device starts operation when EN is set high and starts up with soft start. For proper operation, the EN pin must be terminated to logic high and must not be left floating. If the pin is left open, the device may operate at light load but will not work at heavy load.

Pulling the EN pin to logic low forces the device into shutdown. The device does not have a discharge function when it turns off. If you prefer a discharge function, please contact a Murata representative.

100% Duty Cycle Operation

The device can operate in 100% duty cycle mode, in which the high-side switch is constantly turned ON, thereby providing a low input-to-output voltage difference.

When V_{in} and V_{out} become close and the duty cycle approaches 100%, the switching pulse will skip the nominal switching period and the output voltage ripple may be larger than other conditions. It should be noted that this condition does not mean a failure of the device.

Over Current Protection

When the output current reaches the OCP threshold, the device narrows the switching duty and decreases the output voltage. If the OCP event is removed within the mask time (20usec typ), the output voltage recovers to the nominal value automatically. If the OCP event continues over the mask time, the device will shutdown.

After it is shut down, it can be restarted by toggling the V_{in} or EN voltage.

8. Test Circuit

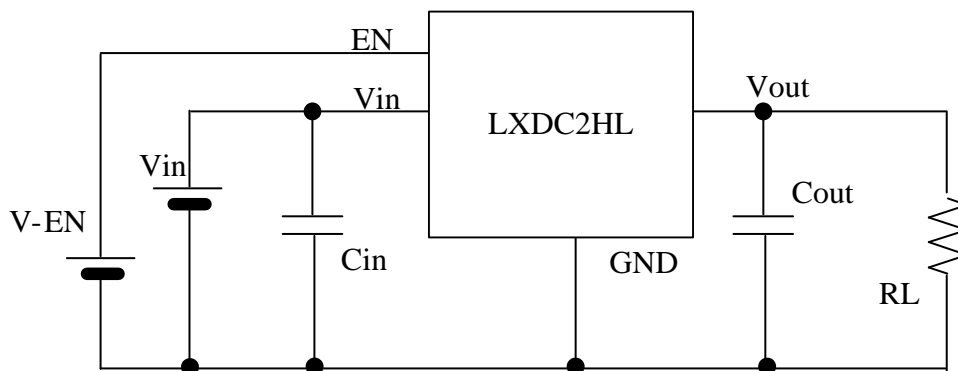

Cin : 4.7uF/6.3V (GRM188B30J475K)

Cout : 10uF/6.3V (GRM188B30J106M)

9. Measurement Data

Micro DC-DC Converter evaluation board (P2LX0244)

Measurement setup

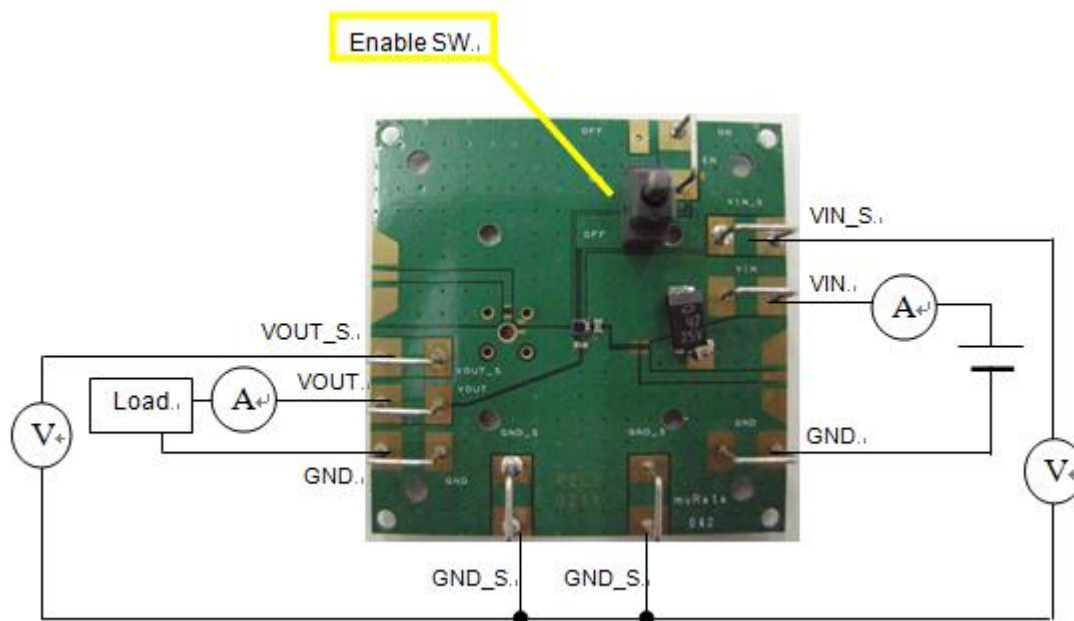

The enable switch has three positions.

1. When it is toggled to “ON” side, the device starts operation.
2. When it is toggled to “OFF” side, the device stops operation and remains in shut down status.
3. When it is set to middle of “ON” and “OFF”, the EN pin floats and an external voltage can be applied to the EN terminal pin on the EVB. If you don’t apply an external voltage to EN pin, the enable switch should not to be set to the middle position.

※The 47uF capacitor is for the evaluation kit only, and has been added to compensate for the long test cables.

Typical Measurement Data (reference purpose only) (Ta=25°C)

Efficiency

• Vin=3.6V, Vout=1.0V

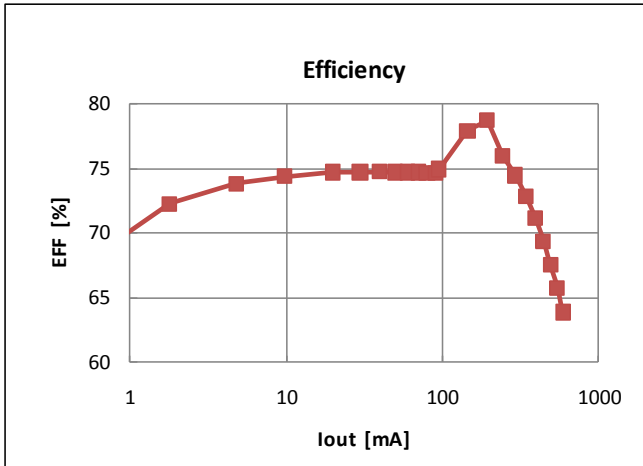

• Vin=3.6V, Vout=1.2V

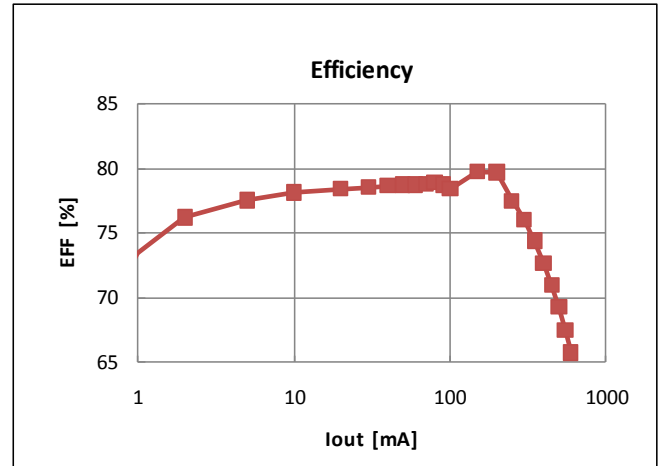

• Vin=3.6V, Vout=1.3V

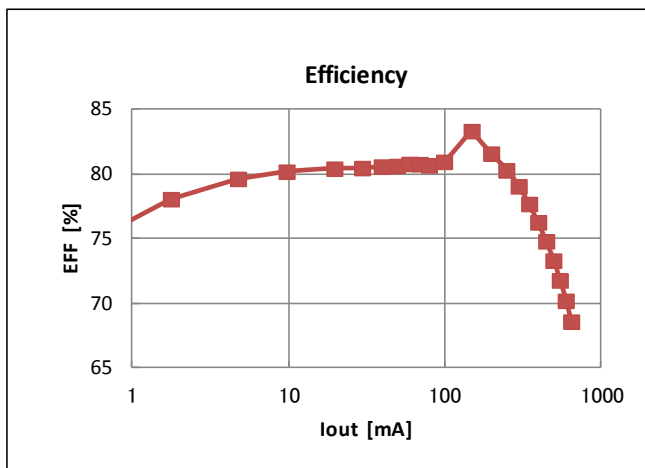

• Vin=3.6V, Vout=1.35V

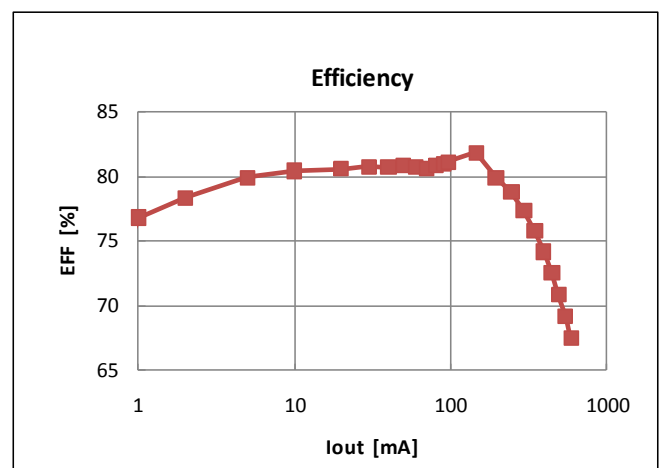

• Vin=3.6V, Vout=1.5V

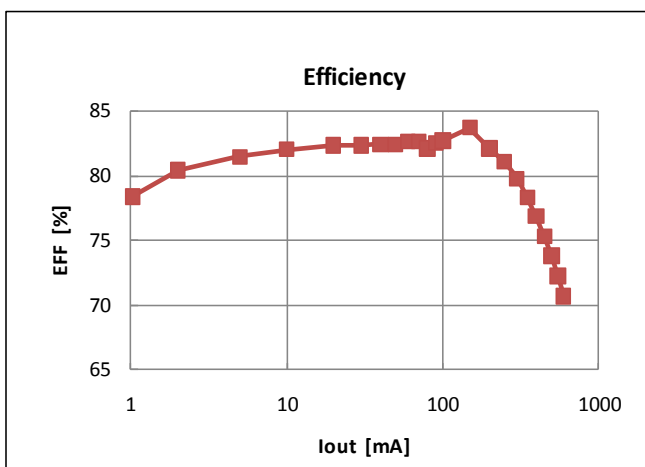

• Vin=3.6V, Vout=1.8V

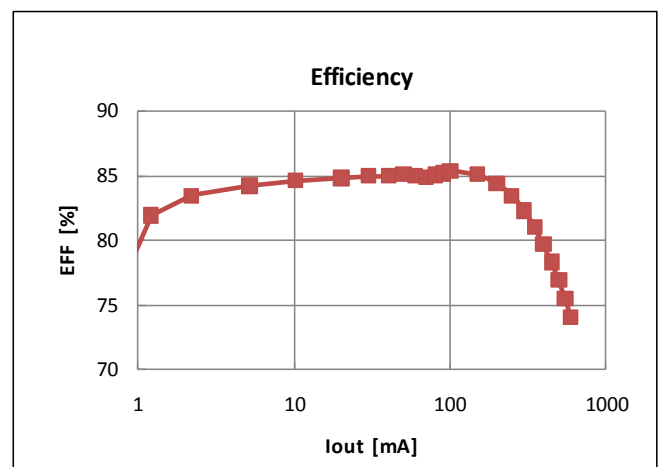

• Vin=5.0V, Vout=2.5V

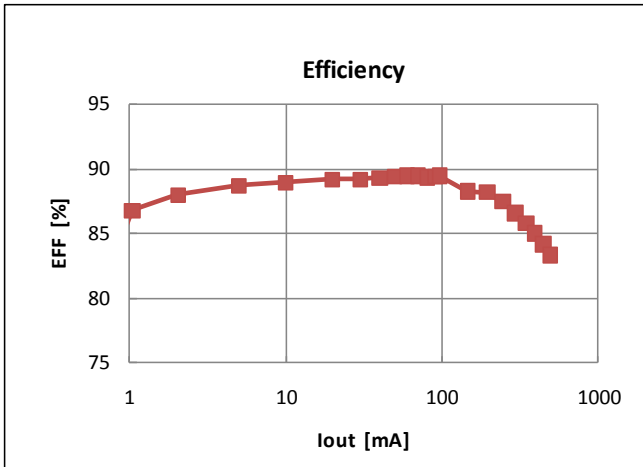

• Vin=5.0V, Vout=3.0V

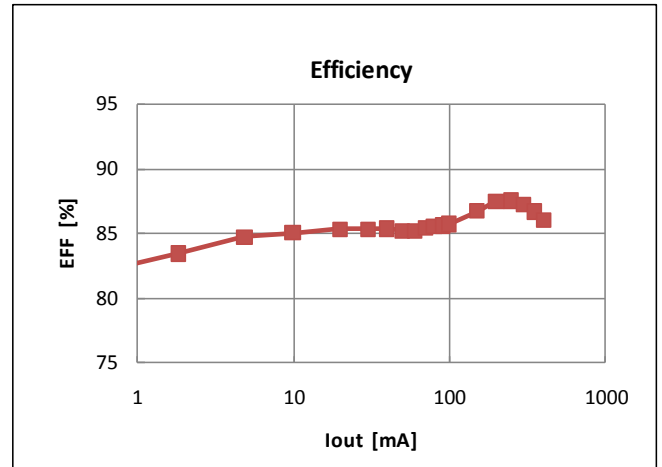

• Vin=5.0V, Vout=3.3V

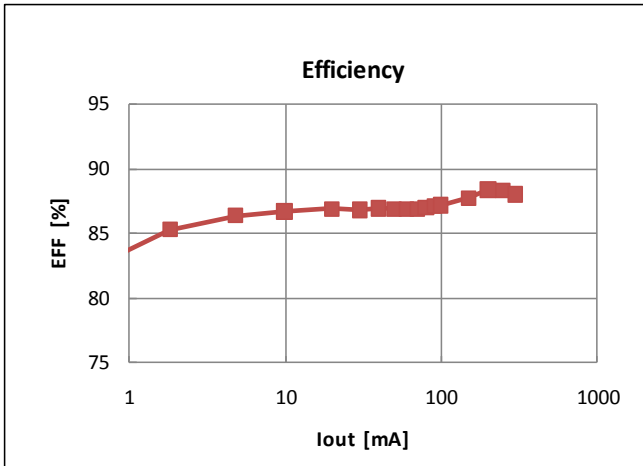

Typical Measurement Data (reference purpose only) (Ta=25°C)

Load Regulation

• Vin=3.6V, Vout=1.0V

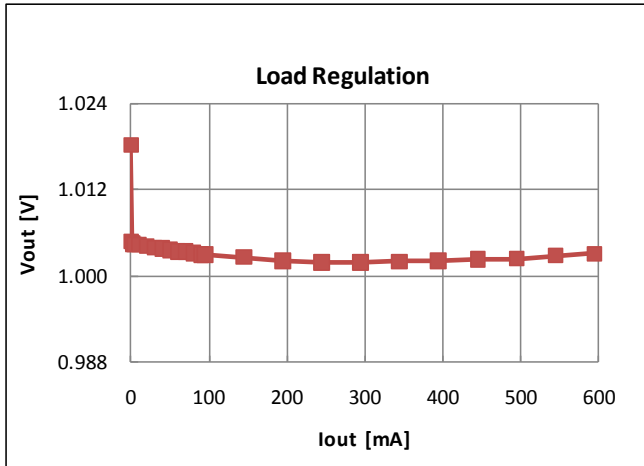

• Vin=3.6V, Vout=1.2V

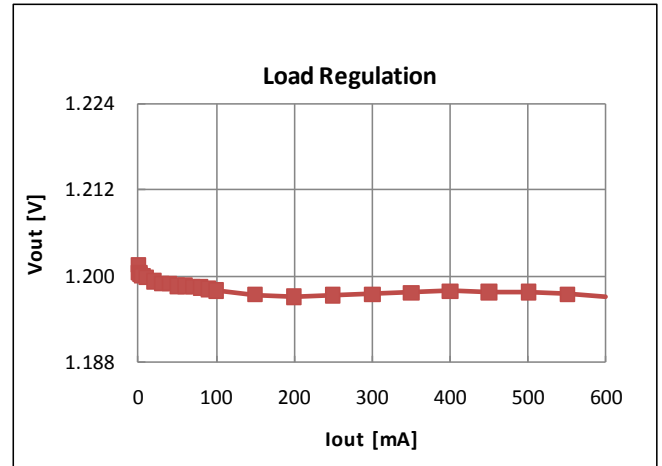

• Vin=3.6V, Vout=1.3V

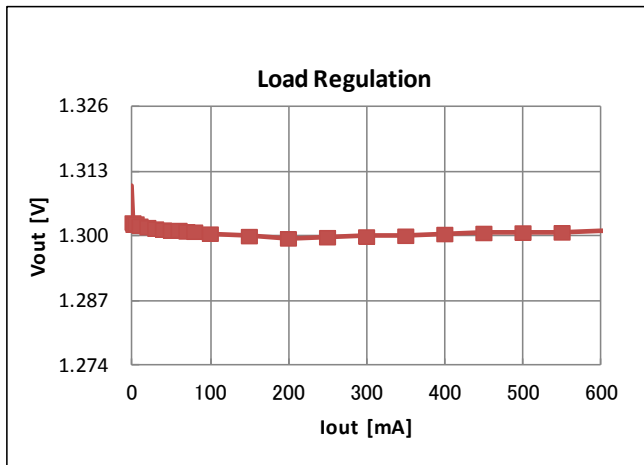

• Vin=3.6V, Vout=1.35V

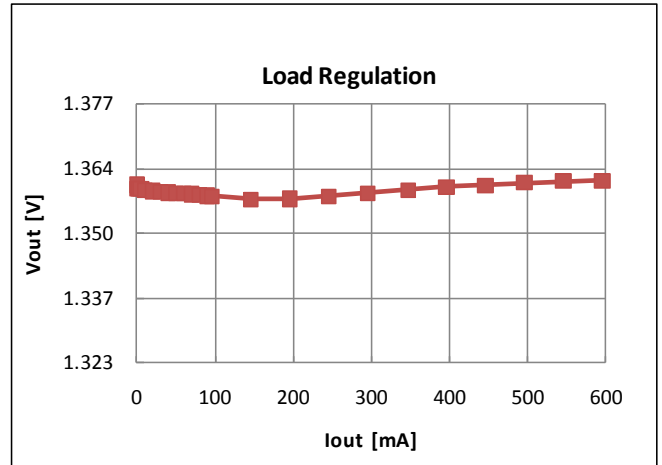

• Vin=3.6V, Vout=1.5V

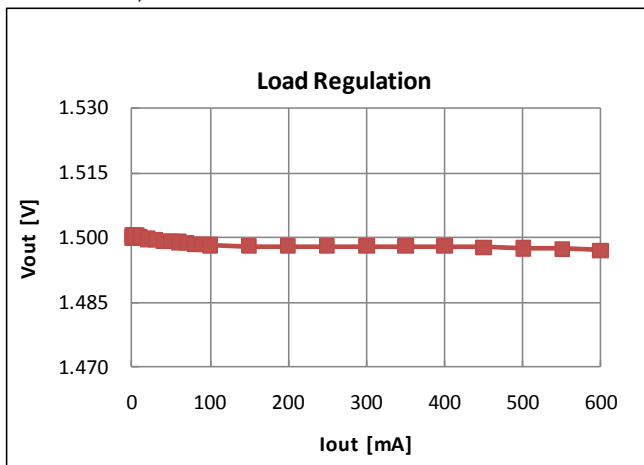

• Vin=3.6V, Vout=1.8V

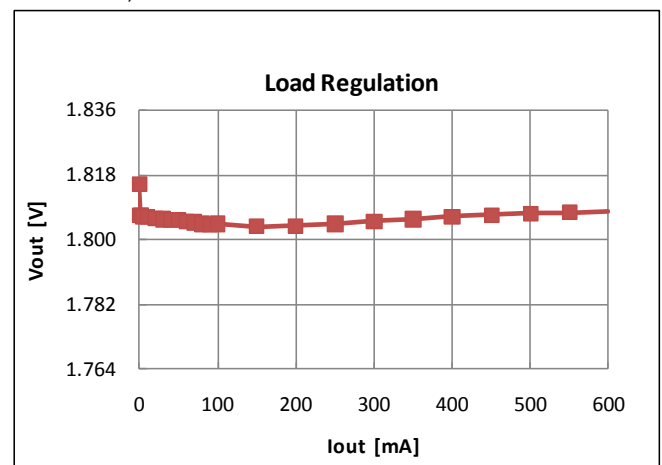

• $V_{in}=5.0V$, $V_{out}=2.5V$

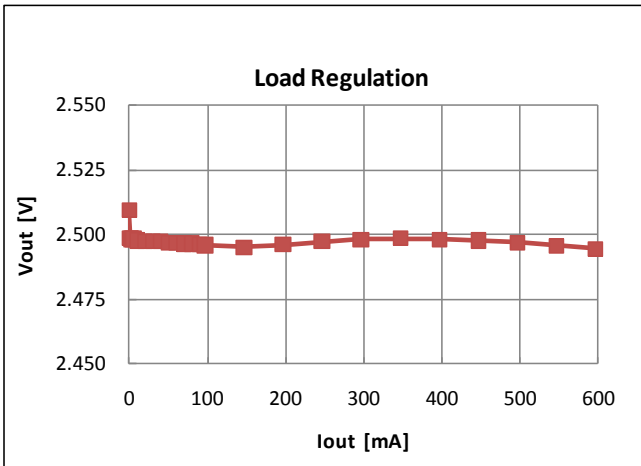

• $V_{in}=5.0V$, $V_{out}=3.0V$

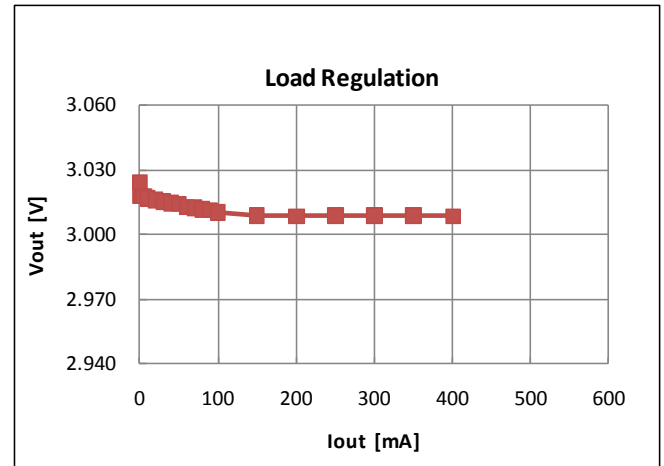

• $V_{in}=5.0V$, $V_{out}=3.3V$

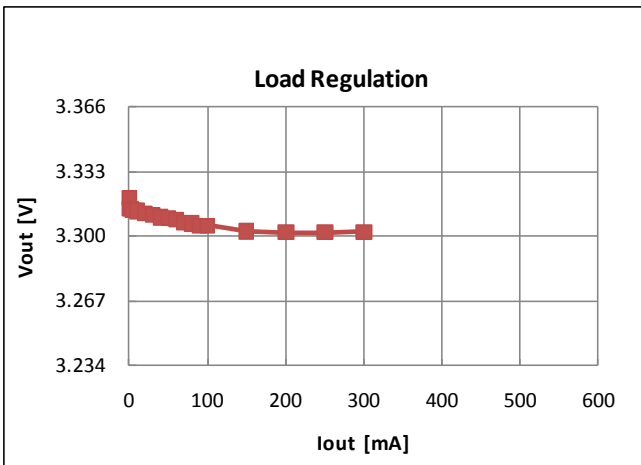

Typical Measurement Data (reference purpose only)

Output Ripple-Noise

• $V_{in}=3.6V$, $V_{out}=1.0V$, BW : 150MHz

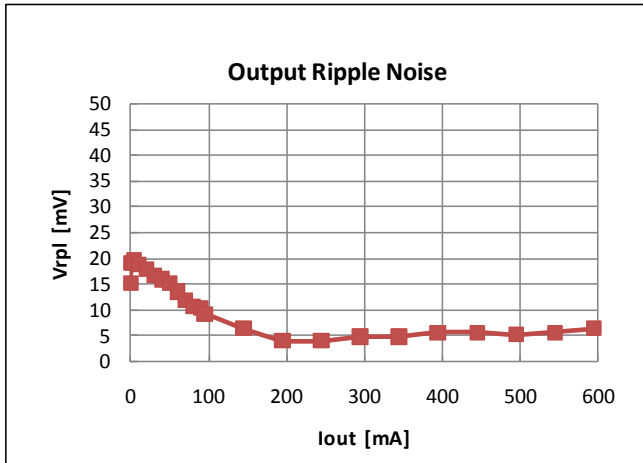

• $V_{in}=3.6V$, $V_{out}=1.2V$, BW: 150MHz

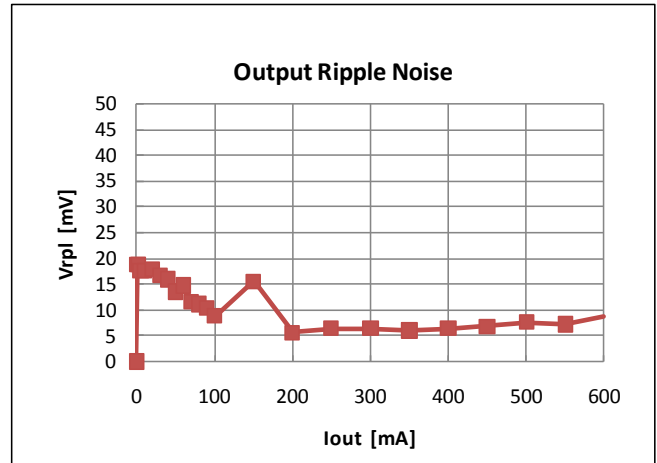

• $V_{in}=3.6V$, $V_{out}=1.3V$, BW: 150MHz

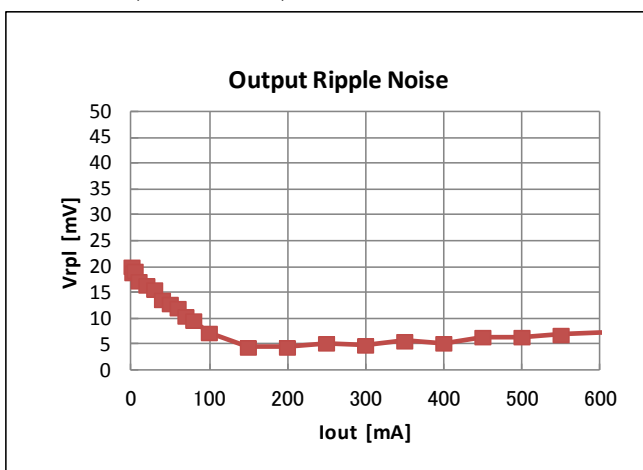

• $V_{in}=3.6V$, $V_{out}=1.35V$, BW: 150MHz

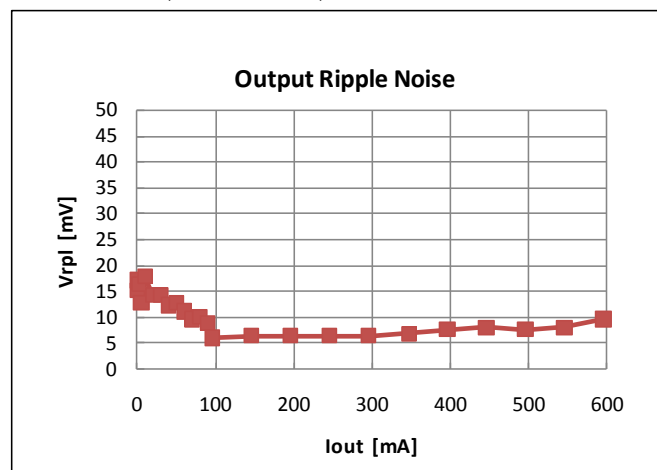

• $V_{in}=3.6V$, $V_{out}=1.5V$, BW: 150MHz

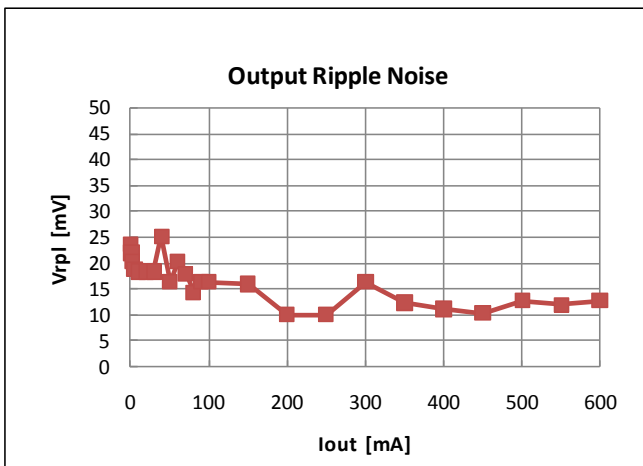

• $V_{in}=3.6V$, $V_{out}=1.8V$, BW: 150MHz

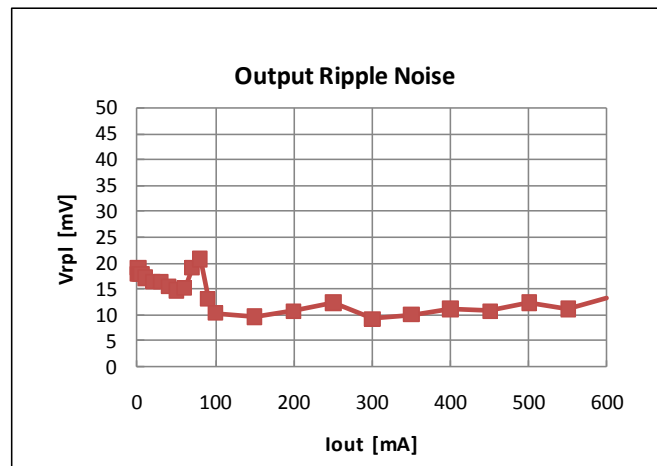

• $V_{in}=5.0V$, $V_{out}=2.5V$, BW: 150MHz

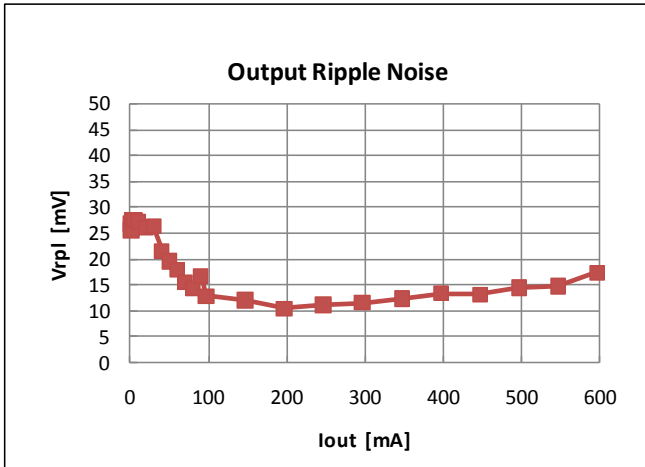

• $V_{in}=5.0V$, $V_{out}=3.0V$, BW: 150MHz

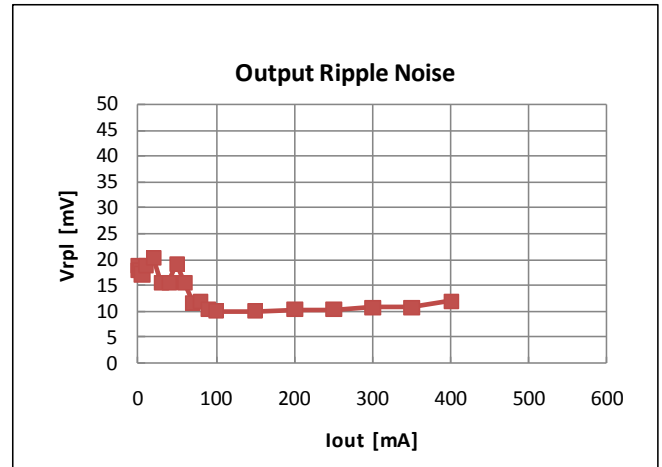

• $V_{in}=5.0V$, $V_{out}=3.3V$, BW: 150MHz

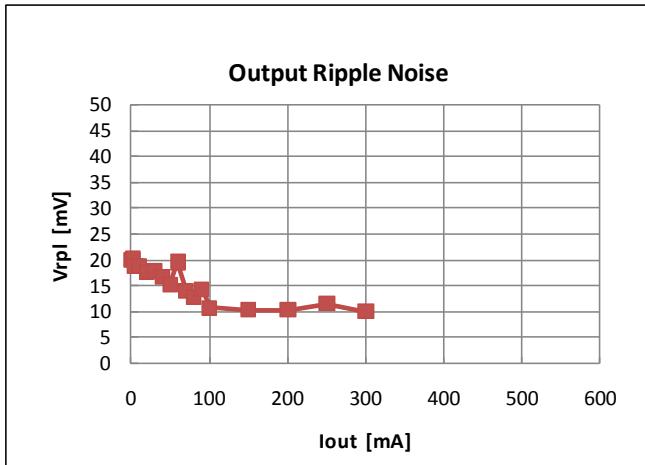

Typical Measurement Data (reference purpose only) (Ta=25°C)

Load Transient Response

• Vin=3.6V, Vout=1.0V

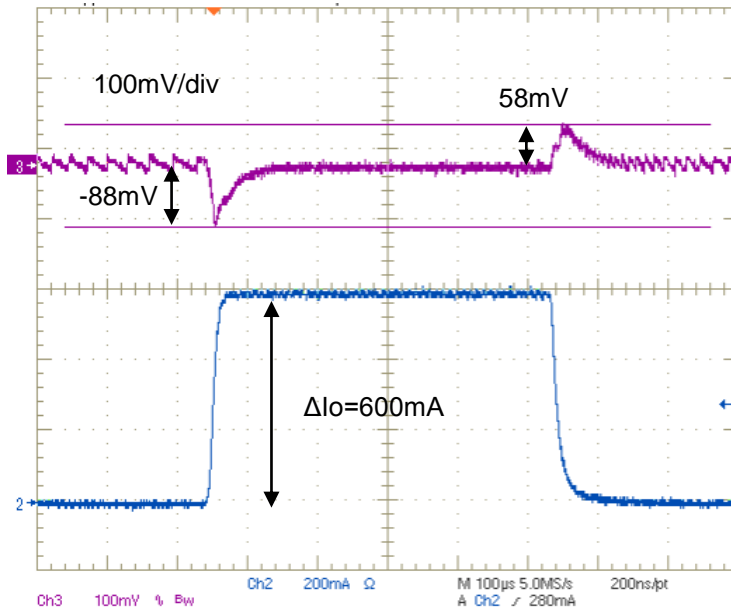

• Vin=3.6V, Vout=1.2V

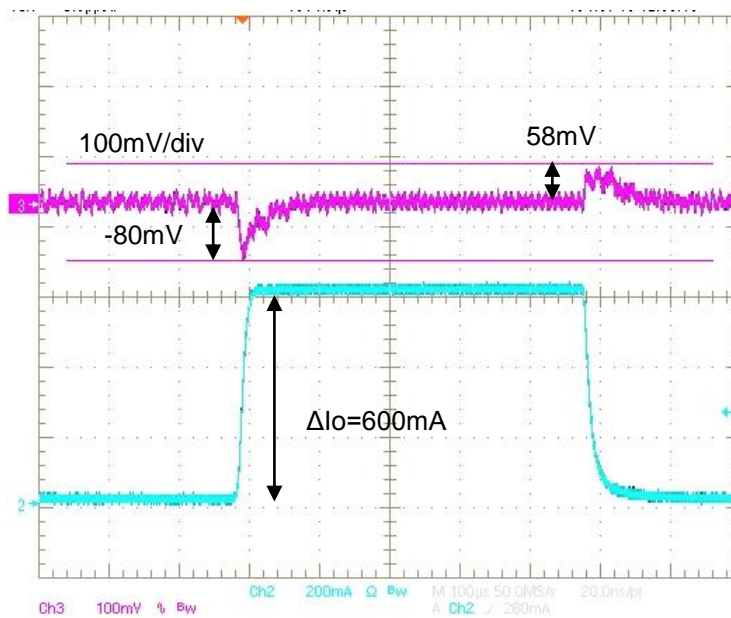

• Vin=3.6V, Vout=1.35V

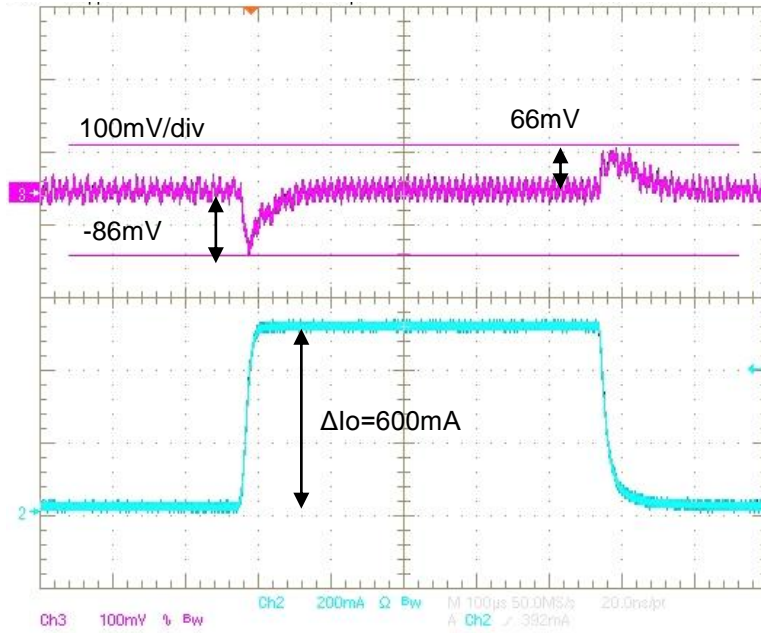

• Vin=3.6V, Vout=1.5V

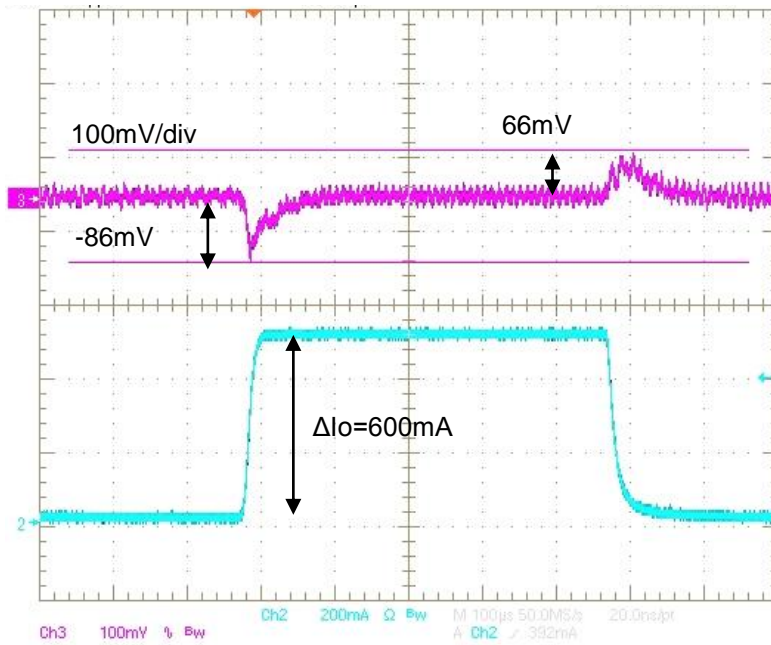

• $V_{in}=3.6V$, $V_{out}=1.8V$

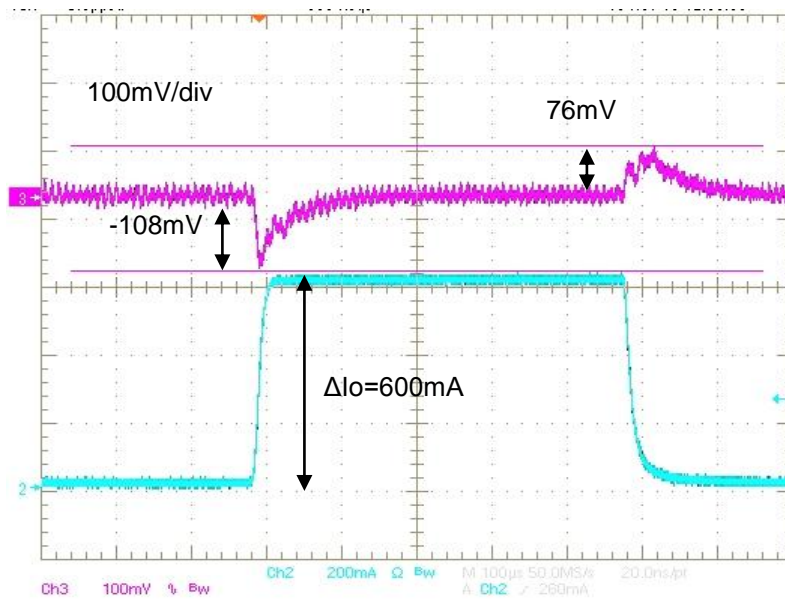

• $V_{in}=3.6V$, $V_{out}=2.5V$

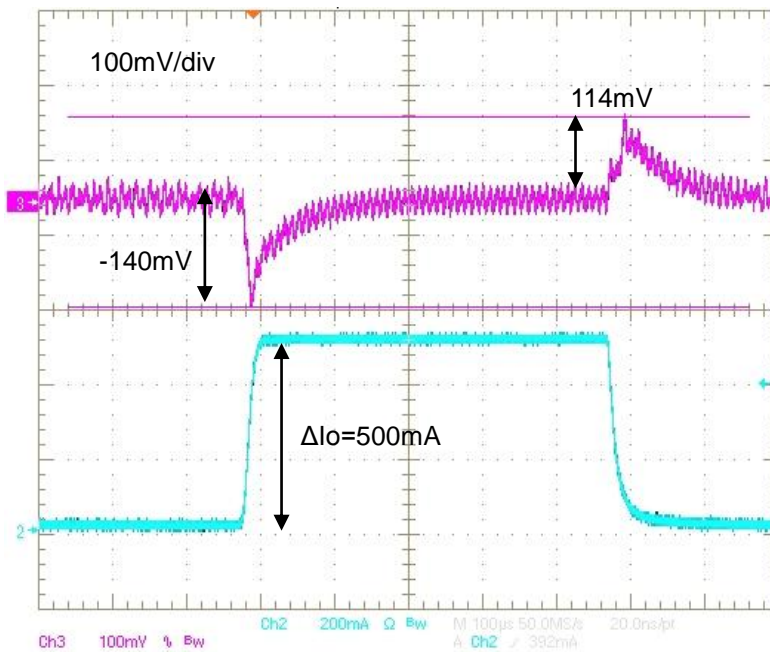

• Vin=5.0V, Vout=3.0V

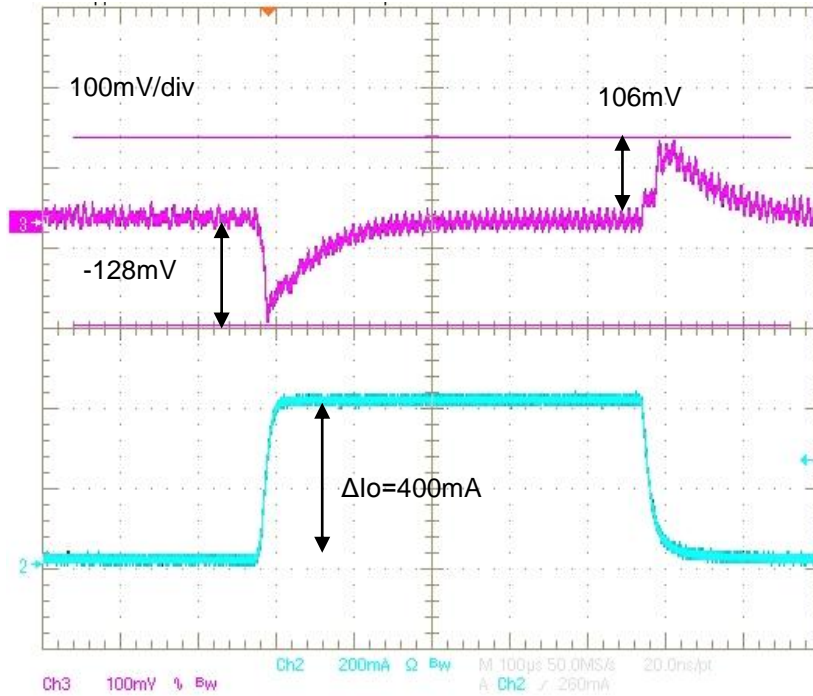

Vin=5.0V, Vout=3.3V

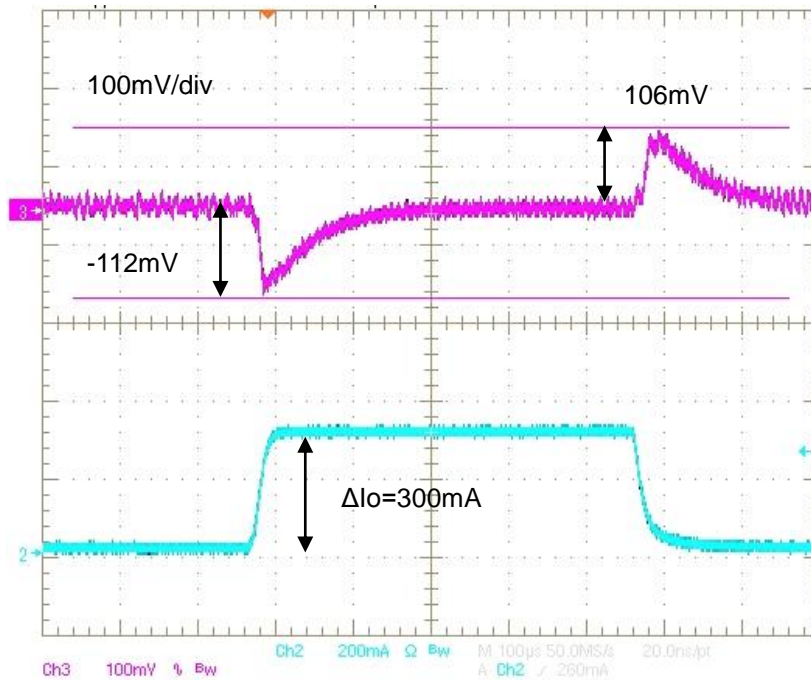

10. Reliability Tests

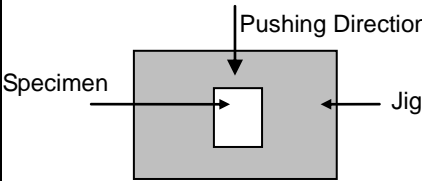
No.	Items	Specifications	Test Methods	QTY	Result (NG)	
1	Vibration Resistance	Appearance : No severe damages	Solder specimens on the testing jig (glass fluorine boards) shown in appended Fig.1 by a Pb free solder. The soldering shall be done either by iron or reflow and be conducted with care so that the soldering is uniform and free of defect such as by heat shock. Frequency : 10~2000 Hz Acceleration : 196 m/s ² Direction : X,Y,Z 3 axis Period : 2 h on each direction Total 6 h.	18	G (0)	
2	Deflection		Solder specimens on the testing jig (glass epoxy boards) shown in appended Fig.2 by a Pb free solder. The soldering shall be done either by iron or reflow and be conducted with care so that the soldering is uniform and free of defect such as by heat shock. Deflection : 1.6mm	18	G (0)	
3	Soldering strength (Push Strength)	9.8 N Minimum	Solder specimens onto test jig shown below. Apply pushing force at 0.5mm/s until electrode pads are peeled off or ceramics are broken. Pushing force is applied to longitudinal direction. 	18	G (0)	
4	Solderability of Termination	75% of the terminations is to be soldered evenly and continuously.	Immerse specimens first an ethanol solution of rosin, then in a Pb free solder solution for 3±0.5 sec. at 245±5 °C. Preheat : 150 °C, 60 sec. Solder Paste : Sn-3.0Ag-0.5Cu Flux : Solution of ethanol and rosin (25 % rosin in weight proportion)	18	G (0)	
5	Resistance to Soldering Heat (Reflow)	Appearance Electrical specifications	No severe damages Satisfy specifications listed in paragraph 6-2.	Preheat Temperature : 150-180 °C Preheat Period : 90+/-30 sec. High Temperature : 220 °C High Temp. Period : 20sec. Peak Temperature : 260+5/-0 °C Specimens are soldered twice with the above condition, and then kept in room condition for 24 h before measurements.	18	G (0)

No.	Items	Specifications	Test Methods	QTY	Result (NG)										
6	High Temp. Exposure	Appearance Electrical specifications	No severe damages Satisfy specifications listed in paragraph 6-2.	Temperature: 85±2 °C Period: 1000+48/-0 h Room Condition: 2~24h	18	G (0)									
7	Temperature Cycle			Condition: 100 cycles in the following table	18	G (0)									
<table border="1"> <thead> <tr> <th>Step</th> <th>Temp(°C)</th> <th>Time(min)</th> </tr> </thead> <tbody> <tr> <td>1</td> <td>Min. Operating Temp.+0/-3</td> <td>30±3</td> </tr> <tr> <td>2</td> <td>Max. Operating Temp.+3/-0</td> <td>30±3</td> </tr> </tbody> </table>				Step			Temp(°C)	Time(min)	1	Min. Operating Temp.+0/-3	30±3	2	Max. Operating Temp.+3/-0	30±3	
Step	Temp(°C)			Time(min)											
1	Min. Operating Temp.+0/-3			30±3											
2	Max. Operating Temp.+3/-0			30±3											
8	Humidity (Steady State)	Temperature: 85±2 °C Humidity: 80~90%RH Period: 1000+48/-0 h Room Condition: 2~24h	18	G (0)											
9	Low Temp. Exposure	Temperature: -40±2 °C Period: 1000+48/-0 h Room Condition: 2~24h	18	G (0)											
10	ESD(Machine Model)	C: 200pF, R: 0Ω TEST Voltage : +/-100V Number of electric discharges: 1	5	G (0)											
11	ESD(Human Body Model)	C: 100pF, R: 1500Ω TEST Voltage : +/-1000V Number of electric discharges: 1	5	G (0)											

Fig.1

Land Pattern

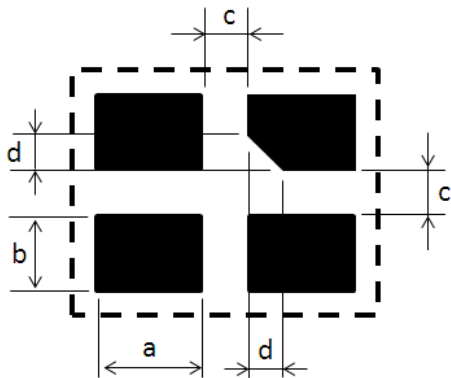

Unit: mm

Symbol	Dimensions
a	0.85
b	0.60
c	0.5
d	0.2

•Reference purpose only.

Fig.2
Testing board

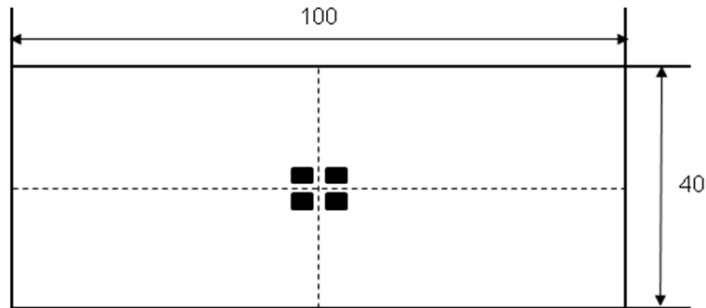

Unit : mm

■ : Land pattern is same as figure 1
Glass-fluorine board $t=1.6\text{mm}$
Copper thickness over $35\ \mu\text{m}$

Mounted situation

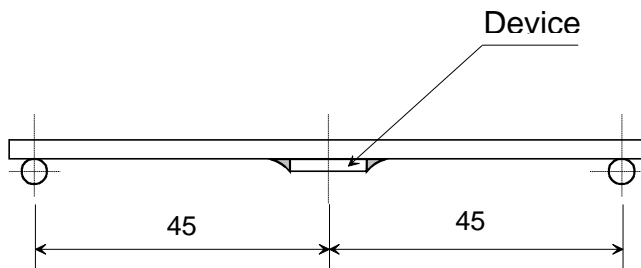

Unit : mm

Test method

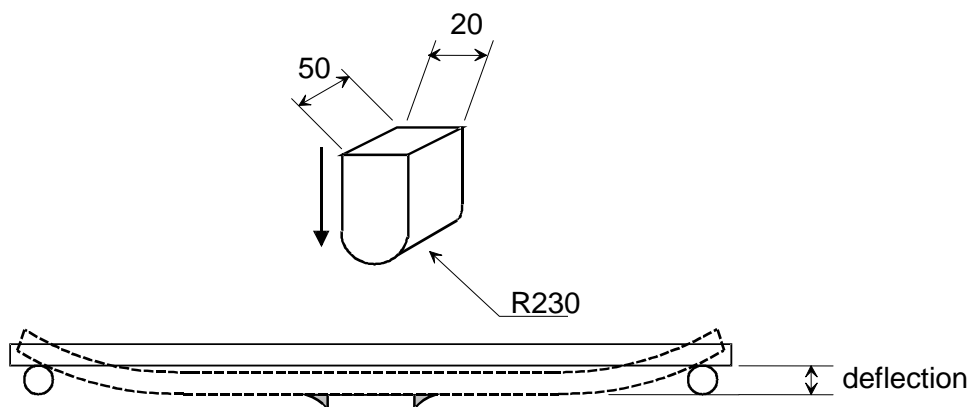

Unit : mm

11. Tape and Reel Packing

1) Dimensions of Tape (Plastic tape)

Unit: mm

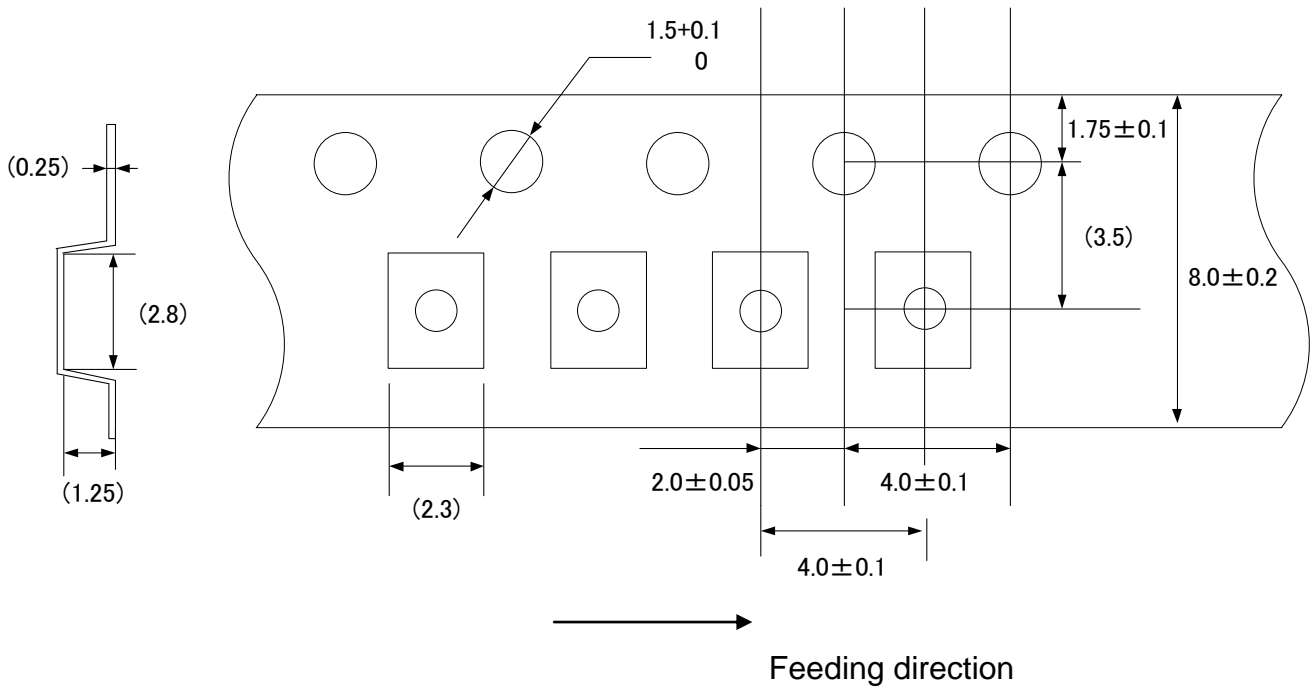

2) Dimensions of Reel

Unit: mm

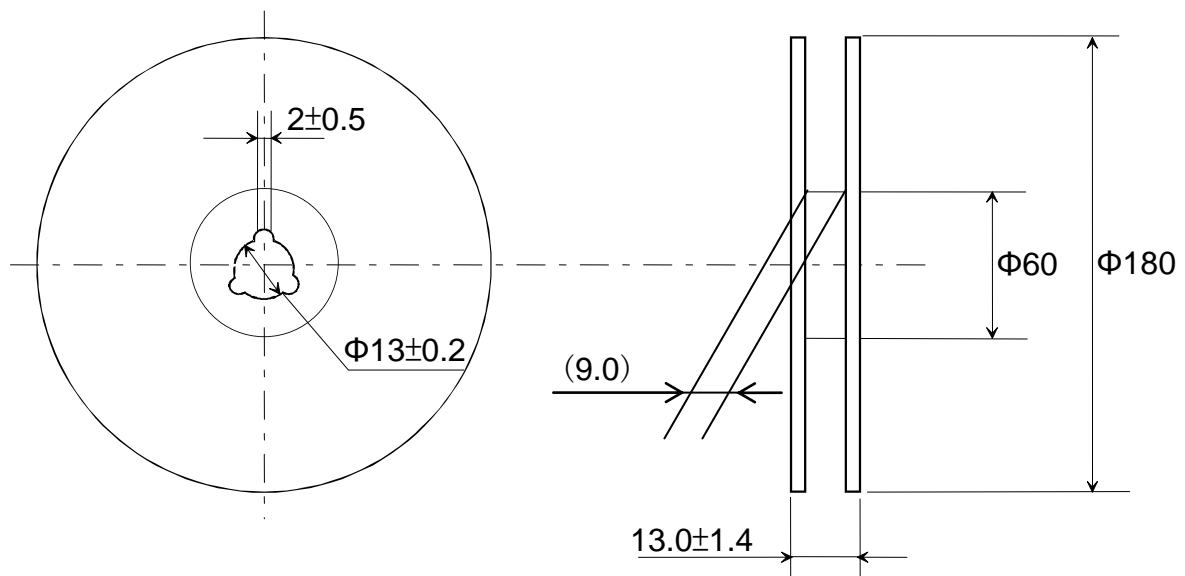

3) Taping Diagrams

- [1] Feeding Hole : As specified in (1)
- [2] Hole for chip : As specified in (1)
- [3] Cover tape : 50um in thickness
- [4] Base tape : As specified in (1)

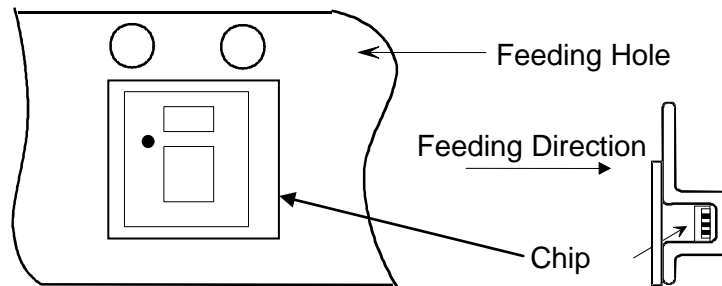
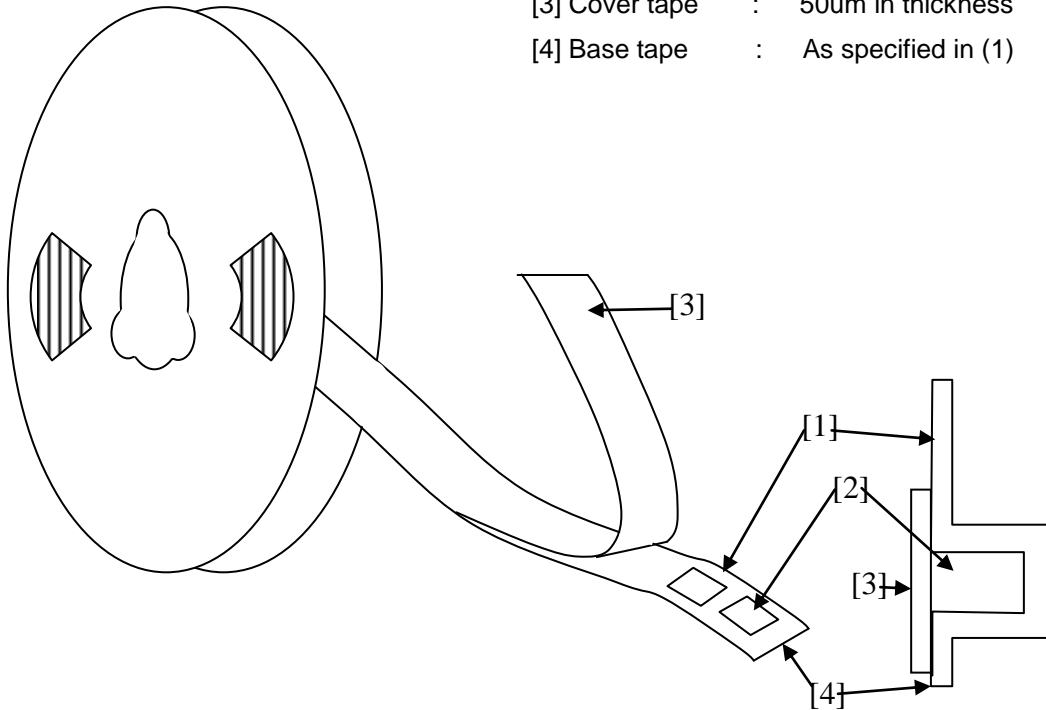

4) Leader and Tail tape

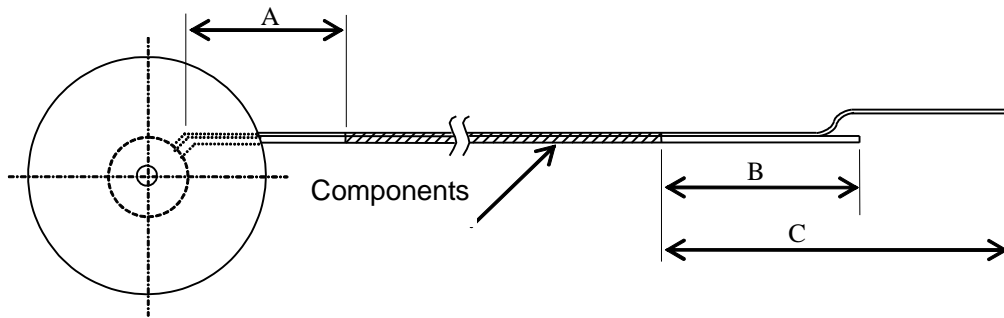

Symbol	Items	Ratings(mm)
A	No components at trailer	min 160
B	No components at leader	min 100
C	Whole leader	min 400

5) The tape for chips are wound clockwise and the feeding holes are to the right side as the tape is pulled toward the user.

6) Packaging unit: 3,000 pcs./ reel

7) Material : Base Tape ... Plastic
 Reel ... Plastic
 Antistatic coating for both base tape and reel

8) Peeling of force

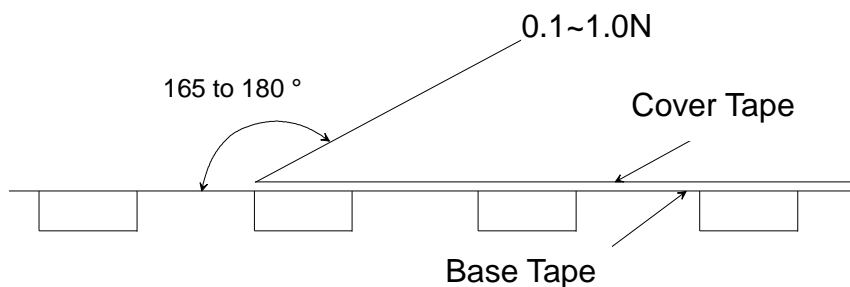

NOTICE

1. Storage Conditions:

To avoid damaging the solderability of the external electrodes, be sure to observe the following points.

- Store products where the ambient temperature is 15 to 35 °C and humidity 45 to 75% RH.
(Packing materials, In particular, may be deformed at the temperature over 40 °C.).
- Store products in non corrosive gas (Cl₂, NH₃, SO₂, NO_x, etc.).
- Stored products should be used within 6 months of receipt. Solderability should be verified if this period is exceeded

This product is applicable to MSL1 (Based on IPC/JEDEC J-STD-020)

2. Handling Conditions:

Be careful in handling or transporting the product. Excessive stress or mechanical shock may damage the product because of the nature of ceramics structure.

Do not touch the product, especially the terminals, with bare hands. Doing so may result in poor solderability.

3. Standard PCB Design (Land Pattern and Dimensions):

All the ground terminals should be connected to ground patterns. Furthermore, the ground pattern should be provided between IN and OUT terminals. Please refer to the specifications for the standard land dimensions.

The recommended land pattern and dimensions are shown for a reference purpose only. Electrical, mechanical and thermal characteristics of the product shall depend on the pattern design and material / thickness of the PCB. Therefore, be sure to check the product performance in the actual set. When using underfill materials, be sure to check the mechanical characteristics in the actual set.

4. Soldering Conditions:

Soldering is allowed up through 2 times.

Carefully perform preheating : ΔT less than 130 °C.

When products are immersed in solvent after mounting, pay special attention to maintain the temperature difference within 100 °C. Soldering must be carried out by the above mentioned conditions to prevent products from damage. Contact Murata before use if concerning other soldering conditions.

Reflow soldering standard conditions (example)

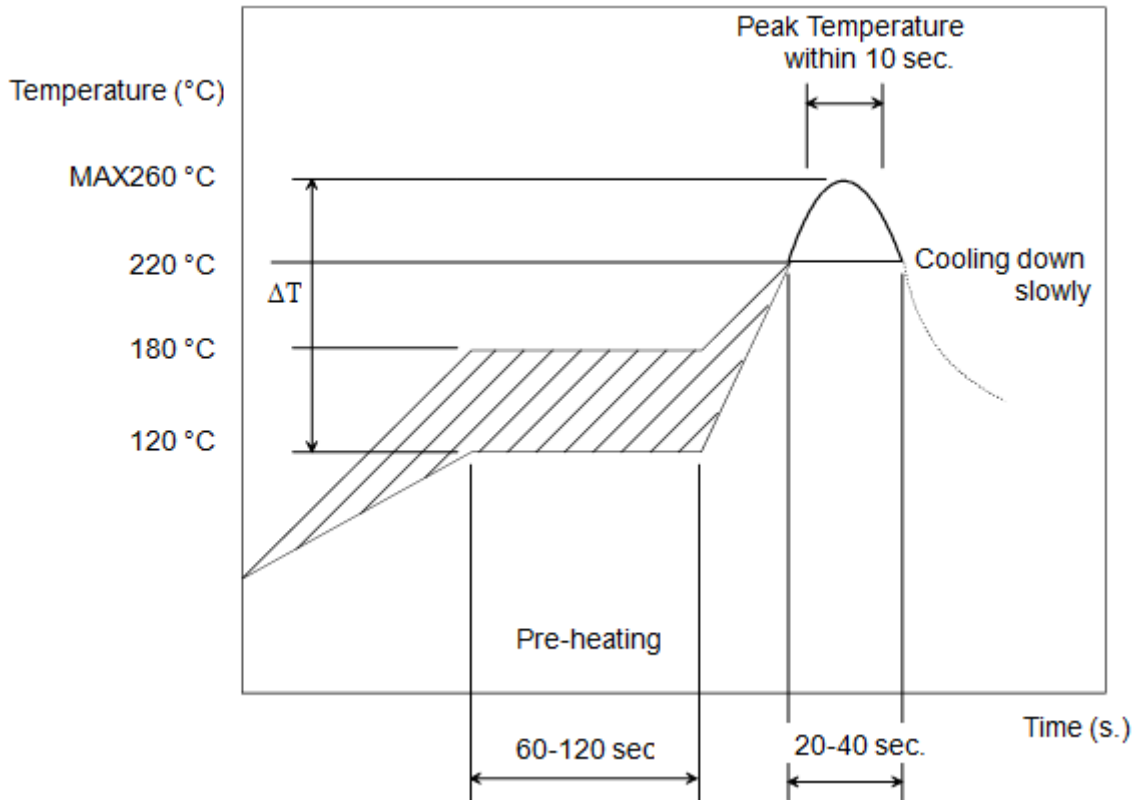

Use rosin type flux or weakly active flux with a chlorine content of 0.2 wt % or less.

5. Cleaning Conditions:

The product is not designed to be cleaned after soldering.

6. Operational Environment Conditions:

Products are designed to work for electronic products under normal environmental conditions (ambient temperature, humidity and pressure). Therefore, products have no problems to be used under the similar conditions to the above-mentioned. However, if products are used under the following circumstances, it may damage products and leakage of electricity and abnormal temperature may occur.

- In an atmosphere containing corrosive gas (Cl₂, NH₃, SO_x, NO_x etc.).
- In an atmosphere containing combustible and volatile gases.
- In a dusty environment.
- Direct sunlight
- Water splashing place.
- Humid place where water condenses.
- In a freezing environment.

If there are possibilities for products to be used under the preceding clause, consult with Murata before actual use.

If static electricity is added to this product, degradation and destruction may be produced.

Please use it after consideration enough so that neither static electricity nor excess voltage is added at the time of an assembly and measurement.

If product malfunctions may result in serious damage, including that to human life, sufficient fail-safe measures must be taken, including the following:

- (1) Installation of protection circuits or other protective device to improve system safety
- (2) Installation of redundant circuits in the case of single-circuit failure

7. Input Power Capacity:

Products shall be used in the input power capacity as specified in this specifications.

Inform Murata beforehand, in case that the components are used beyond such input power capacity range .

8. Limitation of Applications:

The products are designed and produced for application in ordinary electronic equipment (AV equipment, OA equipment, telecommunication, etc). If the products are to be used in devices requiring extremely high reliability following the application listed below, you should consult with the Murata staff in advance.

- Aircraft equipment.
- Aerospace equipment
- Undersea equipment.
- Power plant control equipment.
- Medical equipment.
- Transportation equipment (vehicles, trains, ships, etc.).
- Automobile equipment which includes the genuine brand of car manufacture, car factory-installed option and dealer-installed option.
- Traffic signal equipment.
- Disaster prevention / crime prevention equipment.
- Data-proccession equipment.
- Application which malfunction or operational error may endanger human life and property of assets.
- Application which related to occurrence the serious damage
- Application of similar complexity and/ or reliability requirements to the applications listed in the above.

Note:

Please make sure that your product has been evaluated and confirmed against your specifications when our product is mounted to your product.

Product specifications are subject to change or our products in it may be discontinued without advance notice.

This catalog is for reference only and not an official product specification document, therefore, please review and approve our official product specification before ordering this product.