

具有总线唤醒功能的低功率网络控制器局域网络 (CAN) 收发器

 查询样品: [SN65HVD1040-HT](#)

特性

- 改进的针对 **TJA1040** 的简易替换器件
- **±12 kV** 静电放电 (ESD) 保护
- 具有总线唤醒功能的低电流待机模式: 典型值 **5 μA**
- **-27 V** 至 **40 V** 的总线故障保护
- 耐用的拆分式引脚总线稳定性
- 主计时功能
- 热关断已被移除
- 加电/断电无毛刺脉冲总线输入和输出
 - 具有低 V_{CC} 的高输入阻抗
 - 电源循环期间单片输出
- **DeviceNet** 供应商标识号 (ID) #806

支持极端温度应用

- 受控基线
- 一个组装/测试场所
- 一个制造场所
- 可在 **-55°C/210°C** 的极端温度范围内工作 ⁽¹⁾
- 产品生命周期有所延长
- 拓展的产品变更通知
- 产品可追溯性
- 德州仪器的高温产品运用了高度优化的硅片 (芯片) 解决方案, 此类解决方案在设计与工艺方面均有所强化, 以在扩展的温度范围内实现性能的最大化。在最大额定温度下, 所有器件可连续正常运行 **1000** 小时。

应用范围

- 潜孔钻进
- 高温环境
- 振动/模式分析
- 多通道数据采集
- 声学/动态应变仪
- 压力传感器

⁽¹⁾ 可定制工作温度范围

说明

SN65HVD1040 满足或者超过 ISO 11898 标准中规定的对于采用控制器局域网络 (CAN) 的应用所要求的技术规范。作为 CAN 收发器, 这些器件能够为信号传输速率高达每秒钟 1 兆比特 (Mbps) 的 CAN 控制器提供差分传输和接收能力。 ⁽²⁾

被设计运行在恶劣环境下, 此器件在总线和拆分引脚上特有 **±12 kV ESD** 保护, 以及交叉线, 过压保护和 **-27 V** 至 **40 V** 的失地保护, 一个 **-12 V** 至 **12 V** 的共模范围, 并且根据 ISO 7637 标准能承受从 **-200 V** 到 **200 V** 的电压瞬变。

STB 输入 (引脚8) 用于在两个不同的运行模式间做出选择; 即高速模式或者低速模式。通过将 STB 引脚接地来选择高速运行模式。

如果一个高逻辑电平被加在 SN65HVD1040 的 STB 引脚上, 此器件进入一个低功率总线监控待机模式。当 SN65HVD1040 运行在低功率总线监控待机模式下的时候, 总线上一个大于 **5 μs** 的显性位由总线监控电路传递到接收器输出。然后, 当此器件需要向总线传输数据时, 此本地协议控制器可以重新激活此器件。

SN65HVD1040 内的主计时电路在硬件或者软件故障期间防止此驱动器阻塞网络通信。此计时电路由 TXD (引脚1) 上的下降沿触发。如果在此电路的计时常数过期前没有发现上升沿, 此驱动器将被禁用。此电路被 TXD 上的下一个上升沿复位。

⁽²⁾ 一条线路的信号传输速率就是电压瞬变的次数, 即每秒钟单位 bps (每秒比特数)。



Please be aware that an important notice concerning availability, standard warranty, and use in critical applications of Texas Instruments semiconductor products and disclaimers thereto appears at the end of this data sheet.

SN65HVD1040 上可具有拆分 (SPLIT) 输出 (引脚 5)，在拆分式终端网络中，此输出可作为一个 $V_{CC}/2$ 共模总线偏置电压。

SN65HVD1040 额定工作温度 -55°C 至 210°C 。

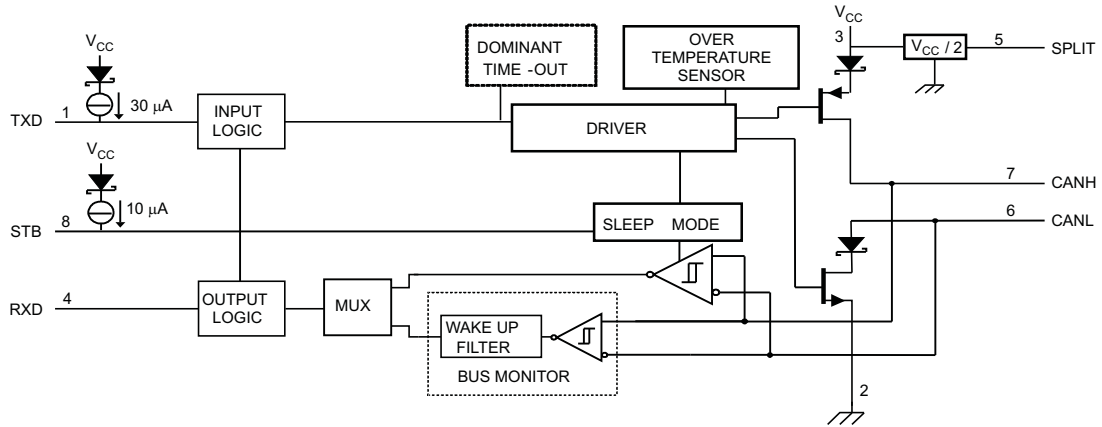



This integrated circuit can be damaged by ESD. Texas Instruments recommends that all integrated circuits be handled with appropriate precautions. Failure to observe proper handling and installation procedures can cause damage.

ESD damage can range from subtle performance degradation to complete device failure. Precision integrated circuits may be more susceptible to damage because very small parametric changes could cause the device not to meet its published specifications.

Table 1. ORDERING INFORMATION⁽¹⁾

T _J	PACKAGE	ORDERABLE PART NUMBER	TOP-SIDE MARKING
-55°C to 210°C	KGD (bare die)	SN65HVD1040SKGD3	NA
	HKQ	SN65HVD1040SHKQ	HVD1040SHKQ
-55°C to 175°C	D	SN65HVD1040HD	H1040

(1) For the most current package and ordering information, see the Package Option Addendum at the end of this document, or see the TI Web site at www.ti.com.

BARE DIE INFORMATION

DIE THICKNESS	BACKSIDE FINISH	BACKSIDE POTENTIAL	BOND PAD METALLIZATION COMPOSITION	BOND PAD THICKNESS
15 mils.	Silicon with backgrind	Floating	CuNiPd	15 microns

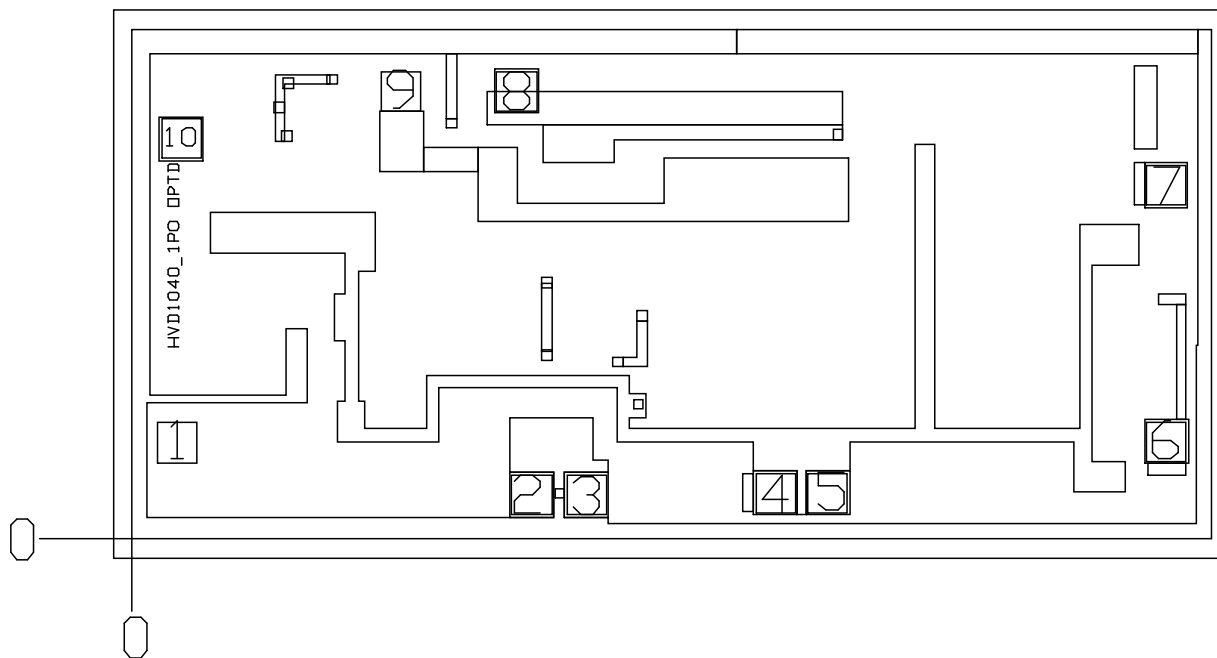

Table 2. BOND PAD COORDINATES (μm)

DESCRIPTION	PAD NUMBER	X MIN	Y MIN	X MAX	Y MAX	PAD SIZE X	PAD SIZE Y
TXD	1	53.64	162	137.7	246.06	84.06	84.06
GND	2	804.06	50.85	888.12	134.91	84.06	84.06
GND	3	920.07	50.85	1004.13	134.91	84.06	84.06
Vcc	4	1320.21	54.18	1404.27	138.24	84.06	84.06
Vcc	5	1431.09	54.18	1515.15	138.24	84.06	84.06
RXD	6	2148.75	164.34	2232.81	248.4	84.06	84.06
SPLIT	7	2147.4	707.49	2231.46	791.55	84.06	84.06
CANL	8	771.93	907.38	855.99	991.44	84.06	84.06
CANH	9	527.31	907.38	611.37	991.44	84.06	84.06
STB	10	62.28	806.13	146.34	890.19	84.06	84.06

ABSOLUTE MAXIMUM RATINGS⁽¹⁾

		VALUE	
V _{CC}	Supply voltage ⁽²⁾	–0.3 V to 7 V	
V _{I(bus)}	Voltage range at any bus terminal (CANH, CANL, SPLIT)	–27 V to 40 V	
I _{O(OUT)}	Receiver output current	–20 mA to 20 mA	
Voltage input, transient pulse ⁽³⁾ , (CANH, CANL, SPLIT)		–200 V to 200 V	
ESD	IEC Contact Discharge (IEC 61000-4-2)	Bus terminals vs GND ±6 kV	
	Human body model	JEDEC Standard 22, Test Method A114-C.01	Bus terminals vs GND ±12 kV All pins ±4 kV
	Field-Induced-Charged Device Model	JEDEC Standard 22, Test Method C101	All pins ±1 kV
	Machine model	ANSI/ESDS5.2-1996	±200 V
IEC		Bus terminals vs GND ±6 kV	
V _I	Voltage input range (TXD, STB)	–0.5 V to 6 V	
T _J	Junction temperature	–55°C to 210°C	

- (1) Stresses beyond those listed under "absolute maximum ratings" may cause permanent damage to the device. These are stress ratings only and functional operation of the device at these or any other conditions beyond those indicated under "recommended operating conditions" is not implied. Exposure to absolute-maximum-rated conditions for extended periods may affect device reliability.
- (2) All voltage values, except differential I/O bus voltages, are with respect to network ground terminal.
- (3) Tested in accordance with ISO 7637, test pulses 1, 2, 3a, 3b, 5, 6 & 7.

THERMAL CHARACTERISTICS FOR HKQ PACKAGE

over operating free-air temperature range (unless otherwise noted)

PARAMETER		MIN	TYP	MAX	UNIT
θ _{JC}	Junction-to-case thermal resistance	to ceramic side of case		5.7	°C/W
		to top of case lid (metal side of case)		13.7	

THERMAL INFORMATION FOR D PACKAGE

THERMAL METRIC ⁽¹⁾		SN65HVD1040	UNITS
		D	
		8 PINS	
θ _{JA}	Junction-to-ambient thermal resistance ⁽²⁾	91.9	°C/W
θ _{JCtop}	Junction-to-case (top) thermal resistance ⁽³⁾	39.9	
θ _{JB}	Junction-to-board thermal resistance ⁽⁴⁾	40.6	
ψ _{JT}	Junction-to-top characterization parameter ⁽⁵⁾	3.9	
ψ _{JB}	Junction-to-board characterization parameter ⁽⁶⁾	39.6	
θ _{JCbot}	Junction-to-case (bottom) thermal resistance ⁽⁷⁾	N/A	

- (1) For more information about traditional and new thermal metrics, see the *IC Package Thermal Metrics* application report, [SPRA953](#).
- (2) The junction-to-ambient thermal resistance under natural convection is obtained in a simulation on a JEDEC-standard, high-K board, as specified in JESD51-7, in an environment described in JESD51-2a.
- (3) The junction-to-case (top) thermal resistance is obtained by simulating a cold plate test on the package top. No specific JEDEC-standard test exists, but a close description can be found in the ANSI SEMI standard G30-88.
- (4) The junction-to-board thermal resistance is obtained by simulating in an environment with a ring cold plate fixture to control the PCB temperature, as described in JESD51-8.
- (5) The junction-to-top characterization parameter, ψ_{JT}, estimates the junction temperature of a device in a real system and is extracted from the simulation data for obtaining θ_{JA}, using a procedure described in JESD51-2a (sections 6 and 7).
- (6) The junction-to-board characterization parameter, ψ_{JB}, estimates the junction temperature of a device in a real system and is extracted from the simulation data for obtaining θ_{JA}, using a procedure described in JESD51-2a (sections 6 and 7).
- (7) The junction-to-case (bottom) thermal resistance is obtained by simulating a cold plate test on the exposed (power) pad. No specific JEDEC standard test exists, but a close description can be found in the ANSI SEMI standard G30-88.

RECOMMENDED OPERATING CONDITIONS

		T _J = -55°C to 125°C			T _J = -55°C to 175°C			T _J = -55°C to 210°C			UNIT
		MIN	NOM	MAX	MIN	NOM	MAX	MIN	NOM	MAX	
V _{CC}	Supply voltage	4.75		5.25	4.75		5.25	4.75		5.25	V
V _I or V _{IC}	Voltage at any bus terminal (separately or common mode)	-12 ⁽¹⁾		12	-12 ⁽¹⁾		12	-12 ⁽¹⁾		12	V
V _{IH}	High-level input voltage	2		5.25	2		5.25	2		5.25	V
V _{IL}	Low-level input voltage	0		0.8	0		0.8	0		0.8	V
V _{ID}	Differential input voltage	-6		6	-6		6	-6		6	V
I _{OH}	High-level output current	Driver		-70		-70				-70	mA
		Receiver		-2		-2			-2		
I _{OL}	Low-level output current	Driver		70		70				70	mA
		Receiver		2		2			2		
t _{SS}	Maximum pulse width to remain in standby			0.7			0.7			0.7	μs
T _J	Junction temperature	-55		125	-55		175	-55		210	°C

(1) The algebraic convention, in which the least positive (most negative) limit is designated as minimum is used in this data sheet.

SUPPLY CURRENT

over operating free-air temperature range (unless otherwise noted)

PARAMETER		TEST CONDITIONS	T _J = -55°C to 125°C			T _J = -55°C to 175°C			T _J = -55°C to 210°C			UNIT
			MIN	TYP	MAX	MIN	TYP	MAX	MIN	TYP	MAX	
I _{CC}	Supply current, V _{CC}	Dominant V _I = 0 V, 60 Ω Load, STB at 0 V		50	70		50	70		50	70	mA
		Recessive V _I = V _{CC} , STB at 0 V		6	10		6	10		6	10	
		Standby STB at V _{CC} , V _I = V _{CC}		5	12		5	20		5	50	μA

DEVICE SWITCHING CHARACTERISTICS

over recommended operating conditions (unless otherwise noted)

PARAMETER		TEST CONDITIONS	T _J = -55°C to 125°C			T _J = -55°C to 175°C			T _J = -55°C to 210°C			UNIT
			MIN	TYP	MAX	MIN	TYP	MAX	MIN	TYP	MAX	
t _{loop1}	Total loop delay, driver input to receiver output, Recessive to Dominant	STB at 0 V, See Figure 10	90		230	90		325	90		450	ns
t _{loop2}	Total loop delay, driver input to receiver output, Dominant to Recessive		90		230	90		325	90		450	

DRIVER ELECTRICAL CHARACTERISTICS

over recommended operating conditions (unless otherwise noted)

PARAMETER		TEST CONDITIONS	T _J = -55°C to 125°C			T _J = -55°C to 175°C			T _J = -55°C to 210°C			UNIT		
			MIN	TYP ⁽¹⁾	MAX	MIN	TYP ⁽¹⁾	MAX	MIN	TYP ⁽¹⁾	MAX			
V _{O(D)}	Bus output voltage (Dominant)	CANH	V _I = 0 V, STB at 0 V, R _L = 60 Ω, See Figure 2 and Figure 3		2.9	3.4	4.5	2.9	3.4	4.6	2.9	3.4	4.6	V
		CANL			0.8		1.75	0.8		1.75	0.8		1.75	
V _{O(R)}	Bus output voltage (Recessive)		V _I = 3 V, STB at 0 V, See Figure 2 and Figure 3		2	2.5	3	2	2.5	3	2	2.5	3	V
V _O	Bus output voltage (Standby)		R _L = 60 Ω, STB at V _{CC} , See Figure 2 and Figure 3		-0.1		0.1	-0.125		0.125	-0.15		0.15	V
V _{OD(D)}	Differential output voltage (Dominant)		V _I = 0 V, R _L = 60 Ω, STB at 0 V, See Figure 2 and Figure 3, and Figure 4		1.5		3	1.5		3	1.5		3	V
			V _I = 0 V, R _L = 45 Ω, STB at 0 V, See Figure 2 and Figure 3		1.4		3	1.4		3	1.4		3	
V _{SYM}	Output symmetry (Dominant or Recessive) [V _{O(CANH)} + V _{O(CANL)}]		STB at 0 V, See Figure 3 and Figure 14		0.9xV _{CC}	V _{CC}	1.1xV _C	0.9xV _{CC}	V _{CC}	1.1xV _C	0.9xV _C	V _{CC}	1.2xV _{CC}	V
V _{OD(R)}	Differential output voltage (Recessive)		V _I = 3 V, R _L = 60 Ω, STB at 0 V, See Figure 2 and Figure 3		-0.012		0.012	-0.014		0.017	-0.015		0.02	V
			V _I = 3 V, STB at 0 V, No Load		-0.5		0.05	-0.5		0.225	-0.75		0.8	
V _{OC(D)}	Common-mode output voltage (Dominant)		STB at 0 V, See Figure 9		2	2.3	3	2	2.3	3	2	2.3	3.1	V
V _{OC(pp)}	Peak-to-peak common-mode output voltage					0.3			0.3			0.3		
I _{IH}	High-level input current, TXD input		V _I at V _{CC}		-2		2	-3		3	-3		3	μA
I _{IL}	Low-level input current, TXD input		V _I at 0 V		-50		-10	-50		-10	-50		-10	μA
I _{O(off)}	Power-off TXD Leakage current		V _{CC} at 0 V, TXD at 5 V				1			180			600	μA
I _{OS(ss)}	Short-circuit steady-state output current		V _{CANH} = -12 V, CANL Open, See Figure 13		-120	-72		-120	-72		-130	-72		mA
			V _{CANH} = 12 V, CANL Open, See Figure 13			0.36	1		0.36	1		0.36	1.1	
			V _{CANL} = -12 V, CANH Open, See Figure 13		-1	-0.5		-1	-0.5		-1.1	-0.5		
			V _{CANL} = 12 V, CANH Open, See Figure 13			71	120		71	120		71	130	
C _O	Output capacitance		See Input capacitance to ground in RECEIVER ELECTRICAL CHARACTERISTICS.											

(1) All typical values are at 25°C with a 5-V supply.

DRIVER SWITCHING CHARACTERISTICS

over recommended operating conditions (unless otherwise noted)

PARAMETER	TEST CONDITIONS	$T_J = -55^{\circ}\text{C to } 125^{\circ}\text{C}$			$T_J = -55^{\circ}\text{C to } 175^{\circ}\text{C}$			$T_J = -55^{\circ}\text{C to } 210^{\circ}\text{C}$			UNIT			
		MIN	TYP	MAX	MIN	TYP	MAX	MIN	TYP	MAX				
t_{PLH}	Propagation delay time, low-to-high-level output	25	65	120	25	65	175	25	65	250	ns			
t_{PHL}	Propagation delay time, high-to-low-level output	25	45	120	25	45	175	25	45	250				
$t_{sk(p)}$	Pulse skew ($t_{PHL} - t_{PLH}$)	STB at 0 V, See Figure 5			25	25		25						
t_r	Differential output signal rise time	25			25			25						
t_f	Differential output signal fall time	50			50			50						
t_{en}	Enable time from silent mode to dominant	See Figure 8			11			14.5			18	μs		
t_{dom}	Dominant time-out	See Figure 11			300	450	700	300	450	700	300	450	700	μs

RECEIVER ELECTRICAL CHARACTERISTICS

over recommended operating conditions (unless otherwise noted)

PARAMETER		TEST CONDITIONS	T _J = -55°C to 125°C			T _J = -55°C to 175°C			T _J = -55°C to 210°C			UNIT
			MIN	TYP	MAX	MIN	TYP	MAX	MIN	TYP	MAX	
V _{IT+}	Positive-going input threshold voltage	STB at 0 V, See Table 3		800	900		800	900		800	900	mV
V _{IT-}	Negative-going input threshold voltage		500	650		500	650		500	650		
V _{hys}	Hysteresis voltage (V _{IT+} – V _{IT-})	STB at V _{CC}	100	125		70	125		70	125		
V _{IT}	Input threshold voltage	Standby mode STB at V _{CC}	500		1150	500		1300	400		1350	
V _{OH}	High-level output voltage	I _O = -2 mA, See Figure 7	4	4.6		4	4.6		4	4.6		V
V _{OL}	Low-level output voltage	I _O = 2 mA, See Figure 7		0.2	0.4		0.2	0.5		0.2	0.55	V
I _{I(off)}	Power-off bus input current	CANH or CANL = 5 V, V _{CC} at 0 V, TXD at 0 V			5			15			30	μA
I _{O(off)}	Power-off RXD leakage current	V _{CC} at 0 V, RXD at 5 V			20			30			30	μA
C _I	Input capacitance to ground, (CANH or CANL)	TXD at 3 V, V _I = 0.4 sin(4E6πt) + 2.5 V		20			20			20		pF
C _{ID}	Differential input capacitance	TXD at 3 V, V _I = 0.4 sin(4E6πt)		10			10			10		pF
R _{ID}	Differential input resistance	TXD at 3 V, STD at 0 V	30		80	30		80	30		80	kΩ
R _{IN}	Input resistance, (CANH or CANL)	TXD at 3 V, STD at 0 V	15	30	40	15	30	40	15	30	40	
R _{I(m)}	Input resistance matching [1 – (R _{IN(CANH)} / R _{IN(CANL)})] x 100%	V _{CANH} = V _{CANL}	-3%	0%	3%	-5%	0%	5%	-12%	0%	12%	

RECEIVER SWITCHING CHARACTERISTICS

over recommended operating conditions (unless otherwise noted)

PARAMETER		TEST CONDITIONS	T _J = -55°C to 125°C			T _J = -55°C to 175°C			T _J = -55°C to 210°C			UNIT
			MIN	TYP	MAX	MIN	TYP	MAX	MIN	TYP	MAX	
t _{pLH}	Propagation delay time, low-to-high-level output	STB at 0 V, TXD at 3 V, See Figure 7	60	100	130	60	100	200	60	100	200	ns
t _{pHL}	Propagation delay time, high-to-low-level output		45	70	130	45	70	200	45	70	200	
t _r	Output signal rise time			8			8			8		
t _f	Output signal fall time			8			8			8		
t _{BUS}	Dominant time required on bus for wake-up from standby ⁽¹⁾	STB at V _{CC} Figure 12	0.7		5	1.0		5.1	1.45		5.25	μs

(1) The device under test shall not signal a wake-up condition with dominant pulses shorter than t_{BUS} (min) and shall signal a wake-up condition with dominant pulses longer than t_{BUS} (max). Dominant pulses with a length between t_{BUS} (min) and t_{BUS} (max) may lead to a wake-up.

SPLIT-PIN CHARACTERISTICS

over recommended operating conditions (unless otherwise noted)

PARAMETER		TEST CONDITIONS	T _J = -55°C to 125°C			T _J = -55°C to 175°C			T _J = -55°C to 210°C			UNIT
			MIN	TYP	MAX	MIN	TYP	MAX	MIN	TYP	MAX	
V _O	Output voltage	-500 μA < I _O < 500 μA	0.3xV _{CC}	0.5xV _{CC}	0.7xV _{CC}	0.28xV _{CC}	0.5xV _{CC}	0.7xV _{CC}	0.28xV _C	0.5xV _C	0.7xV _{CC}	V
I _{O(st b)}	Standby mode leakage current	STB at 2 V, -12 V ≤ V _O ≤ 12 V	-5		5	-7		7	-15		15	μA

STB-PIN CHARACTERISTICS

over recommended operating conditions (unless otherwise noted)

PARAMETER	TEST CONDITIONS	T _J = -55°C to 125°C			T _J = -55°C to 175°C			T _J = -55°C to 210°C			UNIT	
		MIN	TYP	MAX	MIN	TYP	MAX	MIN	TYP	MAX		
I _{IH}	High level input current	STB at 2 V	-10		0	-10		0	-10		0	μA
I _{IL}	Low level input current	STB at 0 V	-10		0	-10		0	-10		0	μA

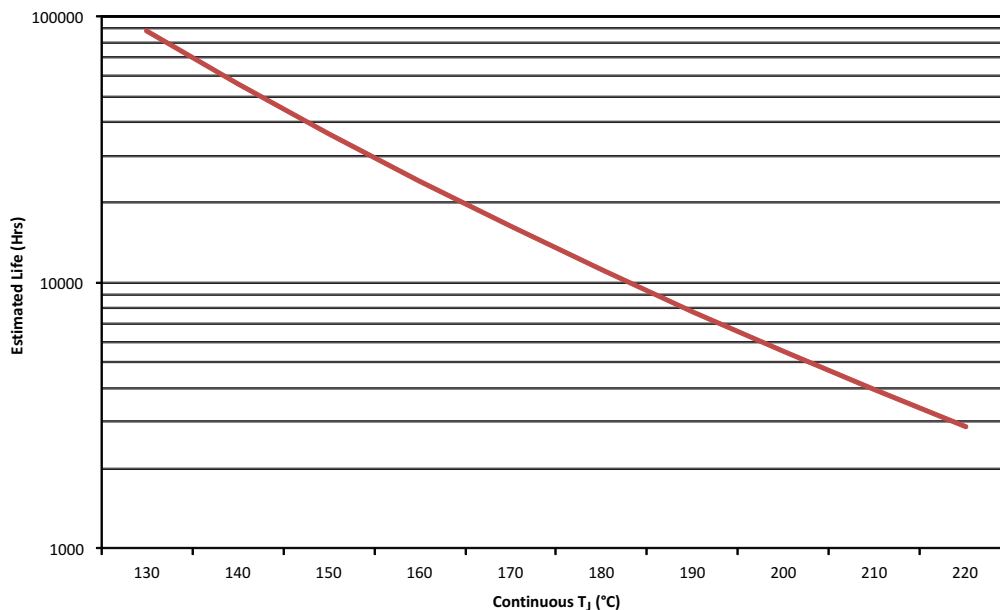

- A. See datasheet for absolute maximum and minimum recommended operating conditions.
- B. Silicon operating life design goal is 10 years at 105°C junction temperature (does not include package interconnect life).
- C. The predicted operating lifetime vs. junction temperature is based on reliability modeling using electromigration as the dominant failure mechanism affecting device wear out for the specific device process and design characteristics.

Figure 1. SN65HVD1040-HT Operating Life Derating Chart

PARAMETER MEASUREMENT INFORMATION

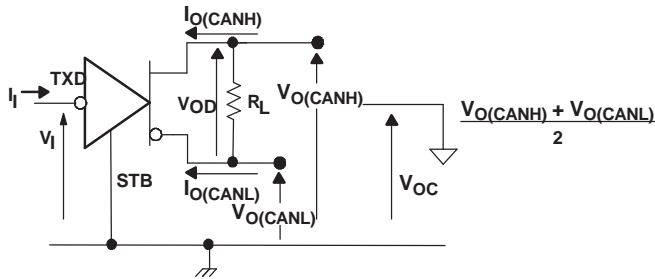

Figure 2. Driver Voltage, Current, and Test Definition

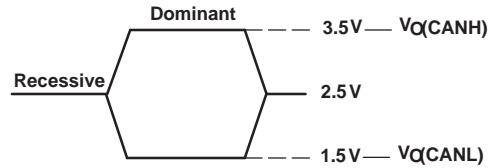

Figure 3. Bus Logic State Voltage Definitions

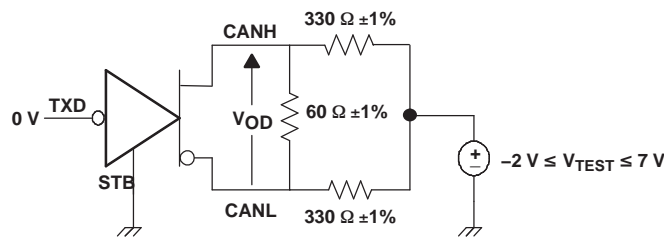

Figure 4. Driver VOD Test Circuit

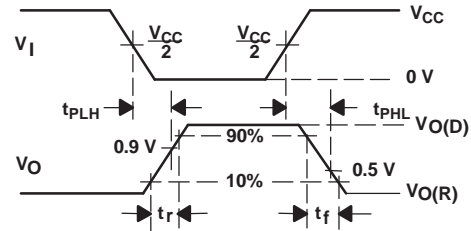
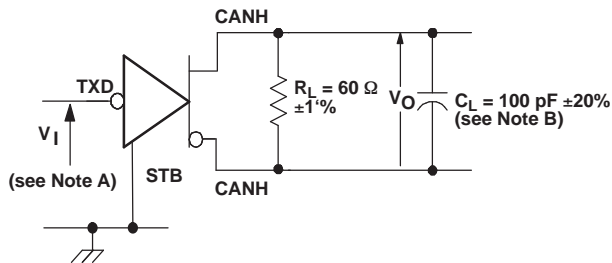

Figure 5. Driver Test Circuit and Voltage Waveforms

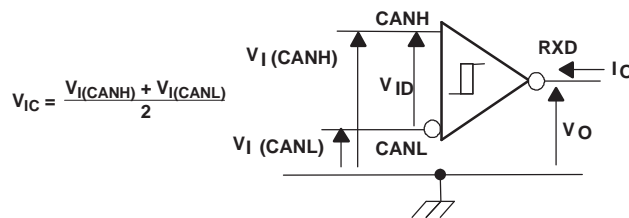
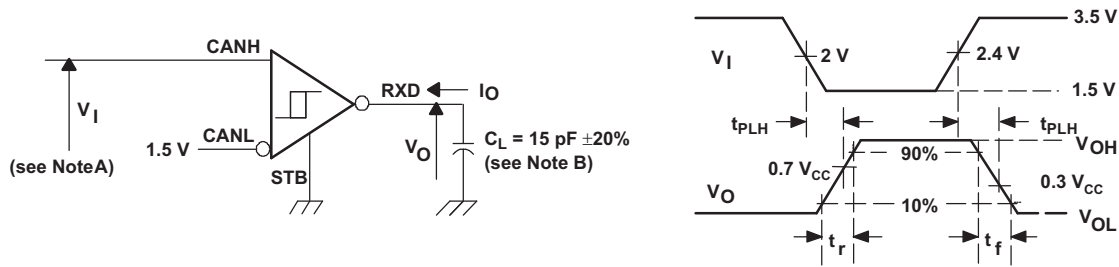

Figure 6. Receiver Voltage and Current Definitions

PARAMETER MEASUREMENT INFORMATION (continued)



- A. The input pulse is supplied by a generator having the following characteristics: PRR ≤ 125 kHz, 50% duty cycle, $t_r \leq 6$ ns, $t_f \leq 6$ ns, $Z_O = 50 \Omega$.
- B. C_L includes instrumentation and fixture capacitance within ±20%.

Figure 7. Receiver Test Circuit and Voltage Waveforms

Table 3. Differential Input Voltage Threshold Test

INPUT			OUTPUT	
V_{CANH}	V_{CANL}	$ V_{ID} $	R	
-11.1 V	-12 V	900 mV	L	V_{OL}
12 V	11.1 V	900 mV	L	
-6 V	-12 V	6 V	L	
12 V	6 V	6 V	L	
-11.5 V	-12 V	500 mV	H	V_{OH}
12 V	11.5 V	500 mV	H	
-12 V	-6 V	6 V	H	
6 V	12 V	6 V	H	
Open	Open	X	H	

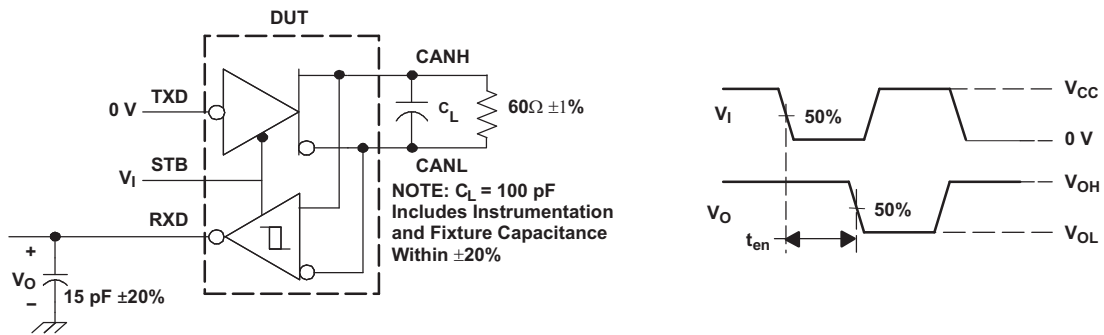
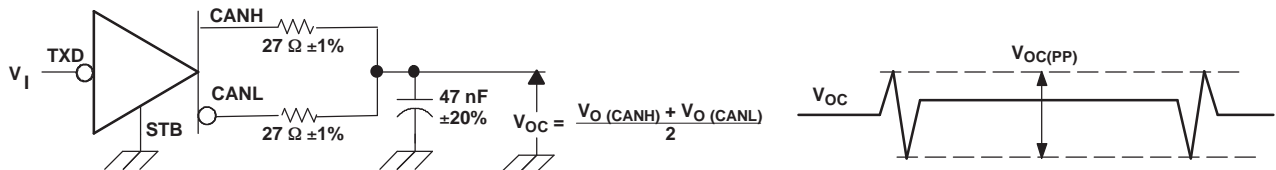
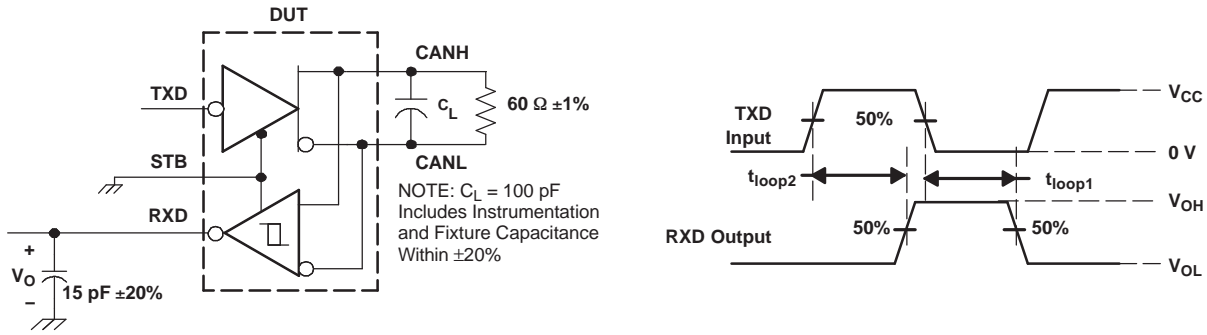

Figure 8. t_{en} Test Circuit and Voltage Waveforms



- A. All V_I input pulses are from 0 V to V_{CC} and supplied by a generator having the following characteristics: t_r or $t_f \leq 6$ ns. Pulse Repetition Rate (PRR) = 125 kHz, 50% duty cycle.

Figure 9. Peak-to-Peak Common Mode Output Voltage Test and Waveform



- A. All V_I input pulses are from 0 V to V_{CC} and supplied by a generator with the following characteristics: t_r or $t_f \leq 6 \text{ ns}$. Pulse Repetition Rate (PRR) = 125 kHz, 50% duty cycle.

Figure 10. t_{loop} Test Circuit and Voltage Waveforms

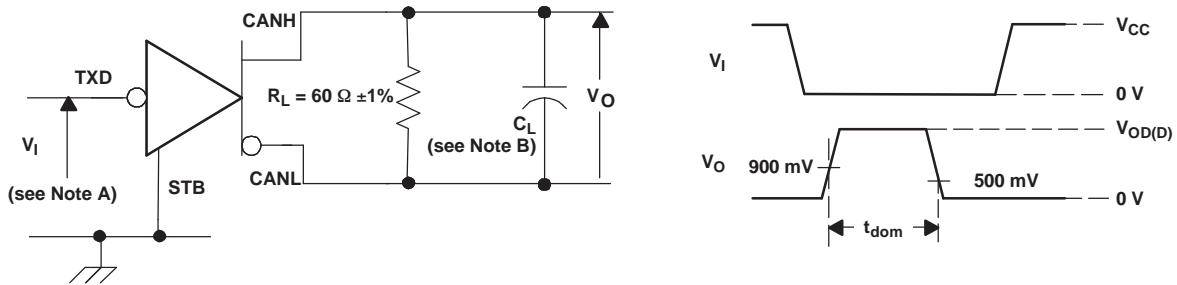

- A. All V_I input pulses are from 0 V to V_{CC} and supplied by a generator with the following characteristics: t_r or $t_f \leq 6 \text{ ns}$. Pulse Repetition Rate (PRR) = 500 Hz, 50% duty cycle.
- B. $C_L = 100 \text{ pF}$ includes instrumentation and fixture capacitance within $\pm 20\%$.

Figure 11. Dominant Time-Out Test Circuit and Waveform

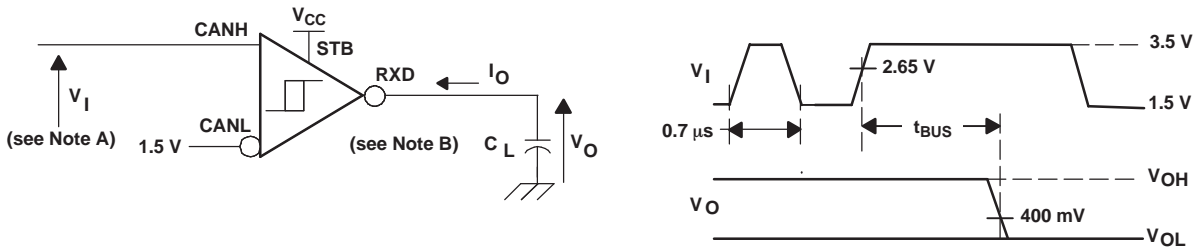

- A. For V_I bit width $\leq 0.7 \mu\text{s}$, $V_O = V_{OH}$. For V_I bit width $\geq 5 \mu\text{s}$, $V_O = V_{OL}$. V_I input pulses are supplied from a generator with the following characteristics; t_r or $t_f \leq 6 \text{ ns}$. Pulse Repetition Rate (PRR) = 50 Hz, 30% duty cycle.
- B. $C_L = 15 \text{ pF}$ includes instrumentation and fixture capacitance within $\pm 20\%$.

Figure 12. t_{BUS} Test Circuit and Waveform

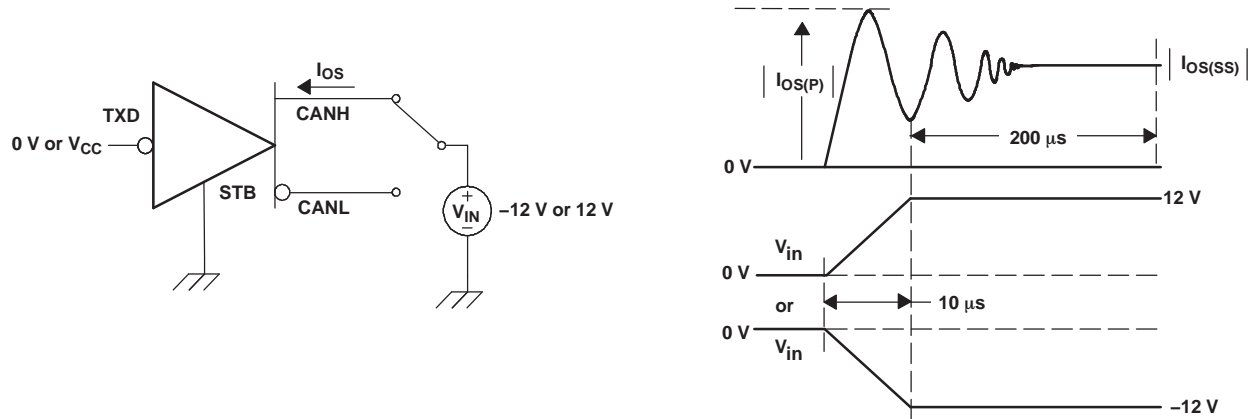

Figure 13. Driver Short-Circuit Current Test and Waveform

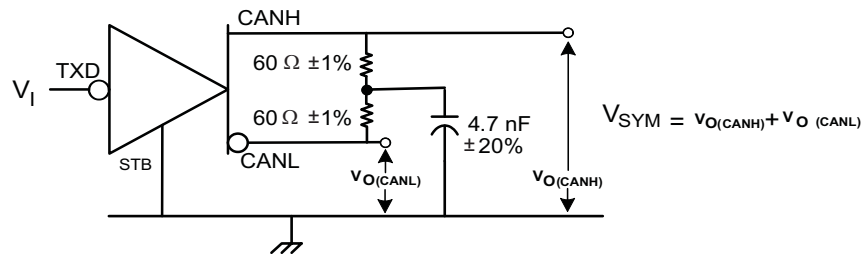

Figure 14. Driver Output Symmetry Test Circuit

DEVICE INFORMATION

Table 4. DRIVER FUNCTION TABLE⁽¹⁾

INPUTS		OUTPUTS		BUS STATE
TXD	STB	CANH	CANL	
L	L	H	L	DOMINANT
H	L	Z	Z	RECESSIVE
Open	X	Z	Z	RECESSIVE
X	H or Open	Z	Z	RECESSIVE

(1) H = high level; L = low level; X = irrelevant; Z = high impedance

Table 5. RECEIVER FUNCTION TABLE⁽¹⁾

DIFFERENTIAL INPUTS $V_{ID} = \text{CANH} - \text{CANL}$	STB	OUTPUT RXD	BUS STATE
$V_{ID} \geq 0.9 \text{ V}$	L	L	DOMINANT
$V_{ID} \geq 1.15 \text{ V}$	H or Open	L	DOMINANT
$0.5 \text{ V} < V_{ID} < 0.9 \text{ V}$	X	?	?
$V_{ID} \leq 0.5 \text{ V}$	X	H	RECESSIVE
Open	X	H	RECESSIVE

(1) H = high level; L = low level; X = irrelevant; ? = indeterminate; Z = high impedance

DEVICE INFORMATION
Table 6. Parametric Cross Reference With the TJA1040

TJA1040 ⁽¹⁾	PARAMETER	HVD10xx
TJA1040 DRIVER SECTION		
V _{IH}	High-level input voltage	Recommended V _{IH}
V _{IL}	Low-level input voltage	Recommended V _{IL}
I _{IH}	High-level input current	Driver I _{IH}
I _{IL}	Low-level input current	Driver I _{IL}
TJA1040 BUS SECTION		
V _{th(dif)}	Differential input voltage	Receiver V _{IT} and recommended V _{ID}
V _{hys(dif)}	Differential input hysteresis	Receiver V _{hys}
V _{O(dom)}	Dominant output voltage	Driver V _{O(D)}
V _{O(reces)}	Recessive output voltage	Driver V _{O(R)}
V _{i(dif)(th)}	Differential input voltage	Receiver V _{IT} and recommended V _{ID}
V _{O(dif0)(bus)}	Differential bus voltage	Driver V _{OD(D)} and V _{OD(R)}
I _{LI}	Power-off bus input current	Receiver I _{I(off)}
I _{O(SC)}	Short-circuit output current	Driver I _{OS(SS)}
R _{i(cm)}	CANH, CANL input resistance	Receiver R _{IN}
R _{i(def)}	Differential input resistance	Receiver R _{ID}
R _{i(cm) (m)}	Input resistance matching	Receiver R _{I (m)}
C _{i(cm)}	Input capacitance to ground	Receiver C _I
C _{i(dif)}	Differential input capacitance	Receiver C _{ID}
TJA1040 RECEIVER SECTION		
I _{OH}	High-level output current	Recommended I _{OH}
I _{OL}	Low-level output current	Recommended I _{OL}
TJA1040 SPLIT PIN SECTION		
V _O	Reference output voltage	V _O
TJA1040 TIMING SECTION		
t _{d(TXD-BUSon)}	Delay TXD to bus active	Driver t _{PLH}
t _{d(TXD-BUSoff)}	Delay TXD to bus inactive	Driver t _{PHL}
t _{d(BUSon-RXD)}	Delay bus active to RXD	Receiver t _{PHL}
t _{d(BUSoff-RXD)}	Delay bus inactive to RXD	Receiver t _{PLH}
t _{PD(TXD-RXD)}	Prop delay TXD to RXD	Device t _{LOOP1} and t _{LOOP2}
t _{d(stb-norm)}	Enable time from standby to dominant	Driver t _{en}
TJA1040 STB PIN SECTION		
V _{IH}	High-level input voltage	Recommended V _{IH}
V _{IL}	Low-level input voltage	Recommended V _{IL}
I _{IH}	High-level input current	I _{IH}
I _{IL}	Low-level input current	I _{IL}

(1) From TJA1040 Product Specification, Philips Semiconductors, 2003 February 19.

Equivalent Input and Output Schematic Diagrams

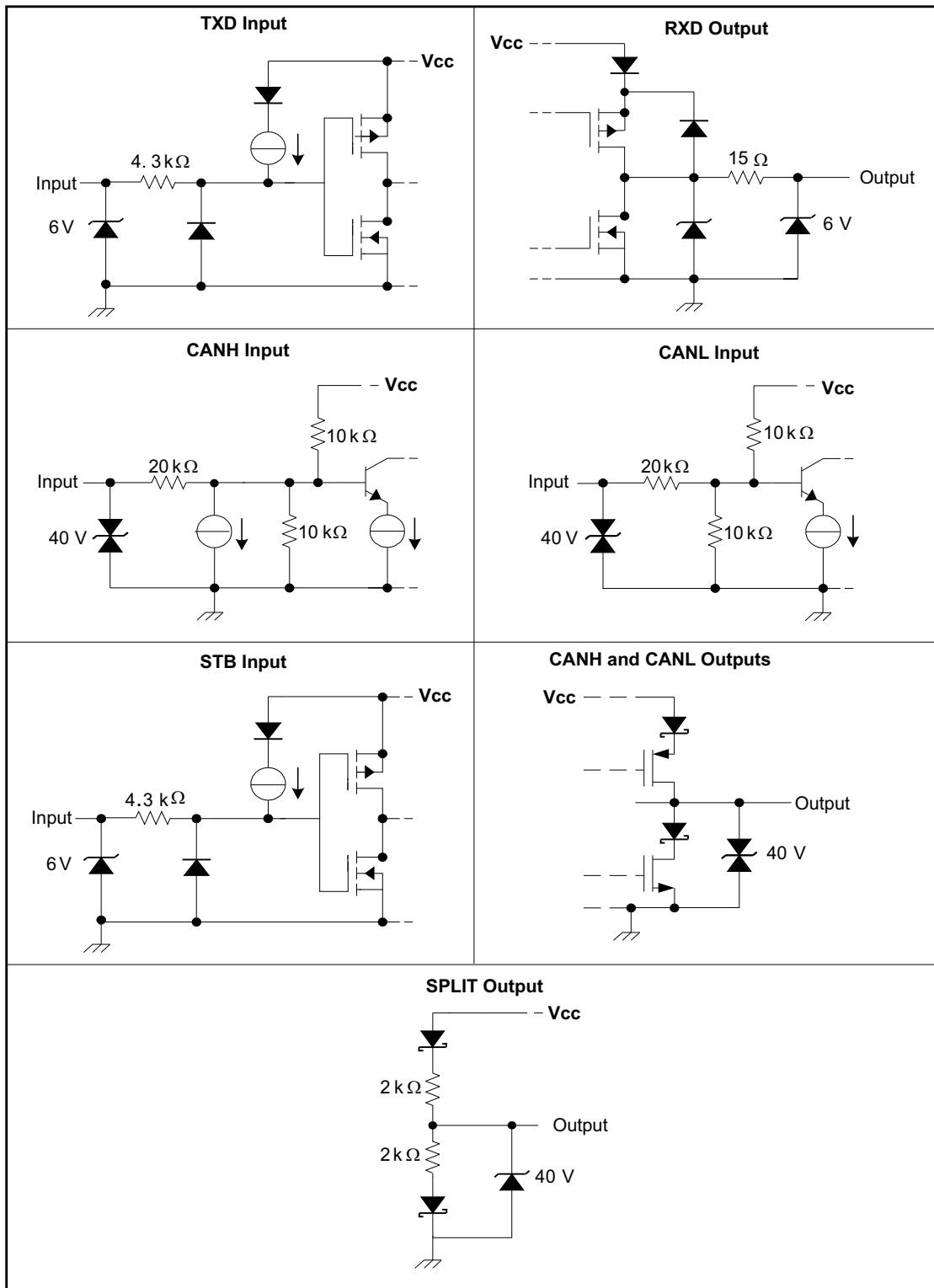

TYPICAL CHARACTERISTICS

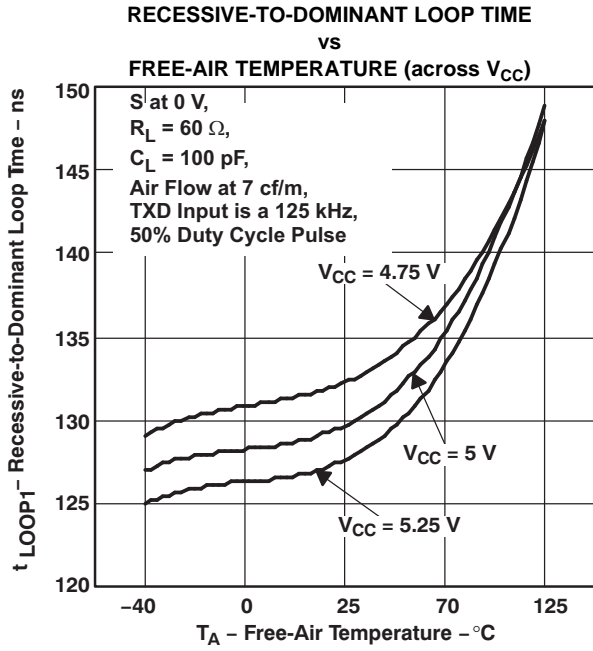

Figure 15.

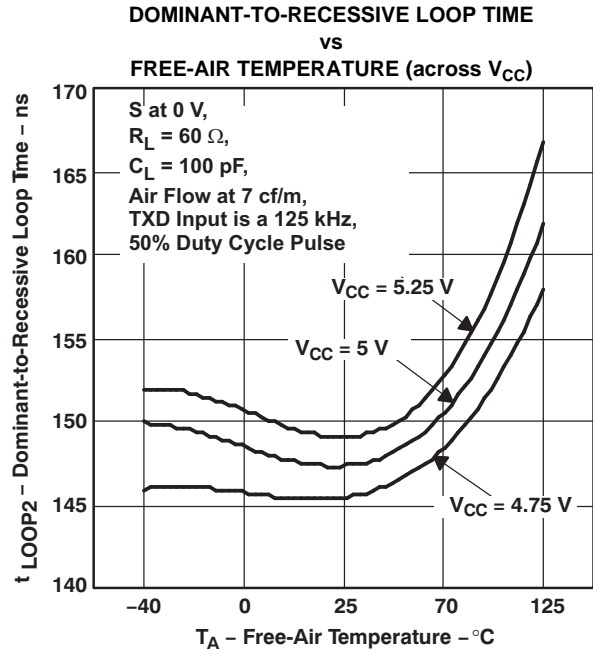

Figure 16.

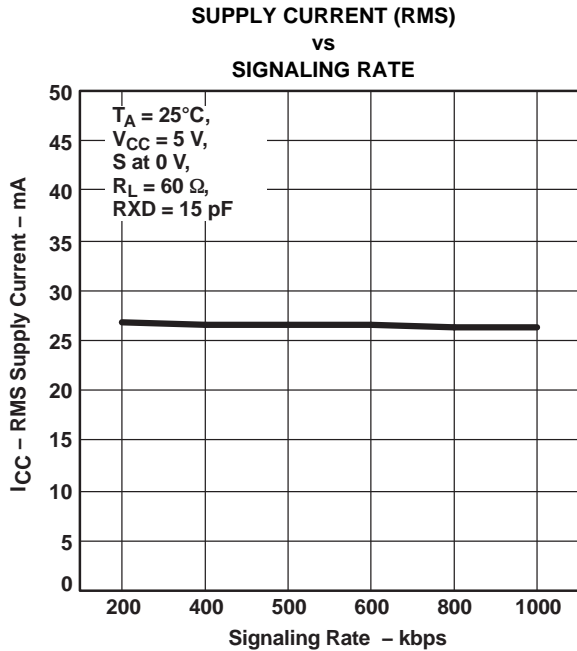

Figure 17.

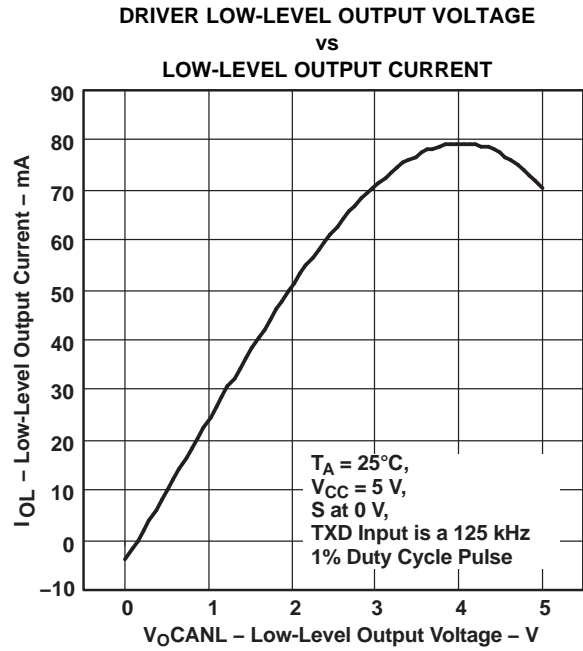

Figure 18.

TYPICAL CHARACTERISTICS (continued)

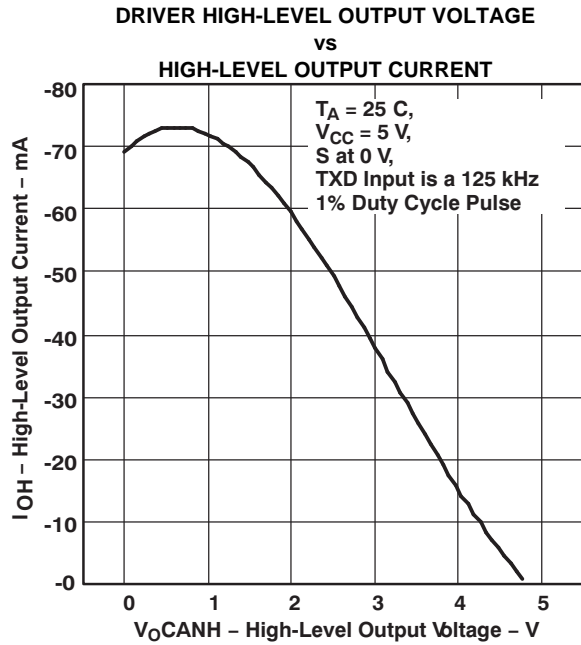

Figure 19.

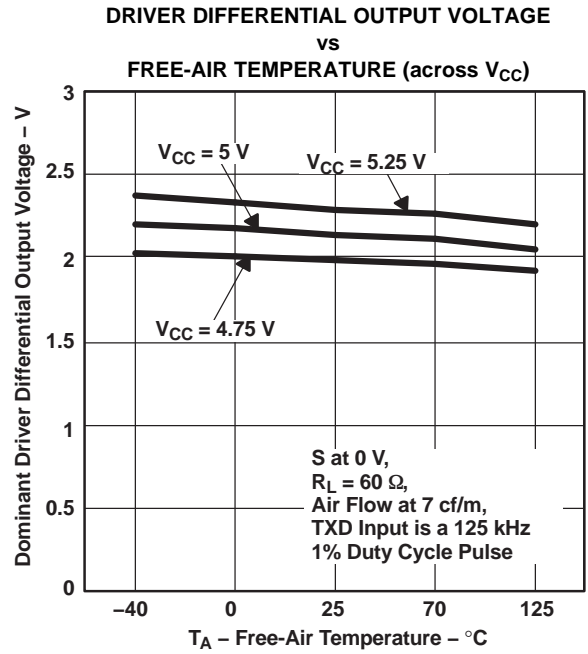

Figure 20.

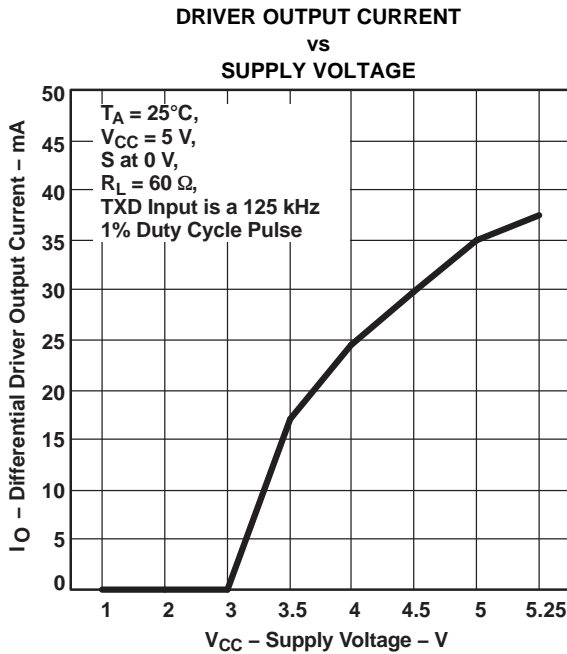

Figure 21.

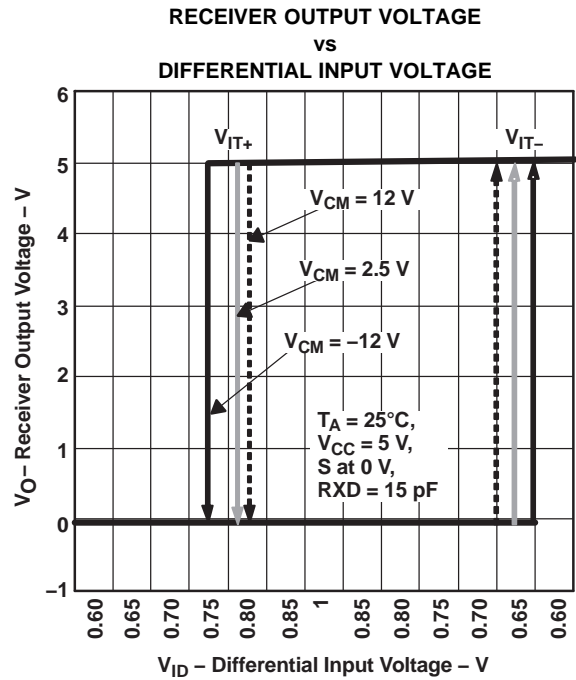

Figure 22.

TYPICAL CHARACTERISTICS (continued)

TYPICAL ELECTROMAGNETIC EMISSIONS
UP TO 50 MHz (Peak Amplitude)

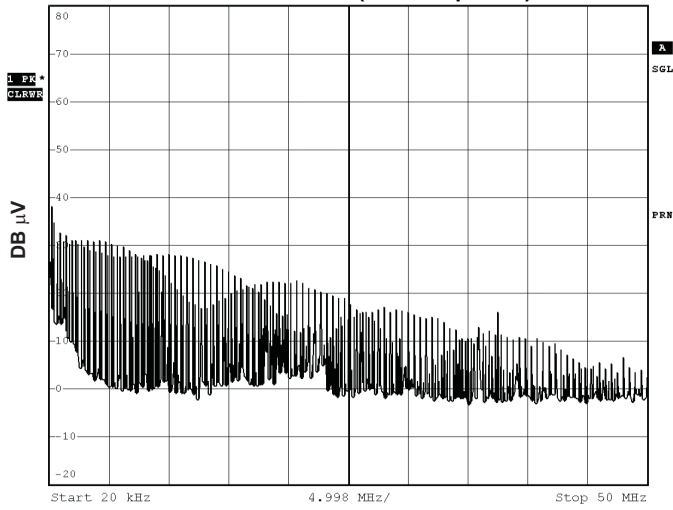

Figure 23. Frequency Spectrum of Common-Mode Emissions

TYPICAL ELECTROMAGNETIC
IMMUNITY PERFORMANCE

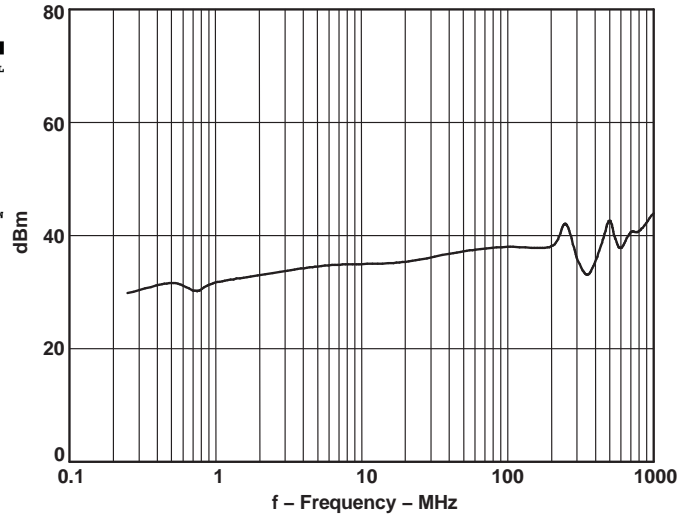

Figure 24. Direct Power Injection (DPI) Response vs Frequency

APPLICATION INFORMATION

CAN Basics

The basics of arbitration require that the receiver at the sending node designate the first bit as dominant or recessive after the initial wave of the first bit of a message travels to the most remote node on a network and back again. Typically, this “sample” is made at 75% of the bit width, and within this limitation, the maximum allowable signal distortion in a CAN network is determined by network electrical parameters.

Factors to be considered in network design include the approximately 5 ns/m propagation delay of typical twisted-pair bus cable; signal amplitude loss due to the loss mechanisms of the cable; and the number, length, and spacing of drop-lines (stubs) on a network. Under strict analysis, variations among the different oscillators in a system also need to be accounted for with adjustments in signaling rate and stub and bus length. [Table 7](#) lists the maximum signaling rates achieved with the SN65HVD1040 with several bus lengths of category 5, shielded twisted pair (CAT 5 STP) cable.

Table 7. Maximum Signaling Rates for Various Cable Lengths

Bus Length (m)	Signaling Rate (kbps)
30	1000
100	500
250	250
500	125
1000	62.5

The ISO 11898 Standard specifies a maximum bus length of 40 m and maximum stub length of 0.3 m with a maximum of 30 nodes. However, with careful design, users can have longer cables, longer stub lengths, and many more nodes to a bus. (Note: Non-standard application may come with a trade-off in signaling rate.) A large number of nodes requires a transceiver with high input impedance such as the HVD1040.

The Standard specifies the interconnect to be a single twisted-pair cable (shielded or unshielded) with 120 Ω characteristic impedance (Z_0). Resistors equal to the characteristic impedance of the line terminate both ends of the cable to prevent signal reflections. Unterminated drop-lines connect nodes to the bus and should be kept as short as possible to minimize signal reflections.

Connectors, while not specified by the standard should have as little effect as possible on standard operating parameters such as capacitive loading. Although unshielded cable is used in many applications, data transmission circuits employing CAN transceivers are usually used in applications requiring a rugged interconnection with a wide common-mode voltage range. Therefore, shielded cable is recommended in these electronically harsh environments, and when coupled with the Standard's -2 -V to 7 -V common-mode range of tolerable ground noise, helps to ensure data integrity. The HVD1040 enhances the Standard's insurance of data integrity with an extended -12 V to 12 V range of common-mode operation.

PACKAGING INFORMATION

Orderable Device	Status (1)	Package Type	Package Drawing	Pins	Package Qty	Eco Plan (2)	Lead/Ball Finish (6)	MSL Peak Temp (3)	Op Temp (°C)	Device Marking (4/5)	Samples
SN65HVD1040HD	ACTIVE	SOIC	D	8	75	Green (RoHS & no Sb/Br)	CU NIPDAU	Level-4-260C-72 HR	-55 to 175	H1040	Samples
SN65HVD1040SHKQ	ACTIVE	CFP	HKQ	8	25	TBD	AU	N / A for Pkg Type	-55 to 210	HVD1040S HKQ	Samples
SN65HVD1040SKGD3	ACTIVE	XCEPT	KGD	0	210	TBD	Call TI	N / A for Pkg Type	-55 to 210		Samples

(1) The marketing status values are defined as follows:

ACTIVE: Product device recommended for new designs.

LIFEBUY: TI has announced that the device will be discontinued, and a lifetime-buy period is in effect.

NRND: Not recommended for new designs. Device is in production to support existing customers, but TI does not recommend using this part in a new design.

PREVIEW: Device has been announced but is not in production. Samples may or may not be available.

OBSELETE: TI has discontinued the production of the device.

(2) Eco Plan - The planned eco-friendly classification: Pb-Free (RoHS), Pb-Free (RoHS Exempt), or Green (RoHS & no Sb/Br) - please check <http://www.ti.com/productcontent> for the latest availability information and additional product content details.

TBD: The Pb-Free/Green conversion plan has not been defined.

Pb-Free (RoHS): TI's terms "Lead-Free" or "Pb-Free" mean semiconductor products that are compatible with the current RoHS requirements for all 6 substances, including the requirement that lead not exceed 0.1% by weight in homogeneous materials. Where designed to be soldered at high temperatures, TI Pb-Free products are suitable for use in specified lead-free processes.

Pb-Free (RoHS Exempt): This component has a RoHS exemption for either 1) lead-based flip-chip solder bumps used between the die and package, or 2) lead-based die adhesive used between the die and leadframe. The component is otherwise considered Pb-Free (RoHS compatible) as defined above.

Green (RoHS & no Sb/Br): TI defines "Green" to mean Pb-Free (RoHS compatible), and free of Bromine (Br) and Antimony (Sb) based flame retardants (Br or Sb do not exceed 0.1% by weight in homogeneous material)

(3) MSL, Peak Temp. - The Moisture Sensitivity Level rating according to the JEDEC industry standard classifications, and peak solder temperature.

(4) There may be additional marking, which relates to the logo, the lot trace code information, or the environmental category on the device.

(5) Multiple Device Markings will be inside parentheses. Only one Device Marking contained in parentheses and separated by a "~" will appear on a device. If a line is indented then it is a continuation of the previous line and the two combined represent the entire Device Marking for that device.

(6) Lead/Ball Finish - Orderable Devices may have multiple material finish options. Finish options are separated by a vertical ruled line. Lead/Ball Finish values may wrap to two lines if the finish value exceeds the maximum column width.

Important Information and Disclaimer: The information provided on this page represents TI's knowledge and belief as of the date that it is provided. TI bases its knowledge and belief on information provided by third parties, and makes no representation or warranty as to the accuracy of such information. Efforts are underway to better integrate information from third parties. TI has taken and

continues to take reasonable steps to provide representative and accurate information but may not have conducted destructive testing or chemical analysis on incoming materials and chemicals. TI and TI suppliers consider certain information to be proprietary, and thus CAS numbers and other limited information may not be available for release.

In no event shall TI's liability arising out of such information exceed the total purchase price of the TI part(s) at issue in this document sold by TI to Customer on an annual basis.

OTHER QUALIFIED VERSIONS OF SN65HVD1040-HT :

- Catalog: [SN65HVD1040](#)
- Automotive: [SN65HVD1040-Q1](#)

NOTE: Qualified Version Definitions:

- Catalog - TI's standard catalog product
- Automotive - Q100 devices qualified for high-reliability automotive applications targeting zero defects

D (R-PDSO-G8)

PLASTIC SMALL OUTLINE

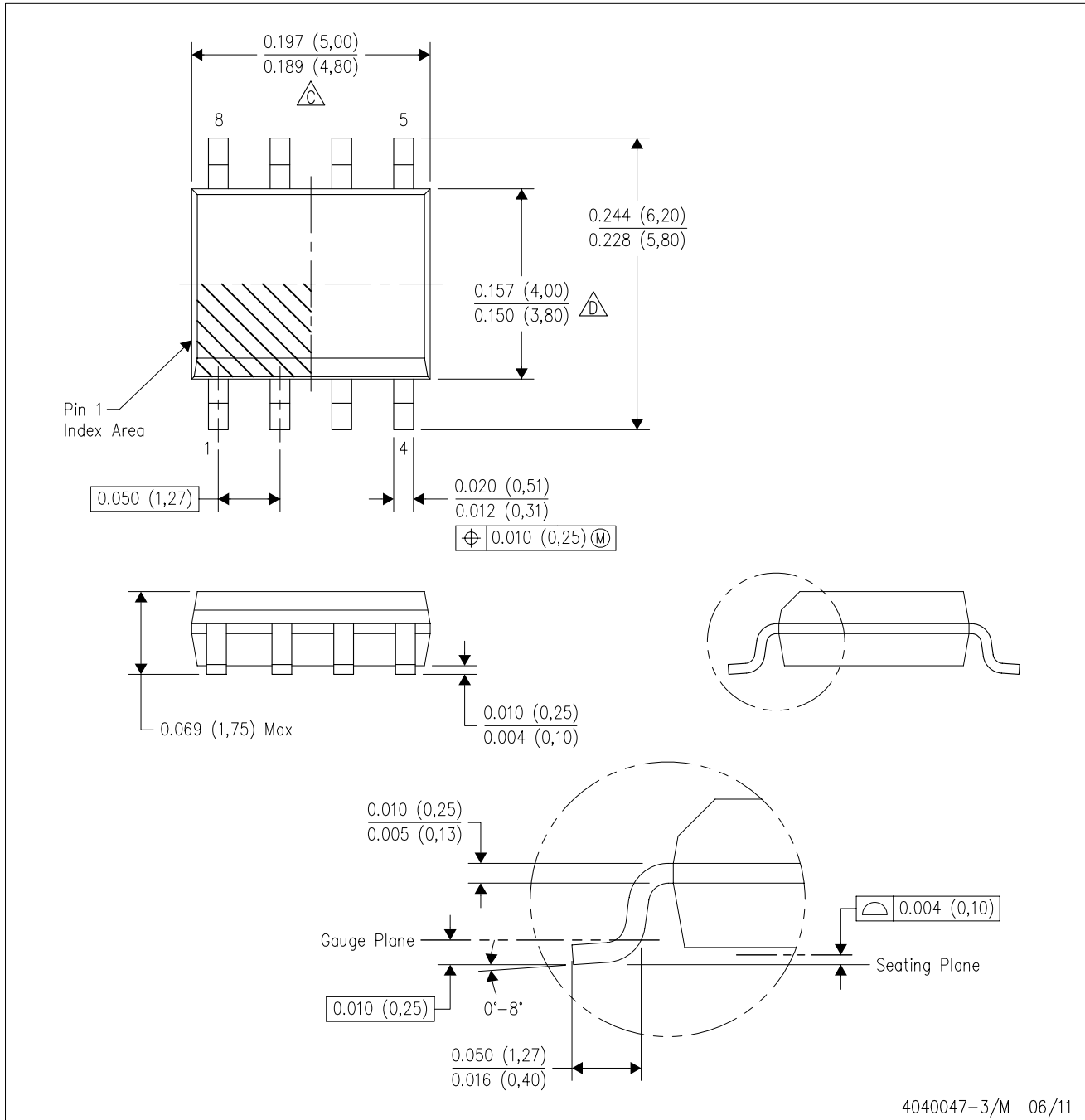

- NOTES:
- A. All linear dimensions are in inches (millimeters).
 - B. This drawing is subject to change without notice.
 - Body length does not include mold flash, protrusions, or gate burrs. Mold flash, protrusions, or gate burrs shall not exceed 0.006 (0,15) each side.
 - Body width does not include interlead flash. Interlead flash shall not exceed 0.017 (0,43) each side.
 - E. Reference JEDEC MS-012 variation AA.

MECHANICAL DATA

HKQ (R-CDFP-G8)

CERAMIC GULL WING

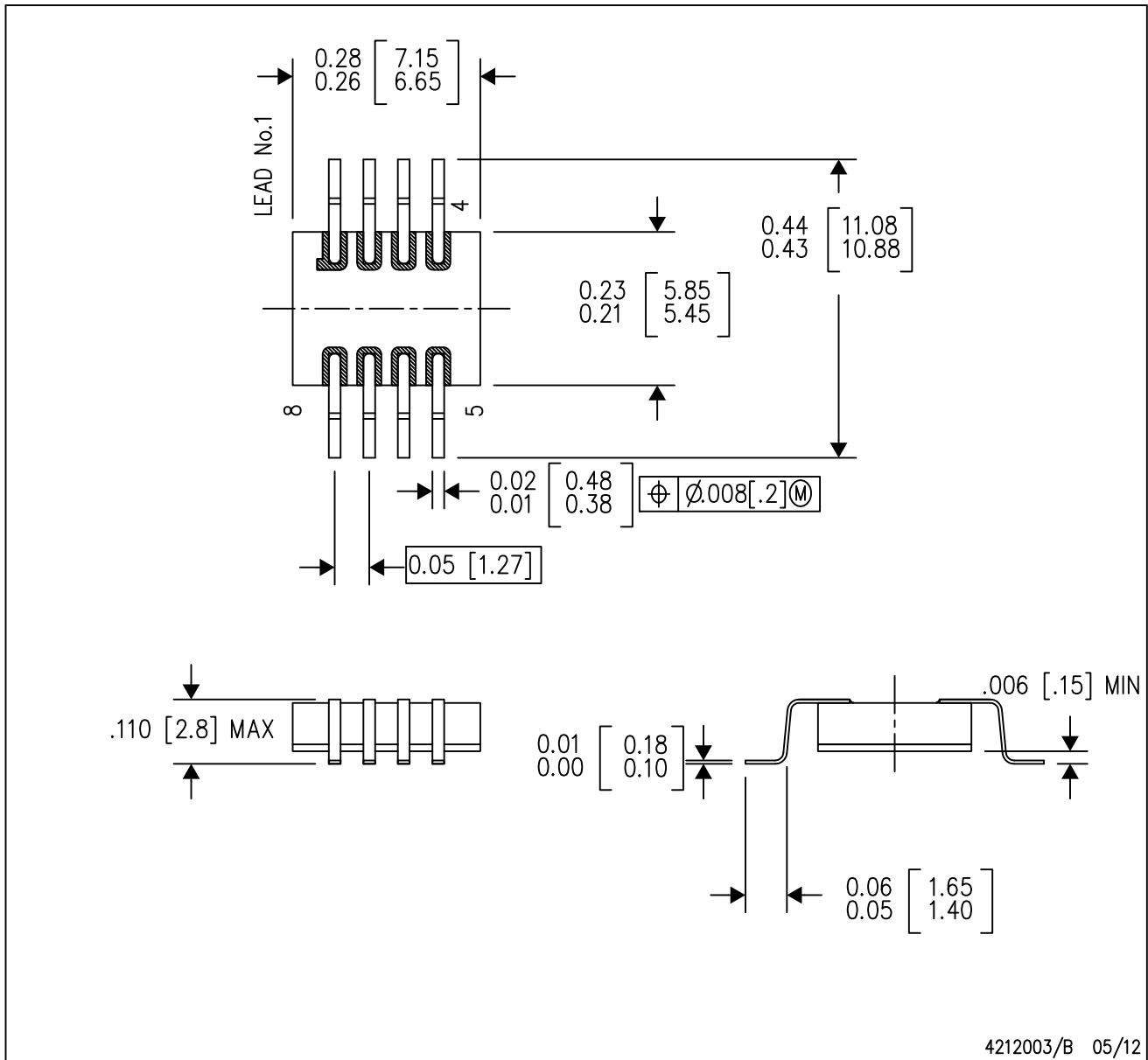

- NOTES:
- A. All linear dimensions are in inches (millimeters).
 - B. This drawing is subject to change without notice.
 - C. This package can be hermetically sealed with a metal lid.
 - D. The terminals will be gold plated.
 - E. Lid is not connected to any lead.

重要声明

德州仪器(TI) 及其下属子公司有权根据 JESD46 最新标准, 对所提供的产品和服务进行更正、修改、增强、改进或其它更改, 并有权根据 JESD48 最新标准中止提供任何产品和服务。客户在下订单前应获取最新的相关信息, 并验证这些信息是否完整且是最新的。所有产品的销售都遵循在订单确认时所提供的TI 销售条款与条件。

TI 保证其所销售的组件的性能符合产品销售时 TI 半导体产品销售条件与条款的适用规范。仅在 TI 保证的范围内, 且 TI 认为有必要时才会使用测试或其它质量控制技术。除非适用法律做出了硬性规定, 否则没有必要对每种组件的所有参数进行测试。

TI 对应用帮助或客户产品设计不承担任何义务。客户应对其使用 TI 组件的产品和应用自行负责。为尽量减小与客户产品和应用相关的风险, 客户应提供充分的设计与操作安全措施。

TI 不对任何 TI 专利权、版权、屏蔽作品权或其它与使用了 TI 组件或服务的组合设备、机器或流程相关的 TI 知识产权中授予的直接或间接版权限作出任何保证或解释。TI 所发布的与第三方产品或服务有关的信息, 不能构成从 TI 获得使用这些产品或服务的许可、授权、或认可。使用此类信息可能需要获得第三方的专利权或其它知识产权方面的许可, 或是 TI 的专利权或其它知识产权方面的许可。

对于 TI 的产品手册或数据表中 TI 信息的重要部分, 仅在没有对内容进行任何篡改且带有相关授权、条件、限制和声明的情况下才允许进行复制。TI 对此类篡改过的文件不承担任何责任或义务。复制第三方的信息可能需要服从额外的限制条件。

在转售 TI 组件或服务时, 如果对该组件或服务参数的陈述与 TI 标明的参数相比存在差异或虚假成分, 则会失去相关 TI 组件或服务的所有明示或暗示授权, 且这是不正当的、欺诈性商业行为。TI 对任何此类虚假陈述均不承担任何责任或义务。

客户认可并同意, 尽管任何应用相关信息或支持仍可能由 TI 提供, 但他们将独自负责满足与其产品及其应用中使用 TI 产品相关的所有法律、法规和安全相关要求。客户声明并同意, 他们具备制定与实施安全措施所需的全部专业技术和知识, 可预见故障的危险后果、监测故障及其后果、降低有可能造成人身伤害的故障的发生机率并采取适当的补救措施。客户将全额赔偿因在此类安全关键应用中使用任何 TI 组件而对 TI 及其代理造成的任何损失。

在某些场合中, 为了推进安全相关应用有可能对 TI 组件进行特别的促销。TI 的目标是利用此类组件帮助客户设计和创立其特有的可满足适用的功能安全性标准和要求的终端产品解决方案。尽管如此, 此类组件仍然服从这些条款。

TI 组件未获得用于 FDA Class III (或类似的生命攸关医疗设备) 的授权许可, 除非各方授权官员已经达成了专门管控此类使用的特别协议。

只有那些 TI 特别注明属于军用等级或“增强型塑料”的 TI 组件才是设计或专门用于军事/航空应用或环境的。购买者认可并同意, 对并非指定面向军事或航空航天用途的 TI 组件进行军事或航空航天方面的应用, 其风险由客户单独承担, 并且由客户独自负责满足与此类使用相关的所有法律和法规要求。

TI 已明确指定符合 ISO/TS16949 要求的产品, 这些产品主要用于汽车。在任何情况下, 因使用非指定产品而无法达到 ISO/TS16949 要求, TI 不承担任何责任。

	产品		应用
数字音频	www.ti.com.cn/audio	通信与电信	www.ti.com.cn/telecom
放大器和线性器件	www.ti.com.cn/amplifiers	计算机及周边	www.ti.com.cn/computer
数据转换器	www.ti.com.cn/dataconverters	消费电子	www.ti.com.cn/consumer-apps
DLP® 产品	www.dlp.com	能源	www.ti.com.cn/energy
DSP - 数字信号处理器	www.ti.com.cn/dsp	工业应用	www.ti.com.cn/industrial
时钟和计时器	www.ti.com.cn/clockandtimers	医疗电子	www.ti.com.cn/medical
接口	www.ti.com.cn/interface	安防应用	www.ti.com.cn/security
逻辑	www.ti.com.cn/logic	汽车电子	www.ti.com.cn/automotive
电源管理	www.ti.com.cn/power	视频和影像	www.ti.com.cn/video
微控制器 (MCU)	www.ti.com.cn/microcontrollers		
RFID 系统	www.ti.com.cn/rfidsys		
OMAP应用处理器	www.ti.com.cn/omap		
无线连通性	www.ti.com.cn/wirelessconnectivity	德州仪器在线技术支持社区	www.deyisupport.com

Mailing Address: Texas Instruments, Post Office Box 655303, Dallas, Texas 75265
Copyright © 2016, Texas Instruments Incorporated